

# Integrating the Healthcare Enterprise



5

## IHE Radiology Technical Framework Supplement

10

### Import Reconciliation Workflow (IRWF.b)

15

### Rev. 1.2 - Trial Implementation

20 Date: September 9, 2016  
Author: IHE Radiology Technical Committee  
Email: radiology@ihe.net

25

**Please verify you have the most recent version of this document. See [here](#) for Trial Implementation and Final Text versions and [here](#) for Public Comment versions.**

## Foreword

30 This is a supplement to the IHE Radiology Technical Framework V15.0. Each supplement undergoes a process of public comment and trial implementation before being incorporated into the volumes of the Technical Frameworks.

This supplement is published on September 9, 2016 for trial implementation and may be available for testing at subsequent IHE Connectathons. The supplement may be amended based on the results of testing. Following successful testing it will be incorporated into the Radiology  
35 Technical Framework. Comments are invited and can be submitted at [http://www.ihe.net/Radiology\\_Public\\_Comments](http://www.ihe.net/Radiology_Public_Comments).

This supplement describes changes to the existing technical framework documents.

“Boxed” instructions like the sample below indicate to the Volume Editor how to integrate the relevant section(s) into the relevant Technical Framework volume.

40 

<i>Amend Section X.X by the following:</i>
--

Where the amendment adds text, make the added text **bold underline**. Where the amendment removes text, make the removed text **~~bold strikethrough~~**. When entire new sections are added, introduce with editor’s instructions to “add new text” or similar, which for readability are not bolded or underlined.

45

General information about IHE can be found at: [www.ihe.net](http://www.ihe.net).

Information about the IHE Radiology domain can be found at: [ihe.net/IHE\\_Domains](http://ihe.net/IHE_Domains).

Information about the organization of IHE Technical Frameworks and Supplements and the process used to create them can be found at: [http://ihe.net/IHE\\_Process](http://ihe.net/IHE_Process) and  
50 <http://ihe.net/Profiles>.

The current version of the IHE Radiology Technical Framework can be found at: [http://www.ihe.net/Technical\\_Frameworks](http://www.ihe.net/Technical_Frameworks).

## CONTENTS

55	Introduction to this Supplement.....	7
	Open Issues and Questions .....	7
	Closed Issues .....	7
	<b>Volume 1 – Integration Profiles.....</b>	<b>12</b>
60	2.1 Dependencies among Integration Profiles .....	12
	2.1.19 Import Reconciliation Workflow (IRWF) - DEPRECATED .....	13
	2.1.nn Import Reconciliation Workflow (IRWF.b).....	13
	2.3 Actor Descriptions .....	14
	2.4 Transaction Descriptions.....	17
65	21 Import Reconciliation Workflow (IRWF.b) .....	20
	21.1 Actors/Transactions.....	20
	21.1.1 Actor Descriptions and Actor Profile Requirements.....	23
	21.1.1.1 Importer Actor .....	23
	21.2 Import Reconciliation Workflow Integration Profile Options .....	23
70	21.2.1 Scheduled Import Option .....	24
	21.2.2 Unscheduled Import Option .....	24
	21.2.3 Automated Order Placement and Scheduling Option. ....	24
	21.2.4 Import Instruction Handling Option.....	25
	21.2.5 Billing and Material Management Option .....	26
75	21.3 Integration Workflow Process Flow .....	26
	21.3.1 Import Process Flow.....	26
	21.3.1.1 Use Cases.....	27
	21.3.1.2 Imported Objects Storage Process Flow.....	29
	21.3.1.23 Scheduled Import Process Flow .....	29
80	21.3.1.23.1 Scheduled Import Data Reconciliation.....	32
	21.3.1.34 Unscheduled Import Process Flow .....	33
	21.3.1.34.1 Unscheduled Import Data Reconciliation.....	37
	21.3.1.5 Automated Order Placement and Scheduling Process Flow .....	37
	21.3.1.5.1 Automated Order Placement and Scheduling Data Reconciliation.....	40
85	21.3.1.6 Import Instruction Handling Process Flow.....	41
	21.3.2 Import Exception Management Workflow .....	43
	21.3.3 Architecture .....	43
	<b>Volume 2 – Transactions.....</b>	<b>47</b>
	4.4 Procedure Scheduled.....	47
90	4.4.4.1.2 Message Semantics.....	47
	4.4.4.1.2.1 Message Semantics (HL7 <sup>®</sup> v2.3.1) .....	47
	4.4.4.1.2.2 Message Semantics (HL7 v2.5.1 Option) .....	48
	4.4.4.2 Expected Actions.....	48
	4.4.4.2.2 Import Instruction Handling Option .....	48
95	4.5 Query Modality Worklist .....	49
	4.5.4.2.2.1 Scheduled Protocol Sequence for Import .....	49

	4.11 Images Availability Query .....	51
	4.11.1 Scope .....	51
	4.11.2 Use Case Roles .....	52
100	4.11.3 Referenced Standards .....	52
	4.11.4 Interaction Diagram .....	53
	4.11.4.1 Query Image Availability .....	54
	4.11.4.1.1 Trigger Events .....	54
	4.11.4.1.2 Message Semantics .....	54
105	4.11.4.1.3 Expected Actions .....	55
	4.13 Procedure Update .....	56
	<b>Volume 3 – Transactions .....</b>	<b>57</b>
	4.59 Import Procedure Step In Progress .....	57
	4.59.1 Scope .....	57
110	4.59.2 Use Case Roles .....	57
	4.59.3 Referenced Standards .....	58
	4.59.4 Interaction Diagram .....	58
	4.59.4.1 Procedure Step In Progress Message .....	59
	4.59.4.1.1 Trigger Event .....	59
115	4.59.4.1.2 Message Semantics .....	59
	4.59.4.1.2.1 Patient/Procedure/Scheduled Procedure Step Information .....	60
	4.59.4.1.2.2 Required Attributes .....	60
	4.59.4.1.2.3 Relationship between Scheduled and Performed Procedure Steps and the Imported DICOM Composite Object .....	60
120	4.59.4.1.3 Expected Actions .....	62
	4.59.4.1.3.1 Import Instruction Handling Option .....	62
	4.61 Imported Objects Stored .....	63
	4.61.1 Scope .....	63
	4.61.2 Use Case Roles .....	63
125	4.61.3 Referenced Standards .....	63
	4.61.4 Interaction Diagram .....	64
	4.61.4.1 <del>Evidence</del> Imported Objects Stored .....	64
	4.61.4.1.1 Trigger Events .....	64
	4.61.4.1.1.1 UIDs .....	64
130	4.61.4.1.2 Message Semantics .....	64
	4.61.4.1.2.1 Original Attributes Sequence .....	65
	4.61.4.1.2.2 Contributing Equipment Sequence .....	66
	4.61.4.1.3 Expected Actions .....	67
	4.61.4.1.3.1 Import Instruction Handling Option .....	67
135	4.61.4.1.3.1 DICOM Storage SOP Classes .....	67
	4.76 Query For Study .....	68
	4.76.1 Scope .....	68
	4.76.2 Use Case Roles .....	68
	4.76.3 Referenced Standards .....	68

140	4.76.4 Interaction Diagram.....	69
	4.76.4.1 Query For Study .....	69
	4.76.4.1.1 Trigger Events .....	69
	4.76.4.1.2 Message Semantics.....	69
	4.76.4.1.3 Expected Actions .....	72
145	4.76.5 Security Considerations.....	73
	4.76.5.1 Security Audit Considerations.....	73
	4.77 Query For Patient ID.....	74
	4.77.1 Scope .....	74
	4.77.2 Use Case Roles.....	74
150	4.77.3 Referenced Standards.....	74
	4.77.4 Interaction Diagram.....	75
	4.77.4.1 Query For Patient ID .....	75
	4.77.4.1.1 Trigger Events .....	75
	4.77.4.1.2 Message Semantics.....	75
155	4.77.4.1.3 Expected Actions .....	76
	4.77.5 Security Considerations.....	77
	4.77.5.1 Security Audit Considerations.....	77
	4.78 Request Filling of Order .....	78
	4.78.1 Scope .....	78
160	4.78.2 Use Case Roles.....	78
	4.78.3 Referenced Standards.....	78
	4.78.4 Interaction Diagram.....	79
	4.78.4.1 Order Management – Order Filled from Importer .....	79
	4.78.4.1.1 Trigger Events .....	79
165	4.78.4.1.2 Message Semantics.....	79
	4.78.4.1.2.1 MSH Segment.....	80
	4.78.4.1.2.2 PID Segment .....	80
	4.78.4.1.2.3 PV1 Segment .....	81
	4.78.4.1.2.4 ROL Segmen.....	81
170	4.78.4.1.2.5 ORC Segment .....	82
	4.78.4.1.2.6 TQ1 Segment .....	83
	4.78.4.1.2.7 OBR Segment .....	83
	4.78.4.1.2.8 IPC Segment .....	85
	4.78.4.1.3 Expected Actions .....	86
175	4.78.4.1.3.1 Automated Order Placement and Scheduling Option.....	86
	4.78.5 Security Considerations.....	86
	4.78.5.1 Security Audit Considerations.....	86
	4.79 Import Instructions Request .....	87
	4.79.1 Scope .....	87
180	4.79.2 Use Case Roles.....	87
	4.79.3 Referenced Standards.....	87
	4.79.4 Interaction Diagram.....	88

	4.79.4.1 Order Management – Import Instructions from Importer .....	88
	4.79.4.1.1 Trigger Events .....	88
185	4.79.4.1.2 Message Semantics .....	88
	4.79.4.1.2.1 MSH Segment .....	89
	4.79.4.1.2.2 PID Segment .....	89
	4.79.4.1.2.3 PV1 Segment .....	90
	4.79.4.1.2.5 ORC Segment .....	90
190	4.79.4.1.2.6 TQ1 Segment .....	91
	4.79.4.1.2.7 OBR Segment .....	91
	4.79.4.1.2.8 IPC Segment .....	93
	4.79.4.1.3 Expected Actions .....	94
	4.79.4.1.3.1 Import Instruction Handling Option .....	94
195	A.5 Imported Object Integration – Critical Attributes .....	95
	Appendix K – Import Reconciliation Workflow Import Instruction Handling Option .....	109
	K.1 DSS/Order Filler Requirements .....	109
	K.1.1 DSS/Order Filler User Selectable Import Instruction Code Mapping .....	109
	K.2 Importer Requirements .....	109
200	K.2.1 Importer Institution Name Mapping .....	109
	K.2.1.1 Importer Configurable Institution Name Mapping for Objects Received Over the Network .....	110
	K.2.1.2 Importer Message Semantics when Sending SOP Instances .....	110
	K.2.2 Importer Import Instruction Code Setting .....	111
205	K.2.2.1 Importer Configurable Import Instruction Code Mapping for Objects Received Over the Network .....	111
	K.3 Image Manager Requirements .....	111
	K.3.1 Image Manager Import Instruction Code Handling .....	111

210 **Introduction to this Supplement**

This supplement deprecates the previous Import Reconciliation Workflow Profile of the IHE Radiology Technical Framework and replaces it with a new version of this Profile (IRWF.b). It changes the Import Reconciliation Workflow Profile so that the Scheduled Import and Unscheduled Import methods of import are now mandatory rather than defined options.

215 Unscheduled Import is revised to require additional functionality by actors. It also defines additional options to better automate import of foreign studies, and to specify how import instructions can be set and handled. This supplement proposes changes to Volumes 1, 2 and 3 of the IHE Radiology Technical Framework.

220 **Open Issues and Questions**

#	Issue/ (Answer)
1.	None

**Closed Issues**

#	Issue/ (Answer)
1.	<p><b>Should the new Importer Order Filler Transaction [RAD-78] have both HL7<sup>®1</sup> v2.3.1 and v2.5.1 options? It triggers Filler Order Management [RAD-4] transactions between the Order Filler and Order Placer which in CP213 supports both options so it would seem inconsistent to have the new transaction only support HL7v2.5.1.</b></p> <p><i>Decision is for it to only have the HL7v2.5.1 option.</i></p>
2.	<p><b>The original IRWF Scheduled and Unscheduled Import options did not first check to see if the objects have already been imported, so why should the new Unscheduled Import method require the Importer to check using the Query for Study [RAD-76] and Images Availability Query [RAD-11]?</b></p> <p><i>The rationale is that the new Automated Order Placement and Scheduling Option can actually result in the creation of newly scheduled orders. So it is important to prevent the needless creation of orders for data that has actually already been imported.</i></p>
3.	<p><b>There are existing requirements for the DSS/Order Filler to set the Table 4.5-4: Import Instruction Codes but the wording is rather weak (see 4.5.4.2.2.1). Should any changes be made?</b></p> <p><i>Decision to add DSS Order Filler to Import Instruction Handling Option. Specify that it shall allow user selectable and/or configurable setting of these codes.</i></p>

---

<sup>1</sup> HL7 is the registered trademark of Health Level Seven International.

#	Issue/ (Answer)
4.	<p><b>There is nothing mandating that a DSS/Order Filler shall supply the Import Instruction Codes in the Procedure Scheduled [RAD-4] or Procedure Updated [RAD-13] transactions. Should there be? And should there be any wording about what an Image Manager/Archive should do with these codes?</b></p> <p><i>Decision to add language that the Import Instruction Codes shall also be conveyed in RAD-4 and RAD-13.</i></p>
5.	<p><b>Should this Supplement use the new template table for Actor Grouping? (See 21.2 and 21.3 in draft document.)</b></p> <p><i>Do not use the new Actor Grouping table in this Supplement.</i></p>
6.	<p><b>Should Importer be allowed to cancel or update orders?</b></p> <p><i>No. This would raise concerns about race conditions and how conflicting updates/cancellations coming from the Importer and DSS/Order Filler shall be handled. Instead, only allow the DSS/Order Filler to cancel or update orders.</i></p>
7.	<p><b>The existing Table 21.1-1 IRWF – Actors and Transactions does not list Query Modality Worklist for the DSS/Order Filler. Is this just a mistake or is it because IRWF requires support for SWF?</b></p> <p><i>It should be listed because the transaction has specific requirements regarding Import Instruction Codes if the DSS/Order Filler is communicating with an Importer. It should be a Required transaction because SWF requires it.</i></p>
8.	<p><b>The Imported Objects Stored transaction does not require that the Patient ID and Accession Number Assigning Authority attributes be sent in the imported objects. At the very least it should require that if these are sent they be consistent with these values. i.e., an Importer cannot just localize these attributes and leave original Assigning Authority attribute values as-is.</b></p> <p><i>Decision is to address this issue in this Supplement as it will be replacing the existing IRWF Profile rather than just adding new options.</i></p>
9.	<p><b>The existing text in RAD TF-1, 21.3.1 Import Exception Management Workflow is incomplete. It ends with the sentence “The following numbered items list exception cases that shall be supported by the actors listed in each item.”, but there are no following numbered items.</b></p> <p><i>Decision was made to eliminate this sentence. The exception handling actions that shall be supported by actors are specified in the individual transactions.</i></p>



#	Issue/ (Answer)
10.	<p><b>Section 4.78.4.1.2.6, TQ1 Segment, specifies that the Study Date/Time taken from the DICOM object headers shall be used as the Start Date/Time.</b></p> <p><b>However, Study Date (0008,0020) and Study Time (0008,0030) are actually Type 2 in DICOM objects so there could be no values from the imported objects. What values shall be used if these are empty in the DICOM objects?</b></p> <p><i>Decision is that the current date/time (at the time of import) be used.</i></p>
11.	<p><b>Should a process flow order be mandated for how the default IRWF.b Scheduled Import and Unscheduled Import shall be combined?</b></p> <p><b>If an Importer is deployed such that it requires user interaction then it would make sense to require that it perform the Worklist query first, and only perform the Patient Matching transactions if a suitable match is not found. On the other hand, if an Importer is supporting some automated functionality, such as part of some automated pre-fetch application then it makes sense to perform the Patient Matching transactions first to resolve the local patient id before querying to see if there is a corresponding scheduled procedure step.</b></p> <p><i>Decision is to make the order up to the application. IRWF.b does not mandate a particular order for process flow when combining the support for the default behavior and Patient Matching.</i></p>

#	Issue/ (Answer)
12.	<p><b>For the Automated Order Placement and Scheduling Option, how should the DSS/Order Filler know to match a Request Filling of Order from the Importer to a placed order if one already exists? The Importer will not know the Placer Order Number used by the Order Placer.</b></p> <p><b>The text did define support for this ‘contracted order’ scenario but did not define a matching algorithm.</b></p> <p><b>Several options were considered:</b></p> <ul style="list-style-type: none"> <li>• <b>Leave as-is</b></li> <li>• <b>Define a matching algorithm (Patient ID, modality, etc.).</b></li> <li>• <b>Define a mechanism for the Importer to query the Order Filler for placed orders. This was originally attempted in developing this Supplement but a satisfactory method using DICOM or HL7 was not found.</b></li> <li>• <b>Eliminate the ‘contracted order’ handling method from this Supplement</b></li> </ul> <p><i>Decision was to eliminate the ‘contracted order’ handling method from this Supplement. If we want to add it in the future then we should either define specific messaging so that the Importer can query for ‘contracted orders’ or define a specific algorithm that must be supported by the DSS/OF. Otherwise it will be very difficult to test at Connectathons if vendors can defined their own behavior, and also difficult for customers to understand (i.e.” yes, our product supports that specific workflow and here is our particular algorithm for doing it ...” goes well beyond what can be conveyed in an IHE Integration Statement).</i></p>
13.	<p><b>The Unscheduled Import method of import mandates three different query mechanisms for reconciling the patient demographics:</b></p> <ul style="list-style-type: none"> <li>• <b>PIX so that the local patient id can be quickly ascertained if PIX is supported in the environment</b></li> <li>• <b>PDQ in case the patient id assigning authority of the imported objects is not in the PIX Affinity Domain, there is no patient id (or its assigning authority cannot be determined), or there is no PIX Manager in the environment</b></li> <li>• <b>Query for Patient ID as a purely DICOM fallback mechanism if neither PIX or PDQ is supported.</b></li> </ul> <p><b>Does this put too much of an implementation burden on the Importer? If so then what subset of mechanisms should remain in the Patient Matching Option?</b></p> <p><i>Decision was to keep all three transactions as being required.</i></p>

#	Issue/ (Answer)
14.	<p><b>Can the Import Instruction Handling Option for the Image Manager specify default behavior so that some of the Import Instruction Codes can be eliminated? For example, should an Image Manager/Archive choose to always archive the imported objects unless explicitly told not to (and thus could the “To be archived” code be removed?</b></p> <p><i>Decision is to not define Import Instruction Handling Option as default behavior expectations will be very site dependent.</i></p>
15.	<p><b>Should the Images Availability Query [RAD-11] be modified to specify that when used by the Importer for the Patient Matching Option, the Importer shall specify the full list of Instance UIDs being searched for, rather than leaving the Instance UID blank and checking the returned Instance UIDs? The transaction currently allows the Importer to use either method to determine whether or not particular SOP Instances have already been imported.</b></p> <p><i>Decision is to leave as-is as the Image Manager will have to support both in order to be DICOM conformant and to conform to the transaction. The Importer implementation can then choose to use whatever approach it feels is more efficient.</i></p>
16.	<p><b>What should the Importer do if the local Patient ID cannot be determined because one does not exist?</b></p> <p><i>Decision is to leave the current text as-is, which requires that the patient be registered prior to import. A future possible work item proposal or CP will be to address importation of unregistered patients, for example by adding Importer as an actor to the Patient Information Reconciliation, PIR, Profile.</i></p>
17.	<p><b>Think of adding an X.7 section based on new template (i.e., talk about IOCM for replacing DICOM SOP Instances).</b></p> <p><i>Decision is to address this in the future. This could be added to IRWF.b text while it is in Trial Implementation as it will not be normative text.</i></p>
18.	<p><b>Two additional Import Instruction Codes were suggested:</b></p> <ul style="list-style-type: none"> <li>• <b>“To be sequestered for legal review”</b></li> </ul> <p><i>Could not reach a decision on how an Image Manager/Archive should handle this. Can address using a future CP.</i></p> <ul style="list-style-type: none"> <li>• <b>“To be sequestered for review of unregistered patient”</b></li> </ul> <p><i>Decision was not to add this as this code is related to Closed Issue 16. Import of data for unregistered patients is left as a future possible work item.</i></p>

# Volume 1 – Integration Profiles

## 225 2.1 Dependencies among Integration Profiles

*Modify the dependencies in Table 2-1 (within RAD TF-1:2) as follows*

**Table 2-1: Integration Profiles Dependencies**

Integration Profile	Depends on	Dependency Type	Comments
Import Reconciliation Workflow ( <b><u>IRWF.b</u></b> )	Scheduled Workflow	Required for Workflow (including <del>Scheduled Import Option</del> <b><u>Automated Order Placement and Scheduling Option</u></b> )	Support the workflow related transactions of Scheduled Workflow.
	Patient Demographics Query [ITI]	<del>Required for Unscheduled Import Option</del> <b><u>IRWF.b Importer is required to be grouped with a Patient Demographics Consumer in the ITI PDO Profile.</u></b>	Patient Demographic information is obtained using Patient Demographic Query.
	<b><u>Patient Identifier Cross-referencing [ITI]</u></b>	<b><u>IRWF.b Importer is required to be grouped with a Patient Identifier Cross-reference Consumer in the ITI PIX Profile.</u></b>	<b><u>Patient identifier cross-referencing is obtained using PIX Query or PIX Update Notification.</u></b>

230

*Modify the IRWF Profile overview subsection (TF-1: 2.1.19) as follows:*

### **2.1.19 Import Reconciliation Workflow (IRWF) - DEPRECATED**

235 ~~The Import Reconciliation Workflow Integration Profile (IRWF) specifies how data Importers obtain local demographics, coerce patient and procedure attribute values in the imported data and report progress/status of the importation process. The Profile complements the Scheduled Workflow Profile by using the existing workflow mechanisms for notification and storage of imported Evidence Objects.~~

240 This profile has been superseded by the Import Reconciliation Workflow (IRWF.b) Integration Profile. See Sections 2.1.nn and 21 for details on the replacement profile.

*Add the following new IRWF.b Profile overview subsection (TF-1: 2.1.nn) as follows:*

### **2.1.nn Import Reconciliation Workflow (IRWF.b)**

245 The Import Reconciliation Workflow Integration Profile (IRWF.b) specifies how data Importers obtain local demographics, coerce patient and procedure attribute values in the imported data and report progress/status of the importation process. This profile complements the Scheduled Workflow Profile by using the existing workflow mechanisms for notification and storage of imported Evidence Objects.

### 2.3 Actor Descriptions

250

*Delete the Patient Demographics Supplier as it is no longer defined as an actor for any Radiology Technical Framework Profiles or transactions.*

255

**~~Patient Demographics Supplier—A repository of patient information that can be searched on demographic related fields. This actor is defined in the ITI Technical Framework.~~**

*Modify Table 2.3-1 by changing the IRWF Profile to be IRWF.b, and specifying that the Order Placer is an Actor for the IRWF.b Profile. Remove the Patient Demographic Supplier as it will now be specified as a dependency rather than as an actual actor for IRWF.b.*

260

**Table 2.3-1: Integration Profile Actors**

Integration Profile Actor	SWF	PIR	PWF	RWF	CHG	CPI	PGP	KIN	ED	NM	SINR	PDI	ARI	XDS-I	MAMMO	IRWF <b><u>b</u></b>	TCE
Acq. Modality	X	X			X	X	X	X	X	X					X		
ADT Patient Reg.	X	X			X												
Charge Processor					X												
Display (ITI)												X					
Document Consumer														X			
Document Registry														X			

IHE Radiology Technical Framework Supplement – Import Reconciliation Workflow (IRWF.b)

Integration Profile Actor	SWF	PIR	PWF	RWF	CHG	CPI	PGP	KIN	ED	NM	SINR	PDI	ARI	XDS-I	MAMMO	IRWF_b	TCE
Document Repository														X			
DSS/OF	X	X	X	X	X		X									X	
Enterprise Rep. Repository											X						
Evidence Creator	X		X		X	X		X	X	X					X		
Export Manager																	X
Export Selector																	X
Ext. Rep. Access											X		X				
Image Archive	X	X	X	X		X	X	X	X	X			X		X	X	
Image Display	X		X			X		X	X	X		X	X		X		
Image Manager	X	X	X	X		X	X	X	X	X			X		X	X	
Imaging Document Consumer														X			
Imaging Document Source														X			
Importer					X												X
Order Placer	X	X															X
<b>Patient Demographics Supplier</b>																	X

IHE Radiology Technical Framework Supplement – Import Reconciliation Workflow (IRWF.b)

Integration Profile Actor	SWF	PIR	PWF	RWF	CHG	CPI	PGP	KIN	ED	NM	SINR	PDI	ARI	XDS-I	MAMMO	IRWF_b	TCE
Portable Media Creator												X					
Portable Media Importer												X					
Post-Processing Manager			X		X												
PPS Manager	X	X		X	X		X									X	
Print Composer						X						X			X		
Print Server						X									X		
Receiver																	X
Report Creator				X					X		X						
Report Manager		X		X	X						X						
Report Reader				X							X	X	X				
Report Repository		X									X		X				



## 2.4 Transaction Descriptions

*Modify the Images Availability Query transaction description and add new transactions. Also update Table 2.4-1 to reflect these changes.*

- 265     **11. Images Availability Query – ~~The Department System Scheduler/Order Filler and Report Manager a~~Queries** the Image Manager if a particular image or image series is available.  
      ...
- 270     **67. Query For Study – Queries the Image Manager/Archive to obtain the details of prior imported data, if any.**
- 77. Query for Patient ID - Queries the Image Manager/Archive to obtain the local patient identifier corresponding to the patient demographics in objects to be imported.**
- 275     **78. Request Filling of Order – Schedules a procedure step to import data.**
- 79. Import Instructions Request –vSends import instructions from an Importer to an Image Manager/Archive.**

The following table shows which transactions are used in which Integration Profiles.

280

**Table 2.4-1: Integration Profile Transactions**

Integration Profile Transaction	SWF	PIR	PWF	RWF	CHG	CPI	PGP	KIN	ED	NM	SINR	PDI	ARI	XDS-I	MAMMO	IRWF.b	TCE
<del>Patient Demographics Query [RF-21]</del>	X															X	
Filler Order [RAD-3]	X															X	
Images Availability Query [RAD-11]	X	X	X	X												X	
<u>Query For Study [RAD-76]</u>																X	
<u>Query For Patient ID [RAD-77]</u>																X	
<u>Request Filling of Order [RAD-78]</u>																X	
<u>Import Instructions Request [RAD-79]</u>																X	

*Add the following to TF vol 1, Section 2.5 Product Implementations*

- The Importer is generic in terms of not defining a specific transport mechanism for the Evidence Objects it imports. It may be necessary for the Importer to be grouped with additional Actors to support specific transport mechanisms. For example, to support import from PDI Media, the Importer must be grouped with the Portable Media Importer.
- **The Importer supporting Import Reconciliation Workflow shall be grouped with an ITI PIX Patient Identifier Cross-reference Consumer thereby supporting the Consumer’s transactions for querying a PIX Patient Identifier Cross-reference Manager as defined in ITI PIX. It shall support the ability to query for the local patient identifier for imported objects by supporting the PIX Query [ITI-9] transaction.**
- **The Importer supporting Import Reconciliation Workflow shall be grouped with an ITI PDQ Patient Demographics Consumer thereby supporting the Consumer’s transactions for querying a PDQ Patient Demographic Supplier as defined in ITI PDQ. It shall support the ability to query for the local patient identifier and demographics for imported objects by supporting the PDQ Patient Demographics Query [ITI-21] transaction.**

285

290

295

300

*Modify RAD TF-1:21 as follows*

## **21 Import Reconciliation Workflow (IRWF.b)**

305 **IMPORTANT: The Import Reconciliation Workflow (IRWF) Integration Profile (originally found here) has been deprecated and is replaced by a functionally equivalent profile called Import Reconciliation Workflow (IRWF.b), which is described in the remainder of this section.**

310 The *Import Reconciliation Workflow Integration Profile (IRWF.b)* specifies both the data and workflow requirements for importing existing Evidence Objects and importing Hardcopy from an external Enterprise. ~~Worklists and Patient Demographics Query~~ Various transactions are provided as mechanisms to provide local patient and procedure information to be used in the process of reconciling the imported patient/procedure information. Procedure Step Completed messages enable subsequent workflow steps to occur based on the importation of the Evidence Objects.

315 Reconciling critical patient demographics (e.g., Patient Name, Patient ID) and order/procedure Information (e.g., Accession Number) is an important part of the importation process since the local Enterprise will typically have different identifiers (for patient, orders, etc.) from the Enterprise that created the Evidence Objects or Hardcopy being imported.

When the attribute values must be changed, this profile provides a mechanism to preserve a copy of the original values inside the imported DICOM<sup>®2</sup> Composite Objects.

320 This profile also makes it possible to determine whether images, reports and other evidence objects associated with a particular import have been stored (archived) and are available to subsequent workflow steps, such as post-processing and reporting.

### **21.1 Actors/Transactions**

Figure 21.1-1 diagrams the actors involved with this profile and the transactions between them.

---

<sup>2</sup> DICOM is the registered trademark of the National Electrical Manufacturers Association for its standards publications relating to digital communications of medical information.

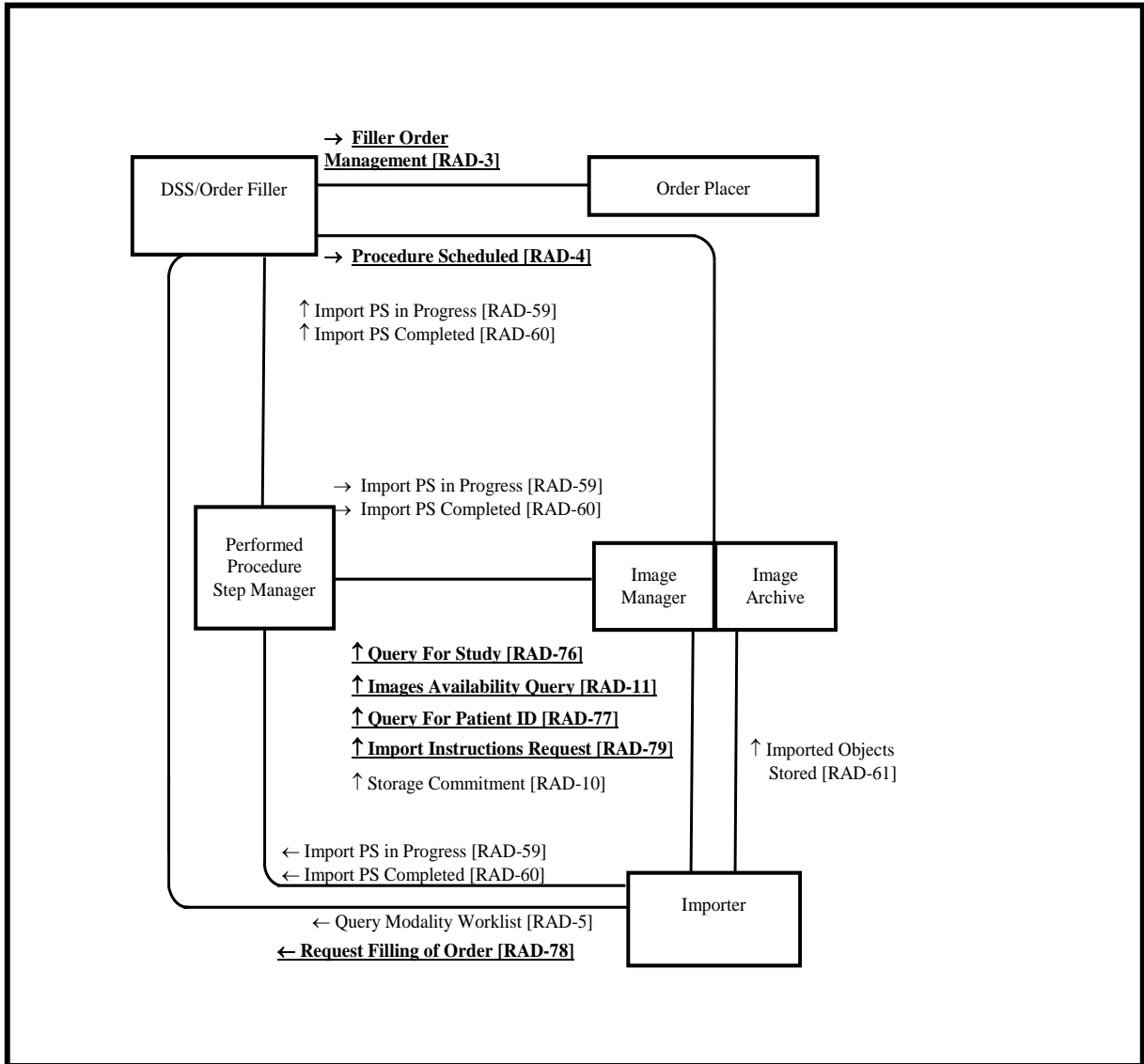

325

**Figure 21.1-1: Import Reconciliation Workflow Diagram**

330

Table 21.1-1 lists the transactions for each actor directly involved in the Import Reconciliation Workflow Integration Profile. In order to claim support of this Integration Profile, Import Reconciliation Actors present in the Scheduled Workflow Profile must also support Scheduled Workflow and perform the required transactions (labeled “R”). Transactions labeled “O” are optional. A complete list of options defined by this Integration Profile that implementations may choose to support is listed in Section 21.2.

335

**Table 21.1-1: Import Reconciliation Workflow Integration Profile - Actors and Transactions**

<b>Actors</b>	<b>Transactions</b>	<b>Optionality</b>	<b>TF Reference</b>
<b>Order Placer</b>	<b>Filler Order Management [RAD-3]</b>	<b><u>R</u></b>	<b><u>RAD TF-2: 4.3</u></b>
Department System Scheduler/ Order Filler	Import Procedure Step In Progress [RAD-59]	R	RAD TF-3: 4.59
	Import Procedure Step Completed [RAD-60]	R	RAD TF-3: 4.60
	<b>Filler Order Management [RAD-3]</b>	<b><u>R</u></b>	<b><u>RAD TF-2: 4.3</u></b>
	<b>Procedure Scheduled [RAD-4]</b>	<b><u>R</u></b>	<b><u>RAD TF-2: 4.4</u></b>
	<b>Query Modality Worklist [RAD-5]</b>	<b><u>R</u></b>	<b><u>RAD TF-2: 4.5</u></b>
	<b>Request Filling of Order [RAD-78]</b>	<b><u>O</u></b>	<b><u>RAD TF-3: 4.78</u></b>
<b>Patient Demographics Supplier</b>	<b>Patient Demographics Query [IFI-21]</b>	<b><u>R</u></b>	<b><u>IFI TF-2a: 3.21</u></b>
Importer	Query Modality Worklist [RAD-5] ( <b>Note 1</b> )	<b><u>OR</u></b>	<b><u>RAD TF-2: 4.5</u></b>
	<b>Patient Demographics Query [IFI-21] (<b>Note 1</b>)</b>	<b><u>O</u></b>	<b><u>IFI TF-2a: 3.21</u></b>
	<b>Images Availability Query [RAD-11]</b>	<b><u>R</u></b>	<b><u>RAD TF-2: 4.11</u></b>
	<b>Query For Study [RAD-76]</b>	<b><u>R</u></b>	<b><u>RAD TF-3: 4.76</u></b>
	<b>Query For Patient ID [RAD-77]</b>	<b><u>R</u></b>	<b><u>RAD TF-3: 4.77</u></b>
	<b>Request Filling of Order [RAD-78]</b>	<b><u>O</u></b>	<b><u>RAD TF-3: 4.78</u></b>
	<b>Import Instructions Request [RAD-79]</b>	<b><u>O</u></b>	<b><u>RAD TF-3: 4.79</u></b>
	Import Procedure Step In Progress [RAD-59]	R	RAD TF-3: 4.59
	Import Procedure Step Completed [RAD-60]	R	RAD TF-3: 4.60
	Imported Objects Stored [RAD-61]	R	RAD TF-3: 4.61
Storage Commitment [RAD-10]	R	<b><u>RAD TF-2: 4.10</u></b>	
Image Manager/ Image Archive	Import Procedure Step In Progress [RAD-59]	R	RAD TF-3: 4.59
	Import Procedure Step Completed [RAD-60]	R	RAD TF-3: 4.60
	Imported Objects Stored [RAD-61]	R	RAD TF-3: 4.61
	Storage Commitment [RAD-10]	R	<b><u>RAD TF-2: 4.10</u></b>
	<b>Procedure Scheduled [RAD-4]</b>	<b><u>R</u></b>	<b><u>RAD TF-2: 4.4</u></b>
	<b>Images Availability Query [RAD-11]</b>	<b><u>R</u></b>	<b><u>RAD TF-2: 4.11</u></b>
	<b>Query For Study [RAD-76]</b>	<b><u>R</u></b>	<b><u>RAD TF-3: 4.76</u></b>
	<b>Query For Patient ID [RAD-77]</b>	<b><u>R</u></b>	<b><u>RAD TF-3: 4.77</u></b>
<b>Import Instructions Request [RAD-79]</b>	<b><u>O</u></b>	<b><u>RAD TF-3: 4.79</u></b>	
Performed Procedure Step Manager	Import Procedure Step In Progress [RAD-59]	R	RAD TF-3: 4.59
	Import Procedure Step Completed [RAD-60]	R	RAD TF-3: 4.60

**Note 1: The Importer shall support at least one of the Query Modality Worklist or Patient Demographics Query transactions.**

Refer to Table 2-1 for other profiles that may be pre-requisites for this profile

340 **21.1.1 Actor Descriptions and Actor Profile Requirements**

**For simple definitions of the actors in this profile, refer to RAD TF-1: 2.3.**

**Any actor claiming to support the Import Reconciliation Workflow Profile shall support Scheduled Import as defined in RAD TF-1: 21.3.1.1. For the process flow for this refer to RAD TF-1: 21.3.1.2.**

345 **The following actors have additional specific details:**

**21.1.1.1 Importer Actor**

350 **The Importer needs to obtain local patient information in order to reconcile the imported objects. It can obtain local patient information using Query Modality Worklist [RAD-5], Query for Study [RAD-76], PIX Query [ITI-9], PDQ Query [ITI-21], or Query for Patient ID [RAD-77]. All of these transactions could return multiple possible matches so the Importer needs to be capable of seeking resolution of such patient conflicts.**

355 **Import Reconciliation Workflow does not specify a particular resolution mechanism because an Importer could be deployed in several different ways. For example, it could be implemented as a workstation for import that requires user interaction, such as for inserting media to be imported, and which thus implements conflict resolution support through a user interface for the operator. However, an Importer could also be implemented as an automated product requiring no user interaction, such as part of some automated pre-fetch application, which implements conflict resolution through some administrator managed exception handling list.**

360 **21.2 Import Reconciliation Workflow Integration Profile Options**

Options that may be selected for this Integration Profile are listed in the Table 21.2-1 along with the actors to which they apply. Dependencies between options, when applicable, are specified in notes.

**Table 21.2-1: Import Reconciliation Workflow - Actors and Options**

<b><u>Actor</u></b>	<b><u>Option</u></b>	<b><u>TF Reference</u></b>
<b><u>Patient Demographics Supplier</u></b>	<b><u>No options defined</u></b>	<b><u>=</u></b>
<b><u>Order Placer</u></b>	<b><u>No options defined</u></b>	<b><u>=</u></b>
Department System Scheduler/ Order Filler	<b><u>Automated Order Placement and Scheduling</u></b>	<b><u>RAD TF-1: 21.2.3</u></b>
	<b><u>Import Instruction Handling</u></b>	<b><u>RAD TF-1: 21.2.4</u></b>
	<b><u>Billing and Material Management</u></b>	<b><u>RAD TF-1: 21.2.5</u></b>
Importer	<b><u>Scheduled Import (note 1)</u></b>	<b><u>RAD TF-1: 21.2.1</u></b>
	<b><u>Unscheduled Import (note 1)</u></b>	<b><u>RAD TF-1: 21.2.2</u></b>

<u>Actor</u>	<u>Option</u>	<u>TF Reference</u>
	<u>Automated Order Placement and Scheduling</u>	<u>RAD TF-1: 21.2.3</u>
	<u>Import Instruction Handling</u>	<u>RAD TF-1: 21.2.4</u>
	Billing and Material Management	<del>RAD TF-3: 4.60</del> <u>RAD TF-1: 21.2.5</u>
Image Manager/ Image Archive	<u>Import Instruction Handling</u>	<u>RAD TF-1: 21.2.4</u>
Performed Procedure Step Manager	No Option defined	-

365 **Note 1: ~~The Importer shall support at least one of the Scheduled Import, or Unscheduled Import options.~~**

The Importer and Image Manager/ Image Archive will likely support a variety of DICOM SOP Classes. It is expected that this level of optionality will be documented in the DICOM Conformance Statement.

### 21.2.1 Scheduled Import Option

370 **This option has been retired. The Scheduled Import method of import reconciliation is now a default behavior that shall be supported by actors supporting the Import Reconciliation Workflow Profile.**

375 **~~Importers claiming the Scheduled Import Option are required to support the Query Modality Worklist transaction (See RAD TF-2: 4.5) to obtain import worklists and use the patient and procedure information provided to reconcile the imported data.~~**

~~For further details of this option, refer to RAD TF-3: 4.59.4.1.2.3.1.~~

### 21.2.2 Unscheduled Import Option

380 **This option has been retired. The Unscheduled Import method of import reconciliation is now a default behavior that shall be supported by actors supporting the Import Reconciliation Workflow Profile.**

~~Importers claiming the Unscheduled Import Option are required to support the Patient Demographics Query transaction (See ITI TF-2: 4.21) to obtain patient demographics for reconciling the imported data.~~

~~For further details of this option, refer to RAD TF-3 4.59.4.1.2.3.2.~~

385 **~~Note that the identifiers provided by the ITI Patient Demographic Supplier Actor are expected to be consistent with those that would be obtained using SWF transactions. This is necessary to ensure the synchronization of the Patient Demographics from both sources.~~**

### 21.2.3 Automated Order Placement and Scheduling Option.

390 **The Automated Order Placement and Scheduling Option allows the institution to have the import task scheduled on the Importer rather than requiring manual scheduling of it on the DSS/Order Filler.**



395 **Importers and Image Manager/Archives claiming the Automated Order Placement and Scheduling Option rely on the same transactions and process flow used by the Unscheduled Import method of import to determine whether or not the data has already been imported, and for obtaining the information for reconciling the data if it does need to be imported.**

**Actors claiming the Automated Order Placement and Scheduling Option shall also support the transactions and their sequencing specified in 21.3.1.5 Automated Order Placement and Scheduling Process Flow.**

400 **The Department System Scheduler/Order Filler supporting the Automated Order Placement and Scheduling Option shall support the following:**

- **Request Filling of Order [RAD-78], RAD TF-3: 4.78**
- **Option specific behavior for Procedure Scheduled [RAD-4], RAD TF-2: 4.4.4.1.2.1.5.1.1 and 4.4.4.1.2.2.8.1.1.**

405 **The Importer supporting the Automated Order Placement and Scheduling Option shall support the following:**

- **Request Filling of Order [RAD-78], RAD TF-3: 4.78**

**For further details of the relationship between Scheduled and Performed Procedure Steps for this option, refer to RAD TF-3: 4.59.4.1.2.3.3.**

#### **21.2.4 Import Instruction Handling Option**

410 **The Import Instruction Handling Option allows an institution to set instructions to be used for imported data and have these acted upon by the Image Manager/Archive receiving this data.**

**The Department System Scheduler/Order Filler supporting the Import Instruction Handling Option shall support the following:**

- 415
- **User selectable inclusion of Import Instructions in Procedure Scheduled [RAD-4], RAD TF-2: 4.4.4.1.2.1.5.1.2 and 4.4.4.1.2.2.8.1.2.**
  - **User selectable inclusion of Import Instructions in Worklist [RAD-5], RAD TF-2: 4.5.4.2.2.1.1.**

420 **An Importer supporting the Import Instruction Handling Option shall support the following:**

- **Configurable Institution Name Mapping for Objects Received Over the Network (RAD TF-3: K.2.1.1) so that the Institution Name attribute and the Institution Code Sequence can be conveyed in the Imported Objects Stored [RAD-61] transaction between the Importer and Image Manager/Archive (RAD TF-3: K.2.1).**
  - **Configurable Import Instruction Code Mapping for Objects Received Over the Network (RAD TF-3: K.2.2.1)**
- 425

- **Ability to convey the Import Instructions directly to the Image Manager/Archive using the Import Instructions Request [RAD-79].**

430 **An Image Manager/Archive supporting the Import Instruction Handling Option shall support the following:**

- **Ability to receive the Import Instructions from the Department System Scheduler/Order Filler using the Procedure Scheduled Request [RAD-4].**
- **Ability to receive the Import Instructions directly from the Importer using the Import Instructions Request [RAD-79].**

435 • **Taking specific actions based on the provided Import Instructions (RAD TF-3: K.3.1).**

### **21.2.5 Billing and Material Management Option**

**The Billing and Material Management Option allows an institution to set material management codes during the import process and use them for calculation of charges.**

440 **The Department System Scheduler/Order Filler supporting the Billing and Material Management Option shall support the following:**

- **Ability to use the billing codes and/or material usage information provided by the Importer in the Import Procedure Step Completed/Discontinued [RAD-60], RAD TF-3: 4.60.4.1.3.2).**

445 **An Importer supporting the Billing and Material Management Option shall support the following:**

- **Ability to transmit material management codes to the DSS/Order Filler using the Import Procedure Step Completed/Discontinued [RAD-60], RAD TF-3: 4.60.4.1.2.3).**

## **450 21.3 Integration Workflow Process Flow**

This section describes the workflow related to importing DICOM data or importing hardcopy created external to the Enterprise. Import Reconciliation Workflow uses many transactions from Scheduled Workflow (See RAD TF-1: 3.3). In most cases there are no changes in these transactions. See Appendix C for an overview of the information exchange between the  
455 Department System Scheduler/Order Filler and Image Manager.

Once the desired information has been imported into the local Enterprise it is up to the local institution to determine the retention policies for physical media associated with the import (e.g., films, CDs, DVDs) and the imported data itself.

### **21.3.1 Import Process Flow**

460 This section describes ~~the~~ typical process flows for managed importation. This profile only applies to data from patients that have been registered and assumes that the patient demographics

information is known and available to the local system and user. If the Patient is not registered, the data is imported and needs to be reconciled by other mechanisms such as PIR.

### 21.3.1.1 Use Cases

465 The primary use cases for importing radiology information are:

1. External Acquisition or Read: An institution has referred the patient to an external facility for acquisition, or for reading. The institution receives the acquired study on media **or via network exchange** from the external facility and imports it to the local archive.
- 470 2. External Priors: The institution receives ~~media containing~~ prior images and/or reports for a current patient **on media or via network exchange**. The data is imported to the local archive and associated with the patient’s record so they can be referred to as priors during the reading of the current study.
3. Patient Referral: The institution receives ~~media containing~~ a patient’s radiological history associated with a referral or patient transfer, **on media or via network exchange**.  
475 The data is imported to the local archive and associated with the patient’s record.

The importation may be managed ~~in two~~ using **multiple** different ~~ways~~**methods**:

1. Scheduled Import: The institution schedules the import task **on the RIS, which provides** ~~an~~ importation worklist **which provides with** the local demographics and local procedure information.
- 480 2. Unscheduled Import: The institution does not electronically schedule the import task and instead relies on the Importer to obtain **the** local **patient identifier**~~demographics from a Demographics Supplier~~.
3. **Automated Order Placement and Scheduling: The institution schedules the import task on the Importer rather than requiring manual scheduling on the DSS/Order Filler. The DSS/Order Filler then must place the order with the Order Placer in response to the request for filling an order that it receives from the Importer.**  
485

In ~~either any of these~~ cases it is a prerequisite that the patient has been registered so that locally correct demographic information for the patients is available. Importation of “locally unknown” patients followed by Patient Information Reconciliation is not covered by this Integration Profile.

490 Importation could be performed piecewise on a physician’s workstation, or batched at a central location.

The data may arrive at the institution by a variety of transport mechanisms including hardcopy (films, prints), media (CDs, DVDs) or simple network transfer. This profile does not dictate a particular transport mechanism.

495 For any import, there may exist information in addition to the media, which will be taken into account by the importing enterprise but its usage is not specified by IHE. This information may be available electronically, written or orally. Main examples for such information are:

- Administrative information like checklists, importation rules, workflow codes or billing items.
- 500 • Clinical information like lab reports, discharge summaries, ECGs, potentially as PDI web data.

Note that the person **or system** importing the Evidence Objects or Hardcopy can be assumed to have the most comprehensive and complete information available for the importing task. In case of exceptions, the import may need to be aborted (see RAD TF-3: 4.60.4.1.2.2 for Exception Management).

**There can be a wide variation in deployment scenarios and use cases to be met for an Importer when reconciling the imported data:**

- **The data may have already been fully or partially imported.**
- 510 • **The infrastructure may or may not support a PIX Patient Identifier Cross-reference Manager (PIX Manager) or PDO Patient Demographics Supplier.**
- **Even if there is a PIX Manager, the data to be imported may have a patient identifier assigning authority which is unknown to the PIX Manager, thus requiring support for a demographics based lookup to determine the local identifier.**
- 515 • **The Importer could be acting in an automated manner, so this profile does not mandate any user interaction based features.**

**The Unscheduled Import method provides a robust means for an Importer to reconcile the patient information even though the institution has not scheduled a task for importing the data. The Importer determines whether any import task is actually required, and if so it uses information from any prior import of the study. If there was no prior import the Importer obtains the local patient identifier and possibly local demographics by querying a Patient Identifier Cross-reference Manager, a Patient Demographics Supplier, or the destination Image Manager/Archive.**

After the importation is done and the imported evidence objects are available through the Image Manager/ Image Archive (which ~~is~~ may be indicated by an Instance Availability Notification), the enterprise may schedule subsequent steps like reading or reporting.

**The following process flows shall be supported by actors supporting the Import Reconciliation Workflow Profile:**

- **Imported Objects Storage Process Flow, RAD TF-1: 21.3.1.2**
- **Scheduled Import Process Flow, RAD TF-1: 21.3.1.3**
- 530 • **Unscheduled Import Process Flow, RAD TF-1: 21.3.1.4**

**The following process flows are optional for actors supporting the Import Reconciliation Workflow Profile:**

- **Automated Order Placement and Scheduling Process Flow, RAD TF-1: 21.3.1.5**

- **Import Instruction Handling, RAD TF-1: 21.3.1.6**

535 **21.3.1.2 Imported Objects Storage Process Flow**

**The patient and procedure reconciliation for the DICOM objects to be imported can be done using the Scheduled, Unscheduled, or Automated Order Placement and Scheduling Import method. Regardless of which of these methods is used, the resultant DICOM objects are then stored in the Image Manager/Archive using the following Imported Objects Storage process flow.**

540

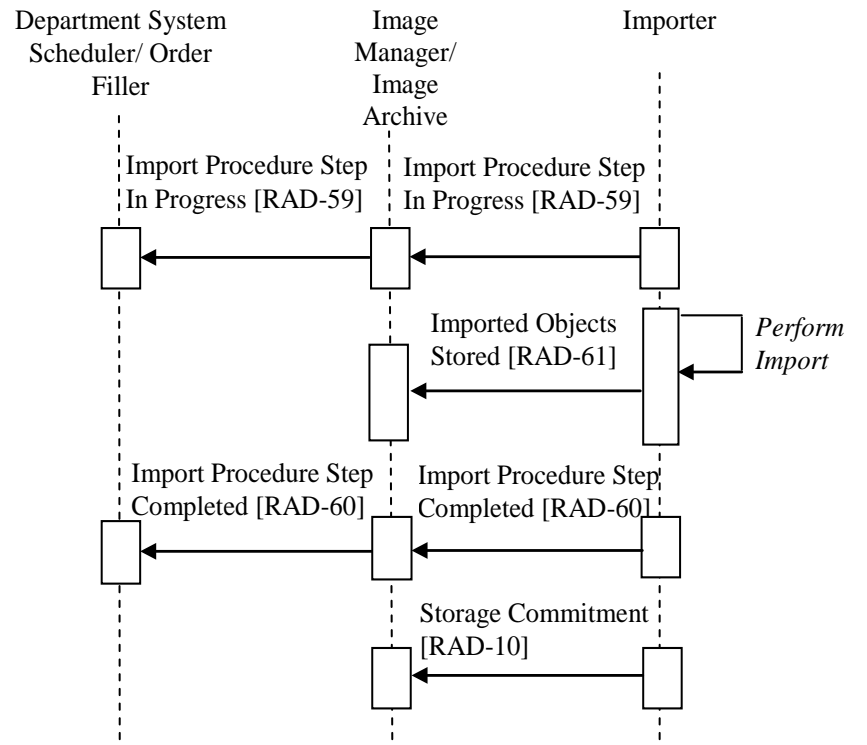

**Figure 21.3.1-1: Imported Objects Storage Process Flow**

545 **21.3.1.23 Scheduled Import Process Flow**

An enterprise internally schedules an import, e.g., associated with an external acquisition or read, **using a manual process to create and fill the order on the DSS/Order Filler**. There may be other scheduling items, which are not within the scope of the Technical Framework, but will be taken into account by the Enterprise:

550

- For external referrals, patient and order information needs to be conveyed to the external Enterprise.

- Clinical information may be received in addition to the DICOM information, e.g., electronic referrals, Lab Reports, Clinical Summaries, or PDI web information.
- 555 • The importation of data is typically a scheduled event separate from how the data is used (images to be reported, historical data to be used in-conjunction with a current procedure, etc.).
- The importation scheduling information may include instructions, e.g., which studies, series or images are to be imported.

The following steps can be identified in the scheduled process flow:

- 560 • Using Scheduled Workflow, the relevant study data to be imported is available in the scheduled procedure step. Note that the Patient Registration and Procedure Ordering all use the Scheduled Workflow Profile (See Sections 3.3.1, 3.3.2, 3.3.3).
- 565 • Depending on the type of media to be imported **or data received over the network**, the procedure step can be scheduled to the appropriate Importing device (e.g., Film Scanner, PDI Workstation, **an Importer integrated with an Image Manager/Archive that is receiving data from another Image Manager/Archive, etc.**).
- 570 • ~~The Importer~~**The SCHEDULED IMPORT Option is used to** imports the evidence objects and reconciles the patient and procedure data (e.g., to change the recorded Patient ID to the local Patient ID) using the Modality Worklist Query. The resultant DICOM objects are stored in the **Image Manager/Archive**.
- Errors and exceptions during import are handled by using Exception Management described in RAD TF-3: 4.60.4.1.2.2.
- Subsequent steps may be
  - performed, such as implicit post-processing (see Section 3.3.5);
  - 575 • scheduled for a Post-Processing or Reporting Workflow, probably involving the availability notification option.

This process flow requires that the Patient be registered and that procedure step(s) be scheduled for the importation. Associated Patient Registration Scheduling, and subsequent Availability or Notification transactions are part of the Scheduled Workflow (See Section 3.3). The following  
580 sequence of steps describes the typical process flow for the ~~s~~**S**cheduled ~~i~~**I**mport of patient data.

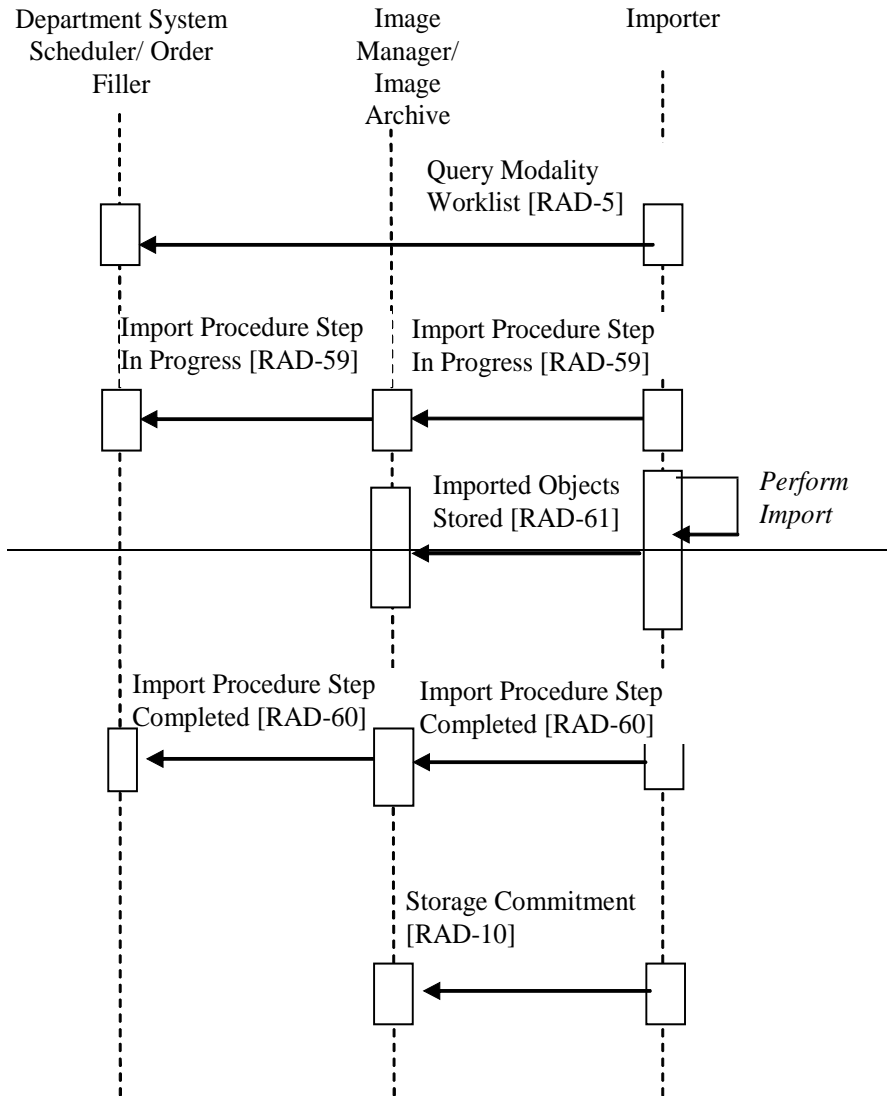

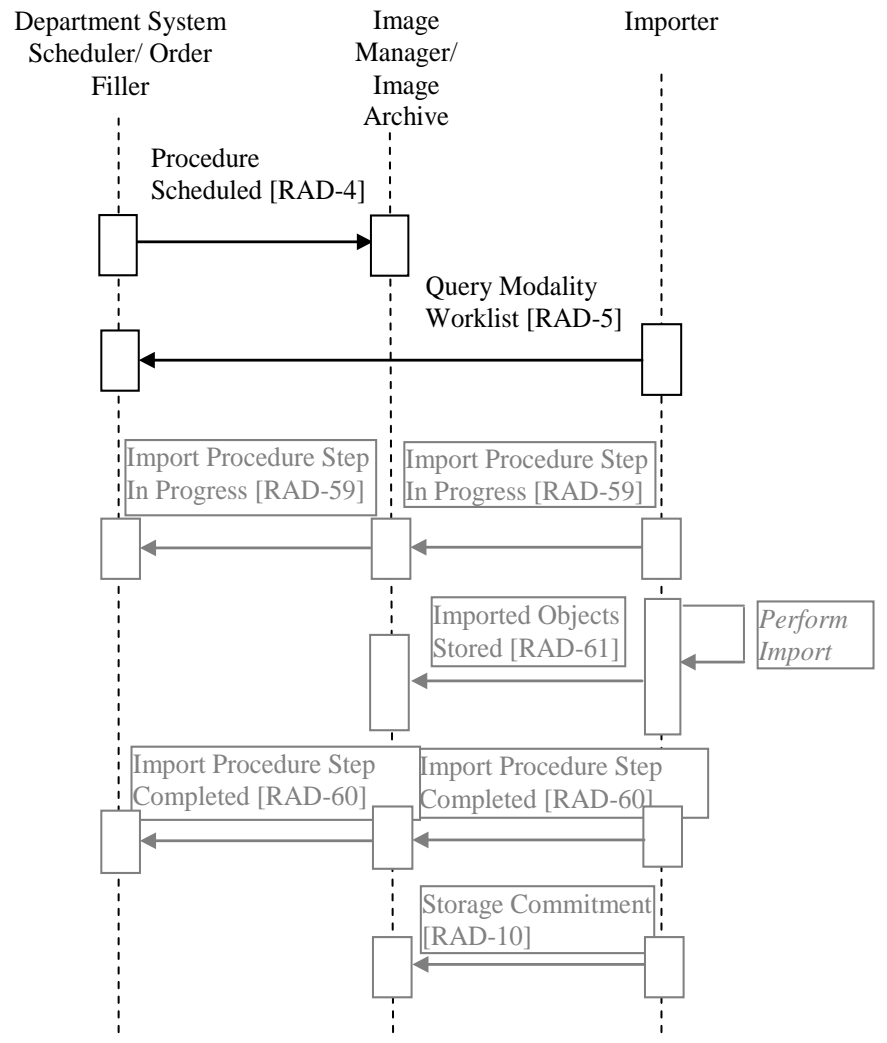

**Figure 21.3.1-42: Scheduled Import Reconciliation Workflow Process Flow**

585

**21.3.1.23.1 Scheduled Import Data Reconciliation**

Importation requires that some of the Patient/Procedure information be treated differently than prescribed in Scheduled Workflow.

590 The Study UID provided by the Modality Worklist shall be ignored and the reconciliation rules shall be followed. As part of the import process, the Importer reconciles the patient data as needed (e.g., to change the recorded Patient ID to the local Patient ID). See RAD TF-2: Appendix A.5 for a full list of the reconciliation requirements. The original DICOM object identifiers must be maintained in the imported DICOM Composite Objects. The policies of the importing enterprise will determine



- 595
- if demographics from the Import Data can be used (e.g., Birth Date, Patient Sex).
  - whether or how enterprise-specific codes in the imported data are coerced or ignored.

#### 21.3.1.34 Unscheduled Import Process Flow

600 An enterprise has received evidence objects for import that are not part of ~~a an order or~~ scheduled procedure in one of its information systems, e.g., relevant priors prior to a consultation. There is no scheduled procedure to trigger the importation. The actual task of importation may be a batched process that does not schedule individual importations.

- 605
- Aside from the physical media (e.g., films, CDs), there may be clinical information in addition to the DICOM data in electronic, written or oral format, such as referral letters. The incorporation of this information into the Enterprise is out of scope for the Import Reconciliation Workflow.

The following steps can be identified in this process flow:

- 610
- ~~The User does the The import is done at an appropriate device (e.g., a film scanner is used to digitize films, a workstation with PDI capabilities is used to import PDI media, a PACS is used to import objects received over the network from another PACS, etc.).~~
  - ~~The UNSCHEDULED IMPORT Option is used to retrieve the Patient Demographics information, import the Evidence Objects and to reconcile the patient data (e.g., to change the recorded Patient ID to the local Patient ID) using the Patient Demographics Query. The resultant DICOM objects are stored in the PACS.~~
  - 615 • The Importer queries the Image Manager/Archive using the Query For Study [RAD-76] transaction to determine whether or not the study already exists. If it does then the Importer queries the Image Manager/Archive to determine whether or not it already has all the objects being imported using the Images Availability Query [RAD-11] transaction.
  - 620 • If the study already exists in the Image Manager/Archive but it does not already have some or all of the objects to be imported, then Importer uses the patient demographics and study information obtained by the initial query of the Image Manager/Archive to reconcile the patient and procedure data (e.g., to change the recorded Patient ID to the local Patient ID). The Importer stores the resultant DICOM objects in the Image Manager/Archive.
  - 625 • If the study does not already exist in the Image Manager/Archive then Importer uses the PIX Query [ITI-9] to retrieve the local Patient Identifier in order to reconcile the patient data. If there is a PIX Manager in the environment then the Importer shall always perform the PIX Query [ITI-9] first, as this is the only query that can provide a definitive matching local Patient Identifier.
  - 630 • If the Importer cannot determine the local Patient Identifier using a PIX Query [ITI-9] (e.g., because there is no PIX Manager, the recorded Patient ID assigning
-

- 635 authority is unknown to the PIX Manager, etc.), it then uses the Patient Demographics Query [ITI-21] if there is a Patient Demographics Supplier in the environment.
- Finally, if there is no Patient Demographics Supplier then the Importer uses Query For Patient ID [RAD-77] to retrieve the local Patient Identifier and demographics from the Image Manager/Archive in order to reconcile the patient data.
  - 640 • The Importer reconciles the patient data in the DICOM objects (e.g., changes the recorded Patient ID to the local Patient ID) and stores the resultant objects to the PACS using the Imported Objects Storage Process Flow.
  - Errors and exceptions during import are handled by using Exception Management described in RAD TF-3: 4.60.1.2.2.
  - 645 • The Evidence Objects are available from the PACS and may be used in subsequent scheduled or unscheduled steps, or at a later time.

~~This process flow Import Reconciliation Workflow~~ requires that the Patient be registered prior to import. Associated Patient Registration, and subsequent Availability or Notification transactions are part of the Scheduled Workflow (See Section 3.3). The following sequence of steps describes the typical process flow for the ~~u~~Unscheduled ~~i~~Import of patient data. Note that this process flow shows the Importer performing all three of the PIX Query [ITI-9], Patient Demographic Query [ITI-21], and Query for Patient ID [RAD-77] transactions whereas in an actual environment the number of transactions used would depend on whether or not a PIX Manager and/or Demographic Supplier are actually present. If a Demographic Supplier is supported in the environment then Query for Patient ID [RAD-77] would not be used.

655 All of these transactions could return multiple possible patient matches. The Importer shall be capable of seeking resolution of such patient conflicts, through a user interface, an exception handling list, or some other mechanism. It shall be capable of communicating the issue and enabling resolution.

660 Note that the identifiers provided by the Patient Identifier Cross-reference Manager, Patient Demographic Supplier, or Image Manager/Archive are expected to be consistent with those that would be obtained using SWF transactions. This is necessary to ensure the synchronization of the Patient Identifier and demographics from all sources.

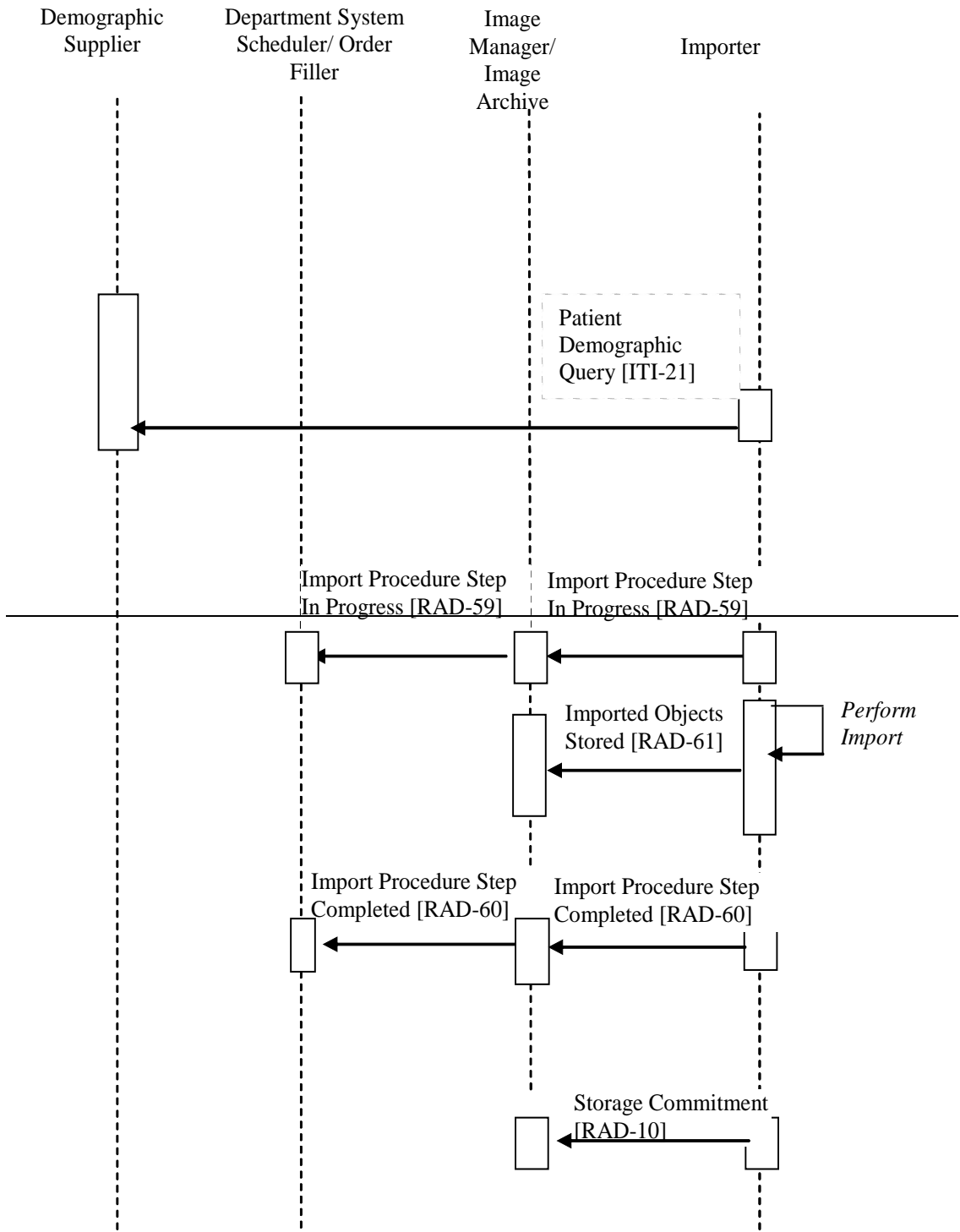

665

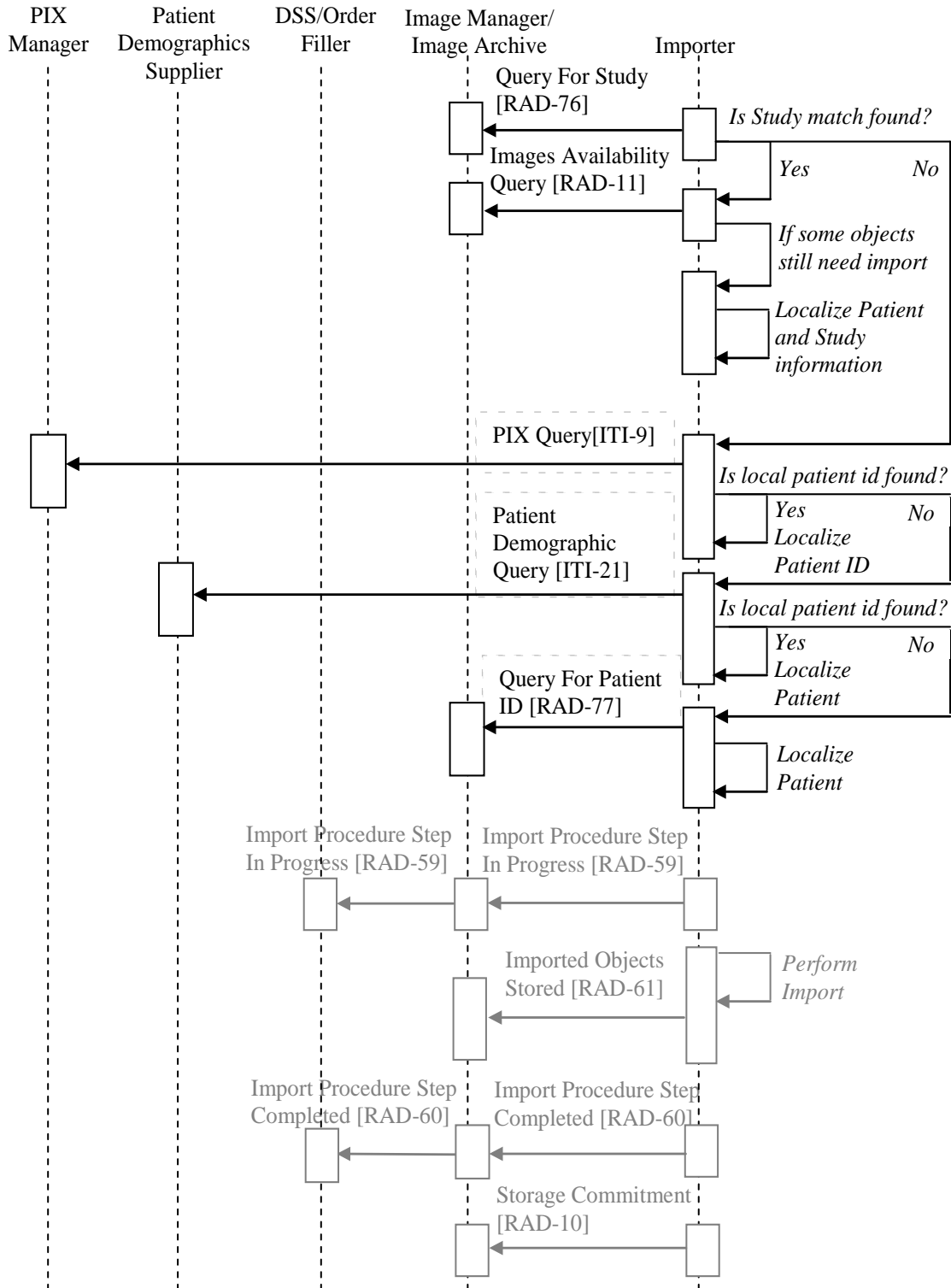

Figure 21.3.1-23.: Unscheduled Import Reconciliation Workflow Process Flow

670 **An Importer shall support both the Scheduled Import and Unscheduled Import methods for Import Reconciliation Workflow. A particular process flow for combining such support is not mandated because several different approaches are plausible. For example, if an Importer is implemented such that it requires user interaction then it would make sense that it perform the Query Modality Worklist [RAD-5] first, and only performs the**  
675 **Unscheduled Import method transactions if a corresponding match is not found. However, if an Importer is implemented to support automated functionality, such as part of some automated pre-fetch application, then it makes sense for it to perform the Unscheduled Import method transactions first to resolve the local patient identifier, before querying to see if there is a corresponding scheduled procedure step using Query Modality Worklist [RAD-5] of the Scheduled Import method.**

#### 680 **21.3.1.34.1 Unscheduled Import Data Reconciliation**

**Importation requires that some of the Patient/Procedure information be treated differently than prescribed in Scheduled Workflow.**

As part of the import process, the Importer reconciles the patient data as needed (e.g., to change the recorded Patient ID to the local Patient ID). **See RAD TF-2: Appendix A.5 for a full list of**  
685 **the reconciliation requirements.** The original DICOM object identifiers ~~shall must~~ be maintained in the imported DICOM Composite Objects ~~in order to maintain the relationship of the Images within the Study (See RAD TF-2: Appendix A.5).~~. The policies of the importing enterprise will determine

- 690 • ~~whether if~~ demographics from the **Import Data import data** can be used (e.g., Birth Date, Patient Sex).
- whether or how enterprise-specific codes in the imported data are coerced or ignored.

#### **21.3.1.5 Automated Order Placement and Scheduling Process Flow**

695 **An enterprise internally schedules an import, e.g., associated with an external acquisition or read, creating and filling the order on the Importer rather than on the DSS/Order Filler. There may be other scheduling items, which are not within the scope of the Technical Framework, but will be taken into account by the Enterprise:**

- **For external referrals, patient and order information needs to be conveyed to the external Enterprise.**
- 700 • **Clinical information may be received in addition to the DICOM information, e.g., electronic referrals, Lab Reports, Clinical Summaries, or PDI web information.**

**The following steps can be identified in the process flow:**

- 705 • **The import is done at an appropriate device (e.g., a film scanner is used to digitize films, a workstation with PDI capabilities is used to import PDI media, an Importer on a workstation or PACS is used to import objects received over the network from another PACS, etc.).**

- **The Importer first reconciles the patient information using the same transactions and process flow defined in the Unscheduled Import process flow.**
- 710 • **If the Study does not already exist in the Image Manager, the Importer then uses the Automated Order Placement and Scheduling Option to schedule the order and create the procedure step for import of the objects. The Importer uses the Request Filling of Order [RAD-78] transaction to create the procedure step on the Department System Scheduler/Order Filler. The Department System Scheduler/Order Filler then places the order with the Order Placer using the Filler Order Management [RAD-3] transaction. The DSS/Order Filler then returns the**
- 715 **details of the placed and filled order to the Importer in the response to the Request Filling of Order [RAD-78] transaction. Local procedure data for the new order could be retrieved by the Importer using the ITI Domain Sharing Value Sets Profile or some other mechanism.**
- 720 • **The Importer uses the resulting procedure information, returned in the Request Filling of Order [RAD-78] response from the DSS/Order Filler, to reconcile the procedure data in the DICOM objects. The Importer stores the resultant DICOM objects in the Image Manager.**
- **Errors and exceptions during import are handled by using Exception Management described in RAD TF-3: 4.60.4.1.2.2.**
- 725 • **Subsequent steps may be:**
  - **performed, such as implicit post-processing (see Section 3.3.5);**
  - **scheduled for a Post-Processing or Reporting Workflow, probably involving the availability notification option.**

730 **This process flow requires that the Patient be registered prior to import. The following sequence of steps describes the typical process flow for the automated scheduled import of patient data.**

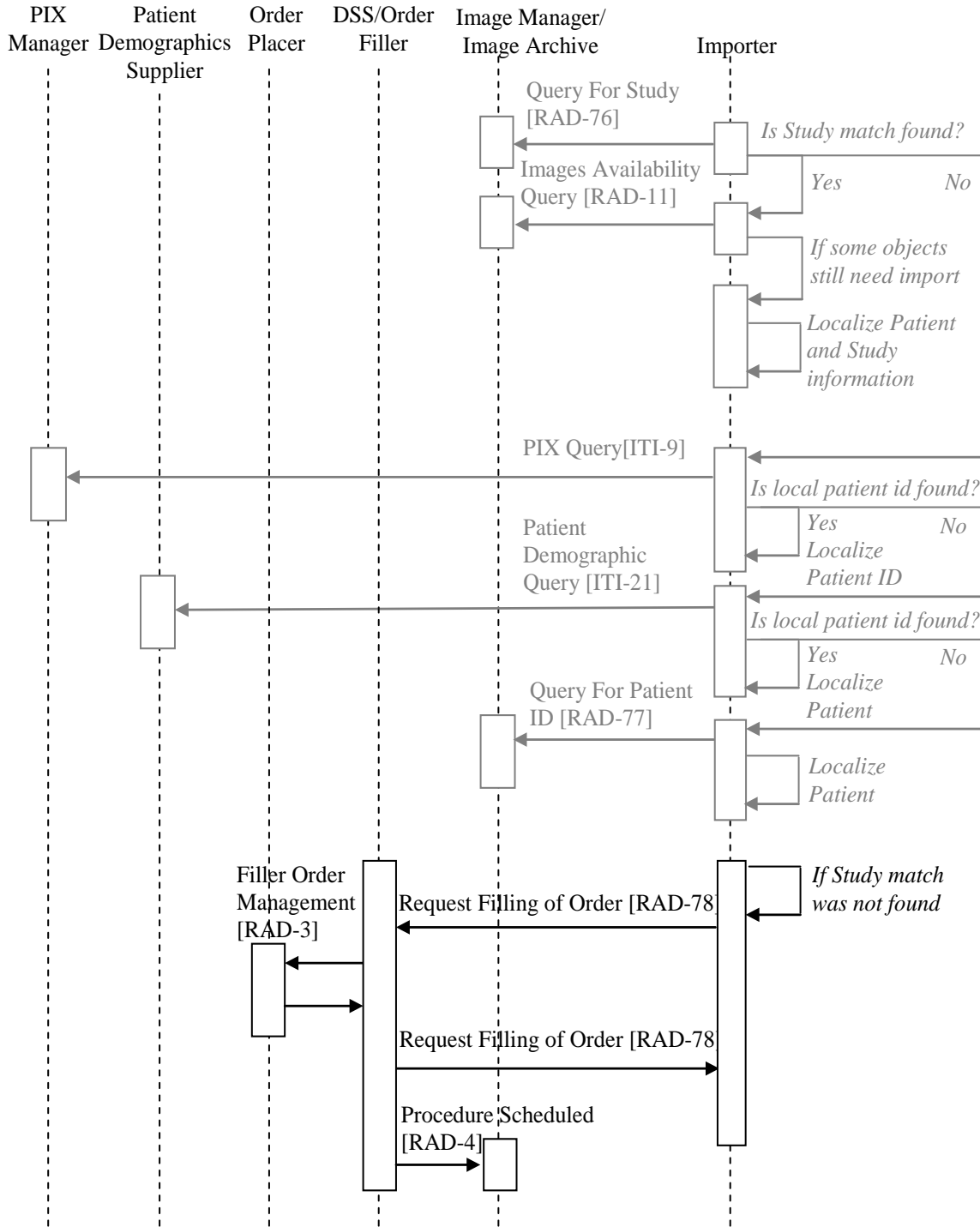

**Figure 21.3.1-4: Automated Order Placement and Scheduling – Filling of Order – Import Reconciliation Workflow Process Flow**

735

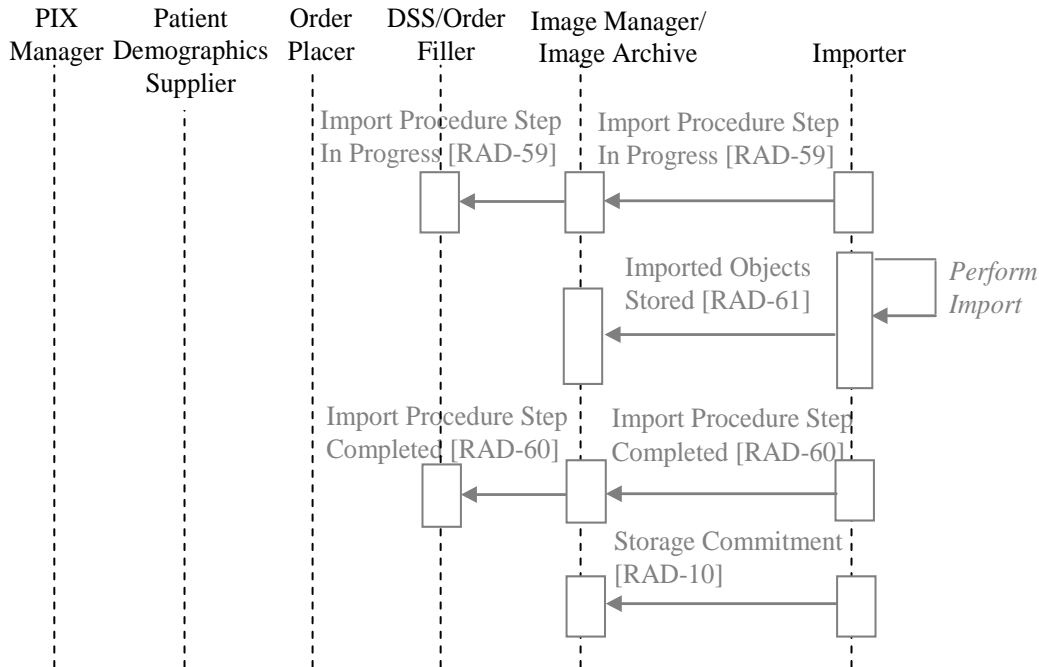

**Figure 21.3.1-5: Automated Order Placement and Scheduling - Imported Objects Storage – Import Reconciliation Workflow Process Flow**

740

**21.3.1.5.1 Automated Order Placement and Scheduling Data Reconciliation**

**Importation requires that some of the Patient/Procedure information be treated differently than prescribed in Scheduled Workflow.**

745

**As part of the import process, the Importer reconciles the patient data as needed (e.g., to change the recorded Patient ID to the local Patient ID). See RAD TF-2: Appendix A.5 for a full list of the reconciliation requirements. The original DICOM object identifiers must be maintained in the imported DICOM Composite Objects. The policies of the importing enterprise will determine**

750

- **if demographics from the import data can be used (e.g., Birth Date, Patient Sex).**
- **whether or how enterprise-specific codes in the imported data are coerced or ignored. Note that it is recommended that the following Profiles be utilized to enable the Importer to obtain sets of values to be used in the automatically created orders and procedure steps: the ITI Sharing Value Sets (SVS) Profile for procedure codes, ITI Healthcare Provider Directory (HPD) Profile for ordering location information, and HPD or ITI Personnel White Pages (PWP) Provider for the ordering provider.**

755



### **21.3.1.6 Import Instruction Handling Process Flow**

760 **The Import Instruction Handling Option allows an institution to set instructions to be used for imported data and have these acted upon by the Image Manager/Archive receiving this data. The Import Instruction Handling Option defines certain behavior that shall be supported by the DSS/Order Filler, Importer, and Image Manager/Archive when it is combined with the default Scheduled or Unscheduled Import Reconciliation Workflow behavior, or Automated Order Placement and Scheduling Option.**

**For the Import Instruction Handling Option there are three ways the Image Manager/Archive can receive the Import Instructions:**

- 765 • **The operator of the DSS/Order Filler sets the Import Instructions and they are sent to the Image Manager/Archive in a Procedure Scheduled [RAD-4] or Procedure Update [RAD-13] transaction (see RAD TF-1: 21.3.1-1).**
- 770 • **The Importer supports the Automated Order Placement and Scheduling Option and sends the Import Instructions to the DSS/Order Filler using the Request Filling of Order [RAD-78] transaction. The DSS/Order Filler then sends the Import Instructions to the Image Manager/Archive in a Procedure Scheduled [RAD-4] transaction (see RAD TF-1: 21.3.1-4).**
- 775 • **The Importer sends the Import Instructions directly to the Image Manager/Archive using the Import Instructions Request [RAD-79] transaction when handling Unscheduled Import.**

780 **It is only in the final case, when handling the Unscheduled Import method, that new process flow is added by the Import Instruction Handling Option. The Importer shall use the Import Instructions Request [RAD-79] transaction to convey the Import Instructions directly to the Image Manager, which shall support using them (as defined in RAD TF-3: K.3.1).**

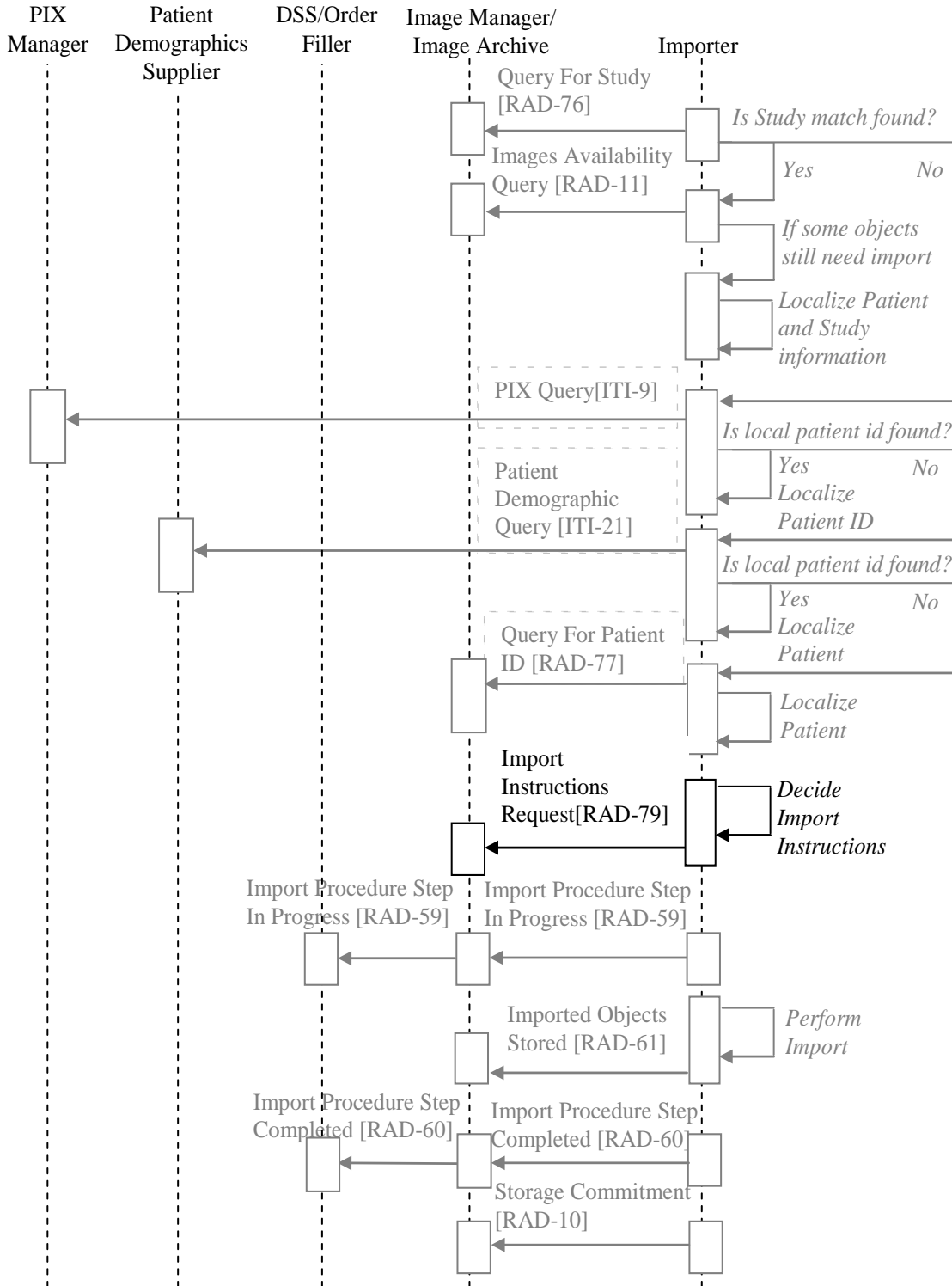

**Figure 21.3.1-6: Import Instruction Handling for the Unscheduled Import Method of Import Reconciliation Workflow Process Flow**

785 **For Scheduled Import in Import Reconciliation Workflow, an Image Manager/Archive supporting the Import Instruction Handling Option shall use the Import Instructions (as defined in RAD TF-3: K.3.1) provided in the Procedure Scheduled [RAD-4] transaction from the DSS/Order Filler. Refer to Figure 21.3.1-1 for the process flow.**

**For the Automated Order Placement and Scheduling Option, actors supporting the Import Instruction Handling Option shall support the following functionality:**

- 790
- **The Importer shall use the Request Filling of Order [RAD-78] transaction to convey the Import Instructions to the DSS/Order Filler.**
  - **The DSS/Order Filler shall provide the Import Instructions to the Image Manager/Archive in the Procedure Scheduled [RAD-4] transaction.**
  - **The Image Manager/Archive shall support using these Import Instructions (as defined in RAD TF-3: K.3.1). Refer to Figure 21.3.1-4 for the process flow.**
- 795

### **21.3.2 Import Exception Management Workflow**

Exception management Workflow is required for Import Reconciliation Workflow. This case addresses the need to manage errors generated through the Import Reconciliation Workflow such as:

- 800
- Selection of the incorrect Scheduled Procedure Step from the Modality Worklist.
  - Selection of the incorrect Patient Demographics from the Patient Demographics **Query response List**.
  - **Selection of the incorrect Patient ID from the results of Query for Patient ID.**
  - The inability to support the DICOM Composite Objects to be imported.
- 805
- Equipment Failure
  - Bad media

Some of these exception cases are addressed using required functionality for IHE actors in the Import Reconciliation Workflow and Scheduled Workflow Profiles, while others make use of the IMPORT PPS EXCEPTION MANAGEMENT (See RAD TF-3: 4.60.4.1.2.2). ~~**The following numbered items list exception cases that shall be supported by the actors listed in each item.**~~

810

### **21.3.3 Architecture**

**There are a number of possible network architectures that can be deployed for Import Reconciliation Workflow:**

- 815
- Importer is supported on a workstation located in the same facility as the local PACS to which it is sending the imported objects
  - Importer is actually integrated with the local PACS that is receiving the imported objects.

- Importer is supported on a workstation located in the same facility as the sending system, such as a centralized archive.

820 • Importer is actually integrated with the sending system, such as a centralized archive.

**There is no combined Importer/Image Manager defined in IRWF.b. An Importer that is integrated directly with an Image Manager/Archive implementation still shall support the Importer to Image Manager/Archive transactions in order to conform to the IRWF.b Profile.**

825 **The following examples illustrate two possible architectures to address these scenarios.**

**In this scenario, an automated pre-fetch functionality is being supported by a centralized archive for all imaging data. Based on local site policy, a corresponding order must be created and filled for any prior study sent from the centralized archive to a local PACS.**

830 **These requirements could be met by an Importer supporting the Automated Order Placement and Scheduling Option for IRWF.b. The Importer itself though could be associated with either the centralized archive or each of the local PACS as illustrated in the following two figures.**

835 **Note that in these examples the centralized archive is an Image Manager/Archive supporting the Scheduled Workflow Multiple Identity Resolution Option. For illustrative purposes, the centralized archive is supporting pre-fetch functionality by pushing DICOM objects to the Importer using the Image Manager Instances Stored [RAD-70] in response to receiving scheduled procedures. It is just as feasible that the Importer itself could be triggering the pre-fetches and retrieving the DICOM objects to be imported using the Image Manager Instances Retrieval or Retrieve Images transactions.**

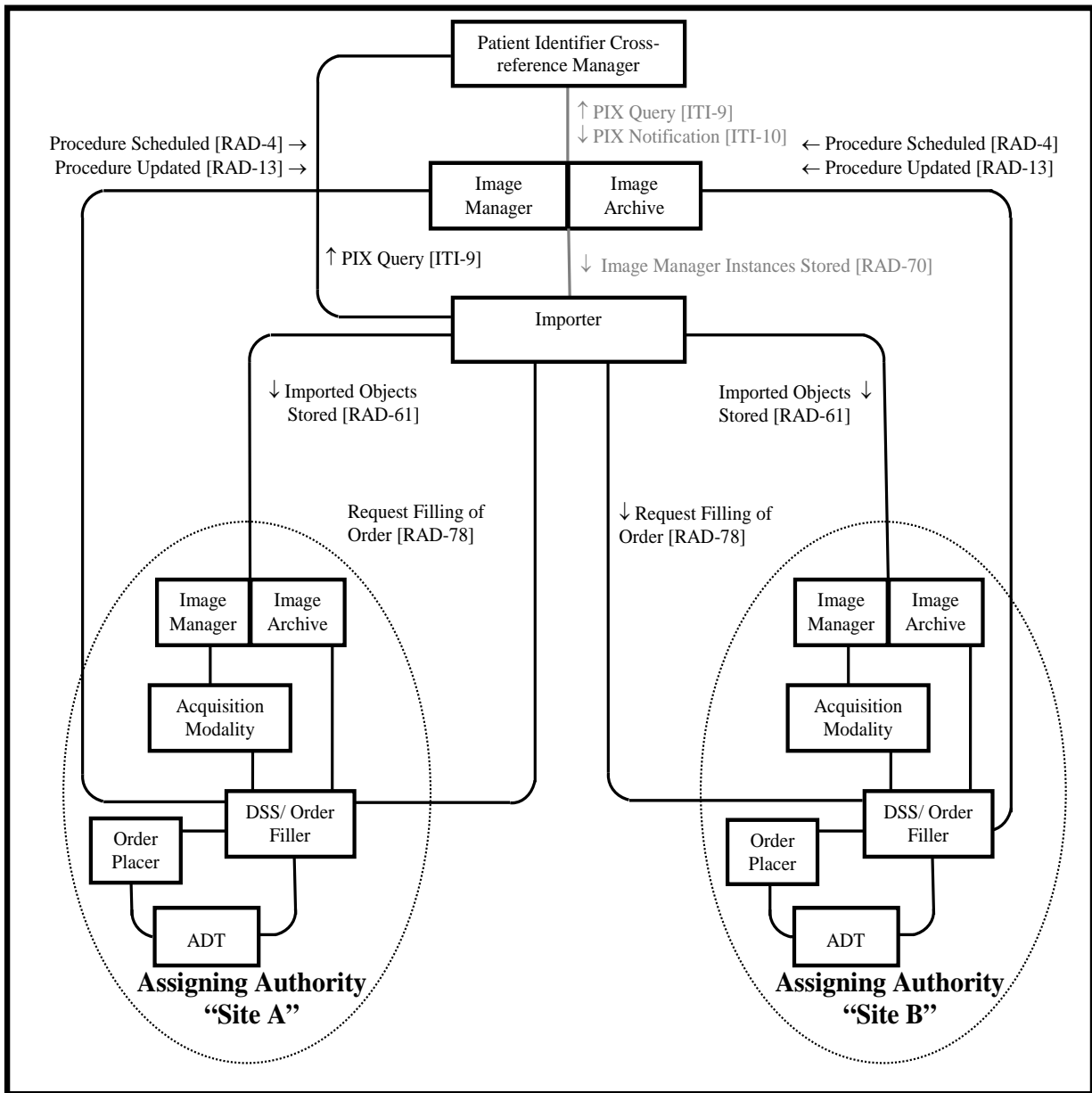

840

**Figure 21.3.3-1: Importer Associated with Centralized Archive**

845

**In the figure above, the Importer is illustrated as being logically separate from the centralized archive. However, it could actually be integrated with centralized archive in the same system. Note also that the IRWF.b Profile does not define any routing feature for the Importer so its ability to distinguish between the two Image Manager/Archives as the possible destinations would be an implementation specific feature.**

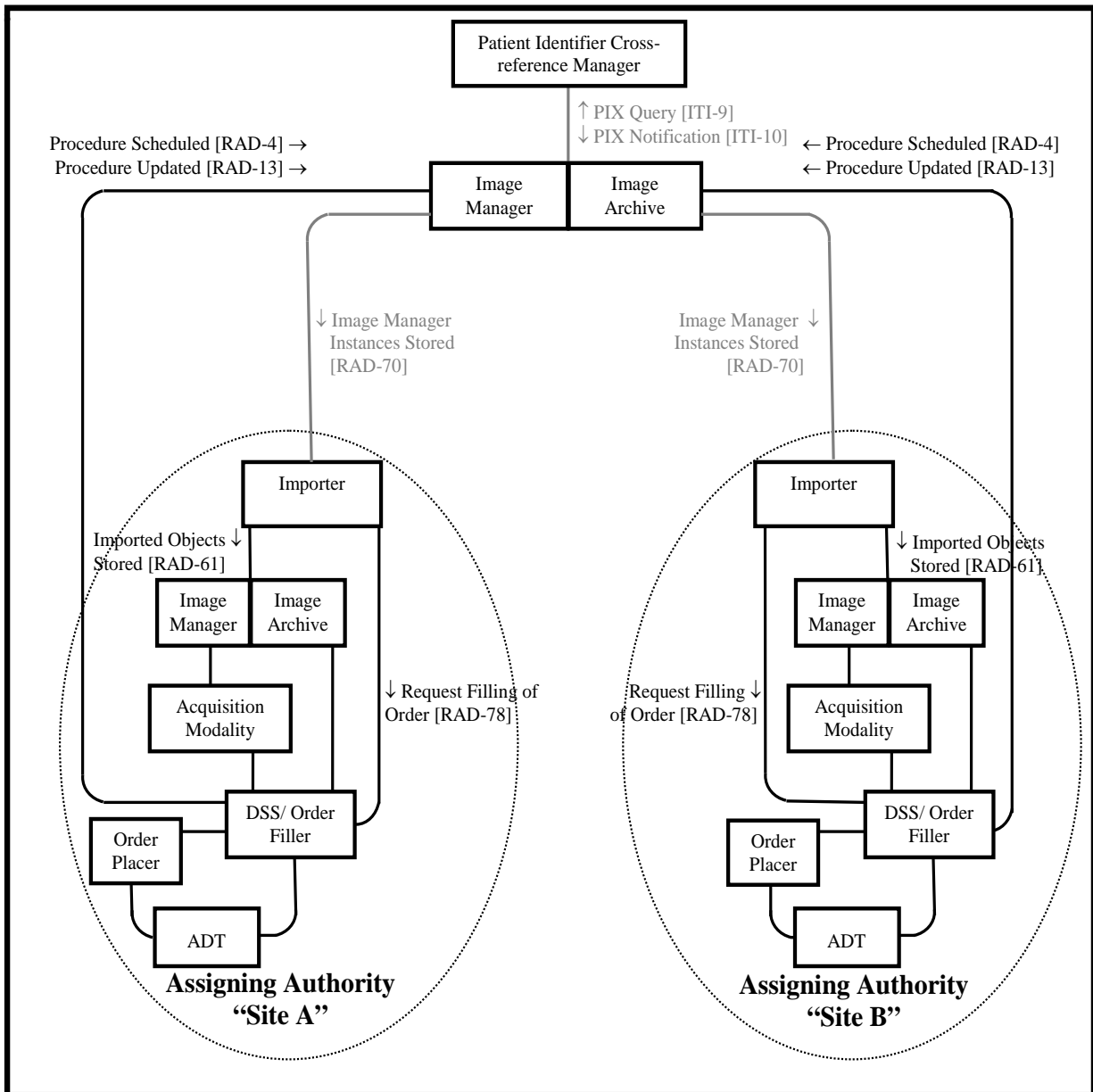

**Figure 21.3.3-2: Importer Associated with Local PACS**

850

**In the figure above, the Importers are illustrated as being logically separate from the local PACS. However, they could actually be integrated with local PACS in the same system (i.e., the Importer could be grouped with the local Image Manager/Archive itself). Note also that the Importers are not illustrated as using the PIX Query transaction because in this example the centralized archive Image Manager/Archive has already localized the patient identifiers based on preconfigured default assigning authorities to use for each Importer (as defined in the Image Manager Instances Stored [RAD-70] transaction).**

855

## Volume 2 – Transactions

860 *Modify TF vol 2; Section 4.4 Procedure Scheduled so that the DSS/Order Filler conveys the Import Instruction Codes in this transaction. The Import Instruction Codes could either be set manually on the DSS/Order Filler, or they could have to be set if provided by the Importer in the Request Filling of Order [RAD-78] transaction.*

*The modifications below are to the CP-RAD-213 text.*

### 4.4 Procedure Scheduled

865 ...

#### 4.4.4.1.2 Message Semantics

##### 4.4.4.1.2.1 Message Semantics (HL7 v2.3.1)

...

##### 4.4.4.1.2.1.5.1 Scheduled Protocol Sequence for Import

870 The Department System Scheduler/Order Filler participating in IRWF.b has the ability to provide Import Instructions (see RAD TF-2: 4.5-4) to the Image Manager on what should be done with the imported Evidence Objects after they are imported through the use of the Scheduled Protocol Code conveyed in the Universal Service ID, OBR-4, Components 4-6. Zero or more items may be present. The set of Scheduled Protocol Code values conveyed  
875 shall be identical to those provided in the corresponding Query Modality Worklist transaction.

##### 4.4.4.1.2.1.5.1.1 Automated Order Placement and Scheduling Option

880 The Department System Scheduler/Order Filler supporting the Automated Order Placement and Scheduling Option shall copy any Import Instructions (see RAD TF-2: 4.5-4) received in the Request Filling of Order [RAD-78] from an Importer to the Scheduled Protocol Code conveyed in the Universal Service ID, OBR-4, Components 4-6. Zero or more items may be present. See RAD TF-2: 4.5-4 for a list of the valid codes that may be used.

##### 4.4.4.1.2.1.5.1.2 Import Instruction Handling Option

885 The Department System Scheduler/Order Filler supporting the Import Instruction Handling Option shall support the ability for an operator to add and modify the Import Instructions (see RAD TF-2: 4.5-4). The selected Import Instruction shall be provided in the Scheduled Protocol Code conveyed in the Universal Service ID, OBR-4, Components 4-6. Zero or more items may be present.

890

#### 4.4.4.1.2.2 Message Semantics (HL7 v2.5.1 Option)

...

##### **4.4.4.1.2.2.8.1 Scheduled Protocol Sequence for Import**

895 **The Department System Scheduler/Order Filler participating in IRWF.b has the ability to provide instructions to the Image Manager on what should be done with the imported Evidence Objects after they are imported through the use of the Scheduled Protocol Code conveyed in the Protocol Code, IPC-6, Components 1-3. Zero or more items may be present. See RAD TF-2: 4.5-4 for a list of the valid codes that may be used. The set of Scheduled Protocol Codes conveyed shall be identical to those provided in the**  
900 **corresponding Query Modality Worklist transaction.**

##### **4.4.4.1.2.2.8.1.1 Automated Order Placement and Scheduling Option**

905 **The Department System Scheduler/Order Filler supporting the Automated Order Placement and Scheduling Option shall copy any import instructions received in the Request Filling of Order [RAD-78] from an Importer to the Scheduled Protocol Codes conveyed in the Protocol Code, IPC-6, Components 1-3. Zero or more items may be present. See RAD TF-2: 4.5-4 for a list of the valid codes that may be used.**

##### **4.4.4.1.2.2.8.1.2 Import Instruction Handling Option**

910 **The Department System Scheduler/Order Filler supporting the Import Instruction Handling Option shall support the ability for an operator to add and modify the Import Instructions (see RAD TF-2: 4.5-4). The selected Import Instruction shall be provided in the Scheduled Protocol Code conveyed in the Protocol Code, IPC-6, Components 1-3. Zero or more items may be present.**

#### **4.4.4.2 Expected Actions**

...

##### 915 **4.4.4.2.2 Import Instruction Handling Option**

**An Image Manager/Archive supporting the Import Instruction Handling Option shall support the following:**

- 920 • **Taking specific actions based on the provided Import Instructions (RAD TF-3: K.3.1).**



*Modify TF vol 2, Section 4.5 Query Modality Worklist to add the new “Do not archive” and “To be referenced” Import Instruction Codes.*

## 4.5 Query Modality Worklist

...

### 925 4.5.4.2.2.1 Scheduled Protocol Sequence for Import

The Department System Scheduler/Order Filler **in IRWF.b** has the ability to provide instructions to the Importer on what should be done with the imported Evidence Objects after they are imported through the use of the Scheduled Protocol Sequence (0040,0008). Zero or more items may be present. Table 4.5-4 provides a list of the valid codes that may be used.

930 If present the codes are intended to be made available for copying into the Performed Protocol Sequence (0040,0260) in order to convey the subsequent use of the instances. **Table 4.5-4 is used by transactions originating from both the Department System Scheduler/Order Filler and Importer. Therefore it differentiates between which codes can be set by these different actors.**

935

**Table 4.5-4: Import Instruction Codes**

<u>Category</u>	<u>Can Be Set By</u>	<u>Coding Scheme Designator (0008,0102)</u>	<u>Code Value (0008,0100)</u>	<u>Code Meaning (0008,0104)</u>
<u>Import Task</u>	<u>DSS/OF Importer</u>	99IHERADTF	IRWF001	Import
<u>Removable Media Handling</u>	<u>DSS/OF</u>	IHERADTF	IRWF008	Destroy original media
		IHERADTF	IRWF009	Return original media to patient
		IHERADTF	IRWF010	Return original media to sender
		IHERADTF	IRWF011	Archive original media
<u>Archive Instruction</u>	<u>DSS/OF Importer</u>	IHERADTF	IRWF003	To be archived
		<u>IHERADTF</u>	<u>IRWF012</u>	<u>Do not archive</u>
<u>Workflow Instruction</u>	<u>DSS/OF Importer</u>	IHERADTF	IRWF002	To be interpreted
		IHERADTF	IRWF004	To be over read
		IHERADTF	IRWF005	To be post-processed
		IHERADTF	IRWF006	To be printed
<u>Type of Data</u>	<u>DSS/OF Importer</u>	IHERADTF	IRWF007	To be provided as a prior
		<u>IHERADTF</u>	<u>IRWF013</u>	<u>To be sequestered for teaching</u>
		<u>IHERADTF</u>	<u>IRWF014</u>	<u>To be sequestered for research</u>

**4.5.4.2.2.1.1 Import Instruction Handling Option**

940 **A Department System Scheduler/Order Filler supporting the Import Instruction Handling Option shall support the ability for an operator to add and modify the Import Instructions (see RAD TF-2: 4.5-4). The selected Import Instruction shall be provided in the Scheduled Protocol Sequence (0040,0008). Zero or more items may be present.**

*Modify TF vol 2; Section 4.11 Images Availability Query to support the IRWF.b Unscheduled Import method.*

## 945 4.11 Images Availability Query

This section corresponds to Transaction RAD-11 of the IHE Technical Framework. Transaction RAD-11 is used by the Department System Scheduler, Report Manager, **Importer** and Image Manager actors.

### 4.11.1 Scope

950 **This transaction is used by the Department System Scheduler/Order Filler, Report Manager, and Importer to determine whether particular SOP Instances are available on an Image Manager.** The purpose ~~of this transaction is~~ for the Department System Scheduler/Order Filler and Report Manager **is** to determine whether SOP instances associated with a particular performed procedure step have been stored and are available for use in  
955 subsequent workflow steps as well as the storage location for retrieval of these SOP instances. **The purpose for the Importer is to determine whether SOP Instances being imported are already available on an Image Manager and thus do not need to be imported again.** The Image Manager is assumed to possess image availability information. The following examples show possible uses of the Images Availability Query:

- 960 • The Department System Scheduler/Order Filler queries the Image Manager after receiving notification, that images have been acquired (by MPPS N-SET message with PPS status of “COMPLETED” – see Transaction RAD-7) until it receives a list of all images listed in the PPS.
- 965 • The Department System Scheduler/Order Filler needs to verify the availability of prior images pre-fetched according to workflow rules. In this case the availability of a single image may have to be verified.
- 970 • The Report Manager queries the Image Manager after receiving notification, that images have been acquired (by MPPS N-SET message with PPS status of “COMPLETED” – see Transaction RAD-7) until it receives a list of all images listed in the PPS. At this time the Report Manager may schedule the appropriate task so that the reporting process can commence.
- 975 • The Report Manager needs to verify the availability of prior images pre-fetched according to workflow rules. In this case the availability of a single image may have to be verified.
- 975 • **The Importer queries the Image Manager after first determining that the Study being imported already exists on the Image Manager/Archive (see Query For Study [RAD-76] transaction). By determining if an object being imported is already available on the Image Manager, the Importer can decide whether or not to send it to the Image Manager.**

980 Image availability is determined by the fact that the Image Instance UID in question is returned in response to the query. However, for the purposes of workflow management, image availability is generally qualified with additional parameters, such as:

*Storage Location* describes a system or system component (for instance, an Image Archive) that can be identified as a holder of images at a particular period in time.

985 *Access Time* is a period of time that is required for images to be moved from a storage location to be ready for distribution; i.e., this does not take into consideration the outbound network transfer time or the performance of the receiver application to display the images. The exact access time is difficult to determine and is highly implementation-dependent. Nevertheless, it is possible to approximate access time by using a degree or  
990 level of image availability.

#### 4.11.2 Use Case Roles

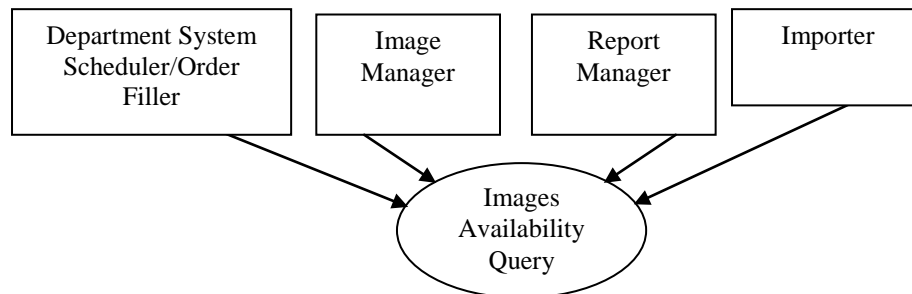

**Actor:** Department System Scheduler/Order Filler

995 **Role:** Queries Image Manager to determine availability of images for use in the processes according to department workflow (for example, interpretation)

**Actor:** Report Manager

**Role:** Queries Image Manager to determine availability of images for use in the processes according to department workflow (for example, interpretation)

1000 **Actor: Importer**

**Role: Queries Image Manager to determine whether images being imported are already available.**

**Actor:** Image Manager

1005 **Role: Supplies image availability information to Department System Scheduler/Order Filler, Report Manager, and Importer.**

#### 4.11.3 Referenced Standards

DICOM 2008 PS 3.4: Query/Retrieve Service Class.

#### 4.11.4 Interaction Diagram

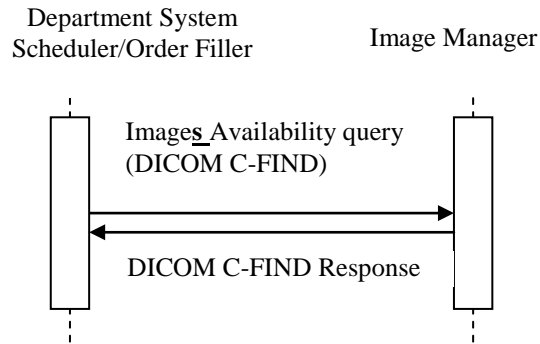

1010

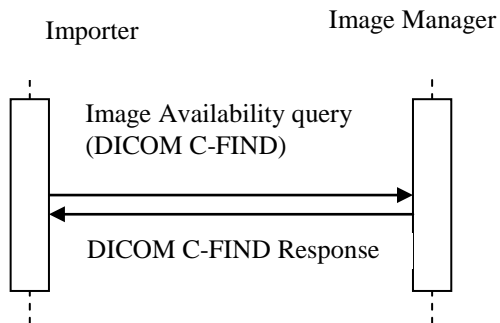
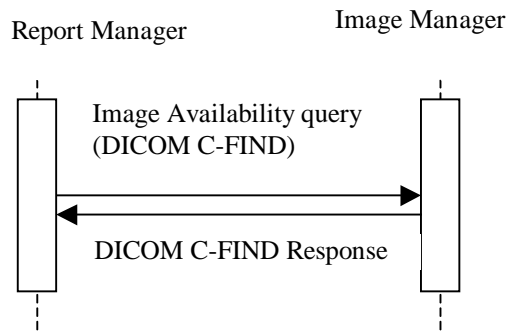

1015 **4.11.4.1 Query Image Availability**

**4.11.4.1.1 Trigger Events**

After receiving MPPS N-SET message with PPS status of “COMPLETED” or at a later time, the Department System Scheduler/Order Filler or Report Manager needs to verify image availability.

1020 **After receiving DICOM SOP Instances from removable media or over the network, an Importer checks to see if the Study for the objects to be imported already exists in the Image Manager/Archive using the Query For Study [RAD-76] transaction. If so then the Importer needs to verify image availability for the objects being imported.**

**4.11.4.1.2 Message Semantics**

1025 The Department System Scheduler/Order Filler, ~~or~~ Report Manager, **or Importer** issues a C-FIND request as specified in the DICOM Standard for the Study Root Query/Retrieve Information Model – FIND SOP Class. The Department System Scheduler/Order Filler, ~~and~~ Report Manager, **and Importer** must be configured with the AE information of the Image Managers to be queried. To obtain the list of images in question, the Department System Scheduler/Order Filler, ~~and~~ Report Manager, **and Importer** shall perform a query on the Image  
 1030 Level based on the specification in DICOM. The Hierarchical Search Method shall be supported. The following table highlights important attributes of the query. It is not the intent of this transaction to provide a mechanism for polling. The Department System Scheduler/Order Filler, ~~and~~ Report Manager, **and Importer** shall query the Image Manager with the minimal number of queries necessary. For example, if the purpose is to verify availability of all images in a series,  
 1035 DSS/OF shall not send queries on an image-by-image basis. In this case, a single, zero length value for the SOP Instance UID could be sent, then all matched images information will be returned.

**Table 4.11-1: Images Availability Query Keys**

Attribute	Tag	Query Key value
Query/Retrieve Level	(0008,0052)	IMAGE
Study Instance UID	(0020,000D)	Unique value for single-value match
Series Instance UID	(0020,000E)	Unique value for single-value match
SOP Instance UID	(0008,0018)	Single value, zero length value or list of UIDs

1040

Per the DICOM standard, Retrieve AE Title (0008,0054) shall be supported and returned by the Image Manager as part of the response.

1045 To better quantify Access Time, the optional attribute Instance Availability (0008,0056) with enumerated values of “ONLINE”, “NEARLINE” and “OFFLINE” may be used. In terms of access times and results of subsequent Retrieve (C-MOVE) request, the Image Availability values shall be interpreted as follows:

**Table 4.11-2: Image Access Time**

Level	Description	Access time
ONLINE	Images can be retrieved from storage location and be ready for distribution within a reasonable period of time (what time is reasonable is implementation-specific)	Typically, seconds to a few minutes
NEARLINE	Before distribution, images has to be processed at a storage location; total retrieval time is longer than “reasonable”	Typically, minutes to an hour
OFFLINE	Image cannot be distributed without human user intervention	Typically, minutes to hours to days

1050 **The Importer shall use the returned Instance Availability (0008,0056) value to determine whether or not to send SOP Instances to the Image Manager. If the query response indicates that a particular SOP Instance being imported by the Importer is either not available at all (no match) or is OFFLINE then the Importer shall send the SOP Instance to the Image Manager using the Imported Objects Stored [RAD-61]. If the SOP Instance is either ONLINE or NEARLINE on the Image Manager then the Importer shall not send the**

1055 **SOP Instance using the Imported Objects Stored [RAD-61] transaction.**

**Any SOP Instances to be sent will have their DICOM attributes first updated by the Importer to have the values that were returned earlier by the Query For Study [RAD-76] transaction. Refer to RAD TF-2: Appendix A.5-2 for the mapping.**

**4.11.4.1.3 Expected Actions**

1060 The Image Manager shall respond to the C-FIND as specified in the DICOM standard, including returning the SOP Instance UIDs (0008,0018) and corresponding Retrieve AE title (0008, 0054) when the match is successful.

1065

*It is not necessary to modify TF vol 2, Section 4.13 Procedure Updated so that the DSS/Order Filler can update the Import Instruction Codes in this transaction as the 4.13 text does not explicitly specify everything that can be updated and how. It essentially inherits from Section 4.4.*

### **4.13 Procedure Update**

...

1070



## Volume 3 – Transactions

*Modify TF vol 3; Section 4.59 Import Procedure Step In Progress to add the Automated Order Placement and Scheduling, and Import Instruction Handling options.*

### 4.59 Import Procedure Step In Progress

1075 This section corresponds to Transaction RAD-59 of the IHE Technical Framework. Transaction RAD-59 is used by the Department System Scheduler/Order Filler, Image Manager, Performed Procedure Step Manager, Report Manager, and Importer actors.

#### 4.59.1 Scope

1080 This transaction includes a message from the Importer to the Performed Procedure Step Manager, which in turn issues the message to the Department System Scheduler/Order Filler, the Image Manager and the Report Manager that the Performed Procedure Step is in progress.

1085 The receiving Performed Procedure Step Manager is grouped with the Image Manager or the Department System Scheduler/Order Filler, and shall support forwarding messages to two other destinations besides the actor it is grouped with. It shall start issuing messages to the configured destinations immediately after it accepts the corresponding messages from the Importer.

To allow for proper integration, the following considerations must be taken into account:

1090 The Performed Procedure Step Manager must maintain PPS objects and then store them until corresponding N-CREATE and N-SET messages are transmitted to the actor it is grouped with, and the two other Actors. If transmission to a destination fails, the Performed Procedure Step Manager shall try to repeat transmission periodically until it succeeds. The Performed Procedure Step Manager must not use failure of one or more of these transmissions as a reason for rejecting the initial transmission from the Importer;

1095 Because both the Image Manager and the Department System Scheduler/Order Filler incorporate the Performed Procedure Step Manager function, an infinite redistribution of PPS messages is possible. The Image Manager and the Department System Scheduler/Order Filler systems that provide the Performed Procedure Step Manager function shall be configurable to disable this function;

1100 Transfer of the information to the system that the receiving Performed Procedure Step Manager is integrated with is outside the scope of the IHE Technical Framework (i.e., internal to an implementation).

#### 4.59.2 Use Case Roles

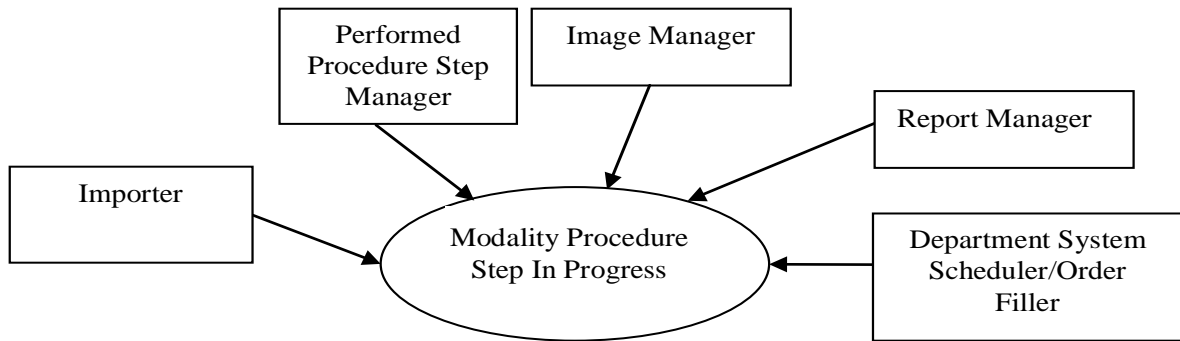

- 1105 **Actor:** Department System Scheduler/Order Filler.  
**Role:** Receives the PPS information forwarded by the PPS Manager.  
**Actor:** Image Manager.  
**Role:** Receives the PPS information forwarded by the PPS Manager.  
**Actor:** Report Manager.
- 1110 **Role:** Receives the PPS information forwarded by the PPS Manager.  
**Actor:** Importer.  
**Role:** Informs the Performed Procedure Step Manager that a particular Performed Procedure Step has started.  
**Actor:** Performed Procedure Step Manager.
- 1115 **Role:** Accepts Performed Procedure Step information from an Importer and transmits it to the Department System Scheduler/Order Filler, Image Manager and Report Manager.

#### 4.59.3 Referenced Standards

DICOM ~~2008~~ PS 3.4: Modality Performed Procedure Step SOP Class.

#### 4.59.4 Interaction Diagram

1120

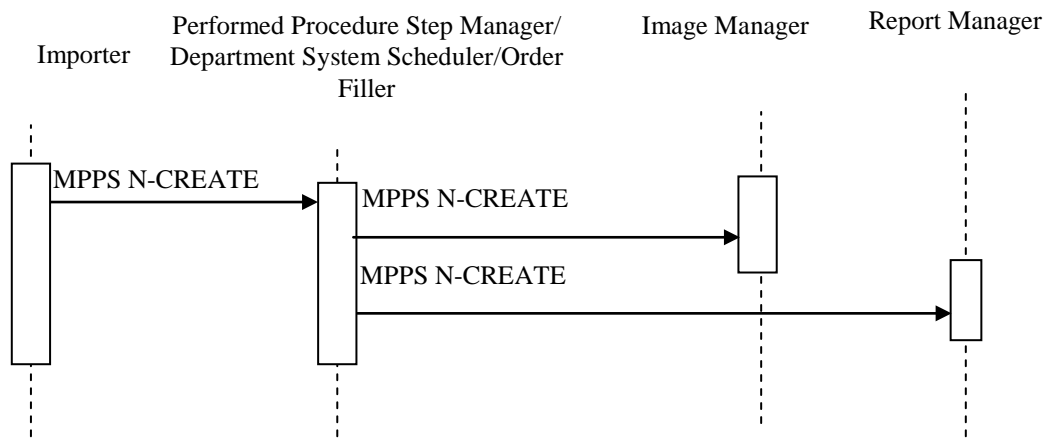
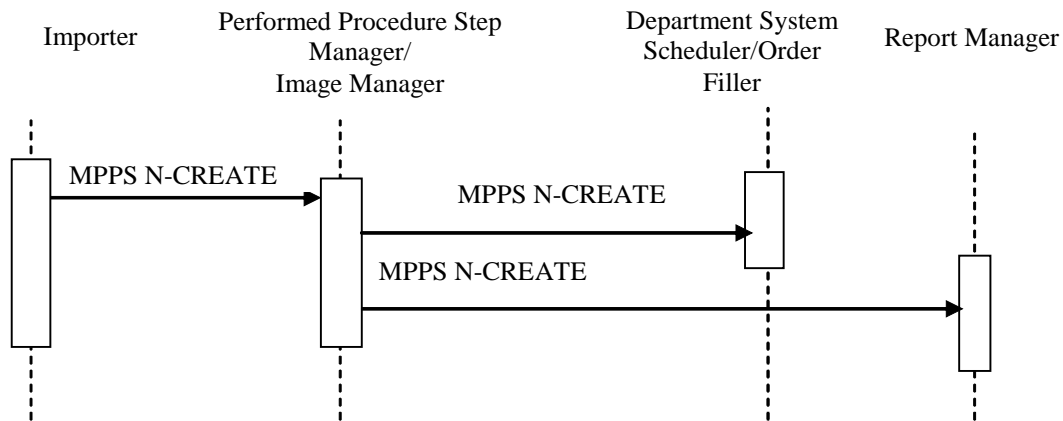

1125 **4.59.4.1 Procedure Step In Progress Message**

**4.59.4.1.1 Trigger Event**

The User begins the import procedure step from the Importer.

**4.59.4.1.2 Message Semantics**

1130 The Importer importing Evidence Objects into the Enterprise uses a Modality Performed  
 Procedure Step SOP Class (N-CREATE Service) to inform the Performed Procedure Step  
 Manager that a specific Procedure Step has been started and is in progress. In turn, the Performed  
 Procedure Step Manager uses the N-CREATE service to forward the information to the  
 Department System Scheduler/Order Filler, Image Manager and Report Manager. The Performed  
 Procedure Step Manager shall use the same Performed Procedure Step SOP Instance UIDs  
 1135 during this interchange. The following aspects shall be taken into account during implementation  
 of this step:

#### 4.59.4.1.2.1 Patient/Procedure/Scheduled Procedure Step Information

1140 The Importer shall ensure that the critical Patient information is valid and correct (See RAD TF-2: Appendix A.5). Additionally, if a Procedure Step has been scheduled for the importation it is also necessary to validate the Procedure information. Due to the fact that the Evidence Objects or Hardcopy to be imported are not native to the Enterprise, the validation process (by the User) of ensuring that the correct Patient is associated with the imported data is critical.

#### 4.59.4.1.2.2 Required Attributes

1145 RAD TF-2: Appendix A.5 lists a number of attributes that shall be coerced by the Importer to ensure consistency between the information included in the imported SOP instances, the Performed Procedure Step attributes, the Patient Demographic Information and the Scheduled Procedure Step information, if applicable.

#### 4.59.4.1.2.3 Relationship between Scheduled and Performed Procedure Steps and the Imported DICOM Composite Object

1150 When importing a DICOM Composite Object (e.g., from CD), the DICOM header information must either be preserved to ensure the integrity of the Study or coerced to fit within the local Enterprise. RAD TF-2: Appendix A.5 defines specific coercion requirement. For example, the Study Instance UID is one of the elements which must be maintained.

1155 The original scheduling and performing of the studies to be imported is outside of the venue of the Enterprise. For this reason, the association of Evidence Objects from a study to be imported may have relationships which are not easily described.

When digitizing Hardcopy and creating a new DICOM Composite Object, some of the original patient and study details may be derived from manual entry, OCR, configuration, etc. or may not be available. RAD TF-2: Appendix A.5 defines specific requirements.

1160 The relationship between Scheduled and Performed Procedure Step information for an importation is shown in the following 2 cases. Refer to RAD TF-2: Appendix A.5 for details of filling other attributes (Procedure ID, Accession Number, etc.) in each of these cases. In each case a MPPS N-Create Message is sent to notify the system that the performed procedure import is in progress

#### 1165 4.59.4.1.2.3.1 Scheduled Import

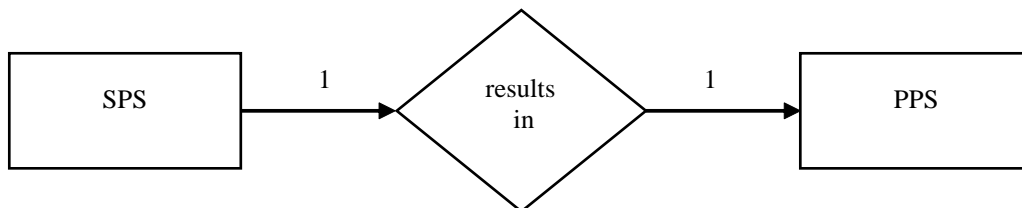

1170 In the ~~SCHEDULED IMPORT~~ **Scheduled Import method of import option**, the Scheduled Procedure Step information is provided by a Modality Worklist. There exists a 1-to-1 relationship between SPS and PPS. Information about the Scheduled Procedure Step and Requested Procedure shall be copied from the Scheduled Procedure Step object to the Performed Procedure Step Relationship Module (see RAD TF-2: Appendix A.5).

1175 Examples: A Procedure Step was performed exactly as scheduled. It could also be that a Procedure Step was not exactly performed as scheduled, but without being rescheduled, e.g., multiple Portable Media exist for a single Patient Study.

**4.59.4.1.2.3.2      Unscheduled Import**

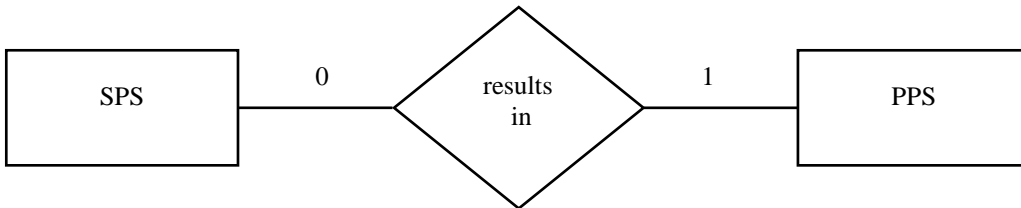

1180 In the ~~UNCHEDULED IMPORT~~ **Unscheduled Import method of import option** the Importer does not receive Scheduled information. There is a 0-to-1 relationship between SPS and PPS. ~~The Patient information is received through a Patient Demographics Query and no~~ **No** Scheduled Procedure Step or Requested Procedure information is available.

**4.59.4.1.2.3.3      Automated Order Placement and Scheduling**

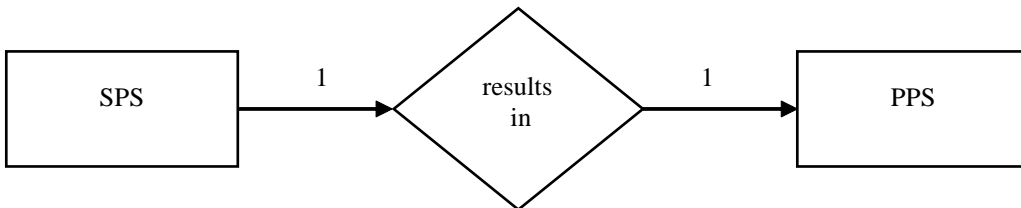

1185 **In the Automated Order Placement and Scheduling Option, the Scheduled Procedure Step information is provided to the Importer by a Request Filling of Order ORI (Success) message from the DSS/Order Filler (see RAD TF-3: 4.78.4.1.3). There exists a 1-to-1 relationship between SPS and PPS. Information about the Scheduled Procedure Step and Requested Procedure shall be copied from the Scheduled Procedure Step object to the Performed Procedure Step Relationship Module (see RAD TF-2: Appendix A.5).**

1190

**Examples: A Procedure Step was performed exactly as scheduled. It could also be that a Procedure Step was not exactly performed as scheduled, but without being rescheduled, e.g., multiple Portable Media exist for a single Patient Study.**

#### **4.59.4.1.2.3.34 Performed Protocol Sequence for Import**

1195 The Performed Protocol Code Sequence (0040,0260) shall be present in the Import Modality Performed Procedure Step. It is used to provide information on how the import should be handled (e.g., Interpret the Evidence Objects, Destroy the associated Media).

The Performed Protocol Code Sequence shall always contain one item with the value of (IRWF001, IHETFRAD, “Import”).

1200 *MPPS should not be used to convey Import Instructions so the following existing text is deleted.*

**~~In addition, if the Scheduled Protocol Code Sequence (0040,0008) exists, it shall be copied to the Performed Protocol Code Sequence (0040,0260), unless modified by the operator. For both the Scheduled and Unscheduled Import, the Importer may have the ability to add/modify the Import Instructions (see RAD TF-2:4.5-4).~~**

#### **1205 4.59.4.1.3 Expected Actions**

The Department System Scheduler/Order Filler, Report Manager and the Image Manager/Image Archive receive information from the Performed Procedure Step Manager and in the scheduled case, link it with the Requested Procedure and Scheduled Procedure Step.

1210 How the Performed Procedure Step Manager, Department System Scheduler/Order Filler, Report Manager and the Image Manager/Image Archive uses the information contained within the Performed Protocol Sequence is currently undefined.

#### **4.59.4.1.3.1 Import Instruction Handling Option**

1215 **The Image Manager/Archive supporting the Import Instruction Handling Option shall ignore the Import Instruction Codes provided in the Performed Protocol Code Sequence (0040,0260) of the Modality Performed Procedure Step. The Image Manager/Archive shall only act upon Import Instruction Codes received in the Procedure Scheduled [RAD-4], Procedure Update [RAD-13], or Import Instructions Request [RAD-79] transactions.**

1220

Modify TF vol 3, Section 4.61 Imported Objects Stored to add the Import Instruction Handling Option for an Image Manager, and make some corrections to the existing diagrams.

## 4.61 Imported Objects Stored

1225 This section corresponds to Transaction RAD-61 of the IHE Technical Framework. Transaction RAD-61 is used by the Image Archive and the Importer actors.

### 4.61.1 Scope

1230 In the Imported Objects Stored transaction, the Importer sends the Evidence Objects to the Image Archive. ~~The reconciled information provided from the Modality Worklist transaction (see RAD TF-2: 4.5) or the Patient Demographics Query (see ITI TF-2a:4.21) shall be included in the headers of the generated images.~~ The Importer shall reconcile the patient information in the headers of the Evidence Objects prior to sending them.

### 4.61.2 Use Case Roles

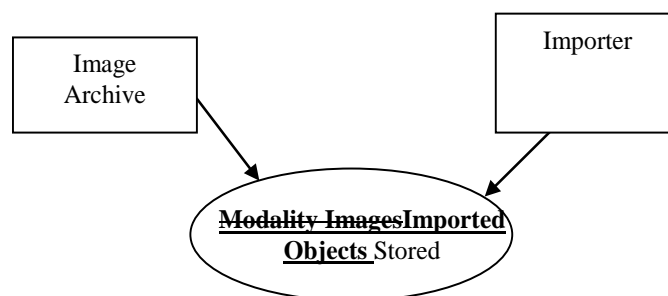

1235 **Actor:** Image Archive

**Role:** Accept and store DICOM Composite Objects from the Portable Media Importer.

**Actor:** Importer

**Role:** Transmit imported DICOM object data to Image Archive

### 4.61.3 Referenced Standards

1240 DICOM ~~2008~~ PS 3.4: Storage Service Class, Section B.4.1 Conformance as an SCP

DICOM ~~2008~~ PS 3.3 SOP Information Objects, Common Module Attribute

#### 4.61.4 Interaction Diagram

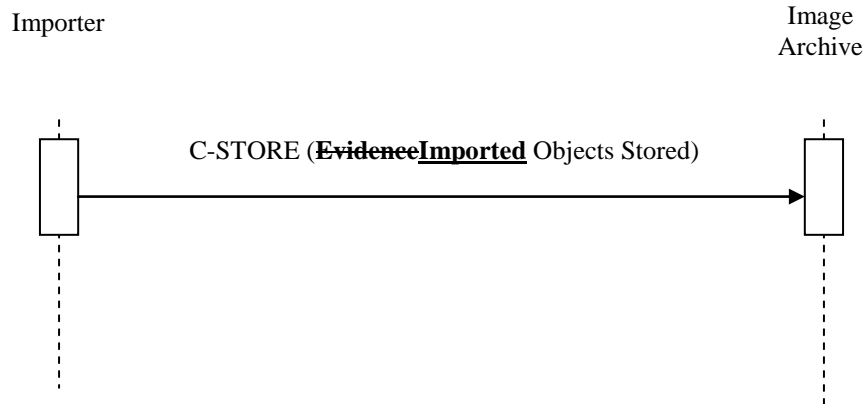

#### 1245 4.61.4.1 EvidenceImported Objects Stored

##### 4.61.4.1.1 Trigger Events

The Importer can transfer EvidenceImported objects to the Image Archive sequentially within one or more DICOM associations, as the Evidence objects become available or collectively.

##### 4.61.4.1.1.1 UIDs

1250 Valid DICOM UIDs are universally unique, so there should be no risk of collision with local UIDs. When a valid set of DICOM UIDs is present, the importer shall use this set and not change them. If the importer detects incorrect UIDs or an inconsistent set of UIDs, then it may correct or re-generate UIDs. The UIDs are used as references between objects, and if they are altered, the Importer shall maintain referential integrity. Additional details about when it is appropriate for an Importer to trigger the creation of a new Study/Series/Image Instance are described in RAD TF-2: 4.8.4.1.1.1 “Study UIDs and Series UIDs”.

1255

##### 4.61.4.1.2 Message Semantics

The Importer uses the DICOM C-STORE message to transfer the DICOM Composite Objects. The Importer is the DICOM Storage SCU and the Image Archive is the DICOM Storage SCP.

1260 If the import was scheduled, the UserImporter validates the available information for the patient and the Scheduled Procedure Step/Requested Procedure and coerces the Patient/Order Information as required (See Section RAD TF-2: Appendix A.5).

If the import was not scheduled, the UserImporter validates the available information for the patient and coerces the Patient Information as required (See Section RAD TF-2: Appendix A.5).

1265 It is a requirement that certain information be recorded in the image header. The details of the mapping to DICOM instances are specified in RAD TF-2: Appendix A.5.



Per the DICOM Standard, the Importer shall create a new series for its created images (e.g., Digitization of Films) and not extend series containing source images.

**4.61.4.1.2.1 Original Attributes Sequence**

1270 When coercing (i.e., replacing or deleting attributes) from the original Evidence Objects, the Importer shall create or add to the “Original Attributes Sequence” (See Table 4.61.4.1.2-1) at the top level and store the original values of those altered DICOM elements underneath it as defined in RAD TF-2: Appendix A.5.

1275 The Importer shall use the “Original Attribute Sequence” to preserve information about the original non-digitized data (e.g., Originating Institution, Time of the import, specific attributes from the originating Institution). The mechanism and values which are preserved is out of scope for the Technical Framework.

**Table 4.61.4.1.2-1: Original Attributes Sequence**

Attribute Name	Tag	Type	Attribute Description
...			
Original Attributes Sequence (Note 1,2)	(0400,0561)	R+	Sequence of Items containing all attributes that are specified by the User from the Original dataset. One or more Items may be permitted in this sequence.
>Source of Previous Values	(0400,0564)	R+	Identification of the Enterprise which originated the Films or Documents.
>Attribute Modification Datetime	(0400,0562)	R	Date and Time of the hardcopy scan
>Modifying System	(0400,0563)	R	Identification of the local Enterprise
>Reason for the Attribute Modification	(0400,0565)	R	Reason for the attribute modification. Defined terms are: COERCE = Replace values of attributes such as Patient Name, ID, Accession Number, for example, during import of media from an external institution, or reconciliation against a master patient index. CORRECT = Replace incorrect values, such as Patient Name or ID, for example, when incorrect worklist item was chosen or operator input error.
>Modified Attribute Sequence	(0400,0550)	R	Sequence containing a single item that contains all the Attributes that supplied by the User from the Original Films or Documents.
>>Any Attribute from the main data set that was modified			

1280

Note 1: A new original attribute sequence is added every time the DICOM Objects are imported.

Note 2: For digitized hardcopy the “old values” would be information the operator manually enters. It is expected that there would be only one sequence in this case.

**4.61.4.1.2.2 Contributing Equipment Sequence**

1285 In order to preserve the fact that these Evidence Objects have been imported into the Enterprise,  
the Contributing Equipment Sequence shall be used (see Table 4.61.4.1.2-2). This will allow the  
local Institution to make decisions based upon the fact that a set of Evidence Objects has been  
imported (e.g., Schedule an over-read based upon an import, delete the imported Evidence  
1290 Objects after a prescribed amount of time). The behavior of how Imported Evidence Objects are  
used and maintained is out of scope of the Technical Framework.

**Table 4.61.4.1.2-2: Contributing Equipment Sequence**

Attribute Name	Tag	Type	Attribute Description
>Purpose of Reference Code Sequence	(0040,A170)	R	Describes the purpose for which the related equipment is being referenced. See C.12.1.1.4 for further explanation. (See Table 4.61.4.1.2-3)
>>Include 'Code Sequence Macro' Table 8.8-1			Defined Context ID 7005.
>Manufacturer	(0008,0070)	R	Manufacturer of the equipment that contributed to the composite instance. (Manufacturer of Portable Media Importer or Digitizer.)
>Institution Name	(0008,0080)	R+	Institution where the equipment that contributed to the composite instance is located. (Institution where the Import is being done.)
>Station Name	(0008,1010)	R+	User defined name identifying the machine that contributed to the composite instance. (User defined name identifying the machine that is performing the import.)
>Contribution DateTime	(0018,A002)	R+	The Date & Time when the equipment contributed to the composite instance. (The Date & Time of the import.)

The following table should be used to provide describe the equipment that has done the import.  
This information may be used by an Institution at a later time to take actions specific to data  
1295 imported into the Enterprise.

**Table 4.61.4.1.2-3: Context ID 7005 – Contributing Equipment  
Most Restrictive Use: Defined**

Coding Scheme Designator (0008,0102)	Code Value (0008,0100)	Code Meaning (0008,0104)
DCM	MEDIM	Portable Media Importer Equipment
DCM	FILMD	Film Digitizer <b>Equipment</b>
DCM	DOCD	Document Digitizer Equipment
DCM	VIDD	Video Tape Digitizer Equipment

#### **4.61.4.1.3 Expected Actions**

1300 The Image Archive will store the received DICOM objects.

The DICOM Images, Evidence Documents and Diagnostic Reports shall be stored such that they can be later retrieved (See RAD TF- 2:4.16, RAD TF-2:4.17, RAD TF-2:4.27 and RAD TF-2:4.3 ) in a fashion meeting the requirements defined for a DICOM Level 2 Storage SCP (Refer to DICOM PS 3.4 B.4.1).

#### **1305 4.61.4.1.3.1 Import Instruction Handling Option**

**An Image Manager supporting the Import Instruction Handling Option shall have the ability to use the Import Instructions (see RAD TF-2: 4.5-4) provided in the Procedure Scheduled [RAD-4], Procedure Update [RAD-13], or Import Instructions Request [RAD-79] transaction corresponding to the received DICOM objects.**

1310 **Specific to this transaction, the Image Manager shall support:**

- **Image Manager Import Instruction Code Handling (RAD TF-3: K.3.1)**

#### **4.61.4.1.3.1 4.61.4.1.3.2 DICOM Storage SOP Classes**

1315 The DICOM Standard defines a number of image specific storage SOP classes, as well as other DICOM SOP Classes for DICOM SR, encapsulated PDFs, etc. All standard attributes and private elements shall be stored.

1320 It is expected that the product's DICOM Conformance Statement will state which DICOM Storage SOP Classes it claims to support. Non-supported SOP Classes shall be rejected by the Image Manager/ Image Archive in the C-Store association. How the Institution deals with situations where DICOM Objects from the Importer cannot be stored is out of scope of the Technical Framework.

*Add TF vol 3, Section 4.76 Query For Study to support the IRWF.b Unscheduled Import method of import.*

1325 **4.76 Query For Study**

This section corresponds to Transaction RAD-76 for the IHE Technical Framework. Transaction RAD-76 is used by the Image Manager/Archive and Importer actors.

**4.76.1 Scope**

The Importer queries the Image Manager/Archive to find out if a study already exists.

1330 **4.76.2 Use Case Roles**

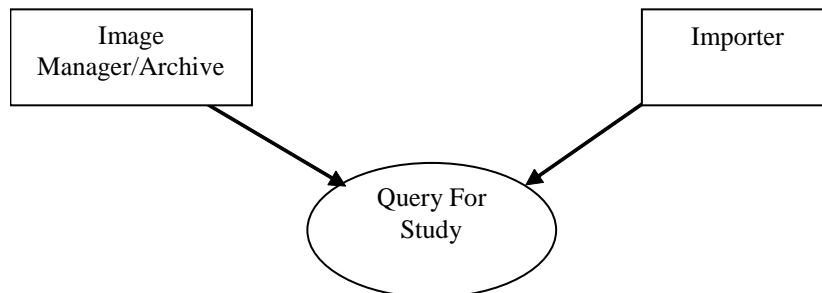

**Actor:** Image Manager/Archive

**Role:** Responds to queries for Studies.

1335 **Actor:** Importer

**Role:** Issues Queries for Studies.

**4.76.3 Referenced Standards**

DICOM PS 3.4: Query/Retrieve Service Class

1340 **4.76.4 Interaction Diagram**

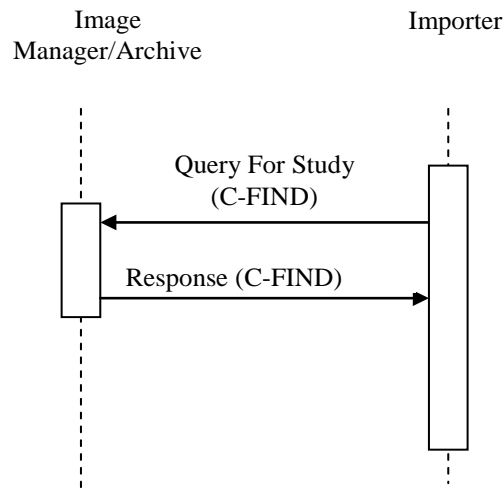

**4.76.4.1 Query For Study**

1345 The Query (Study Root – FIND) SOP Class shall be supported. Refer to DICOM PS 3.4 for detailed descriptive semantics. The Importer is the SCU; the Image Manager/Archive is the SCP.

**4.76.4.1.1 Trigger Events**

The Importer checks to see if the Study to be imported already exists in the Image Manager/Archive.

**4.76.4.1.2 Message Semantics**

1350 The message semantics are defined by the DICOM Query/Retrieve SOP Classes.

A C-FIND Request from the DICOM Study Root Query/Retrieve Information Model – FIND SOP Class shall be sent from the Importer to the Image Manager/Archive. Hierarchical Search Method shall be supported.

1355 The Importer uses the Study Instance UID of the DICOM object(s) being imported as the search criteria to determine if there is a matching entry in the Image Manager/Archive at the Study level. If a match is returned, then the Importer uses the returned Patient ID to check whether or not all the DICOM objects for the Study to be imported already exist in the Image Manager/Archive using the Images Availability Query [RAD-11] transaction. If one or more of the DICOM objects have not yet been imported then the Importer uses the returned patient and study values from the results of the Query For Study [RAD-76] (as specified in RAD TF-2: Appendix A.5) to update the DICOM object headers and then sends them to the Image Manager/Archive using the Imported Objects Stored [RAD-61] transaction.

1360

The matching keys and return keys to be supported by the Importer (SCU) and the Image Manager/Archive (SCP) are defined in the table below. The table specifies for both the Query

1365 SCU (Importer) and the Query SCP (Image Manager/Archive) if Matching Keys (keys used as matching criteria in the Query request) and Returned Keys (Keys used to request attributes to be returned in the query responses) are Required (R) or Optional (O). See RAD-TF 2: 2.2 for more information.

1370 **Table 4.76.4.1.2-1: Query For Study Matching and Return Keys**

Attributes Name	Tag	Query Keys Matching		Query Keys Return		Notes
		SCU	SCP	SCU	SCP	
Study Level						
Study Date	(0008,0020)	O	R	R+	R	
Study Time	(0008,0030)	O	R	R+	R	
Accession Number	(0008,0050)	O	R	R+	R	
Issuer of Accession Number Sequence	(0008,0051)					IHE-3
>Local Namespace Entity ID	(0040,0031)	O	R+	R+	R+	
>Universal Entity ID	(0040,0032)	O	R+	R+	R+	
>Universal Entity ID Type	(0040,0033)	O	R+	R+	R+	
Patient Name	(0010,0010)	O	R	R+	R	IHE-1, IHE-2
Patient ID	(0010,0020)	O	R	R+	R	
Issuer of Patient ID	(0010,0021)	O	R+	R+	R+	
Issuer of Patient ID Qualifiers Sequence	(0010,0024)					
>Universal Entity ID	(0040,0032)	O	O	O	O	
>Universal Entity ID Type	(0040,0033)	O	O	O	O	
>Identifier Type Code	(0040,0035)	O	O	O	O	
Study ID	(0020,0010)	O	R	R+	R	

IHE Radiology Technical Framework Supplement – Import Reconciliation Workflow (IRWF.b)

Attributes Name	Tag	Query Keys Matching		Query Keys Return		Notes
		SCU	SCP	SCU	SCP	
Study Instance UID	(0020,000D)	R+*	R	R+*	R	IHE-4
Modalities in Study	(0008,0061)	O	R+	R+	R+	
Referring Physician's Name	(0008,0090)	O	R+	R+	R+	IHE-1, IHE-2
Study Description	(0008,1030)	O	O	O	O	
Procedure Code Sequence	(0008,1032)					
>Code Value	(0008,0100)	O	O	O	O	
>Coding Scheme Designator	(0008,0102)	O	O	O	O	
>Coding Scheme Version	(0008,0103)	O	O	O	O	
>Code Meaning	(0008,0104)	O	O	O	O	
Name of Physician(s) Reading Study	(0008,1060)	O	O	O	O	IHE-1, IHE-2
Admitting Diagnoses Description	(0008,1080)	O	O	O	O	
Referenced Study Sequence	(0008,1110)					
>Referenced SOP Class UID	(0008,1150)	O	O	O	O	
>Referenced SOP Instance UID	(0008,1155)	O	O	O	O	
Referenced Patient Sequence	(0008,1120)					
>Referenced SOP Class UID	(0008,1150)	O	O	O	O	
>Referenced SOP Instance UID	(0008,1155)	O	O	O	O	
Patient's Birth Date	(0010,0030)	O	O	R+	R+	
Patient's Birth Time	(0010,0032)	O	O	O	O	
Patient's Sex	(0010,0040)	O	O	R+	R+	
Other Patient IDs	(0010,1000)	N/A	N/A	N/A	N/A	IHE-5
Other Patient Names	(0010,1001)	O	O	O	O	IHE-1, IHE-2
Patient's Age	(0010,1010)	O	O	O	O	
Patient's Size	(0010,1020)	O	O	O	O	
Patient's Weight	(0010,1030)	O	O	O	O	
Ethnic Group	(0010,2160)	O	O	O	O	
Occupation	(0010,2180)	O	O	O	O	
Additional Patient History	(0010,21B0)	O	O	O	O	

Attributes Name	Tag	Query Keys Matching		Query Keys Return		Notes
		SCU	SCP	SCU	SCP	
Patient Comments	(0010,4000)	O	O	O	O	
Other Study Numbers	(0020,1070)	O	O	O	O	
Number of Patient Related Studies	(0020,1200)	N/A	N/A	O	O	
Number of Patient Related Series	(0020,1202)	N/A	N/A	O	O	
Number of Patient Related Instances	(0020,1204)	N/A	N/A	O	O	
Number of Study Related Series	(0020,1206)	N/A	N/A	O	R+	
Number of Study Related Instances	(0020,1208)	N/A	N/A	O	R+	
Interpretation Author	(4008,010C)	O	O	O	O	IHE-1, IHE-2

**Note:** For a description of the notation/ modifiers used in the above table, see RAD TF-2: 2.2.

**IHE-1:** Case insensitive matching is allowed for attributes of VR PN per DICOM PS 3.4.

**IHE-2:** SCUs are recommended to append wildcard "\*" at the end of each component of any structured name to facilitate matching (i.e., PN attributes).

1375 **IHE-3:** Universal Matching (selecting return keys) against an Attribute of VR SQ, may be requested by the Query SCU using a Zero Length Sequence Attribute. Query SCPs shall accept such Universal Match Requests. In addition, Query SCPs are required by the DICOM Standard to support requests for a Universal Match for an SQ attribute encoded as a zero length item.

1380 **IHE-4:** SCU shall include the Study UID of the DICOM object(s) to be imported as the Matching Key in queries.

**IHE-5:** Other Patient IDs (0010,1000) attribute shall not be used. It is redundant with Other Patient IDs Sequence (0010,1002) and insufficient as it does not allow the Assigning Authority to be conveyed for each Patient ID.

1385

#### 4.76.4.1.3 Expected Actions

The Image Manager/Archive receives the C-FIND request, performs the matching on the provided keys and sends the list of matching records back to the Importer via C-FIND responses.



1390 **4.76.5 Security Considerations**

**4.76.5.1 Security Audit Considerations**

The Radiology Audit Trail Option in the IHE ITI Audit Trail and Node Authentication Profile (ITI TF-1:9) defines audit requirements for IHE Radiology transactions. See RAD TF-3:5.

1395 *Add TF vol 3, Section 4.77 Query For Patient ID to support the IRWF.b Unscheduled Import method of import.*

## 4.77 Query For Patient ID

This section corresponds to Transaction RAD-77 for the IHE Technical Framework. Transaction RAD-77 is used by the Image Manager/Archive and Importer actors.

### 1400 4.77.1 Scope

The Importer queries the Image Manager/Archive to find the local patient identifier corresponding to the patient demographics in the objects to be imported.

### 4.77.2 Use Case Roles

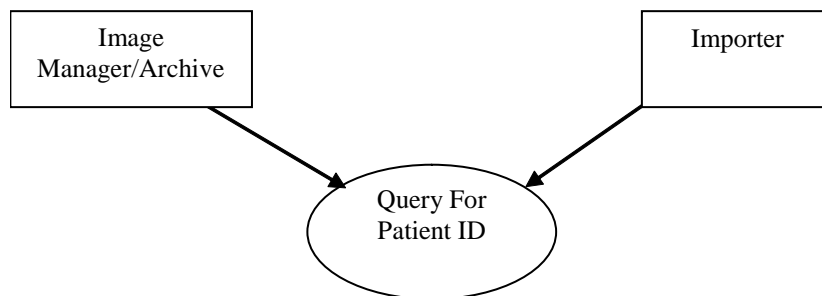

1405

**Actor:** Image Manager/Archive

**Role:** Responds to queries for Patient ID.

**Actor:** Importer

**Role:** Issues Queries for Patient ID

### 1410 4.77.3 Referenced Standards

DICOM PS 3.4: Query/Retrieve Service Class

#### 4.77.4 Interaction Diagram

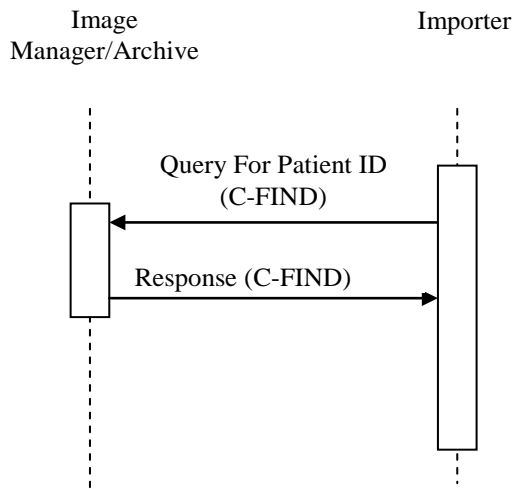

1415

##### 4.77.4.1 Query For Patient ID

The Query (Patient Root – FIND) SOP Class shall be supported. Refer to DICOM PS 3.4 for detailed descriptive semantics. The Importer is the SCU; the Image Manager/Archive is the SCP.

##### 4.77.4.1.1 Trigger Events

1420 The Importer needs to find the local patient ID before importing the objects.

##### 4.77.4.1.2 Message Semantics

The message semantics are defined by the DICOM Query/Retrieve SOP Classes.

1425 A C-FIND Request from the DICOM Patient Root Query/Retrieve Information Model – FIND SOP Class shall be sent from the Importer to the Image Manager/Archive. Hierarchical Search Method shall be supported.

The Importer uses the Patient Name, and other patient demographics if provided, of the DICOM object(s) being imported as the search criteria to determine if there is a matching entry in the Image Manager/Archive at the Patient level.

1430 If multiple matching patients are returned then the Importer shall support mechanisms for resolving the correct patient (such as through a user interface, exception list, or other approach).

1435 The matching keys and return keys to be supported by the Importer (SCU) and the Image Manager/Archive (SCP) are defined in the table below. The table specifies for both the Query SCU (Importer) and the Query SCP (Image Manager/Archive) if Matching Keys (keys used as matching criteria in the Query request) and Returned Keys (Keys used to request attributes to be returned in the query responses) are Required (R) or Optional (O). See RAD-TF 2: 2.2 for more information.

**Table 4.77.4.1.2-1: Query For Patient ID Matching and Return Keys**

Attributes Name	Tag	Query Keys Matching		Query Keys Return		Notes
		SCU	SCP	SCU	SCP	
<b>§ Patient Level</b>						
Patient Name	(0010,0010)	R+	R	R+	R	IHE-1, IHE-2
Patient ID	(0010,0020)	O	R	R+	R	
Issuer of Patient ID	(0010,0021)	O	R+	R+	R+	
Issuer of Patient ID Qualifiers Sequence	(0010,0024)					
>Universal Entity ID	(0040,0032)	O	O	O	O	
>Universal Entity ID Type	(0040,0033)	O	O	O	O	
>Identifier Type Code	(0040,0035)	O	O	O	O	
Patient's Birth Date	(0010,0030)	O	O	R+	R+	
Patient's Sex	(0010,0040)	O	O	R+	R+	
Other Patient IDs	(0010,1000)	N/A	N/A	N/A	N/A	IHE-3
Other Patient Names	(0010,1001)	O	O	O	O	IHE-1, IHE-2
Patient's Age	(0010,1010)	O	O	O	O	
Patient's Size	(0010,1020)	O	O	O	O	
Patient's Weight	(0010,1030)	O	O	O	O	
Ethnic Group	(0010,2160)	O	O	O	O	
Occupation	(0010,2180)	O	O	O	O	

**Note:** For a description of the notation/ modifiers used in the above table, see RAD TF-2: 2.2.

1440

**IHE-1:** Case insensitive matching is allowed for attributes of VR PN per DICOM PS 3.4.

**IHE-2:** SCUs are recommended to append wildcard "\*" at the end of each component of any structured name to facilitate matching (i.e., PN attributes).

**IHE-3:** Other Patient IDs (0010,1000) attribute shall not be used. It is redundant with Other Patient IDs Sequence (0010,1002) and insufficient as it does not allow the Assigning Authority to be conveyed for each Patient ID.

1445

#### 4.77.4.1.3 Expected Actions

The Image Manager/Archive receives the C-FIND request, performs the matching on the provided keys and sends the list of matching records back to the Importer via C-FIND responses.

1450 **4.77.5 Security Considerations**

**4.77.5.1 Security Audit Considerations**

The Radiology Audit Trail Option in the ITI Audit Trail and Node Authentication Profile (ITI TF-1:9) defines audit requirements for IHE Radiology transactions. See RAD TF-3:5.

1455 *Add TF Vol 3, Section 4.78 Request Filling of Order to support the IRWF.b Automated Order Placement and Scheduling Option.*

## 4.78 Request Filling of Order

This section corresponds to Transaction RAD-78 of the IHE Technical Framework. Transaction RAD-78 is used by the Importer and Department System Scheduler/Order Filler actors.

### 1460 4.78.1 Scope

This transaction is used by the Importer to create and fill an order with the DSS/Order Filler. The DSS/Order Filler in turn informs the Order Placer about the order it creates and then returns the placed and filled order information to the Importer. Once the order has been filled, the Importer cannot change or cancel it. Only the DSS/Order Filler can change or cancel the order.

### 1465 4.78.2 Use Case Roles

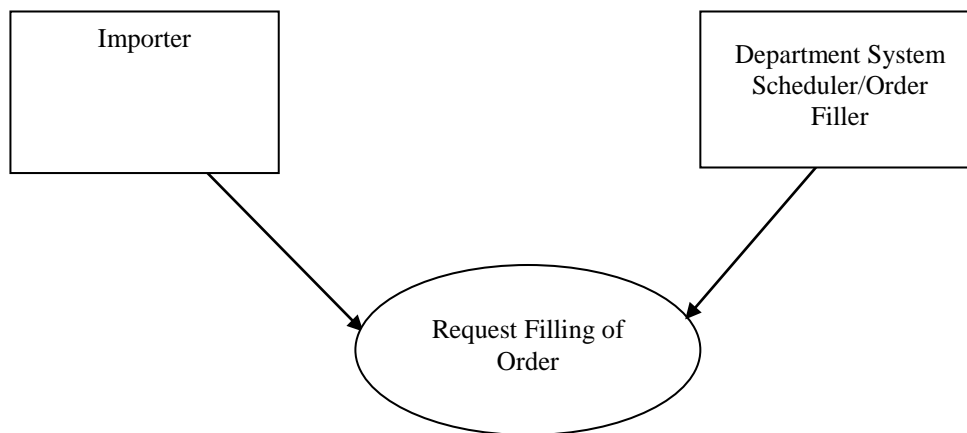

**Actor:** Importer

**Role:** Triggers scheduling of order on the Department System Scheduler/Order Filler.

**Actor:** Department System Scheduler/Order Filler

1470 **Role:** Receives and processes (fills) order requests.

### 4.78.3 Referenced Standards

HL7 2.5.1 Chapter 4

#### 4.78.4 Interaction Diagram

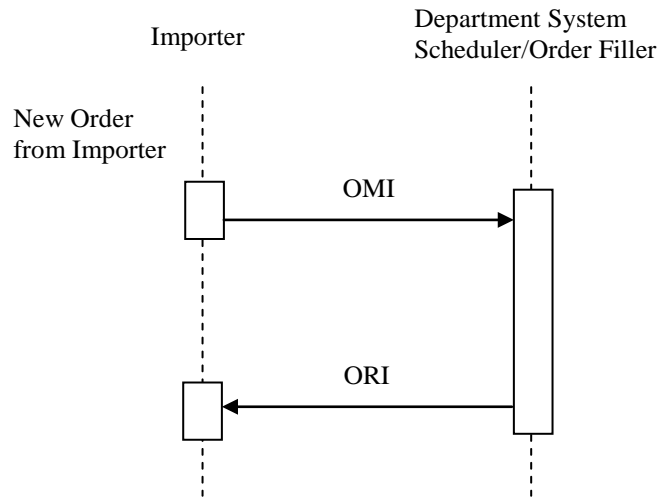

#### 1475 4.78.4.1 Order Management – Order Filled from Importer

##### 4.78.4.1.1 Trigger Events

**OMI** - The Importer determines the procedure which needs to be performed to fill the order for the imported Study. The Importer supporting the IRWF.b Automated Order Placement and Scheduling Option triggers the creation of the new order after the local patient identifier for the imported objects is identified.

1480

**ORI** – Department System Scheduler/Order Filler replies.

##### 4.78.4.1.2 Message Semantics

HL7 2.5.1 Chapter 4 OMI message. Refer to HL7 Standard for general message semantics.

The Importer uses an OMI message to convey necessary procedure and scheduling information to the Department System Scheduler/Order Filler.

1485

**Note:** Additional information regarding HL7 conventions, profiling, and implementation considerations is given in RAD TF-2: 2.3.

**The segments listed below are required. All other segments are optional.**

OMI	Imaging Order Message	Chapter in HL7 v2.5.1
MSH	Message Header	2
PID	Patient Identification	3
PV1	Patient Visit	3
{ ROL }	Role	15
{ ORC	Common Order	4
TQ1	Timing / Quantity	4

OMI	Imaging Order Message	Chapter in HL7 v2.5.1
OBR	Order Detail	4
{ IPC }	Imaging Procedure Control	4

1490

Each message shall be acknowledged by the HL7 ACK message sent by the receiver of the OMI message to its sender. See RAD TF-2: 2.4.4.3 “Acknowledgement Modes” for definition and discussion of the ACK message.

#### 4.78.4.1.2.1 MSH Segment

1495 The MSH segment shall be constructed as defined in ITI TF-2b: 3.30.5.1 MSH – Header Segment. Additional specifications for actors complying with the IHE Radiology Technical Framework are in RAD TF-2: 2.4.

1500 Field *MSH-9-Message Type* shall have three components. The first component shall have a value of OMI; the second component shall have a value of O23; the third component shall have a value of OMI\_O23.

#### 4.78.4.1.2.2 PID Segment

All of the fields in the PID segment are optional, except those listed in Table 4.78.4.1.2.2-1.

**Table 4.78.4.1.2.2-1: IHE Profile - PID segment**

SEQ	LEN	DT	OPT	TBL#	ITEM#	ELEMENT NAME
3	250	CX	R		00106	Patient Identifier List
5	250	XPN	C		00108	Patient Name
7	26	TS	CE		00110	Date/Time of Birth
8	1	IS	C	0001	00111	Sex
10	250	CE	CE	0005	00113	Race
11	250	XAD	CE		00114	Patient Address
18	250	CX	E		00121	Patient Account Number

1505

*Adapted from the HL7 standard, version 2.5.1*

1510 Every system participating in the information exchange using HL7 shall use field *PID-3-Patient Identifier List* to convey the Patient ID uniquely identifying the patient, typically the ID assigned by the ADT/Registration System. However, this could also be the master patient index. See RAD TF-2: Appendix B and Appendix D for further discussion of the use of PID-3 in transactions and its mapping from HL7 messages to DICOM Patient ID (0010,0020).

Fields *PID-3-Patient Identifier List*, *PID-5-Patient Name*, *PID-7-Date/Time of Birth*, *PID-8-Sex*, *PID-10-Race*, *PID-11-Patient Address*, and *PID-18 Patient Account Number* shall be valued in the ORI message. They shall not be valued in the OMI message.



1515 **4.78.4.1.2.3 PV1 Segment**

All of the fields in the PV1 segment are optional, except those listed in Table 4.78.4.1.2.3-1.

**Table 4.78.4.1.2.3-1: IHE profile - PV1 Segment**

SEQ	LEN	DT	OPT	TBL#	ITEM#	ELEMENT NAME
2	1	IS	R	0004	00132	Patient Class
3	80	PL	C		00133	Assigned Patient Location
7	60	XCN	C	0010	00137	Attending Doctor
8	60	XCN	C	0010	00138	Referring Doctor
9	60	XCN	X	0010	00139	Consulting Doctor
10	3	IS	C	0069	00140	Hospital Service
15	2	IS	C	0009	00145	Ambulatory Status
17	60	XCN	C	0010	00147	Admitting Doctor
19	20	CX	CE		00149	Visit Number
51	1	IS	C	0326	01226	Visit Indicator

*Adapted from the HL7 standard, version 2.5.1*

1520

Additional requirements for the presence of values in these fields may be documented in regional or national appendices to the IHE Technical Framework (See RAD TF-4).

Fields *PV1-3-Assigned Patient Location*, *PV1-7-Attending Doctor*, *PV1-10-Hospital Service*, *PV1-17-Admitting Doctor* shall be valued only when a procedure is scheduled for an admitted in-patient.

1525

Field *PV1-8-Referring Doctor* shall be valued when registering an outpatient (*MSH-9- Message Type* is ADT^A04^ADT\_A01) or when pre-registering a patient (*MSH-9-Message Type* is ADT^A05^ADT\_A05).

The PV1 segment shall be followed for each of the attending doctor, admitting doctor, and referring doctor, by a ROL segment.

1530

Field *PV1-9-Consulting Doctor* shall not be present. The consulting doctor(s) are required and entirely described in the ROL segments.

Field *PV1-15-Ambulatory Status* shall be valued when patient status indicates certain conditions such as pregnancy. It may be omitted if none of the defined statuses are applicable to a patient.

1535

Field *PV1-51-Visit Indicator* shall be valued with value “V” if the field *PV1-19-Visit Number* is valued. It may be omitted otherwise.

**4.78.4.1.2.4 ROL Segment**

An ROL segment shall be included for each *Consulting Doctor*.

The ROL Segment shall be constructed as defined in ITI TF-2b: 3.30.5.6 ROL- Role Segment.

1540 **4.78.4.1.2.5 ORC Segment**

All of the fields in the ORC segment are optional, except those listed in Table 4.78.4.1.2.5-1. See RAD TF-2: 4.2.4.1.2.2.4 for the list of all fields of the ORC segment.

**Table 4.78.4.1.2.5-1: IHE Profile - ORC Segment**

SEQ	LEN	DT	OPT	TBL#	ITEM #	ELEMENT NAME
1	2	ID	R	0119	00215	Order Control
2	22	EI	CE		00216	Placer Order Number
3	22	EI	C		00217	Filler Order Number
5	2	ID	R	0038	00219	Order Status
7	200	TQ	X		00221	Quantity/Timing
10	250	XCN	RE		00224	Entered By
12	250	XCN	RE		00226	Ordering Provider
13	80	PL	RE		00227	Enterer's Location
14	250	XTN	RE		00228	Call Back Phone Number
17	250	CE	RE		00231	Entering Organization

1545

*Adapted from the HL7 Standard, version 2.5.1*

Fields *ORC-2-Placer Order Number* and *ORC-3-Filler Order Number* shall be valued only in the ORI message and omitted in the OMI message.

The Importer uses the OMI message in a context different from the context existing between Order Placer and Order Filler. The Importer shall send a single OMI message per Study to be imported.

1550

Required fields in the ORC segment shall be filled by the Importer as given in the following table.

**Table 4.78.4.1.2.5-2: DSS Mappings of the ORC Segment**

Element Name	Seq.	Element Shall Contain:	Notes
Order Control Code	ORC-1	"NW"	New order
Placer Order Number	ORC-2	Placer Order Number received from Order Placer	The Order Placer Number always originates from the Order Placer. The DSS/Order Filler has to obtain it from the Order Placer in the ORG message of the Filler Order Management [RAD-3] transaction.
Filler Order Number	ORC-3	Filler Order Number	Number generated internally by the Department System Scheduler

Element Name	Seq.	Element Shall Contain:	Notes
Order Status	ORC-5	“SC”	Scheduled
Quantity/Timing	ORC-7	Shall not be valued: Date and time of the Scheduled Procedure Step shall be carried in the immediately following TQ1 segment.	

1555

#### 4.78.4.1.2.6 TQ1 Segment

Deprecated components ORC-7.4-Start Date/Time or OBR-27.4-Start Date/Time shall not be populated but instead the TQ1 segment shall be used to carry the start date and time of the procedure.

1560

**Table 4.78.4.1.2.6-1: IHE Profile – TQ1 Segment**

SEQ	LEN	DT	OPT	TBL#	ITEM #	ELEMENT NAME
1	4	SI	O		01627	Set ID – TQ1
2	20	CQ	O		01628	Quantity
3	540	RPT	O	0335	01629	Repeat Pattern
4	20	TM	O		01630	Explicit Time
5	20	CQ	O		01631	Relative Time and Units
6	20	CQ	O		01632	Service Duration
7	26	TS	R		01633	Start Date/Time
8	26	TS	O		01634	End Date/Time
9	250	CWE	O	0485	01635	Priority
10	250	TX	O		01636	Condition Text
11	250	TX	O	0065	01637	Text Instruction
12	10	ID	C	0427	01638	Conjunction
13	20	CQ	O		01639	Occurrence Duration
14	10	NM	O		01640	Total Occurrences

*Adapted from the HL7 Standard, version 2.5.1*

Field *TQ1-7-Start Date/Time* shall contain the date and time of the acquired Study as taken from the Study Date (0008,0020) and Study Time (0008,0030) of the imported objects. If the imported objects do not provide these values then the current data and time shall be used.

1565

#### 4.78.4.1.2.7 OBR Segment

All of the fields in the OBR segment are optional, except those listed in Table 4.78.4.1.2.7-1.

**Table 4.78.4.1.2.7-1: IHE Profile - OBR Segment**

SEQ	LEN	DT	OPT	TBL#	ITEM#	ELEMENT NAME
1	4	SI	R		00237	Set ID – OBR
2	22	EI	CE		00216	Placer Order Number
3	22	EI	C		00217	Filler Order Number
4	200	CE	R		00238	Universal Service ID
5	2	ID	RE		00239	Priority
12	60	CE	RE		00246	Danger Code
13	300	ST	RE		00247	Relevant Clinical Info.
16	120	XCN	RE		00226	Ordering Provider
17	40	XTN	RE		00250	Order Callback Phone Number
27	200	TQ	X		00221	Quantity/Timing
30	20	ID	RE	0124	00262	Transportation Mode
31	300	CE	RE		00263	Reason for Study
44	80	CE	RE		00393	Procedure Code
46	250	CE	RE	0411	01474	Placer Supplemental Service Information

1570

*Adapted from the HL7 Standard, version 2.5.1*

One ORC-TQ1-OBR-IPC segment group shall correspond to each Requested Procedure. If a Requested Procedure is comprised of multiple Scheduled Procedure Steps and/or if a Scheduled Procedure Step is comprised of multiple Protocol Codes, each applicable Scheduled Procedure Step / Protocol Code combination shall be included in a separate IPC segment following the ORC-TQ1-OBR segment group that contains the Requested Procedure.

1575

- Fields *ORC-2-Placer Order Number*, and *ORC-3-Filler Order Number*, Components 1-3 of the *ORC-4-Universal Service ID* shall be valued only in the ORI message and omitted in the OMI message.

1580

- Field *OBR-46-Placer Supplemental Service Information* shall contain the laterality (Left/Right) indicator (when applicable). Field *OBR-15-Specimen Source*, which had formerly been adapted for this use by the IHE Technical Framework and has been deprecated in HL7 Version 2.5.1, shall not be present. See RAD TF-2: Appendix B for details.

1585

Per the HL7 Standard, IHE recommends that some fields in the ORC and OBR segments contain the same information, as described in RAD TF-2: 4.2.4.1.2.6.6.

Non-optional fields in the OBR segment that are not identical to those from the ORC segment shall be filled by the Importer as defined in the following table.

1590

**Table 4.78.4.1.2.7-2: DSS mappings of the OBR Segment**

Element Name	Seq.	Shall Contain:	Notes
Universal Service ID	OBR-4	The Universal Service ID of the Order.	Components 1-3 of OBR-4 shall be copied by the Order Filler from the components 1-3 of OBR-4 it obtains from the ORM message (OBR segment) conveyed to it by the Order Placer. Components 1-3 of OBR-4 in all OBR segments of an OMI message shall have the same value. The related Requested Procedure Code/Description are sent in OBR-44.
Procedure Code	OBR-44	Requested Procedure Code and Requested Procedure Description.	Components 1-3 shall contain the Requested Procedure Code for this OMI message. Optionally, component 5 may contain the Requested Procedure Description.
Placer Supplemental Service Information	OBR-46	This element shall be used for the L/R (laterality) indicator, if applicable. The L/R value shall be appended to the Requested Procedure Description (0032,1060).	This element shall only be used if the coding scheme that is employed does not contain laterality within the coding scheme itself. If laterality is inherent in the coding scheme, this element shall not be sent.

**4.78.4.1.2.8 IPC Segment**

All of the fields in the IPC segment are optional, except those listed in Table 4.78.4.1.2.8-1.

1595

**Table 4.78.4.1.2.8-1: IHE Profile –IPC Segment**

SEQ	LEN	DT	OPT	TBL#	ITEM#	ELEMENT NAME
1	80	EI	C		00237	Accession Identifier
2	22	EI	C		00216	Requested Procedure ID
3	70	EI	R		00217	Study Instance UID
4	22	EI	C		00238	Scheduled Procedure Step ID
5	16	CE	R+		00239	Modality
6	250	CE	RE		00246	Protocol Code

*Adapted from the HL7 Standard, version 2.5.1*

As provided by the HL7 Standard, each OMI message shall convey information about Requested Procedure(s) pertaining to one order.

1600

The value of the IPC-1 field shall be identical in all IPC segments. See the HL7 Standard for further explanation of the use of the IPC segment within the OMI message.

- Fields IPC-1 Accession Identifier, IPC-2 Requested Procedure ID, IPC-4 Scheduled Procedure Step ID, and IPC-6 Protocol Code shall be valued only in the ORI message and omitted in the OMI message.
- 1605 • The Importer shall assign Field IPC-3 Study Instance UID the Study Instance UID from the DICOM objects to be imported. The Department System Scheduler/Order Filler shall use this UID rather than creating their own.

#### **4.78.4.1.3 Expected Actions**

- 1610 If the Department System Scheduler/Order Filler accepts and registers order information transmitted from the Importer in the Order Filler Request OMI message then it shall convey the acceptance by returning an ORI (Success) message.

##### **4.78.4.1.3.1 Automated Order Placement and Scheduling Option**

- 1615 If a Department System Scheduler/Order Filler supporting the Automated Order Placement and Scheduling Option receives an Order Filler Request OMI message, then it shall use the received information to trigger the placement of the order on the Order Placer using the Order Filler Order Management [RAD-3] transaction. If a Success response is returned from the Order Placer, then the Department System Scheduler/Order Filler shall convey the acceptance by returning an ORI (Success) message to the Importer. The Department System Scheduler/Order Filler shall return its assigned Filler Order Number plus the Placer Order Number returned by the Order Placer in the ORI (Success) message. The Department System Scheduler/Order Filler shall also convey the newly filled order to the Image Manager/Archive using the Procedure Scheduled [RAD-4] transaction. The Department System Scheduler/Order Filler shall copy any Import Instructions received in the Request Filling of Order transaction to the Scheduled Protocol Code of the Procedure Scheduled [RAD-4] transaction (RAD TF-2: 4.4.4.1.2.1.5.1.1 and 4.4.4.1.2.2.8.1.1).
- 1620
- 1625 If the Department System Scheduler/Order Filler cannot accept order information transmitted from the Importer in the Order Filler Request OMI message or the Order Placer returns an Error message, then it shall convey the rejection to the Importer by returning an ORI (Error) message.

#### **4.78.5 Security Considerations**

##### **4.78.5.1 Security Audit Considerations**

- 1630 The Radiology Audit Trail Option in the IHE ITI Audit Trail and Node Authentication Profile (ITI TF-1:9) defines audit requirements for IHE Radiology transactions. See RAD TF-3:5.

*Add TF vol 3, Section 4.79 Import Instructions Request to support the IRWF.b Import Instruction Handling Option.*

1635 **4.79 Import Instructions Request**

This section corresponds to Transaction RAD-79 of the IHE Technical Framework. Transaction RAD-79 is used by the Importer and Image Manager/Archive actors.

**4.79.1 Scope**

1640 This transaction is used by the Importer to send Import Instructions directly to an Image Manager/Archive in an order message. Once the order message has been sent, the Importer cannot change or cancel it.

**4.79.2 Use Case Roles**

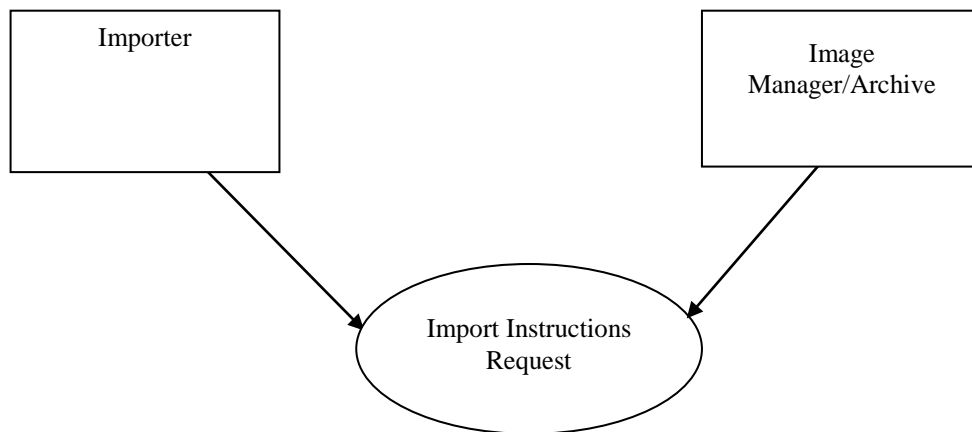

**Actor:** Importer

1645 **Role:** Sends an order with import instructions to the Image Manager/Archive.

**Actor:** Image Manager/Archive

**Role:** Receives and processes instructions requests.

**4.79.3 Referenced Standards**

HL7 2.5.1 Chapter 4

1650 **4.79.4 Interaction Diagram**

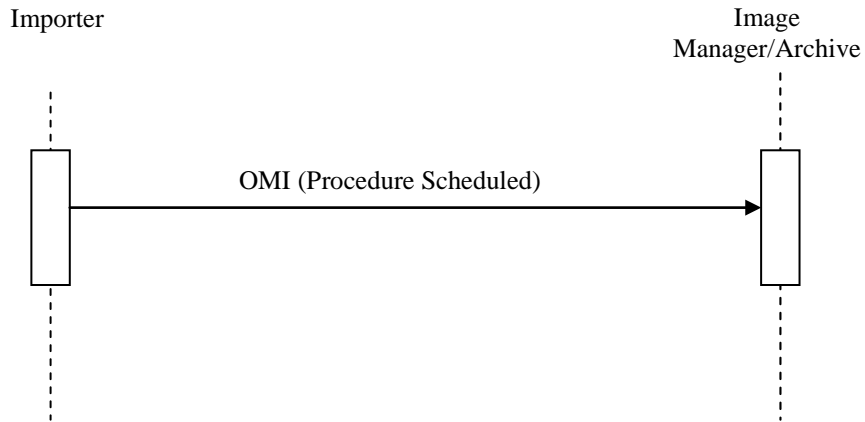

**4.79.4.1 Order Management – Import Instructions from Importer**

**4.79.4.1.1 Trigger Events**

1655 The Importer determines the import instructions which need to be performed for the imported Study and sends these in an order message to the Image Manager/Archive.

**4.79.4.1.2 Message Semantics**

HL7 2.5.1 Chapter 4 OMI message. Refer to HL7 Standard for general message semantics.

1660 The Importer uses an OMI message to convey necessary import instructions to the Image Manager/Archive. The Importer uses the OMI message in a context different from the context existing between Order Placer and Order Filler. The Importer shall send a single OMI message per Study to be imported.

Note: Additional information regarding HL7 conventions, profiling, and implementation considerations is given in RAD TF-2: 2.3.

The segments listed below are required. All other segments are optional.

1665

OMI	Imaging Order Message	Chapter in HL7 v2.5.1
MSH	Message Header	2
PID	Patient Identification	3
PV1	Patient Visit	3
{ ROL }	Role	15
{ ORC	Common Order	4
TQ1	Timing / Quantity	4
OBR	Order Detail	4



OMI	Imaging Order Message	Chapter in HL7 v2.5.1
{ IPC }	Imaging Procedure Control	4

Each message shall be acknowledged by the HL7 ACK message sent by the receiver of the OMI message to its sender. See RAD TF-2: 2.4.4.3 “Acknowledgement Modes” for definition and discussion of the ACK message.

1670 **4.79.4.1.2.1 MSH Segment**

The MSH segment shall be constructed as defined in ITI TF-2b: 3.30.5.1 MSH – Header Segment. Additional specifications for actors complying with the IHE Radiology Technical Framework are in RAD TF-2: 2.4.

1675 Field *MSH-9-Message Type* shall have three components. The first component shall have a value of OMI; the second component shall have a value of O23; the third component shall have a value of OMI\_O23.

**4.79.4.1.2.2 PID Segment**

All of the fields in the PID segment are optional, except those listed in Table 4.79.4.1.2.2-1. See RAD TF-2: 4.1.4.1.2.2.3 for further discussion of the PID segment.

1680

**Table 4.79.4.1.2.2-1: IHE Profile - PID segment**

SEQ	LEN	DT	OPT	TBL#	ITEM#	ELEMENT NAME
3	250	CX	R		00106	Patient Identifier List
5	250	XPN	R		00108	Patient Name
7	26	TS	RE		00110	Date/Time of Birth
8	1	IS	R	0001	00111	Sex
10	250	CE	RE	0005	00113	Race
11	250	XAD	RE		00114	Patient Address
18	250	CX	C		00121	Patient Account Number

*Adapted from the HL7 standard, version 2.5.1*

1685 Every system participating in the information exchange using HL7 shall use field *PID-3-Patient Identifier List* to convey the Patient ID uniquely identifying the patient, typically the ID assigned by the ADT/Registration System. However, this could also be the master patient index. See RAD TF-2: Appendix B and RAD TF-2: Appendix D for further discussion of the use of PID-3 in transactions and its mapping from HL7 messages to DICOM Patient ID (0010,0020).

1690 Fields *PID-3-Patient Identifier List*, *PID-5-Patient Name*, *PID-7-Date/Time of Birth*, *PID-8-Sex*, *PID-10-Race*, and *PID-11-Patient Address* shall be set to the values determined using the PIX Query [ITI-9], Patient Demographic Query [ITI-21], or Query for Patient ID [RAD-77]

transactions. If a corresponding value is not determined then the value shall be left blank in the OMI message.

**4.79.4.1.2.3 PV1 Segment**

1695 All of the fields in the PV1 segment are optional.

**4.79.4.1.2.5 ORC Segment**

All of the fields in the ORC segment are optional, except those listed in Table 4.79.4.1.2.5-1. See RAD TF-2: 4.2.4.1.2.2.4 for the list of all fields of the ORC segment.

1700

**Table 4.79.4.1.2.5-1: IHE Profile - ORC Segment**

SEQ	LEN	DT	OPT	TBL#	ITEM #	ELEMENT NAME
1	2	ID	R	0119	00215	Order Control
2	22	EI	RE		00216	Placer Order Number
3	22	EI	RE		00217	Filler Order Number
5	2	ID	R	0038	00219	Order Status
7	200	TQ	X		00221	Quantity/Timing
10	250	XCN	RE		00224	Entered By
12	250	XCN	RE		00226	Ordering Provider
13	80	PL	RE		00227	Enterer's Location
14	250	XTN	RE		00228	Call Back Phone Number
17	250	CE	RE		00231	Entering Organization

*Adapted from the HL7 Standard, version 2.5.1*

Required fields in the ORC segment shall be filled by the Importer as given in the following table.

1705

**Table 4.79.4.1.2.5-2: DSS Mappings of the ORC Segment**

Element Name	Seq.	Element Shall Contain:	Notes
Order Control Code	ORC-1	“NW”	New order
Placer Order Number	ORC-2	Placer Order Number received from Order Placer	This field shall be empty
Filler Order Number	ORC-3	Filler Order Number	This field shall be empty
Order Status	ORC-5	“SC”	Scheduled
Quantity/Timing	ORC-7	Shall not be valued: Date and time of the Scheduled Procedure Step shall be carried in the immediately following TQ1 segment.	

**4.79.4.1.2.6 TQ1 Segment**

1710 Deprecated components ORC-7.4-Start Date/Time or OBR-27.4-Start Date/Time shall not be populated but instead the TQ1 segment shall be used to carry the start date and time of the procedure.

**Table 4.79.4.1.2.6-1: IHE Profile – TQ1 Segment**

SEQ	LEN	DT	OPT	TBL#	ITEM #	ELEMENT NAME
1	4	SI	O		01627	Set ID – TQ1
2	20	CQ	O		01628	Quantity
3	540	RPT	O	0335	01629	Repeat Pattern
4	20	TM	O		01630	Explicit Time
5	20	CQ	O		01631	Relative Time and Units
6	20	CQ	O		01632	Service Duration
7	26	TS	RE		01633	Start Date/Time
8	26	TS	O		01634	End Date/Time
9	250	CWE	O	0485	01635	Priority
10	250	TX	O		01636	Condition Text
11	250	TX	O	0065	01637	Text Instruction
12	10	ID	C	0427	01638	Conjunction
13	20	CQ	O		01639	Occurrence Duration
14	10	NM	O		01640	Total Occurrences

*Adapted from the HL7 Standard, version 2.5.1*

1715

Field *TQ1-7-Start Date/Time* shall contain the date and time of the exam, taken from attributes Study Date (0008,0020) and Study Time (0008,0030) of the imported objects. If no values are provided then the no value shall be sent.

**4.79.4.1.2.7 OBR Segment**

1720 All of the fields in the OBR segment are optional, except those listed in Table 4.79.4.1.2.7-1. See RAD TF-2: 4.2.4.1.2.2.6 for the list of all fields of the OBR segment.

**Table 4.79.4.1.2.7-1: IHE Profile - OBR Segment**

SEQ	LEN	DT	OPT	TBL#	ITEM#	ELEMENT NAME
1	4	SI	R		00237	Set ID – OBR
2	22	EI	RE		00216	Placer Order Number
3	22	EI	RE		00217	Filler Order Number
4	200	CE	RE		00238	Universal Service ID

SEQ	LEN	DT	OPT	TBL#	ITEM#	ELEMENT NAME
5	2	ID	RE		00239	Priority
12	60	CE	RE		00246	Danger Code
13	300	ST	RE		00247	Relevant Clinical Info.
16	120	XCN	RE		00226	Ordering Provider
17	40	XTN	RE		00250	Order Callback Phone Number
27	200	TQ	X		00221	Quantity/Timing
30	20	ID	RE	0124	00262	Transportation Mode
31	300	CE	RE		00263	Reason for Study
44	80	CE	RE		00393	Procedure Code
46	250	CE	RE	0411	01474	Placer Supplemental Service Information

*Adapted from the HL7 Standard, version 2.5.1*

1725 One ORC-TQ1-OBR-IPC segment group shall correspond to each Requested Procedure. If a Requested Procedure is comprised of multiple Scheduled Procedure Steps and/or if a Scheduled Procedure Step is comprised of multiple Protocol Codes, each applicable Scheduled Procedure Step / Protocol Code combination shall be included in a separate IPC segment following the ORC-TQ1-OBR segment group that contains the Requested Procedure.

1730

- Field OBR-46-Placer Supplemental Service Information shall contain the laterality (Left/Right) indicator (when applicable). Field OBR-15-Specimen Source, which had formerly been adapted for this use by the IHE Technical Framework and has been deprecated in HL7 Version 2.5.1, shall not be present. See RAD TF-2: Appendix B for details.

1735

- Per the HL7 Standard, IHE recommends that some fields in the ORC and OBR segments contain the same information, as described in RAD TF-2: 4.2.4.1.2.6.6.

Non-optional fields in the OBR segment that are not identical to those from the ORC segment shall be filled by the Importer as defined in the following table.

1740

**Table 4.79.4.1.2.7-2: DSS mappings of the OBR Segment**

Element Name	Seq.	Shall Contain:	Notes
Procedure Code	OBR-44	Requested Procedure Code and Requested Procedure Description.	Components 1-3 shall contain the Requested Procedure Code for this OMI message. Optionally, component 5 may contain the Requested Procedure Description.
Placer Supplemental Service Information	OBR-46	This element shall be used for the L/R (laterality) indicator, if applicable. The L/R value shall be appended to the Requested Procedure Description (0032,1060).	This element shall only be used if the coding scheme that is employed does not contain laterality within the coding scheme itself. If laterality is inherent in the coding scheme, this element shall not be sent.

**4.79.4.1.2.8 IPC Segment**

1745 All of the fields in the IPC segment are optional, except those listed in Table 4.79.4.1.2.8-1.

**Table 4.79.4.1.2.8-1: IHE Profile – IPC Segment**

SEQ	LEN	DT	OPT	TBL#	ITEM#	ELEMENT NAME
1	80	EI	RE		00237	Accession Identifier
2	22	EI	RE		00216	Requested Procedure ID
3	70	EI	R		00217	Study Instance UID
4	22	EI	RE		00238	Scheduled Procedure Step ID
5	16	CE	R+		00239	Modality
6	250	CE	R		00246	Protocol Code

*Adapted from the HL7 Standard, version 2.5.1*

1750 The Importer uses the OMI message in a context different from the context of the ORM message sent between the Order Placer and Order Filler. As provided by the HL7 Standard, each OMI message shall convey information about Requested Procedure(s) pertaining to one order.

The value of the IPC-1 field shall be identical in all IPC segments. See the HL7 Standard for further explanation of the use of the IPC segment within the OMI message.

- 1755
- The Importer shall assign Field IPC-3 Study Instance UID the Study Instance UID from the DICOM objects to be imported.
  - The Importer shall assign Field IPC-6 Protocol Code with the Import Instruction Codes (RAD TF-2: Table 4.5-4). It shall always contain at least one value with code (IRWF001, IHETFRAD, “Import”).

- 1760
- The Importer supporting the Import Instruction Handling Option shall support the following methods for setting Import Instructions for the Unscheduled Import method:
    - RAD TF-3: K.2.2.1 Importer Configurable Import Instruction Code Mapping for Objects Received Over the Network

#### **4.79.4.1.3 Expected Actions**

- 1765 The Image Manager/Archive accepts and registers order information transmitted from the Importer in the Order Filler Request OMI message.

##### **4.79.4.1.3.1 Import Instruction Handling Option**

The Image Manager/Archive supporting the Import Instruction Handling Option shall support the handling of Import Instruction Codes as specified in:

- 1770
- RAD TF-3: K.3.1: Image Manager Import Instruction Code Handling

*Modify TF Vol 2, Appendix A.5: Import Object Integration – Critical Attributes to include specifications for mapping of attributes for the new options.*

1775 **A.5 Imported Object Integration – Critical Attributes**

The Importer shall modify each DICOM object to ensure that critical attributes from the local Enterprise are incorporated.

1780 The tables below describe requirements, recommendations or explanations on integration-critical attributes for cases covering import of digital media and creation of digitized objects into the local environment.

Until such time that Code Sets are consistent among Enterprises, the Protocol Code Sets used within one Enterprise will most likely not be valid in another Enterprise. Coercion rules or mechanisms for Code Sets are out of scope for the Radiology Technical Framework.

**General table structure:**

- 1785
- The 1st column denotes the DICOM attributes whose values shall be mapped between the DICOM objects (equal values in the same table row). The DICOM attribute tag is indicated for clarity.
  - The 2nd to 5th columns define where attribute values come from: all defined attribute values of one table row are equal. These columns read left to right.
- 1790
- The column labeled ‘Objects for Import’ refers to attributes and values included in, or “extracted” from the objects to be imported. In the case of hardcopy import (i.e., digitization), this extraction can be done via OCR or manual entry, extracted from the paperwork accompanying the media, or via some other mechanism. It is likely that values will not be available for some of the attributes in that column.
- 1795
- The column labeled ‘Resultant IOD’ signifies the attributes and values included in the objects resulting from the Import action (regardless of the source of the import).
  - The MWL column is replaced by a column entitled ‘Demographic Query Information’ for unscheduled cases where the Importer receives information via an HL7 query message rather than via a DICOM MWL response.

1800 **Cell content conventions:**

- “Source” in a table cell means that the DICOM object defined in the table column (e.g., MWL) and created by one actor shall be the source of this value for the DICOM attribute for another actor to fill in this value for their own objects (e.g., Image or MPPS).
  - “Copy” in a table cell means that the value shall be copied from a corresponding source attribute of another DICOM object, as defined by the table column.
  - ”Copy from: <DICOM attribute>” means that, instead of using the DICOM attribute of the same row as the source, the source as specified in the referenced DICOM attribute shall be used.
- 1805

- 1810 • “Equal” in a table cell means that an actor already knows the value, e.g., from some previously performed action. Thus, the circumstances of value generation do not matter.
- “Equal (internally generated)” in a table cell means that an actor has internally generated a value that may be used in more than one DICOM object, without having obtained this value from another actor (i.e., no copy).
- 1815 • ”Source-1”, “Copy-1” or “Equal-1” etc. are corresponding mapping attribute values, if several sources appear in one table row.
- “Copy-2 [Copy-1]” in a table cell means Copy the value from Source-2 (Copy-2) if present, otherwise Copy from Source-1 (Copy-1).
- 1820 • “Merge Copy-1, Copy-2” in a table cell means that the values copied from multiple sources are all to be included in the resulting attribute. Note: this is done only for some multi-valued or sequence attributes.
- “See (IHE-X)” in a table cell denotes additional requirements, recommendations or explanations for the attribute value, as described in the table’s note “(IHE-X)”. Otherwise, brief text that fits into a table cell is presented in the cell.
- 1825 • “n.a.” in a table cell means that such an attribute or value shall not exist. Either the attribute is not defined by the DICOM standard for this object, or the particular sequence attribute is a DICOM type 3 attribute, and DICOM requires at least one sequence item to be present.

**Actor behavior:**

- 1830 • The general goal for the ‘importing’ actor (Importer) is to minimally change the original Objects. Only attributes that are critical to ensure identification consistency in the receiving environment are coerced.
- The ‘importing’ actor (Importer) shall use the values in the second and third columns (‘Objects for Import’ and ‘MWL return values’ or ‘Demographic Query Information’) as the source for copying into the Image/ Standalone or MPPS IODs according to the rules defined within the tables.
- 1835 • The ‘importing’ actor (Importer) shall not assume that instances on the media are from the same Series, Study, Patient, etc. There are cases where the media may contain multiple patients.
- 1840 • Any attribute value in the original Objects for Import that is replaced by the importing actor shall be recorded in the ‘Original Attributes Sequence’ contained in the Objects resulting from the import activity.
- Attributes from the column “Modality Worklist” shall be requested by a MWL SCU (Importer) as a return key in its C-FIND Requests. The Department System Scheduler



- 1845 shall return attribute values in the Modality Worklist C-FIND response (for a complete description, see Table 4.5-3).
- The PPS Manager, Image Manager and Department System Scheduler actors shall be capable of handling the attributes shown in the column titled “MPPS IOD” as defined by the SCP Type and the additional notes. The general goal is to use the PPS information presenting for the imported instances for use in the resulting PPS.
- 1850

**Table A.5-1: Scheduled Import - Required Mapping of Corresponding Attributes**

DICOM attribute	Objects for Import	Modality Worklist (return attribute values)	Filling values for:		
			Resultant IOD	MPPS IOD	
Patient Name (0010,0010)	Source-1	Source-2	Copy-2 [Copy-1]	Copy-2 [Copy-1]	
Patient ID (0010,0020)	Source-1	Source-2	Copy-2 [ <del>Copy-1</del> ]	Copy-2 [ <del>Copy-1</del> ]	
<b><u>Issuer of Patient ID (0010,0021)</u></b>	<b><u>Source-1</u></b>	<b><u>Source-2</u></b>	<b><u>Copy-2</u></b>	<b><u>Copy-2</u></b>	
Other Patient Ids (0010,1000)	Source-1	Source-2	<u>n.a</u> (See IHE-A.5.1.11)	<u>n.a</u>	
<b><u>Other Patient IDs Sequence (0010,1002)</u></b>	<b><u>Source-1</u></b>	<b><u>Source-2</u></b>	<b><u>Merge Copy-1,Copy-2</u></b>	<u>n.a</u>	
Patient’s Birth Date (0010,0030)	Source-1	Source-2	Copy-2 [Copy-1]	Copy-2 [Copy-1]	
Patient’s Sex (0010,0040)	Source-1	Source-2	Copy-2 [Copy-1]	Copy-2 [Copy-1]	
Study Instance UID (0020,000D)	Source-1 (See IHE-A.5.1.2)	Source-2	Copy-1 [Copy-2] (See IHE-A.5.1.2)	Scheduled Step Attributes Sequence (0040,0270)	
Referenced Study Sequence (0008,1110)	Source-1 See (IHE-A.5.1.8)	Source-2 See (IHE-A.5.1.6)	Copy-1 [Copy-2]		Copy-1 [Copy-2]
Accession number (0008,0050)	Source-1	Source-2	Copy-2 See (IHE- A.5.1.3)		Copy-2 See (IHE-A.5.1.3)
<b><u>Issuer of Accession Number Sequence (0008,0051)</u></b>	<b><u>Source-1</u></b>	<b><u>Source-2</u></b>	<b><u>Copy-2 or Empty</u></b>		<b><u>Copy-2 or Empty</u></b>
Requested Procedure ID (0040,1001)	Source-1	Source-2	Request Attributes Sequence (0040,0275)		Copy-2 [Copy-1]
Requested Procedure Description (0032,1060)	Source-1	Source-2		Copy-2 [Copy-1] See (IHE-A.5.1.7)	Copy-2 [Copy-1] See (IHE-A.5.1.7)

IHE Radiology Technical Framework Supplement – Import Reconciliation Workflow (IRWF.b)

DICOM attribute	Objects for Import	Modality Worklist (return attribute values)	Filling values for:			
			Resultant IOD	MPPS IOD		
Scheduled Procedure Step ID (0040,0009)	Source-1	Source-2	Copy-2 [Copy-1]	Copy-2 [Copy-1]		
Scheduled Procedure Step Description (0040,0007)	Source-1	Source-2			Copy-1	Copy-2
Scheduled Protocol Code Sequence (0040,0008)	Source-1	Source-2			Copy-1 See (IHE-A.5.1.7)	Copy-2
Performed Protocol Code Sequence (0040,0260)	Source-1	n.a.	Copy-1 See (IHE-A.5.1.9)	See (IHE-A.5.1.10)		
Study ID (0020,0010)	Source	n.a.	Copy [Equal (Internally Generated Recommendation: Use Requested Procedure ID from MWL)]	Copy [Equal (Internally Generated Recommendation: Use Requested Procedure ID from MWL)]		
Performed Procedure Step ID (0040,0253)	Source See (IHE-A.5.1.1)	n.a.	Copy See (IHE-A.5.1.1)	Copy [Equal (Internally Generated)] See (IHE-A.5.1.1)		
Performed Procedure Step Description (0040,0254)	Source	n.a.	Copy See (IHE-A.5.1.7)	Copy See (IHE-A.5.1.7)		
Performed Procedure Step Start Date (0040,0244)	Source	n.a.	Copy	Equal (internally generated).		
Performed Procedure Step Start Time (0040,0245)	Source	n.a.	Copy	Equal (internally generated).		
Requested Procedure Code Sequence (0032,1064)	n.a.	Value shall be used for Procedure Code Sequence as specified below.	n.a.	n.a.		
Procedure Code Sequence (0008,1032)	n.a.	n.a.	Copy from: Requested Procedure Code Sequence (0032,1064). See (IHE-A.5.1.7)	Copy from: Requested Procedure Code Sequence (0032,1064) See (IHE-A.5.1.7)		

DICOM attribute	Objects for Import	Modality Worklist (return attribute values)	Filling values for:		
			Resultant IOD	MPPS IOD	
Referenced SOP Class UID (0008,1150)	n.a.	n.a.	Referenced PPS Sequence (IHE-A.1.3)	1.2.840.1008.3.1.2.3.3	1.2.840.1008.3.1.2.3.3 See (IHE-A.5.1.4)
Referenced SOP Instance UID (0008,1155)	n.a.	n.a.		Equal to SOP Instance UID of the associated MPPS See (IHE-A.5.1.5)	Equal (internally generated) See (IHE-A.5.1.5)

1855 (IHE-A.5-1.1) Performed Procedure Step ID may be generated by the Importer arbitrarily and is not necessarily unique: Two different Performed Procedure Steps may share the same ID (e.g., may have been generated by different importers). The Performed Procedure Step ID (0040,0253) will not be available when data is imported from non-digital media (e.g., digitized hardcopy objects)

1860 (IHE-A.5-1.2) Valid DICOM UIDs are universally unique, so there should be no risk of collision with local UIDs. When a valid set of DICOM UIDs is present the **Importer** shall use this set and not change them. If the importer detects incorrect UIDs or an inconsistent set of UIDs, then it may correct or re-generate UIDs. The UIDs are used as references between objects, and if they are altered, the Importer shall maintain referential integrity.

1865 (IHE-A.5-1.3) A Zero Length Accession Number shall be created when no reliable value for this attribute is available. Reliable values are those that can be conveyed by means other than manual data entry such as a value received from the Order Filler via a Modality Worklist including an Accession Number or received through a bar code reader.

1870 (IHE-A.5-1.4) In MPPS, SOP Class UID is sent in the Affected SOP Class UID (0000,0002) for the PPS N-Create message and in Requested SOP Class UID (0000,0003) for the PPS N-Set message. SOP Class UID (0008,0016) shall not be used.

(IHE-A.5-1.5) In MPPS, SOP Instance UID is sent in the Affected SOP Instance UID (0000,1000) of the PPS N-Create message and in Requested SOP Instance UID

- 1875 (0000,1001) for the PPS N-Set message. SOP Instance UID (0008,0018) shall not be used.
- (IHE-A.5-1.6) According to the Query Modality Worklist transaction (RAD TF-2: 4.5.4.1.2.2), the DSS/ Order Filler is required to replicate the Study Instance UID value in both the Study Instance UID attribute (0020,000D) and within the
- 1880 Referenced Study Sequence (0008,1110).
- (IHE-A.5-1.7) Descriptions and Codes used in the Enterprise may not match those used in the Evidence Objects. The method used to coerce the Descriptions or Codes is out of scope of the Technical Framework. Note that the Descriptions and Codes from the Evidence Objects may be useful.
- 1885 (IHE-A.5-1.8) The Referenced Study Sequence (0008,1110) will not be available when data is imported from non-digital media (e.g., digitized hardcopy objects)
- (IHE-A.5-1.9) Performed Protocol Codes used in the Enterprise may not match those used in the Evidence Objects. Determination of whether to copy, coerce or remove the Codes is out of scope of the Technical Framework. Note that the Codes from the Evidence
- 1890 Objects may be useful.
- (IHE-A.5-1.10) See Section RAD TF-4.59.4.1.2.3. If no information about the Scheduled Import exists, this shall be internally generated and included as one of the items in the Performed Protocol Sequence. The Performed Protocol Codes present in the Objects for Import may not match those used in the Evidence Objects. Determination of
- 1895 whether to merge, coerce and merge or ~~discard~~discard the Codes is out of scope of the Technical Framework. Note that the Codes from the Evidence Objects may be useful.
- (IHE-A.5-1.11) Other Patient IDs (0010,1000) shall not be included in the imported objects or MPPS message. It is redundant with Other Patient IDs Sequence (0010,1002) and insufficient as it does not allow the Assigning Authority to be conveyed for each Patient ID.**
- 1900

**Table A.5-2: Unscheduled Import - required mapping of corresponding attributes**

DICOM attribute	Objects for Import	Demographic Query Information (return attribute values)	Filling values for:	
			Resultant IOD	MPPS IOD
Patient Name (0010,0010)	Source-1	Source-2 PID:5	Copy-2 [Copy-1]	Copy-2 [Copy-1]
Patient ID (0010,0020)	Source-1	Source-2 PID:3	Copy-2 [Copy-1]	Copy-2 [Copy-1]
Other Patient Ids (0010,1000)	Source-1	Source-2 PID:4	Merge Copy-1, Copy-2	na

DICOM attribute	Objects for Import	Demographic Query Information (return attribute values)	Filling values for:	
			Resultant IOD	MPPS IOD
Patient's Birth Date (0010,0030)	Source-1	Source-2 PID:7	Copy-2 {Copy-1}	
Patient's Sex (0010,0040)	Source-1	Source-2 PID:8	Copy-2 {Copy-1}	
Study Instance UID (0020,000D)	Source (See IHE-A.5.2.6)	n.a	Copy or Equal (internally generated) (See IHE-A.5.2.6)	
Accession number (0008,0050)	Source	n.a	Shall be empty (zero length).	
Requested Procedure ID (0040,1001)	Source	n.a	Request Attributes Sequence (0040,0275)	Equal (internally generated)
Scheduled Procedure Step ID (0040,0009)	Source	n.a		Copy
Scheduled Protocol Code Sequence (0040,0008)	Source	n.a		Copy
Performed Protocol Code Sequence (0040,0260)	Source	n.a	Copy See (IHE-A.5.2.7)	Merge Copy (internally generated). Shall contain a code indicating that an import was performed See (IHE-A.5.2.8)
Study ID (0020,0010)	Source	n.a.	Copy {Equal (Internally Generated)}	Copy {Equal (Internally Generated)}
Performed Procedure Step ID (0040,0253)	Source	n.a.	Copy See (IHE-A.5.2.1)	Copy {Equal (Internally Generated)} See (IHE-A.5.2.1)
Performed Procedure Step Description (0040,0254)	Source	n.a.	Copy See (IHE-A.5.2.5)	Copy See (IHE-A.5.2.5)
Performed Procedure Step Start Date (0040,0244)	Source	n.a	Copy	Equal (internally generated).
Performed Procedure Step Start Time (0040,0245)	Source	n.a	Copy	Equal (internally generated).

DICOM attribute	Objects for Import	Demographic Query Information (return attribute values)	Filling values for:	
			Resultant IOD	MPPS IOD
Requested Procedure Code Sequence (0032,1064)	n.a.	Value shall be used for Procedure Code Sequence as specified below.	n.a.	n.a.
Procedure Code Sequence (0008,1032)	n.a.	n.a.	Copy from: Requested Procedure Code Sequence (0032,1064). See (IHE-A.5.2.5)	Copy from: Requested Procedure Code Sequence (0032,1064) See (IHE-A.5.2.5)
Referenced SOP Class UID (0008,1150)	n.a.	n.a.	Referenced PPS Sequence (IHE-A.2.2.2)	1.2.840.10008.3.1.2.3.3 See (IHE-A.5.2.3)
Referenced SOP Instance UID (0008,1155)	n.a.	n.a.		Equal to SOP Instance UID of the associated MPPS See (IHE-A.5.2.4)

1905

DICOM attribute	Objects for Import	Query for Study	PIX Query	PDQ Query	Query for Patient ID	Filling values for:	
						Resultant IOD	MPPS IOD
<u>Patient Name</u> (0010,0010)	<u>Source-1</u>	<u>Source-2</u>	n.a.	<u>Source-3</u> <u>PID:5</u>	<u>Source-4</u>	<u>Copy-2</u> [ <u>Copy-3</u> ] [ <u>Copy-4</u> ] [ <u>Copy-1</u> ]	<u>Copy-2</u> [ <u>Copy-3</u> ] [ <u>Copy-4</u> ] [ <u>Copy-1</u> ]
<u>Patient ID</u> (0010,0020)	<u>Source-1</u>	<u>Source-2</u>	<u>Source-3</u> <u>PID:3</u>	<u>Source-4</u> <u>PID:3</u>	<u>Source-5</u>	<u>Copy-2</u> [ <u>Copy-3</u> ] [ <u>Copy-4</u> ] [ <u>Copy-5</u> ]	<u>Copy-2</u> [ <u>Copy-3</u> ] [ <u>Copy-4</u> ] [ <u>Copy-5</u> ]
<u>Issuer of Patient ID</u> (0010,0021)	<u>Source-1</u>	<u>Source-2</u>	<u>Source-3</u> <u>PID:3</u>	<u>Source-4</u> <u>PID:3</u>	<u>Source-5</u>	<u>Copy-2</u> [ <u>Copy-3</u> ] [ <u>Copy-4</u> ] [ <u>Copy-5</u> ]	<u>Copy-2</u> [ <u>Copy-3</u> ] [ <u>Copy-4</u> ] [ <u>Copy-5</u> ]
<u>Other Patient Ids</u> (0010,1000)	<u>Source</u>	n.a.	n.a.	n.a.	n.a.	n.a. (See IHE-A.5.2.9)	n.a.
<u>Other Patient IDs Sequence</u> (0010,1002)	<u>Source-1</u>	n.a.	<u>Source-2</u> <u>PID:3</u>	<u>Source-3</u> <u>PID:3</u>	n.a.	<u>Merge Copy-1, Copy-2, Copy-3</u>	n.a.

DICOM attribute	Objects for Import	Query for Study	PIX Query	PDQ Query	Query for Patient ID	Filling values for:	
						Resultant IOD	MPPS IOD
<u>Patient's Birth Date</u> (0010,0030)	<u>Source-1</u>	<u>Source-2</u>	<u>n.a</u>	<u>Source-3</u> <u>PID:7</u>	<u>Source-4</u>	<u>Copv-2 [Copv-3]</u> <u>[Copv-4] [Copv-1]</u>	<u>Copv-2 [Copv-3]</u> <u>[Copv-4] [Copv-1]</u>
<u>Patient's Sex</u> (0010,0040)	<u>Source-1</u>	<u>Source-2</u>	<u>n.a</u>	<u>Source-3</u> <u>PID:8</u>	<u>Source-4</u>	<u>Copv-2 [Copv-3]</u> <u>[Copv-4] [Copv-1]</u>	<u>Copv-2 [Copv-3]</u> <u>[Copv-4] [Copv-1]</u>
<u>Study Instance UID</u> (0020,000D)	<u>Source</u> <u>(See IHE-A.5.2.6)</u>	<u>n.a</u> <u>(Copv used as key for query)</u>	<u>n.a</u>	<u>n.a</u>	<u>n.a</u>	<u>Copv or Equal (internally generated)</u> <u>(See IHE-A.5.2.6)</u>	<u>Copv or Equal (internally generated)</u> <u>(See IHE-A.5.2.6)</u>
<u>Accession number</u> (0008,0050)	<u>Source-1</u>	<u>Source-2</u>	<u>n.a</u>	<u>n.a</u>	<u>n.a</u>	<u>Copv-2 or Empty</u>	<u>Copv-2 or Empty</u>
<u>Issuer of Accession Number Sequence</u> (0008,0051)	<u>Source-1</u>	<u>Source-2</u>	<u>n.a</u>	<u>n.a</u>	<u>n.a</u>	<u>Copv-2 or Empty</u>	<u>Copv-2 or Empty</u>
<u>Requested Procedure ID</u> (0040,1001)	<u>Source</u>	<u>n.a</u>	<u>n.a</u>	<u>n.a</u>	<u>n.a</u>	<u>Equal (internally generated)</u>	<u>Equal (internally generated)</u>
<u>Scheduled Procedure Step ID</u> (0040,0009)	<u>Source</u>	<u>n.a</u>	<u>n.a</u>	<u>n.a</u>	<u>n.a</u>	<u>Copv</u>	<u>Copv [Equal (internally generated)]</u>
<u>Scheduled Protocol Code Sequence</u> (0040,0008)	<u>Source</u>	<u>n.a</u>	<u>n.a</u>	<u>n.a</u>	<u>n.a</u>	<u>Copv</u>	<u>Copv</u>
<u>Performed Protocol Code Sequence</u> (0040,0260)	<u>Source</u>	<u>n.a</u>	<u>n.a</u>	<u>n.a</u>	<u>n.a</u>	<u>Copv</u> <u>See (IHE-A.5.2.7)</u>	<u>Merge Copv (internally generated).</u> <u>Shall contain a code indicating that an import was performed</u> <u>See (IHE A.5.2.8)</u>
<u>Study ID</u> (0020,0010)	<u>Source-1</u>	<u>Source-2</u>	<u>n.a</u>	<u>n.a</u>	<u>n.a</u>	<u>Copv-2 [Copv-1] [Equal (Internally Generated)]</u>	<u>Copv-2 [Copv-1] [Equal (Internally Generated)]</u>
<u>Performed</u>	<u>Source</u>	<u>n.a</u>	<u>n.a</u>	<u>n.a</u>	<u>n.a</u>	<u>Copv</u>	<u>Copv [Equal</u>

DICOM attribute	Objects for Import	Query for Study	PIX Query	PDQ Query	Query for Patient ID	Filling values for:	
						Resultant IOD	MPPS IOD
<u>Procedure Step ID</u> (0040,0253)						See (IHE-A.5.2.1)	(Internally Generated) See (IHE-A.5.2.1)
<u>Performed Procedure Step Description</u> (0040,0254)	<u>Source</u>	<u>n.a.</u>	<u>n.a.</u>	<u>n.a.</u>	<u>n.a.</u>	<u>Copy</u> See (IHE-A.5.2.5)	<u>Copy</u> See (IHE-A.5.2.5)
<u>Performed Procedure Step Start Date</u> (0040,0244)	<u>Source</u>	<u>n.a.</u>	<u>n.a.</u>	<u>n.a.</u>	<u>n.a.</u>	<u>Copy</u>	<u>Equal (internally generated).</u>
<u>Performed Procedure Step Start Time</u> (0040,0245)	<u>Source</u>	<u>n.a.</u>	<u>n.a.</u>	<u>n.a.</u>	<u>n.a.</u>	<u>Copy</u>	<u>Equal (internally generated).</u>
<u>Requested Procedure Code Sequence</u> (0032,1064)	<u>n.a.</u>	<u>n.a.</u>	<u>n.a.</u>	<u>n.a.</u>	<u>n.a.</u>	<u>n.a.</u>	<u>n.a.</u>
<u>Procedure Code Sequence</u> (0008,1032)	<u>Source-1</u>	<u>Source-2</u>	<u>n.a.</u>	<u>n.a.</u>	<u>n.a.</u>	<u>Copy-2 [Copy-1]</u> See (IHE-A.5.2.5)	<u>Copy-2 [Copy-1]</u> See (IHE-A.5.2.5)
<u>Referenced SOP Class UID</u> (0008,1150)	<u>n.a.</u>	<u>n.a.</u>	<u>n.a.</u>	<u>n.a.</u>	<u>n.a.</u>	Referenced PPS Sequence (IHE-A.2.2.2) <u>1.2.840.10008.3.1.2.3.3</u>	<u>1.2.840.10008.3.1.2.3.3</u> See (IHE-A.5.2.3)
<u>Referenced SOP Instance UID</u> (0008,1155)	<u>n.a.</u>	<u>n.a.</u>	<u>n.a.</u>	<u>n.a.</u>	<u>n.a.</u>		<u>Equal to SOP Instance UID of the associated MPPS</u> See (IHE-A.5.2.4)

(IHE-A.5-2.1) Performed Procedure Step ID is generated by the **i**Importer arbitrarily and is not necessarily unique: Two different Performed Procedure Steps may share the same ID (e.g., may have been generated by different importers).



- 1910 (IHE-A.5-2.2) The Referenced Performed Procedure Step Sequence (0008,1111) that contains the PPS SOP Instance UID shall be included (per DICOM PS3.3 section C.7.3 strong recommendation, General Series Module Table, Note 1).
- (IHE-A.5-2.3) In MPPS, SOP Class UID is sent in the Affected SOP Class UID (0000,0002) for the PPS N-Create message and in Requested SOP Class UID (0000,0003) for the PPS N-Set message. SOP Class UID (0008,0016) shall not be used.
- 1915 (IHE-A.5-2.4) In MPPS, SOP Instance UID is sent in the Affected SOP Instance UID (0000,1000) of the PPS N-Create message and in Requested SOP Instance UID (0000,1001) for the PPS N-Set message. SOP Instance UID (0008,0018) shall not be used.
- 1920 (IHE-A.5-2.5) Descriptions and Codes used in the Enterprise may not match those used in the Evidence Objects for Import. The method used to coerce the Descriptions or Codes is out of scope of the Technical Framework. Note that the Descriptions and Codes from the Evidence Objects may be useful.
- (IHE-A.5-2.6) Ideally, UIDs are universally unique, so there should be no risk of collision with local UIDs, and hence there should be no reason to change them. However, since the integrity of externally generated data cannot be ensured, it may be necessary to correct or re-generate UIDs. The UIDs are used as references between objects, and if they are altered, the Importer shall maintain referential integrity.
- 1925 (IHE-A.5-2.7) Performed Protocol Codes used in the Enterprise may not match those used in the Evidence Objects. Determination of whether to copy, coerce or remove the Codes is out of scope of the Technical Framework. Note that the Codes from the Evidence Objects may be useful.
- 1930 (IHE-A.5-2.8) See Section RAD TF-~~3~~ 4.59.4.1.2.3. The Performed Protocol Codes present in the Objects for Import may not match those used in the Evidence Objects. Determination of whether to merge, coerce and merge or ~~disgard~~**discard** the Codes is out of scope of the Technical Framework. Note that the Codes from the Evidence Objects may be useful.
- 1935 (IHE-A.5-2.9) **Other Patient IDs (0010,1000) shall not be included in the imported objects or MPPS message. It is redundant with Other Patient IDs Sequence (0010,1002) and insufficient as it does not allow the Assigning Authority to be conveyed for each Patient ID.**
- 1940

**Table A.5-3: Automated Order Placement and Scheduling - required mapping of corresponding attributes**

<u>DICOM attribute</u>	<u>Objects for Import</u>	<u>Request Filling of Order (returned ORI values)</u>	<u>Filling values for:</u>	
			<u>Resultant IOD</u>	<u>MPPS IOD</u>
<u>Patient Name (0010,0010)</u>	<u>Source-1</u>	<u>Source-2 PID:5</u>	<u>Copy-2 [Copy-1]</u>	<u>Copy-2 [Copy-1]</u>
<u>Patient ID (0010,0020)</u>	<u>Source-1</u>	<u>Source-2 PID:3</u>	<u>Copy-2</u>	<u>Copy-2</u>
<u>Issuer of Patient ID (0010,0021)</u>	<u>Source-1</u>	<u>Source-2 PID:3</u>	<u>Copy-2</u>	<u>Copy-2</u>
<u>Other Patient Ids (0010,1000)</u>	<u>Source</u>	<u>n.a</u>	<u>n.a (See IHE-A.5.3.9)</u>	<u>n.a</u>
<u>Other Patient IDs Sequence (0010,1002)</u>	<u>Source-1</u>	<u>Source-2 PID:3</u>	<u>Merge Copy-1,Copy-2</u>	<u>n.a</u>
<u>Patient's Birth Date (0010,0030)</u>	<u>Source-1</u>	<u>Source-2 PID:7</u>	<u>Copy-2 [Copy-1]</u>	<u>Copy-2 [Copy-1]</u>
<u>Patient's Sex (0010,0040)</u>	<u>Source-1</u>	<u>Source-2 PID:8</u>	<u>Copy-2 [Copy-1]</u>	<u>Copy-2 [Copy-1]</u>
<u>Study Instance UID (0020,000D)</u>	<u>Source (See IHE-A.5.3.6)</u>	<u>n.a (Copy used in Request Filling of Order OMI)</u>	<u>Copy or Equal (internally generated) (See IHE-A.5.3.6)</u>	<u>Scheduled Step Attributes Sequence (0040,0270)</u> <u>Copy or Equal (internally generated) (See IHE-A.5.3.6)</u> <u>Copy-2</u> <u>Copy-2</u> <u>Copy-2</u> <u>Copy-2</u>
<u>Accession number (0008,0050)</u>	<u>Source-1</u>	<u>Source-2 IPC-1</u>	<u>Copy-2</u>	
<u>Issuer of Accession Number Sequence (0008,0051)</u>	<u>Source-1</u>	<u>Source-2 IPC-1</u>	<u>Copy-2</u>	
<u>Requested Procedure ID (0040,1001)</u>	<u>Source-1</u>	<u>Source-2 IPC-2</u>	<u>Copy-2</u>	
<u>Scheduled Procedure Step ID (0040,0009)</u>	<u>Source-1</u>	<u>Source-2 IPC-4</u>	<u>Copy -2</u>	
<u>Scheduled Protocol Code Sequence (0040,0008)</u>	<u>Source-1</u>	<u>Source-2 IPC-6</u>	<u>Copy-2 [Copy-1] See (IHE-A.5.3.7)</u>	
<u>Performed Protocol Code Sequence (0040,0260)</u>	<u>Source-1</u>	<u>Source-2 IPC-6</u>	<u>Copy-2 [Copy-1] See (IHE-A.5.3.7)</u>	
<u>Study ID (0020,0010)</u>	<u>Source-1</u>	<u>Source-2 IPC-2</u>	<u>Copy-2 [Copy-1]</u>	<u>Copy-2 [Copy-1]</u>

<u>DICOM attribute</u>	<u>Objects for Import</u>	<u>Request Filling of Order (returned ORI values)</u>	<u>Filling values for:</u>	
			<u>Resultant IOD</u>	<u>MPPS IOD</u>
<u>Performed Procedure Step ID (0040,0253)</u>	<u>Source</u>	<u>n.a</u>	<u>Copy</u> <u>See (IHE-A.5.3.1)</u>	<u>Copy [Equal (Internally Generated)] See (IHE-A.5.3.1)</u>
<u>Performed Procedure Step Description (0040,0254)</u>	<u>Source</u>	<u>n.a</u>	<u>Copy</u> <u>See (IHE-A.5.3.5)</u>	<u>Copy</u> <u>See (IHE-A.5.3.5)</u>
<u>Performed Procedure Step Start Date (0040,0244)</u>	<u>Source</u>	<u>n.a</u>	<u>Copy</u>	<u>Equal (internally generated).</u>
<u>Performed Procedure Step Start Time (0040,0245)</u>	<u>Source</u>	<u>n.a</u>	<u>Copy</u>	<u>Equal (internally generated).</u>
<u>Requested Procedure Code Sequence (0032,1064)</u>	<u>n.a</u>	<u>Source</u> <u>OBR-44</u>	<u>n.a</u>	<u>n.a.</u>
<u>Procedure Code Sequence (0008,1032)</u>	<u>Source-1</u>	<u>Source-2</u> <u>OBR-44</u>	<u>Copy-2 [Copy-1]</u> <u>See (IHE-A.5.3.5)</u>	<u>Copy-2 [Copy-1]</u> <u>See (IHE-A.5.3.5)</u>
<u>Referenced SOP Class UID (0008,1150)</u>	<u>n.a.</u>	<u>n.a</u>	<u>Referenced PPS Sequence (IHE-A.2.2.2)</u>	<u>1.2.840.10008.3.1.2.3.3</u> <u>See (IHE-A.5.3.3)</u>
<u>Referenced SOP Instance UID (0008,1155)</u>	<u>n.a.</u>	<u>n.a</u>		<u>Equal to SOP Instance UID of the associated MPPS</u> <u>See (IHE-A.5.3.4)</u>

1945

**(IHE-A.5-3.1) Performed Procedure Step ID is generated by the Importer arbitrarily and is not necessarily unique: Two different Performed Procedure Steps may share the same ID (e.g., may have been generated by different Importers).**

1950

**(IHE-A.5-3.2) The Referenced Performed Procedure Step Sequence (0008,1111) that contains the PPS SOP Instance UID shall be included (per DICOM PS3.3 section C.7.3 strong recommendation, General Series Module Table, Note 1).**

1955

**(IHE-A.5-3.3) In MPPS, SOP Class UID is sent in the Affected SOP Class UID (0000,0002) for the PPS N-Create message and in Requested SOP Class UID (0000,0003) for the PPS N-Set message. SOP Class UID (0008,0016) shall not be used.**

**(IHE-A.5-3.4) In MPPS, SOP Instance UID is sent in the Affected SOP Instance UID (0000,1000) of the PPS N-Create message and in Requested SOP Instance UID**

**(0000,1001) for the PPS N-Set message. SOP Instance UID (0008,0018) shall not be used.**

1960 **(IHE-A.5-3.5) Descriptions and Codes used in the Enterprise may not match those used in the Evidence Objects for Import. The method used to coerce the Descriptions or Codes is out of scope of the Technical Framework. Note that the Descriptions and Codes from the Evidence Objects may be useful.**

1965 **(IHE-A.5-3.6) Ideally, UIDs are universally unique, so there should be no risk of collision with local UIDs, and hence there should be no reason to change them. However, since the integrity of externally generated data cannot be ensured, it may be necessary to correct or re-generate UIDs. The UIDs are used as references between objects, and if they are altered, the Importer shall maintain referential integrity.**

1970 **(IHE-A.5-3.7) Performed Protocol Codes used in the Enterprise may not match those used in the Evidence Objects. Determination of whether to copy, coerce or remove the Codes is out of scope of the Technical Framework. Note that the Codes from the Evidence Objects may be useful.**

1975 **(IHE-A.5-3.8) See Section RAD TF-3: 4.59.4.1.2.3. The Performed Protocol Codes present in the Objects for Import may not match those used in the Evidence Objects. Determination of whether to merge, coerce and merge or discard the Codes is out of scope of the Technical Framework. Note that the Codes from the Evidence Objects may be useful.**

1980 **(IHE-A.5-3.9) Other Patient IDs (0010,1000) shall not be included in the imported objects or MPPS message. It is redundant with Other Patient IDs Sequence (0010,1002) and insufficient as it does not allow the Assigning Authority to be conveyed for each Patient ID.**

1985

*Add TF Vol 3, Appendix K: Import Reconciliation Workflow Import Instruction Handling Option.*

## 1990 **Appendix K – Import Reconciliation Workflow Import Instruction Handling Option**

This appendix defines features that shall be supported by a DSS Order Filler, Importer, or Image Manager/Archive supporting the Import Instruction Handling Option for the Import Reconciliation Workflow (IRWF.b) Profile. The Import Instruction Handling Option allows an institution to set instructions to be used for imported data and have these acted upon by the Image Manager/Archive receiving this data.

1995

- Section K.1 specifies how a DSS/Order Filler shall support providing Import Instruction Codes to the Importer and Image Manager/Archive.
- Section K.2 specifies how an Importer shall support providing source Institution information to the Image Manager/Archive and provide configurable and user selectable support for setting Import Instruction Codes.
- Section K.3 specifies how an Image Manager/Archive shall support handling Import Instruction Codes.

2000

### **K.1 DSS/Order Filler Requirements**

#### 2005 **K.1.1 DSS/Order Filler User Selectable Import Instruction Code Mapping**

A DSS/Order Filler supporting the Import Instruction Handling Option shall have the ability for an operator to add and modify the Import Instructions in the following:

2010

- The Scheduled Protocol Code of the Procedure Scheduled [RAD-4] transaction (see RAD TF-2: 4.4.4.1.2.1.5.1.2 and 4.4.4.1.2.2.8.1.2).
- The Scheduled Protocol Sequence (0040,0008) of the Modality Worklist [RAD-5] transaction (see RAD TF-2: 4.5.4.2.2.1.1).

### **K.2 Importer Requirements**

#### **K.2.1 Importer Institution Name Mapping**

2015

The Image Manager/Archive receiving imported objects may need to be able to determine the actual site where data was originally acquired in order to decide how it shall be handled. If the Image Manager/Archive is receiving the objects via the Imported Objects Stored [RAD-61] transaction then it is dependent upon the Importer to ensure this information is provided. This section defines how an Importer shall provide this information for import over the network.

2020

Note that if the Image Manager/Archive is directly receiving data over the network and supports the Scheduled Workflow Multiple Identity Resolution Option then it will support the configurable ability to assign the Institution Name.

### K.2.1.1 Importer Configurable Institution Name Mapping for Objects Received Over the Network

2025 The Importer supporting the Import Instruction Handling Option shall maintain a configurable mapping of a default Institution Name (0008,0080) and Institution Code Sequence (0008,0082) for objects received over the network:

- to each external actor for which it receives DICOM objects.

2030 For import of objects received over the network, the Importer shall support the configurable mapping to a particular default Institution Name and Institution Code Sequence based on each of the following values for these systems:

- Host name or IP address
- Source AE Title for DICOM network communication
- SourceId for XDS based network communication

2035 See K.2.1.2. for the specification of how Institution Name (0008,0080) and Institution Code Sequence (0008,0082) are to be added to the objects exported by the Importer. The Importer shall first check if these attributes are already present with values in the DICOM object. If so then it shall not alter the specified values.

2040 If it is not possible to provide this configurable mapping, such as if the sending system could have objects acquired at multiple different institutions, then the Institution Name (0008,0080) and Institution Code Sequence (0008,0082) shall not be added by the Importer.

### K.2.1.2 Importer Message Semantics when Sending SOP Instances

If possible, the Importer sending a SOP Instance shall provide the Institution Name (0008,0080) and Institution Code Sequence (0008,0082) so that the institution where the SOP Instance was created is identified.

2045 The Importer shall support sending attributes in the images as defined in the following table:

**Table K.2.1.2-1: Institution SOP Instance Attributes for Import Instruction Handling**

Attribute	Tag	Required	Rationale
Institution Name	(0008,0080)	R+	Used to convey the institution where the SOP Instance was created.
Institution Code Sequence	(0008,0082)	R+	Used to convey the institution where the SOP Instance was created.
>Code Value	(0008,0100)	R	
>Coding Scheme Designator	(0008,0102)	R	
>Coding Scheme Version	(0008,0103)	RC	Required if the value of Coding Scheme Designator (0008,0102) is not sufficient to identify the Code Value (0008,0100) unambiguously. May be present otherwise.

Attribute	Tag	Required	Rationale
>Code Meaning	(0008,0104)	R	

## K.2.2 Importer Import Instruction Code Setting

2050 An Importer supporting the Import Instruction Handling Option of Import Reconciliation Workflow shall have the ability to add and modify the Import Instructions (see RAD TF-2: 4.5-4) in the Request Filling of Order [RAD-78] transaction.

### K.2.2.1 Importer Configurable Import Instruction Code Mapping for Objects Received Over the Network

2055 The Importer supporting the Import Instruction Handling Option shall maintain a configurable mapping of default Import Instructions (see RAD TF-2: 4.5-4) to specify in the Request Filling of Order [RAD-78] created for objects received over the network:

- to each external actor for which it receives DICOM objects.

2060 For import of objects received over the network, the Importer shall support the configurable mapping to particular default Import Instruction Codes on each of the following values for these systems:

- Host name or IP address
- Source AE Title for DICOM network communication
- sourceId for XDS based network communication
- homeCommunityId for XCA-based network communication
- 2065 • Institution Name (0008,0080) and Institution Code Sequence (0008,0082) of the received DICOM objects.

## K.3 Image Manager Requirements

### K.3.1 Image Manager Import Instruction Code Handling

2070 An Image Manager supporting the Import Reconciliation Workflow Import Instruction Handling Option shall have the ability to use the Import Instructions (see RAD TF-2:4.5-4) provided by the DSS/Order Filler or Importer.

The Image Manager shall support the configurable ability to take the following actions for the corresponding imported Study.

**Table K.3.1-1: Import Instruction Code Handling**

Category	Coding Scheme Designator (0008,0102)	Code Value (0008,0100)	Code Meaning (0008,0104)	Image Manager Action
Archive	IHERADTF	IRWF003	To be archived	Image Manager shall archive the

Category	Coding Scheme Designator (0008,0102)	Code Value (0008,0100)	Code Meaning (0008,0104)	Image Manager Action
Instructions				Study
	IHERADTF	IRWF012	Do not archive	Image Manager shall not archive the Study.
Workflow Instruction	IHERADTF	IRWF002	To be interpreted	Image Manager shall add the Study to the list of Studies to be read.
	IHERADTF	IRWF004	To be over read	Image Manager shall add the Study to the list of Studies to be over read.
	IHERADTF	IRWF005	To be post-processed	Image Manager shall add the Study to the list of Studies to be post-processed.
Type of Data	IHERADTF	IRWF007	To be provided as a prior	Image Manager shall not add the Study to the list of Studies to be read.
	IHERADTF	IRWF013	To be sequestered for teaching	Image Manager shall treat the Study as a reference Study for teaching purposes and not associate the Study with any particular patient.
	IHERADTF	IRWF014	To be sequestered for research	Image Manager shall treat the Study as a Study for research purposes and not associate the Study with any particular patient.

2075

**Editor:** Add the following rows to RAD TF-3: Table 5.1-2

**Table 5.1-2: IHE Radiology transactions and resulting ATNA trigger events**

IHE Radiology Transaction	ATNA Trigger Event(s)	Actor(s) that shall be able to record audit event
Patient Registration [RAD-1]	Patient-record-event	ADT, Order Placer, DSS/OF - when PHI is presented
...		
Cross Gateway Retrieve Imaging Document Set [RAD-75]	Instances-Stored	Responding Imaging Gateway
	Study-used	Initiating Imaging Gateway
<b><u>Query for Study [RAD-76]</u></b>	<b><u>Query Information</u></b>	<b><u>Importer</u></b> <b><u>Image Manager/Archive</u></b>
<b><u>Query for Patient ID [RAD-77]</u></b>	<b><u>Query Information</u></b>	<b><u>Importer</u></b> <b><u>Image Manager/Archive</u></b>
<b><u>Request Filling of Order [RAD-78]</u></b>	<b><u>Order-record-event</u></b>	<b><u>Importer</u></b> <b><u>DSS/Order Filler</u></b>