

Integrating the Healthcare Enterprise



5 **IHE Patient Care Devices (PCD)**
White Paper

10 **Service-oriented Device Point-of-Care**
Interoperability (SDPi)

*Device-to-Device Connectivity in High-Acuity Healthcare
Environments using Web Services Technology*

15 **Revision 1.0 – Draft for Public Comment**

20 Date: August 23, 2019
Author: IHE PCD Technical Committee
Email: pcd@ihe.net

25 **Please verify you have the most recent version of this document. See [here](#) for Published
Versions and [here](#) for Public Comment versions.**

Foreword

This is a white paper of the IHE Patient Care Device domain.

- 30 This white paper is published on August 23, 2019 for Public Comment. Comments are invited and can be submitted at https://www.ihe.net/PCD_Public_Comments. In order to be considered in development of the subsequent version of the white paper, comments must be received by September 22, 2019.
- 35 General information about IHE can be found at: www.ihe.net.
Information about the IHE Patient Care Device domain can be found at: ihe.net/IHE_Domains.
Information about the organization of IHE Technical Frameworks and Supplements and the process used to create them can be found at: http://ihe.net/IHE_Process and <http://ihe.net/Profiles>.
- 40 The current version of the IHE Patient Care Devices Technical Framework can be found at: http://ihe.net/Technical_Frameworks.

CONTENTS

45	1	Introduction.....	8
	1.1	Purpose of the SDPi White Paper.....	8
	1.2	Intended Audience.....	8
	1.3	Open and Closed Issues.....	9
50		Open Issues and Questions.....	9
		Closed Issues.....	9
	2	References to other Standards.....	12
	3.0	“From the device interface ...”.....	13
	4.0	SDPi - Scope & Application Context.....	16
55	4.1	Scope & Purpose.....	16
	4.2	Application Contexts.....	16
	4.3	Document Organization, Conventions & Abbreviations.....	17
	5.0	“DPI” Device-to-Device Interoperability Overview.....	22
	6.0	IHE Process.....	27
60	6.1	Big Picture.....	27
	6.2	Global Community.....	28
	6.3	Domains & Technical Frameworks.....	29
	6.4	Interoperability Testing Events.....	31
	6.5	Conformity Assessment & Product Certification.....	32
65	6.6	Public Demonstrations, Projectathons,	33
	7.0	IHE PCD “Device” Technical Framework.....	35
	7.1	IHE PCD Domain Overview.....	35
	7.2	Standards-based Technical Approach.....	36
	7.3	PCD Core Interoperability Profiles.....	36
70	7.4	Tooling, Connectathons, Demonstrations, Products.....	37
	7.4.1	General IHE Test & Tooling.....	38
	7.4.2	Proposed NIST Framework Integrating SDPi Support.....	41
	7.4.3	Evolving SDC Community Tooling.....	42
	7.4.4	Integrating IHE & NIST Tooling Frameworks with SDC Community Tooling.....	45
75	8.0	IEEE 11073 SDC Overview.....	46
	8.1	Service-oriented Device-to-device Connectivity.....	46
	8.2	IEEE 11073 SDC Standards Family - Overview.....	48
	8.3	Functional vs. Non-functional Requirements.....	52
	8.4	Gateways Connecting Point of Care & Hospital Enterprise.....	52
80	8.5	SDC from an ASTM/AAMI ICE Conceptual Model Perspective.....	54
	8.6	Semantic Model: From Nomenclature to Information Models.....	57
	8.7	Service Model: From abstract ICE to SOMDA to WS-*.....	60
	8.7.1	Basic ICE Protocol Specification (BICEPS) Services.....	61
	8.7.2	Service Oriented Medical Device Architecture (SOMDA).....	63
85	8.7.3	Medical Device Profile for Web Services (MDPWS).....	64
	8.7.4	WS-* Profiles: IHE ITI vs. SDC’s MDPWS.....	66

	8.7.5 SDC Discovery & Service-based Exchange Examples	67
90	9.0 General Profiling Considerations.....	70
	9.1 General Connectivity to Device Specializations.....	70
	9.1.1 Rationale for Path to Device Specializations.....	70
	9.1.2 Approach for Device-specific Profiles	72
	9.1.3 SDC Device Specialization Examples.....	73
	9.2 The Holistic Interoperability Pitfall	75
	9.3 Time Synchronization Challenges	76
95	9.4 Device ID & Configuration Management + FDA UDI Challenges	78
	9.5 Regulatory Requirements & Approach.....	79
	9.6 Security & Privacy Considerations.....	80
	9.7 Safety Considerations & Risk Management Support	82
	9.8 Interoperability Maturity Models for SDC Roadmapping.....	84
100	9.8.1 Modeling Interoperability: Past, Present & Future.....	84
	9.8.2 Assessing Standards Maturity & Fit for Purpose	86
	9.8.3 MDI “State of the Union” Maturity & IEEE 11073 SDC	89
	9.9 Considering Additional Integration Architectures – RESTful, DDS,	91
105	10.0 SDPi: Integrating SDC into IHE Technical Frameworks	94
	10.1 Technical Framework Approach.....	94
	10.1.1 Use Cases & Requirements	94
	10.1.1.1 Example: NITRD ‘19 MDI Use Case.....	100
	10.1.1.2 Example: IHE PCD “Quiet Hospital” — Device to Clinician and Back- again	104
110	10.1.1.3 Example: Preeclampsia During Pregnancy Across the Continuum of Care	107
	10.1.2 From DPI to SDC to: SDPi	109
	10.1.3 Approach for Mapping SDC to IHE.....	110
	10.1.4 Safety & Security Considerations	112
115	10.1.5 IHE Domain Coordination	112
	10.1.6 Integration with Devices on FHIR® Implementation Guidance.....	112
	10.2 Volume 1: Interoperability Profiles	113
	10.2.1 Profile: SDPi – Core SDC Capabilities.....	114
	10.2.2 Profile: SDPi-R for Reporting.....	115
120	10.2.3 Profile: SDPI-A for Alerting.....	116
	10.2.4 Profile: SDPI-xC for External Control	117
	10.2.5 Future Profile: Device Specializations (DS)	118
	10.3 Volume 2: Technical Transactions	118
	10.4 Volume 3: Semantic Content Modules	119
125	11.0 Roadmap & Timeline.....	120
	Appendices.....	124
	Appendix A – Glossary.....	125
	Appendix B – Bibliography.....	126
	Appendix C – IHE Enterprise Facing Connectivity Profiles	129

130	C.1 IHE Technical Framework Elements	130
	C.2 PCD Profile: Device to Enterprise Communication (DEC)	130
	C.2.1 General Device Data Reporting.....	131
	C.2.2 DEC Waveform Content Module (WCM)	133
	C.2.3 DEC Observation Filter – Subscribe to Patient Data	134
135	C.3 PCD Profile: Alert Communication Management (ACM).....	136
	C.4 PCD Profile: Point-of-care Infusion Verification (PIV)	139
	C.5 PCD Profile: Infusion Pump Event Communication (IPEC)	141
	C.6 PCD Profile: Point-of-Care Identity Management (PCIM)	142
	C.7 PCD Profile: Rosetta Terminology Mapping (RTM).....	143
140	C.8 ITI Profile: XDS on FHIR – Mobile Access to Health Documents (MHD).....	144
	Appendix D – Compendium of Medical Device Oriented Use Cases.....	145
	Appendix E – SDC Message Examples.....	154
145	FIGURES	
	Figure 1 BICEPS Medical Device System Contexts	17
	Figure 2 IHE Process: From Standards to Products to Improved Healthcare.....	27
	Figure 3 IHE Process: Connecting Healthcare Technology Stakeholders.....	28
	Figure 4 IHE National & Regional Deployment Committees	29
150	Figure 5 IHE Global vs. Regional Development	30
	Figure 6 IHE Plug-a-thon Process	32
	Figure 7 IHE PAT to CAT to CA - Increasing Conformity Rigor ¹⁷	33
	Figure 8 IHE @ Public eHealth Projects & Projectathons	34
	Figure 9 NIST Validation Tooling Framework	39
155	Figure 10 NIST: Isolated vs. P2P / Networked System Testing.....	40
	Figure 11 NIST: Conformance to Interoperability Testing Phases	40
	Figure 12 NIST Tooling Framework for Device Profiling & Validation (Proposed)	41
	Figure 13 Example of SDC Compliance Check Tool.....	43
	Figure 14 Example of SDC Role-based test suite ²¹	44
160	Figure 15 Reference System concept.....	44
	Figure 16 SOMDA Conceptual Model	47
	Figure 17 Example: SOMDA Clinical Workplace	48
	Figure 18 IEEE 11073 SDC Family of Standards (“Cathedral Window”).....	49
	Figure 19 BICEPS Standard Components	51

165	Figure 20 SDC Point-of-Care Gateway to Hospital Enterprise Systems.....	53
	Figure 21 Mapping of IEEE 11073 SDC to ICE Conceptual Model.....	55
	Figure 22 Alternative Mapping of IEEE 11073 SDC to ICE Conceptual Model.....	56
	Figure 23 SDC Medical Device Information Model	58
	Figure 24 SDC 11073 Core Standards - Functional Scope.....	60
170	Figure 25 SDC BICEPS Service Model	61
	Figure 26 Comparison of 11073 "Classic" to BICEPS Service Models.....	63
	Figure 27 WS-* Reference Profile Stack.....	65
	Figure 28 MDPWS Extended Capabilities	66
	Figure 29 SDC Basic Discovery & Exchange	67
175	Figure 30 Example: Smart App & Vital Signs Monitor Discovery.....	68
	Figure 31 Example: Remote "Set Service" Invocation.....	69
	Figure 32 Example SDC Device Specialization - High-Frequency Surgery Device.....	74
	Figure 33 Example SDC Device Specialization – Gateway & "Smart" Devices	75
	Figure 34 IHE PCD Time Synchronization Capabilities.....	77
180	Figure 35 SDC "V" Model for V&V	79
	Figure 36 Proposal: Standard Quality System Interface (SQSI) Architecture for Risk Managed MDI.....	82
	Figure 37 AAMI 2012 MDI - Levels of Interoperability	85
	Figure 38 MDI Maturity Model (Fuchs/C4MI).....	86
185	Figure 39 Standards Readiness Model for National Adoption (JAMIA) ⁶⁶	88
	Figure 40 European Horizons 2020 eStandards "Maturity" Process	89
	Figure 41 SDC R&D History.....	91
	Figure 42 SDC Library - MDPWS Connectivity	92
	Figure 43 SDC Library - DDS Connectivity	93
190	Figure 44 FESS-1: Surgeon View of Patient Vitals - System Context Diagram.....	96
	Figure 45 FESS-1: Viewing Patient Vitals by a Surgeon – Dynamic System Behavior.....	96
	Figure 46 FESS-2: Surgeon Control of OR Light - System Diagram	97
	Figure 47 FESS-2: Surgeon Control of OR Light – Dynamic System Behavior	98
	Figure 48 FESS-4: Technical Alert to Biomedical - System Context	99
195	Figure 49 FESS-4: Technical Alert to Biomedical – Dynamic Behavior.....	99

	Figure 50 FESS-5: Seamless Exchange of Medical Devices - System Context.....	99
	Figure 51 FESS-5: Seamless Exchange of Medical Devices – Dynamic System Behavior	100
	Figure 52 NITRD-2: Capture of Device Data & Settings - Dynamic System Behavior	103
	Figure 53 NITRD-4: Autonomous Patient Therapy - Dynamic System Behavior.....	104
200	Figure 54 SDC "Quiet Hospital" Interaction Diagram	106
	Figure 55 Preeclampsia During Pregnancy (PDP) Use Case.....	109
	Figure 56 IEEE SDC to HL7 FHIR Comparison.....	113
	Figure 57 Example: SDPi General Capabilities.....	115
	Figure 58 Example: SDPi Reporting	116
205	Figure 59 Example: SDPi External Control.....	117
	Figure 60 SDC Example Information Flow Labels	118
	Figure 61 IHE Technical Framework – Elements Model.....	130
	Figure 62 IHE PCD DEC Actor Diagram.....	132
	Figure 63 IHE DEC Profile Options Table.....	133
210	Figure 64 IHE PCD Waveform Content Module (WCM) Model	134
	Figure 65 IHE PCD DEC SPD Option Actor Model.....	135
	Figure 66 IHE PCD ACM Profile Actor Diagram (internal perspective)	137
	Figure 67 IHE PCD ACM Profile Actor / Transaction Flow Diagram	137
	Figure 68 IHE PCD ACM Actors & Transaction Table.....	138
215	Figure 69 IHE PCD ACM Profile Options Table.....	138
	Figure 70 IHE PCD - Alerts vs. Events	139
	Figure 71 Point-of-care Infusion (6 Rights) Verification (PIV) Use Case	140
	Figure 72 IHE PCD PIV Profile Actor Diagram	140
	Figure 73 IHE PCD IPEC Actor Diagram.....	141
220	Figure 74 IHE PCD IPEC - Example Event Sequence.....	142
	Figure 75 IHE PCD PCIM Profile – Actor Model	143
	Figure 76 IHE PCD PCIM Profile – Options	143
	Figure 77 IHE MHD "XDS on FHIR" Model	144

225 **1 Introduction**

This document, the IHE PCD Service-oriented Device Point-of-care Interoperability (SDPi) White Paper, describes the use of IEEE 11073 Service-oriented Device Connectivity (SDC) device-to-device interoperability technology that is optimized for high-acuity environments (e.g., operating rooms, intensive care units, or emergency departments), and explores how it can be integrated into IHE technical framework components, proposing a roadmap and timeline leading from IHE SDPi Profile specifications to IHE connectathon testing and ultimately IHE conformity assessment and product certification.

1.1 Purpose of the SDPi White Paper

This white paper explores how IEEE 11073 SDC-based medical device-to-device interoperability (MDI) might be supported in IHE technical framework specifications and proposes a roadmap and timeline for achieving this integration, leading from the development of SDPi Profile specifications to IHE conformance testing events and ultimately to product certification. The paper not only provides background information on SDC / WS-*-based technology and IHE processes and specifications, but also identifies relationships between the primary use contexts - namely, high-acuity care contexts such as OR, ICU and ED - and others such as healthcare enterprise integration using established IHE PCD profiles such as DEC, PIV, and ACM, or home and other non-acute care environments leveraging the emerging Devices on FHIR (DoF) implementation guidance or Continua specifications. IEEE 11073 SDC spans from device reporting (from discrete parameters to continuous waveforms), to alerting (from physiological medical alarms over technical alarms to informative event notes), to controlling (from directed external control to closed-loop device-to-device controls).

1.2 Intended Audience

The intended audience of this IHE PCD SDPi white paper include:

- All individuals and organizations involved in the development, integration & use of connected medical technology for acute care environments
- Clinical technologists / engineers (“users”) & system implementers / integrators
- Medical technology developers & vendors (especially for acute care environments)
- Regulatory & governmental agencies & public policy makers
- Enterprise system developers and integrators of device-based content and services
- Researchers & Medical Device Informatics Subject Matter Experts

Note that though the IHE PCD scope has been traditionally focused on Point-of-Care Devices (PoCD) such as physiological / vital signs monitors and infusion pumps, SDC is designed to integrate a much broader set of equipment. This will result in the need to integrate with

260 interoperability technologies that are established for those systems (e.g., DICOM^{®1} for imaging),
as well as with other IHE domains such as IT Infrastructure, Radiology or Surgery.

265 Finally, this document recognizes that some readers may be very familiar with IEEE 11073 SDC,
but not IHE, others versed in IHE, but not IEEE 11073 SDC, and yet others are not versed in
either IEEE 11073 SDC or IHE, but know medical device interoperability challenges, especially
in high-acuity environments. This white paper is organized to provide the information needed for
all three of these audiences to fully understand, contribute to and approve the recommendations
for how SDC-enabled systems might be integrated into IHE technical specifications, processes
and events. What the paper does not attempt to do is provide in-depth understanding for any of
the topics, but general overview information with references for in-depth discussions.

1.3 Open and Closed Issues

270 The questions and issues below are of particular importance for understanding the rationale
behind the published content of the white paper as well as areas that remain for future discussion
and resolution.

Open Issues and Questions

275 **SDPi-4:** Should a terms and definitions section be added? Currently terms are defined when
necessary and some in the 4.3 Conventions section below. Also, a Glossary appendix is
allocated. Since this is only a white paper and not a formal specification, the intent was that
defining when and where and only when needed – and then on-the-spot – is sufficient. But
consider ...

- Alert: Alarm & Events
- 280 • Alert Delegation: Capability of a POC MEDICAL DEVICE to let another
- PARTICIPANT generate a POC MEDICAL DEVICE's ALERT SIGNAL as primary
ALERT SIGNAL in order to indicate the presence of an ALERT CONDITION on the
POC MEDICAL DEVICE. [BICEPS]
- high-acuity environments: ICU, OR, ED, step down, Intermediate care, ...
- 285 • ...

Closed Issues

SDPi -1: Extensive use case / requirements analysis has been performed in this area over
decades and geographies: What should be leveraged by this white paper, and how should it be
organized?

¹ DICOM is the registered trademark of the National Electrical Manufacturers Association for its standards
publications relating to digital communications of medical information.

- 290
- These include the SDC/OR.net program, IHE DPI, MDPnP ICE, IEEE 11073 “classic” w/ CEN/TC 251, etc.
 - **Resolution:** See *Use Cases & Requirements and Appendix D – Compendium of Medical Device Oriented Use Cases*.

295 **SDPi-2:** Wired vs. wireless connectivity: What transport-level guidance should be factored into this white paper? For example, wired interfaces have historically been chosen over wireless in high-noise OR environments.

- There is no special consideration regarding wired or wireless network, but as mentioned for noisy environments wireless might not be the right choice if real-time control loops should be applied.
- 300
- SDC has similar to IHE PCD RQD the optional Archive Service that can be used backfilling for connection loss or on transport if the product otherwise operates on wired connections.

305 **SDPi-3:** How should remote clinician control of alert settings be handled? IEEE 11073 SDC alert delegation will be handled in the SDPi-Alerting Profile, including the feedback from the clinician that may result in alert annunciation at the device or at the point-of-care. What is the dividing line between adjusting device parameters – including alert-related settings – using the SDPi-External Control profile vs. capabilities built into the SDPi-Alerting profile?

- General approach (**Resolution**):
 - Alert Signal Delegation uses an Operation that is invoked without OPERATOR action. The Operational behavior is already defined in BICEPS. As this is analogous to a heart-beat function, it is part of the Alerting Profile, but only the constraints regarding timeouts, risk management ... will be defined.
 - The Confirmation (Accept/Reject, etc.) is an OPERATOR action and will most likely be part of the External Control profile.
 - Current idea is to normatively include the Alerting profile in the External Control Profile for the relevant sections.
 - The semantics of the Operation will be in the External Control Nomenclature.
 - How should remote adjustment of alert limits be accomplished?
 - Described in the External Control Profile with a normative reference to Alerting profile.
 - NOTE: Users will expect the IHE PCD SDPi Profile “bundle” for -Alerting to include remote alert limit adjustment. It should be very clear what is needed to accomplish this, especially in device specialization profiles.
 - How does this apply to other technical settings? (assume @ -External Control)
- 325
- Triggering updated readings, such as blood pressure cuff? (assume @ -External Control)

- The general Operational Mode pattern is part of External Control and will be referenced as mandatory in the NIBP DevSpec.
- Therapeutic settings (e.g., breath rate or drug dose) would clearly fall into SDPi-External control
- 330 ● Is the alerting example the exception with all other device-external changes being provided via SDPi-External Control? Or is there a heuristic here that should be followed?
 - If it is an OPERATOR action ==> External Control or ModSpec.
 - If it is an ALGORITHM action ==> External Control or ModSpec.
- 335

2 References to other Standards

This document refers to standards from various Standards Development Organizations (SDOs), with specific details contained in Appendix B – Bibliography. The following copyright notices are included as appropriate:

340 **IEEE Copyright Notice**

IEEE draft and approved standards are copyrighted by IEEE. They are made available for a wide variety of both public and private uses. These include both use, by reference, in laws and regulations, and use in private self-regulation, standardization, and the promotion of engineering practices and methods. By making these documents available for use and adoption by public
345 authorities and private users, IEEE does not waive any rights in copyright to the documents.

More information can be found at this link: <https://standards.ieee.org/ipr/disclaimers.html>.

3.0 “From the device interface ...”

350 Before starting the journey into this white paper, there are some general perspectives that will help ensure readers have a consistent understanding of the subject at hand – especially given the many ways even the simplest phrase is overloaded with decades of different meaning, such as: Plug-and-play (PnP) ... how hard can that be?!

355 The phrase “*from the device interface...*” helps clearly establish the primary interoperability focus of the IEEE 11073 service-oriented device connectivity (SDC) standards, namely the closest communication point to where the information and services are made available to device-external systems - the “device interface”. Given the near complete lack of implementation realization of standardized medical device communication technologies, when device communication is discussed, it involves an array of adaptors, translators, and ultimately gateways to exchange even a minimum of device-sourced content for consumption by other systems and applications. Though SDC does support interoperability-through-gateway approaches, especially outside of the intended use contexts (e.g., operating rooms), the primary focus is on device-to-device interoperability without any intermediary architecture components.

360 “*Interface*”? First off, when the word “interface” is used in this document it does not mean “user interface” but a “computer interface”. Think Ethernet, TCP/IP, Bluetooth, USB ... When the idea of a user interface is being conveyed, the words “user interface” will be used. OK?

370 *Plug-and-Play (PnP)*? is often touted as an objective of standardized MDI architecture – “Why can’t my medical devices work the way my USB or Bluetooth devices connect?” As anyone who has designed PnP systems, there is always the question of “Where do you draw the pre-coordination vs. dynamic discovery line?” There are always foundational assumptions that are necessary to establish even the most basic level of communication between two systems.² There is a design tradeoff though between the complexity of a participating system’s interface and where the PnP line is drawn. One very simple device could simply connect and say “I’m here” and assume that the receiving device or system knows everything else needed to establish meaningful communication. This of course drives up the complexity of the 2nd system and when scaling over 100’s to 1,000’s of devices, the complexity factor results in unwieldy, brittle and even unsafe, albeit “interoperable” systems. SDC is optimized to support PnP strategies that enable striking a balance between all participating systems.³ As the old adage states: Simple to use is simple to say. Beware plug-and-play!

380 *Device-to-Device*? The emphasis in this white paper is on SDC-based device-to-device connectivity. That means there is no need to have a Device-to-Manager-to-Device communication path, but one could literally connect a physio monitor to an endoscope (directly or via a shared network) and have the two devices automatically and independently establish communication and utilize the services each provides. Of course, a centralized manager approach

² Consider mutual contextual beliefs (MCB’s) in linguistic pragmatics.

³ See IMPLICIT and EXPLICIT discovery examples in section 8.7.5 *SDC Discovery & Service-based Exchange Examples*.

385 could be implemented using SDC, but the focus is on devices and applications sorting it out and connecting directly. Simplicity first.

Interoperability? Complexity vs. API's, Open Source ... isn't that enough? Much has been written about “interoperability” and like PnP above, some degree of its meaning is “in the eye of the beholder” with numerous interoperability maturity models having been developed, even specifically for medical device technology. A well architected interoperability solution separates concerns into specific areas, allowing changing of one architectural component without impacting the others, and combining the Flexibility! But implementers often say, “Dude, that’s way too complex! Can’t I just get a library and program to a standard API?” Of course, but unless you have worked out all the stuff under-the-hood, the wheels may come off over 30 MPH! SDC as described in this white paper has both the rigorous attention to detail as well as the support for open source libraries and APIs that facilitate efficient solution design and implementation. Best of both worlds!

Bidirectional – what is the big deal? Most standards-based, even proprietary device interfaces support the “reporting” of information only, and do not allow for external control – bidirectional communication – of even the simplest of non-safety-critical capabilities. Some devices with serial interfaces have even cut the Rx line to completely eliminate that possibility! Note that “bidirectional” does not mean that ALL communication is transmit only. Communicating systems transmit and receive information, if only to support basic connection, discovery and association. In this document “bidirectional” refers to a system’s ability to both report information as well as consume information provided by other participating systems and applications. To both provide external control functions as well as invoke functions in connected devices. SDC is designed to support this level of bidirectional communication or “reporting only” for those devices that only support providing information.

Device vs. Medical Device: SOA & PnP in a regulated world? It is assumed that all readers of this document are familiar with the distinction between general devices used in healthcare contexts and *medical* devices that have a specific medical purpose (“intended use”) and especially in high-acuity care environments can pose significant safety risks if they do not function properly. Those who have been involved in the MDI area are also familiar with the challenges around PnP and SOA (Service Oriented Architecture) interoperability technologies and the challenges that they pose to regulatory authorities in terms of “clearing” a component of a system (e.g., a single network device participant) to be sold on the market and placed into use on patients. The historic alternative – and one that has driven the persistence of proprietary protocols – is the need to validate the entire system, including all possible combinations of networked devices and applications. SDC addresses this directly as discussed later in this white paper, and thus can be considered a disruptor to the status quo of MDI in high-acuity care.

420 Finally ...

Reinventing the Wheel? Everything that is conveyed in this white paper builds on established MDI standards and solutions, painting a picture of how SDC interoperability can be realized within the existing ecosystem, seamlessly and effectively. WS-* and SOAP are used throughout the industry, and not just healthcare IT. It supports both wired and wireless infrastructure, and as

425 illustrated in the numerous “gateway” proposals below, is designed to interface with other established, or in the case of MIoT ... “emerging”, standards-based technologies. Yes, some elements of SDC reflect concepts and solutions that have existed for decades – and that is a good thing!

430 An overview of the document’s structure and content is provided in section *Document Organization, Conventions & Abbreviations* below, and there are a number of sections that expand and extend the notions above, though, including “*DPI*” *Device-to-Device Interoperability Overview* and *General Profiling Considerations*.

Enjoy!

4.0 SDPi - Scope & Application Context

435 4.1 Scope & Purpose

This white paper provides an overview of medical device interoperability (MDI) “from the device interface” for point-of-care medical technology in high-acuity healthcare contexts, such as OR, ICU or ED, reviews the IEEE 11073 Service-oriented Device Connectivity (SDC) standards family, and presents a proposal – both technical approach and program roadmap – for inclusion of IEEE 11073 SDC into the IHE Patient Care Device (PCD) technical framework.

440 Specifically, a set of Service-oriented Device Point-of-care Interoperability (SDPi) IHE PCD profiles are proposed, along with the implementation support and conformity assessment / certification tooling that will be necessary in order to realize IHE SDPi-enabled products that healthcare providers can implement and use. Moreover, SDPi is developed to be a fundamental tool to implement the “SDC Conformance Principles” [SDCCP⁴] as laid out by OR.NET that needed for placing SDC-enabled products on the market in an open, extensible and interoperable environment.

IHE International is global in scope, as are the SDPi proposals in this white paper. It is recognized, though, that some regional and national adaptations or “extensions” may be required. SDPi connected systems will necessarily interact with other IHE technical framework profiles and domains (e.g., ITI patient information sharing profiles), as well as leveraging other non-IHE health informatics standardization efforts (e.g., integration with the HL7^{®5} FHIR^{®6} Standard).

455 Out of scope for this document is to fully address all the issues that will necessarily be resolved when the proposed roadmap is executed, starting with the development of IHE technical SDPi Profile specifications to IHE Connectathon testing and conformity assessment.

This white paper will chart the journey ahead with a “Start Here” way marker.

4.2 Application Contexts

460 Even if primary focus of this white paper is medical technology deployed in high-acuity environments of care, the underlying Web Services (WS-*) standards and technologies are extensively implemented in diverse network architectures and use environments. The focus of IEEE 11073 SDC on the challenges posed by device and system interoperability in the operating room, intensive care unit and emergency department (OR, ICU & ED, respectively), ensure that patient safety, healthcare quality as well as overall efficiency requirements are fully addressed. To that end, the BICEPS standard identifies six different use contexts as well as the core SystemContext (e.g., production related information) and the associated services and information that may be recognized by a device, as illustrated in the following diagram:

⁴ See OR.NET e.V., SDC Conformance Principles, D02, Jan. 2019, see *Appendix B – Bibliography*.

⁵ HL7 is the registered trademark of Health Level Seven International.

⁶ FHIR is the registered trademark of Health Level Seven International.

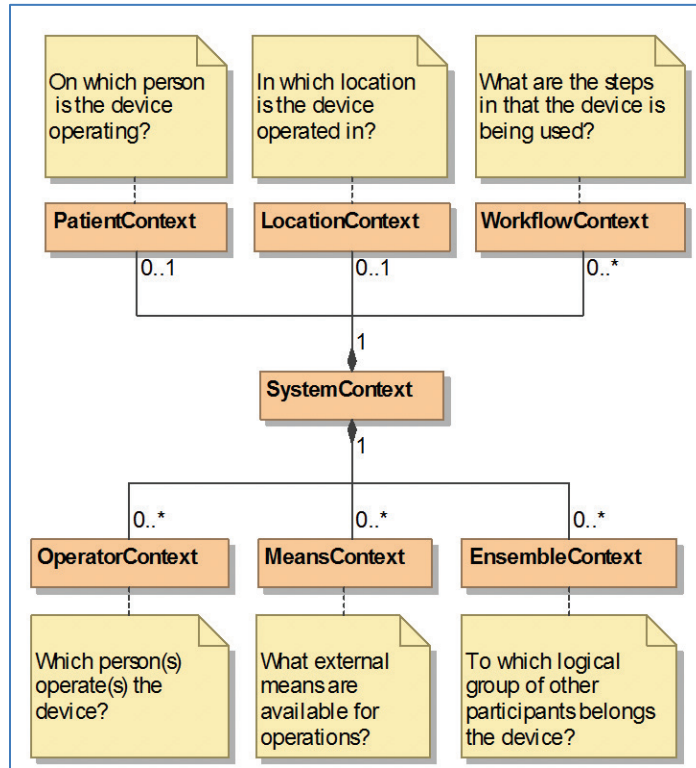

Figure 1 BICEPS Medical Device System Contexts⁷

470 It is recognized that given the broad use of WS-* technology, including in healthcare
 applications, IEEE 11073 SDC enabled technology and networks may be used in all high-acuity
 environments as well as in other healthcare contexts. The IHE PCD SDPi profiles proposed in
 this document likewise are primarily intended for device-to-device interoperability in medical
 care contexts where patients are in their most critical and vulnerable condition; however, they
 475 may also be utilized in other contexts as appropriate.

4.3 Document Organization, Conventions & Abbreviations

The document builds on general aspects of medical device interoperability up to specific proposals for how SDPi should be integrated into both the IHE PCD Technical Framework as well as IHE testing, from connectathons to product certification. It is organized as follows:

480

[MD Interoperability](#)

Short introduction to aspects of medical device interoperability that are key to establishing a common reference point for all readers of the subsequent material.

⁷ Source: IEEE 11073-10207:2017, Figure 5, section 5.3.7 SystemContext.

485	SDPi Scope, Purpose, ...	Level setting for the proposed SDC profiles and specifications to be integrated into the IHE PCD technical framework – what it covers and what is out-of-scope.
	DPI Overview	A few general concepts regarding device point-of-care interoperability, building on MDI above.
490	IHE Process Backgrounder	Overview of IHE lifecycle processes for those unfamiliar with IHE in general.
	IHE PCD Backgrounder	More focused introduction to the interoperability profiles established in the IHE Patient Care Device (PCD) work group.
495	SDC Backgrounder	Overview information for SDC, including the core architecture, IEEE 11073 standards, future development, etc.
500	Core Considerations	Additional set of topics that will be addressed in mapping SDC technologies into the IHE PCD Technical Framework but that do not fit into the preceding topics (yeah, a bag of extra stuff).
	SDPi Proposed Integration	Recommendations for integrating SDC into the IHE PCD TF, from the general approach to specific profiles, profile options, and other testing.
505	IHE Domain Coordination	Though the focus of the SDPi proposal is in the PCD domain, other IHE domains have scope and profile specifications that are relevant (e.g., surgery).
510	Roadmap & Timeline	Proposed plan for profile development, testing, demonstrating and product certification, starting with basic SDC-based interoperability and reporting functions, to alerting and external control.
	Appendices	Various appendices are provided with additional reference detail, in order to declutter the main content of the document.

515 The following editorial conventions and assumptions are used in this white paper:

1. General references have been provided in **Appendix B – Bibliography**, but the majority of the information referenced in this document is accessible at:
 - ✓ IHE PCD SDC@IHE wiki (<https://wiki.ihe.net/index.php/SDC@IHE>)
 - ✓ IHE Tech Publications (www.ihe.net/resources/technical_frameworks/)

- 520 2. **Working Definitions:** A [Glossary appendix](#) is provided with some general definitions that may be new to IHE technical frameworks, as well as per the abbreviations below, but they are intended to be “working” definitions with more precise, standardized definitions being referenced when appropriate. No pedantry here, please!
- 525 3. **Medical vs. Healthcare:** This document assumes the generally understood meaning of “medical” as that which is concerned with the diagnosis, treatment and management of disease. This is a subset of the more general meaning of “health” such as an electronic health record (EHR). This document will use medical technology to address regulated devices, systems and applications for which SDC is tailored to integration. Health and healthcare will be used to more generally describe technology and use contexts of which
- 530 medical is a part (e.g., laboratory, imaging, administration, etc.).
- 535 4. **Devices vs. Systems vs. Apps:** In this document these terms are used in a general “person on the street” understanding, though anyone who has been involved in regulated medical technology will be familiar with very precise, legal definitions delineating what is a device, a health device, a medical device, Software as a Medical Device (SAMd), systems, health application software, “apps” used on general purpose hardware or platforms, sometimes for health management and sometimes for medical care delivery, etc. As mentioned above, though important to understand the distinctions and their roots in established international standards (e.g., ISO 14971, ISO 62304, IEC 80001-1, etc.) it is not core to the scope of this document. SDC does clearly address the implementation and regulatory requirements as established in the high-acuity MDI arena, but those
- 540 detailed considerations will be addressed in subsequent documents and specifications.
- 545 5. **Generic use of “Device” & “System” & “Application” vs. Participant:** In general, though, sometimes for readability, reduction in redundancy, etc., device or system or application or app, etc., will be used in a generic sense, often in place of the more formal “PARTICIPANT”, defined⁸ as:
- Any network node that is part of a SERVICE-ORIENTED MEDICAL DEVICE SYSTEM (SOMDS) and exchanges information by means of a service-oriented architecture. A PARTICIPANT can be either a SERVICE PROVIDER or a SERVICE CONSUMER.*
- 550 Or “SDC Participant” defined⁹ as:
- PARTICIPANT that adheres to the requirements of this specification, IEEE Std 11073-20701.*
- The reader will be provided the opportunity to sort it all out. Pedantry wasted here.
- 555 6. **Point-of-Care (PoC):** Yeah, using hyphens in this document.
7. **“High-Acuity”:** Think patients in hospitals. OR, ICU, emergency, etc.

⁸ See IEEE 11073-20701:2018 section 3.1 *Definitions*.

⁹ See IEEE 11073-20701:2018 section 3.1 *Definitions*.

8. **“Profile”**: Another very overloaded term; in this document it is used in the generic sense of a “set of constrained standards specifications” when it is used alone; “IHE Profile” is a specialized term that is used for a component interoperability specification in an IHE Technical Framework (e.g., ACM Profile) – *SDPi is an “IHE Profile”*; *FHIR profile* refers to a specific set of constraints (typically specified using a StructureDefinition) in the HL7[®] FHIR[®] Standard and formalized in a FHIR Implementation Guide.
9. **Nomenclature vs. Terminology**: Yet another very overloaded set of ... vocabulary. In this document, they will be used interchangeably, though some make very clear technical distinctions between ... ontological concepts! ... in this space; some equate “nomenclature” solely with identifying types of devices (e.g., ventilator or LVP infusion pump, such as GMDN or UMDNS); whereas, others take a broader view of nomenclature including the formalized naming of all concepts related to a specific subject area or use; again, herein nomenclature and terminology are used interchangeably.
10. **All Caps Phrases**: Per formal standards style guidelines, when a term or phrase is in all caps (e.g., “CLINICAL WORKPLACE”) that means it is a formal, normative “defined term” in a standard; when used in this document, the style convention will be maintained along with (generally) providing the definition text and source standard & section.
11. **Figure Sources**: Unless otherwise specified, assume that all graphics and figures contained in the document are sourced from the general SDC presentations referenced in the Bibliography.

Common abbreviations include:

560	BICEPS	Basic Integrated Clinical Environment Protocol Specification; shorthand for IEEE 11073-10207:2017.
580	DIM	Domain Information Model; defined in IEEE 11073-10201:2004 as “The model describing common concepts and relationships for a problem domain”; this includes standardized models for device parameters (physiological and technical), as well as alerting and external control; see Section 8.6 <i>Semantic Model: From Nomenclature to Information Models</i> .
585	DPI	Device PoC Interoperability; used generically for PoCD connectivity as well as in reference to the originally proposed (2009) IHE PCD DPI profiles.
590	MDIB	Medical Data Information Base; defined in IEEE 11073-10201; see 8.2 and 8.6 for additional information.
590	MDPWS	Medical Device Profile for Web Services; shorthand for IEEE 11073-20702:2016.
	NIST	National Institute of Standards & Technology, part of the U.S. Department of Commerce. See Information Technology Lab / Software & Systems Division / Systems Interoperability Group .
	PCD	IHE Patient Care Device “domain” or working group.

595	PHD	Personal Health Device; typically used in non-acute, non-medical and non-high-acuity care contexts (e.g., home).
	PoC	Point-of-Care, same as in PoCD for “device”; often used to differentiate with PHD or imaging devices that are typically not deployed at a high-acuity patient bedside.
600	SDC	Service-oriented Device Connectivity; used herein to refer to the entire SDC family of IEEE 11073 standards and all systems, devices and applications that implement SDC-enabled interoperability.
	SDPi	Service-oriented Device Point-of-care Interoperability; working title for the proposed profiles and specifications for the IHE PCD TF.
605	SOA	Service Oriented Architecture; See <i>Appendix B – Bibliography</i> for references.
	SOMDA	Service Oriented Medical Device Architecture; shorthand for IEEE 11073-20701:2018.
610	SOMDS	Service Oriented Medical Device System; an implementation “instance” of an SDC-based network as defined in SOMDA.
	TF-x	IHE Technical Framework volume <x>, where “x” is 1-4.

5.0 “DPI” Device-to-Device Interoperability Overview

615 SDC is rooted in a rich decades long effort to establish open standards-based device point-of-
care interoperability (DPI) solutions. Many of the requirements that drove the capabilities
contained in SDC standards and solutions – both functional and non-functional – can be traced
back to hard learned lessons, which in the case of the IEEE 11073 standards family, started in the
early 80’s and with cross-functional working groups that spanned continents! The DPI
620 challenges have not changed appreciably, even though technology has evolved generationally
every 5-10 years – now in the 4th Industrial Revolution with integrated real-time AI and machine
learning, robotics and autonomous cyber-physical systems, real-time analytics and
micro(medical)-services, to name a few. The use case examples below along with those
enumerated in *Appendix D – Compendium of Medical Device Oriented Use Cases* illustrate some
of the real-world DPI applications that identify the challenges and establish the requirements
625 foundation upon which standards and their implementation are based.

As has often been asked, “Why not just use HL7 v2 or HL7 FHIR in the device interface?” In
some cases, this may be a viable alternative; however, the design requirements associated with
high-acuity DPI “from the device interface” applications were not considered when enterprise-
facing standards were crafted and implemented. This section reviews some of the unique DPI
630 aspects that *any* solution must address – both technical and business – as well as some of the
potential misunderstandings that can arise from terms used multiple application contexts. Note
that these topics are not comprehensive, but they do help understand what is unique about DPI
vs. other areas healthcare interoperability.

Patient Safety is Job #1

635 For medical devices and thus DPI especially in high-acuity environments, if the device itself as
well as its role in the overall connected system of devices and applications, does not perform as
expected real safety risks can result. In the case of ventilators, infusion pumps and similar, they
can result in permanent injury or even death. Therefore, even though healthcare quality including
patient safety is an important aspect of all digital health solutions, in the case of DPI it is of the
640 highest priority. Recognizing and managing the risks associated with DPI thus becomes a key
driver of the requirements and capabilities of any connected solution, including the features of
SDC-based connectivity. Proving to regional regulatory authorities that the DPI solutions
implemented into a given product are safe, effective and secure becomes THE barrier to market
entry that must be navigated, and ensuring this over time (years of use in clinical contexts) is
645 business-critical for any product developer, not to mention patients and their caregivers!

Connectivity: Device-to-Device, Device-to-Patient

The word “connectivity” and “connected” are often overloaded, and in the case of medical
device technology can mean direct connection to a patient or connection to device-external
computers and application. For clinical staff, patient “connected” implies a physical attachment,

650 whether or not the device has a computer communications interface.¹⁰ Also, DPI may focus on
device-to-manager (or network controller / supervisor) communication, or it may focus on direct
device-to-device interoperability with no intermediary. Though either architectural approach is
valid, each comes with their own set of risk factors that must be assessed and mitigated. Specific
risk mitigation capabilities are thus included in any DPI solution.

655 **Device Resource Constraints**

Most medical devices are designed with “embedded” platform technology. This limits the
resources that are available for processing, memory, communication bandwidth, etc. As a result,
DPI must include the ability to be implemented in highly constrained, embedded computing
environments. This is typically not the case for other protocols that are implemented at the
660 enterprise level where processing power, memory, communication technology and bandwidth
can be easily scaled as necessary. In some cases, “canned messaging” is implemented, where
pre-formed message templates are used, allowing the device to simply plug in the dynamic
information and send the message. This is also the rationale for “binary” protocols over human-
readable text-based protocols, the former generally requiring lower resource overhead in terms of
665 processor bandwidth, memory consumption and even communication channel bandwidth.

“Hard” Real-time at Clinician Speed!

DPI must address “hard” real-time requirements. In this case, “hard” means “if you don’t meet a
deadline then really bad things can happen!” Sometimes this is formalized in law, such as the
670 maximum time allowed between the on-set of an asystole condition in a patient and when it is
announced at the device to clinical staff. This 10-second maximum time period does not start
from when the device sensor first recognizes the heartbeat pattern but from when the condition
starts physiologically. In the case of DPI and even distributed algorithms, mechanisms must be in
place to ensure the system can respond as required – Safely, Effectively & Securely.

Another example is a physician at an OR table, looking at a consolidated dashboard or heads-up
675 display with data sourced from multiple devices around the point-of-care. There should be little
noticeable delay from what is on the front of the device itself vs. what is on the display, and the
display must time synchronize between all data sources to ensure proper alignment.

A final example would be robotics and hand-eye control of one or more medical devices during
surgery. “Hard” real-time? Absolutely.

680 **External Device Control, Closed-loop, Autonomous Systems – How hard can that be?**

Control of a device by an external system or application has been a challenge for DPI from the
very earliest days. External control ranges from the relatively low-risk pausing of alarm audio for
a minute until a clinician arrives, to adjusting a breath rate on a ventilator or a drug rate on an
infusion pump. In the case of infusion pumps, regulators often allow external modification of

¹⁰ Other terms that are frequently misunderstood include “implementation” and “standalone”, as well as others. This is a key aspect of the ISO 81001-1 standard in development to establish the meaning for a given term depending on how it is used, both in other standards as well as system development and use.

685 infusion parameters, albeit leveraging proprietary protocols, but require a clinician to actually press the “go” key.

DPI solutions can implement “reporting” only functionality, or reporting + alerting, but omit any ability to allow an external system to change the internal state of a device. Supporting PnP device-external control, however, is a must for any DPI standards solution given the innovative technologies being developed.

690 From a difficulty perspective, real-time control systems in safety critical environments have been implemented for decades, especially in avionics or industrial control / automation. This has proven a persistent challenge in high acuity healthcare, though. Closed-loop control (CLC) and even autonomous medical device systems are increasingly being considered, but DPI solutions that address the regulatory challenges must be factored in so as to allow component solutions to be developed and deployed with confidence.

Technology Evolution & Innovation & Safety: Maintaining Balance

700 As stated above, all industries are experiencing a sea change in technology and this is being applied to high acuity medical care solutions as well. These include the moving of intelligence either closer to the sensor or into cloud-based systems (where scaling resources is much easier). They include leveraging real-time analytics and decision support, artificial intelligence / machine learning, virtual/mixed/augmented reality, IoT connectivity, robotics and autonomous systems ... the list goes on. To be able to take advantage of and accelerate the adoption and use of these technologies, any DPI solution must support connectivity across all levels of interoperability (e.g., technical, semantic, pragmatic), enabling innovation at the highest-levels including clinical algorithms.

705 That said, balance must be maintained between advancing innovative DPI-enabled solutions and ensuring safety and effectiveness. This was the focus of the U.S. FDASIA effort between the FCC, FDA and HHS/ONC departments.

710 Regulatory Science Challenges

715 Related to the use of emerging knowledge-based technologies in high-acuity healthcare delivery is the challenge that regulatory authorities have in assessing the potential sources of safety risk and the mitigations that might be deployed to ensure that a given technology is “safe enough” to be deployed. In the case of DPI solutions, this challenge is extended to understand how a component of a PnP connected system-of-systems can be cleared for market with a high-level of confidence that any foreseeable unintended consequences have and will be mitigated when placed into use. This is especially the case with AI/ML systems, as evidenced by the U.S. FDA’s “pre-cert” program.¹¹

720 Another DPI example is identifying risk responsibility in systems where various components, some medical devices, some applications and some remote services (e.g., sepsis assessment on a

¹¹ See <https://www.fda.gov/medical-devices/digital-health/digital-health-software-precertification-pre-cert-program>.

given patient data set), are combined to provide an innovative solution beyond the scope of use anticipated by any one of the component developers.

725 And this is not legal responsibility but identifying who will do the work of establishing and maintaining the safe, effective and secure implementation and use of these systems. DPI technology can address the communication nuts-and-bolts part of the problem; however, any deployment must include a medical IT network risk management program.¹²

Device “Modalities” vs. Use Contexts: Semantics & Pragmatics

730 Device modalities (e.g., physiological monitor, infusion pump, ventilator, endoscope, etc.) combine a set of sensor and actuator technologies, along with user interfaces and informatics components that may be the same or may change depending on the use context. For example, an infusion pump may be designed for use in an OR, in an emergency room, in home care, and even in space! For all of these, though, the abstract semantics remain fairly constant while the physical technology and user interface are tailored more for their intended use context. Any DPI solution must both provide the unique set of capabilities required for its use context while
735 maximizing interoperability at the semantic and pragmatic levels, supporting cross use context applications.

Two of the examples provided later in this document highlight this requirement of DPI to work with other interoperability solutions across use contexts, especially when semantic interoperability is critical (e.g., care coordination and decision support).

740 DPI is a Business Problem, not a Technical Problem

Given all of the above (and more), it is often said: *Medical device interoperability is a business problem, not a technical problem.*

745 To be sure, over the decades many technical solutions have been demonstrated, standards developed and published, even product solutions put into production and put into use with patients; however, today the reality is that DPI “from the device interface” remains almost completely absent from the marketplace. This is in stark difference to what is being seen in other areas of healthcare interoperability, for example, with the increased use of HL7 FHIR. Why is DPI so different?

750 To understand this, the West Health Institute commissioned research¹³ in 2015 to determine the business drivers for medical device interoperability (MDI), who pays and who reaps the benefits and what is the cost to the U.S. healthcare industry by not having out-of-the-box PnP DPI. The results can be summarized as follows:

- ✓ Over \$30B / year is lost to the U.S. healthcare industry due to the lack of MDI

¹² See IEC 80001-1:2010.

¹³ See <https://www.westhealth.org/wp-content/uploads/2015/02/The-Value-of-Medical-Device-Interoperability.pdf>.

- 755
- ✓ Medical device vendors have almost no value (increased \$\$\$) derived from changing their current connectivity solutions to use interoperable standards-based solutions.
 - ✓ Healthcare providers bear the vast majority of the loss due to inefficiency and quality challenges.

760 SDC represents another opportunity to address the DPI “from the device interface” challenge: both technical and business. IHE PCD SDPi is a crucial step in rising to that challenge; however, it must factor the challenges identified above and deliver interoperable solutions to healthcare providers. This, of course, is the vision and mission of **IHE**:¹⁴

Vision: *Enable seamless and secure access to health information that is usable whenever and wherever needed.*

765 **Mission:** *IHE improves healthcare by providing specifications, tools and services for interoperability. IHE engages clinicians, health authorities, industry, and users to develop, test, and implement standards-based solutions to **vital** health information **needs**.*

¹⁴ See www.ihe.net/about_ihe/ as well as www.ihe.net/2020vision/.

6.0 IHE Process

770 Integrating the Healthcare Enterprise (IHE) is an International non-profit organization established over 20 years ago that is dedicated to bridging the gaps that exist between healthcare providers and clinicians, along with their patients, and the standards and standards-based solutions that are made available on the market. Since its creation, IHE International has grown to over 200 organizational members, and includes national and regional groups from Europe to Asia. This section provides a general overview of IHE for those who may not be familiar either

775 with the organization, its processes and technical framework specifications.

See www.IHE.net for more comprehensive, up-to-date information.

6.1 Big Picture

780 As the IHE vision and mission statements above indicate, the IHE process is to start with real-world “needs”, expressed by detailed use case stories, followed by the development of standards-based technical solutions that can be productized and implemented to achieve the anticipated improvements in healthcare safety, quality, and efficiency. *Figure 2* illustrates this high-level IHE process:

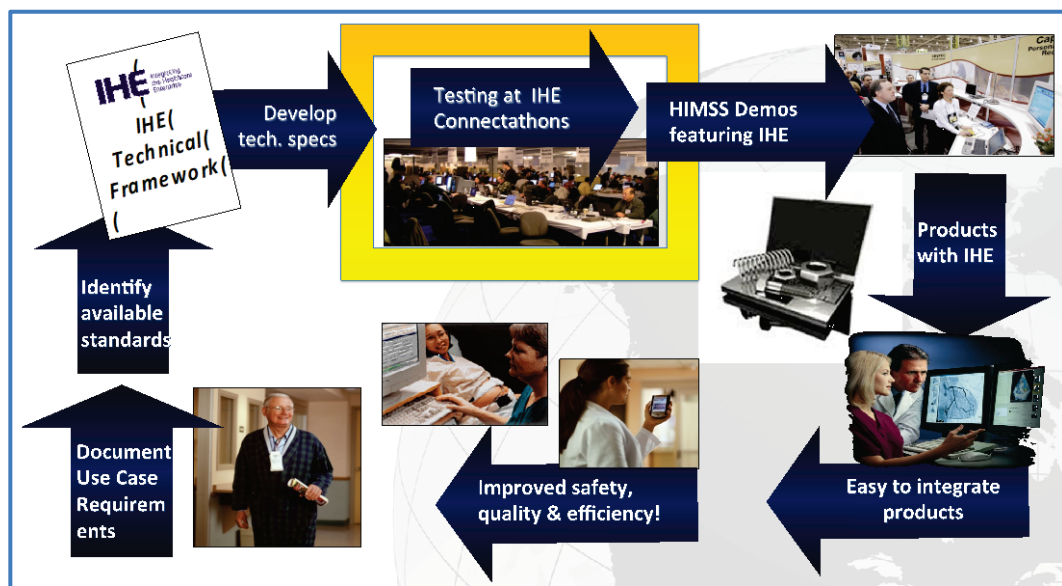

785 *Figure 2 IHE Process: From Standards to Products to Improved Healthcare*

Creating technical specifications are not sufficient, though, to effect change at the point-of-care – all healthcare ecosystem stakeholders must work together in a coordinated business model that results in implementable, interoperable products, as shown in *Figure 3*.

790

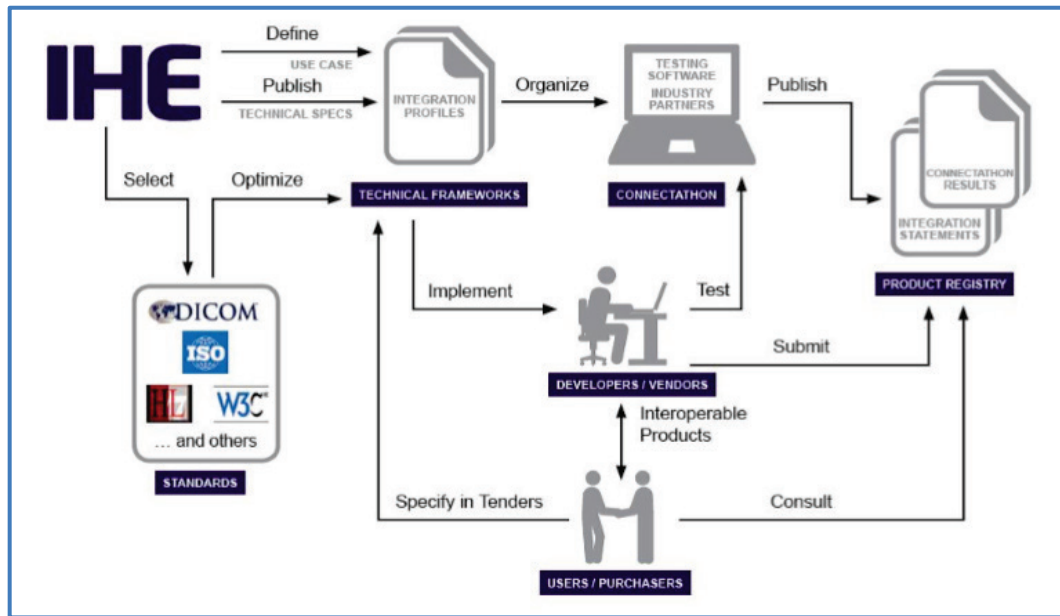

Figure 3 IHE Process: Connecting Healthcare Technology Stakeholders¹⁵

795 Key to the above figure is bridging the gap between what users / purchasers can put in their
 tenders regarding interoperable technology, and the actual products that are available in the
 market to meet their needs. From a vendor perspective, as detailed above, with a [focus on the](#)
[medical device DPI marketplace](#), given all the possible capabilities expressed by healthcare
 providers, coupled with the need to balance the cost of implementing interoperability vs. the
 potential revenue to be realized, the IHE process connects product developers with
 800 user/purchaser stakeholders so as to ensure that products with IHE conformant capabilities will
 be included in subsequent requests.

6.2 Global Community

IHE International is a global community, as detailed in *Figure 4* below.

¹⁵ See www.ihe.net/about_ihe/ihe_process/.

IHE Asia-Oceania	IHE Europe	IHE North America	South America	Middle East
Australia China Japan Korea Taiwan	Austria Finland France Germany Italy Spain Switzerland The Netherlands Turkey Luxembourg United Kingdom	Canada U.S.A.	Brazil Colombia	Saudi Arabia

Figure 4 IHE National & Regional Deployment Committees¹⁶

805 Whereas the standards-based technical frameworks identified in *Figure 3* are developed to meet international needs, it is recognized that actual implementation and use of IHE conformant products is rooted in the public and private socio-economic ecosystem of each community. As a result, IHE International includes a robust group of geographic-based deployment committees, that are responsible for:

- 810
1. Ensuring that the internationalized technical specifications meet their community needs
 2. Participating in technical framework “profile” development, including the creation of Volume 4 National Extensions, when appropriate
 3. Conducting national / regional testing, demonstration and educational events

815 A part of IHE’s participation in the international health informatics standards community, includes the publication in ISO/TC 215 Health Informatics of three technical reports (TR) that describe the IHE process in detail and in a manner that can be easily recognized and adopted by governments and international agencies: *ISO/TR 28380 Health Informatics – IHE Global Standards Adoption* —

Part 1: Process

820 *Part 2: Integration and Content Profiles*

Part 3: Deployment

This is further illustrated below in *Figure 5 IHE Global vs. Regional Development*.

6.3 Domains & Technical Frameworks

825 As depicted in *Figure 5*, IHE International is composed of a board and then a set of subject area-specific “domains” and regional/national deployment committees.

¹⁶ Source: www.ihe.net/about_ihe/governance/. (Accessed 2019.07.26)

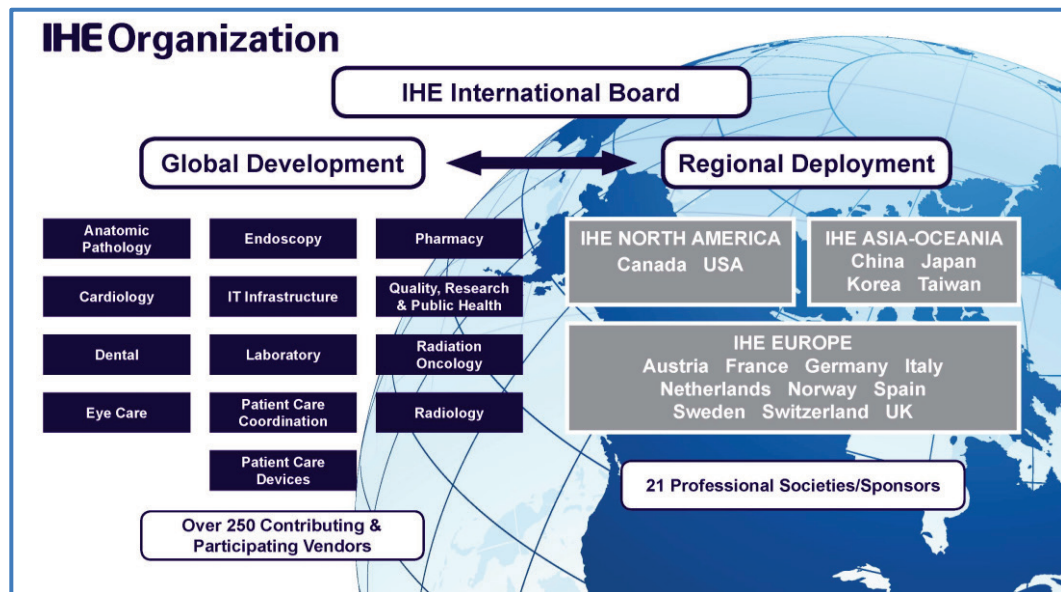

Figure 5 IHE Global vs. Regional Development¹⁷

830 IHE technical framework specifications are developed globally by domain committees such as IT
 Infrastructure, Radiology and Patient Care Devices; whereas, deployment is managed regionally
 as indicated on the right side of the graphic. It should be noted that though vendors are actively
 involved in the IHE process (as mentioned in Section 6.1 above), the actual funding of the
 domain and deployment committee activities is accomplished via non-profit and public sponsors
 835 such as professional societies, thus ensuring the integrity of the overall process execution.

Domains are composed of two committees:¹⁸

Planning Committee: Responsible for managing the profiles that are addressed within the domain’s TF, including connection with healthcare providers and clinical stakeholders.

840 **Technical Committee:** Responsible for developing the detailed technical specifications, especially in TF Volume 2.

Domains are responsible for the development of technical framework specifications within the scope of their area. IHE technical frameworks are divided into three “volumes”:

¹⁷ Note: the specific domains and regions/nations on this diagram may not be current. See www.IHE.net for the latest information on these as well as organizational membership.

¹⁸ See www.ihe.net/participate/ihe_committees/ and <https://wiki.ihe.net/index.php/Committees> for more information.

845 **TF-1 Interoperability Profiles**¹⁹ High-level specification of how a specific interoperability need (as expressed in use cases) will be addressed, including the actors, transactions, semantic content and standards to be utilized.

TF-2 Transactions Detailed technical specifications for each exchange between two or more actors, and potentially across multiple profiles.

850 **TF-3 Semantic Content** Terminology, nomenclature, value sets that support semantic interoperability across and intent of transactions and profiles.

As mentioned above, a TF-4 may also be included when national extensions are defined for a given profile. For example, a specification may require a patient identifier (PID) and may even reference a specific standard such as HL7 FHIR Patient resources; however, a national deployment of that could add specifications as to the exact form and source of the PID.

855 Though the domain Technical Committee is responsible for standards selection and detailed technical specifications, the Planning Committee retains general oversight on all volumes of the technical framework, managing the overall process path as illustrated in *Figure 2*.

6.4 Interoperability Testing Events

860 Once technical framework specifications are completed and ready for “trial implementation”, IHE conducts various testing events including plug-a-thons (PAT), connectathons (CAT), which demonstrate an organization’s ability to implement a specific profile, conformity assessment (CA) testing for specific product make/model conformity leading to product certification, to projectathons that focus on specific deployment projects that integrate IHE-enabled products as well as other technologies to realize interoperability in real-world use. Subsequent sections
865 address both projectathons as well as conformity assessment, but this section overviews the first two components:

870 **IHE Connectathons** These testing events bring together vendors who have prototyped IHE profiles to verify their ability to work together (see *Figure 11*). These events are held regularly around the world and are managed by national & regional deployment committees. Each event leverages the same core test tooling and profile-specific test scripts to ensure international continuity. Also, all testing is monitored and “graded” by independent personnel, often those from a domain’s Planning Committee or those who work in the field and have a good understanding of the interoperability need that a given profile is intended to address.

875 **IHE Plug-a-thons** At times, there is value in pulling together individuals who are interested in specific interoperability problems or emerging technologies, to identify “profile” opportunities and approaches, as well as build a community to advance that within one or more IHE domain committees. These “PAT” events may be held in

¹⁹ “Profiles” and profiling generally refers to the selection and constraint (removal of options) of standards and specifications. Think of nose and chin as part of a person’s face, but then a “profile” that includes the specific outline of an individual’s ... facial profile.

880 conjunction with established IHE Connectathons or may be at other times as opportunity
 arises to bring together digital health experts with innovators wanting to enter that space.
 In some cases, an IHE community exists that is in the process of developing a profile
 specification – has even published a “trial implementation” version – but lacks sufficient
 numbers to conduct a formal IHE profile interoperability test (requires at least 3 sending
 and 3 receiving actor pairs). In this case, a PAT could be used to advance profile
 885 development.

The following *Figure 6* illustrates a typical IHE PAT event.

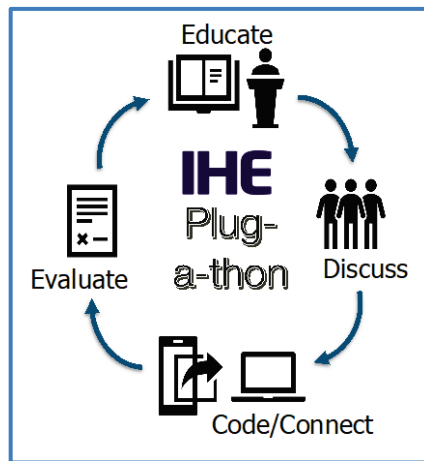

Figure 6 IHE Plug-a-thon Process²⁰

890

Although there is no formal IHE PAT program, it has proved effective in recent years in
 advancing discussion around topics such as Devices on FHIR, blockchain and IoT. See *Figure 7*
 for additional perspective.

895 Note that in the case of SDC and IHE SDPi, PAT events may prove useful in testing out specific
 aspects of the profiles as well as building community and understanding around the world.

6.5 Conformity Assessment & Product Certification

900 As mentioned above, IHE Connectathons (CAT) support interoperability testing around a
 developer’s ability to implement IHE profile capabilities. This is not tied to a specific product,
 though, and does not include the level of rigor that is necessary to ensure that a product (make
 and model) will be IHE interoperable out-of-the-box. The relationship between IHE PAT, CAT
 and CA is illustrated below in *Figure 7*.

²⁰ As presented by John Donnelly in the HIMSS’18 Interoperability Showcase.

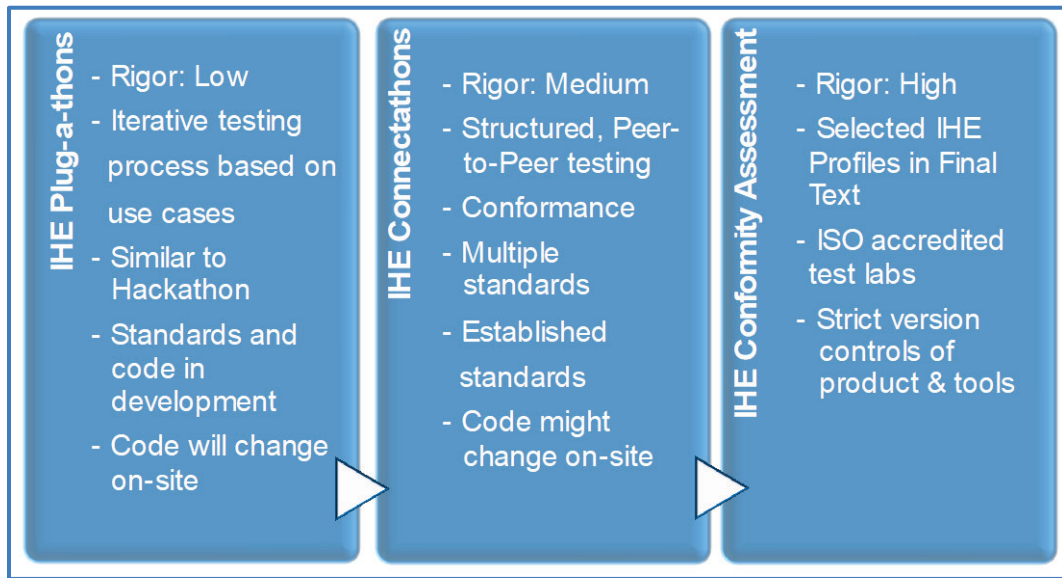

Figure 7 IHE PAT to CAT to CA - Increasing Conformity Rigor²⁰

905 IHE International supports a global CA program that leads to product certification. The program is aligned with international certification standards (e.g., ISO 17000 series) and oversight bodies. See www.ihe.net/testing/conformity-assessment/ for full detailed information.

6.6 Public Demonstrations, Projectathons, ...

910 “Seeing is believing ...” especially given the decades of broken promises to healthcare providers around the value proposition of open standards-based interoperability, namely, to improve healthcare safety, quality and efficiency. IHE deployment committees regularly conduct public demonstrations to showcase products that have implemented IHE-based connectivity and can be used by care providers today. In other words, the final parts of the IHE process depicted in *Figure 2*. These are “live” demonstrations, not “canned”, that help build confidence throughout the ecosystem that standards-based interoperability is real and is available now.

915 The next step, though, is to conduct integration eHealth Projects either in a single hospital or throughout a region and cross-region, as depicted in *Figure 8*.

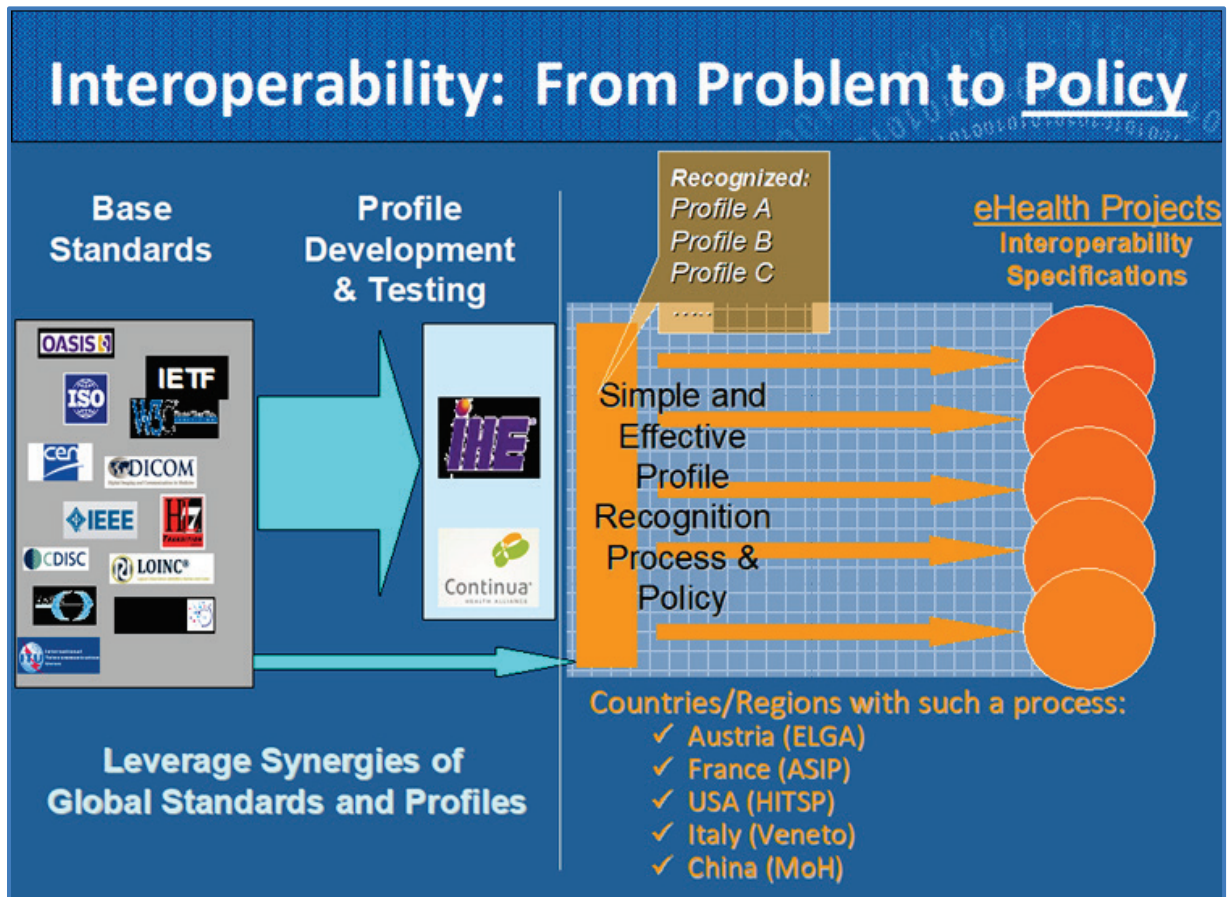

Figure 8 IHE @ Public eHealth Projects & Projectathons²¹

920 Though many organizations and public agencies have a tendency to “reinvent the wheel”, IHE in
 925 coordination with other Standards Development Organizations (SDO) provides an efficient,
 proven method for matching a project’s interoperability needs with established IHE profiles,
 greatly reducing the time, effort and cost required to complete policy adoption and
 implementation. Projectathons are not currently a formal part of the IHE process; however, the
 global IHE community provides the support to facilitate adoption and effective use of these
 technical framework specifications.

²¹ Note that the current “Countries/Regions” that have active IHE-based eHealth projects can be reviewed at www.IHE.net.

7.0 IHE PCD “Device” Technical Framework

930 The IHE PCD technical framework and domain activities conforms to the general process detailed in the previous Section 6 *IHE Process*, with the scope being on healthcare devices that are generally deployed in high-acuity environments. This section is provided for those who may have a general understanding of IHE but need a more detailed overview before moving on to Section 10 *SDPi: Integrating SDC into IHE Technical Frameworks* that provides details around how SDC-based interoperability might be integrated into the IHE PCD technical framework.

935 7.1 IHE PCD Domain Overview

The IHE PCD domain was formed in 2005 with the following scope:

The Patient Care Device Domain is concerned with use cases in which at least one actor is a regulated patient-centric point-of-care medical device that communicates with at least one other actor such as a medical device or information system.

940 Excluded from this scope are medical device technologies that are addressed in other IHE domains such as Radiology or Cardiology. The domain is sponsored by the American College of Clinical Engineering (ACCE), the Health Information Management Systems Society (HIMSS), and the Association for the Advancement of Medical Instrumentation (AAMI).

945 The primary focus of PCD’s work has been on the integration of device reported information into enterprise level applications, such as electronic health records (EHR) and clinical flowsheet applications. Device-sourced alert management distributed to the enterprise has also been implemented; however, in the case of both reporting and alerting, the connection to the actual device has remained out-of-scope for PCD profile development and continues to be dominated by vendor-specific, proprietary communication protocols, as detailed above.

950 Device control, either from enterprise-based applications or other point-of-care devices, has remained completely out-of-scope for PCD’s technical framework development activities.

955 Note that though a point-of-care “from the device interface” effort was launched around 2009, the Device Point-of-care Integration (DPI) profiles, it lacked sufficient community and resources to complete the proposed TF DPI supplements and proceed to CAT testing. The proposed SDPi profiling picks up that ball and moves forward leveraging the SDC standards and support technology.

General domain information is available at:

www.ihe.net/ihe_domains/patient_care_devices/

and

960 https://wiki.ihe.net/index.php/Patient_Care_Device

The remainder of this section addresses key aspects of PCD’s work to date, especially as it bears on the integration of SDC. More detailed background is provided in the appendices, as referenced below.

7.2 Standards-based Technical Approach

965 Given the focus on the integration of device reported content at the enterprise level, all of the current PCD profiles are based on the following technical approach:

1. Semantic content based on IEEE 11073-1010x nomenclature and 11073-10201 domain information model;
2. HL7 v2 “ORU” messaging
- 970 3. HL7 “MLLP” and (optionally) ITI WS-* transport specifications

The historic reason for this is simple enough: The first profile, reporting Device-to-Enterprise Communication (DEC), leveraged the fact that almost every device vendor had a gateway product that implemented HL7 v2 messaging, albeit in a slightly different manner. Gaining consensus on a common HL7 v2 ORU^R01 message profile, mapping device information content from the 11073-10201 specification to HL7 v2 message “segments” was fairly straightforward; however, mapping vendor proprietary semantics (terminology and nomenclature) was a different matter altogether.

975 The PCD domain launched the Rosetta Terminology Management (RTM) initiative to provide a consistent mapping from vendor-specific semantics to standardized 11073-1010x nomenclature, and then creating a “harmonized” value set that established the basis for standardization of semantic content at the enterprise level. See Section C.7 *PCD Profile: Rosetta Terminology Mapping (RTM)* for more information on RTM, and Section 7.4.2 *Proposed NIST Framework Integrating SDPi Support* for information on the NIST RTMMS support tooling.

7.3 PCD Core Interoperability Profiles

985 Details of the IHE PCD interoperability profiles are contained in *Appendix C – IHE Enterprise Facing Connectivity Profiles*, but the core profiles that SDPi will “gateway” with for enterprise integration, may be summarized as follows (in alphabetic order):²²

[ACM Alert Communication Management](#)

990 *Enables the remote communication of point-of-care medical device alert conditions ensuring the right alert with the right priority to the right individuals with the right content (e.g., evidentiary data). It also supports alarm escalation or confirmation based on dissemination status, such as whether the intended clinician has received and acknowledged the condition.*

[DEC Device-to-Enterprise Communication](#)

995 *Supports publication of information acquired from point-of-care medical devices to applications such as clinical information systems and electronic health record systems, using a consistent messaging format and device semantic content.*

²² Source of description summaries: www.ihe.net/ihe_domains/patient_care_devices/.

WCM Waveform Content Management (DEC option)

1000 *Extends the DEC Profile to provide a method for passing near real-time waveform data using HL7 v2 observation messages. For example, passing wave snippets as evidentiary data in an alarm message communicated using ACM transactions.*

IPEC Infusion Pump Event Communication

1005 *Allows an infusion system to send detailed non-alarm information on to allow the tracking and logging of the whole history of an infusion operation.*

PCIM Point-of-Care Identity Management

1010 *Assist in the reliable association of device reported data to the proper patient record, based on first-hand observation and data entry by a person at the point of care, specifically designed to avoid wrong attribution of data from before or after the period of actual measurement on the patient. Also, to assist in maintaining a correct “census” of devices that frequently move between patients such as infusion pumps, and mechanical ventilators.*

PIV Point-of-care Infusion Verification

1015 *Supports communication of a 5-Rights validated medication delivery / infusion order from a BCMA system to an infusion pump or pump management system, thus “closing the loop.” Optionally, the DEC Profile may be used to selectively monitor the status of the devices that have been programmed.*

In addition to the detailed profile specifications linked to above, all of the technical framework specifications can be downloaded at www.ihe.net/resources/technical_frameworks/.

7.4 Tooling, Connectathons, Demonstrations, Products

1020 As mentioned above, IHE provides a robust set of test tooling that is used at testing events such as IHE Connectathons, to validate conformity to technical framework specifications. In the case of IHE PCD, the domain has regularly participated in IHE CAT events and demonstrations since 2006 and uses a set of tools provided by NIST in particular. Since current PCD profiles are based on HL7 v2 messaging, the established tool set from NIST provides the needed services. When
1025 considering the integration of non-HL7v2 SDC / SDPi implementations, the current tooling needs to be leveraged but extended appropriately.

1030 Additionally, given the intent to address the regulatory submission needs for SDC conformant technology, the tooling approach needs to be sufficient to trace intended use and risk management mitigations during the test process and generate reports that can be included as part of a regulatory submission. Section 7.4.3 *Evolving SDC Community Tooling* below specifically addresses this requirement.

1035 Finally, SDC-based IHE profiles are intended to also integrate with enterprise-based systems, including interoperating with the IHE PCD profiles detailed above. Therefore, the test and tooling strategy must enable end-to-end verification between the SDC participant device and whatever application and system wherever that consumes its data and services.

The final objective of this SDC@IHE initiative is to leverage maximally existing IHE and IHE PCD processes, specifications, tooling, test events, demonstrations etc. leading to interoperable products in high-acuity point-of-care environments.

7.4.1 General IHE Test & Tooling

1040 IHE Connectathon (CAT) testing events have included tooling that not only support CAT
management – the Gazelle CAT management tool – but also many of the IHE profile-specific
conformity testing tools as well. NIST has played a key role in the development of testing and
tools frameworks that are used not only in IHE connectathons but also in the certification of
1045 actual products, as well as “projectathons”, which are testing events for specific implementation
projects.

As illustrated in *Figure 9*, the NIST tooling framework for HL7-based system validation includes:

IGAMT Implementation Guide Authoring Management Tool

TCAMT Test Case Authoring Management Tool

1050 By minimizing the number of times individuals are involved – as “single source of truth” authors
– the end tests can be performed using generated artifacts that ensure connection to the original
standards and profile specifications. Since all the NIST tools are in the public domain, they are
not only available for IHE CAT testing but open for broad adoption and use around the world.

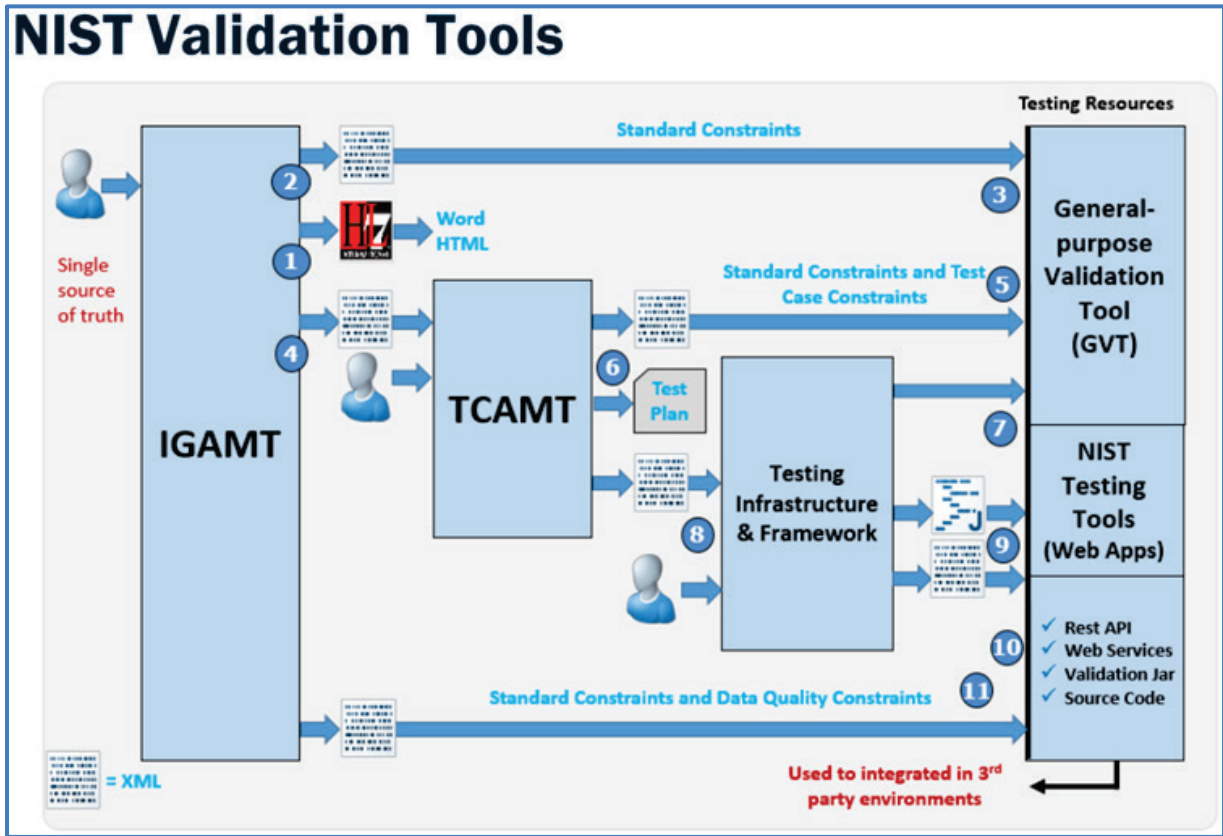

1055

Figure 9 NIST Validation Tooling Framework

1060

Figure 10 illustrates that this tooling is also not only focused on conformity testing of stand-alone systems but also interoperability testing of systems that are inter-networked. Note that the reports that are generated can be used as evidence for conformity assessment (CA), certification and even regulatory submission. As indicated in the figure, this approach applies directly to the need to test SDC networked systems (See Section 8.7 *Service Model: From abstract ICE to SOMDA to WS-** for more detail).

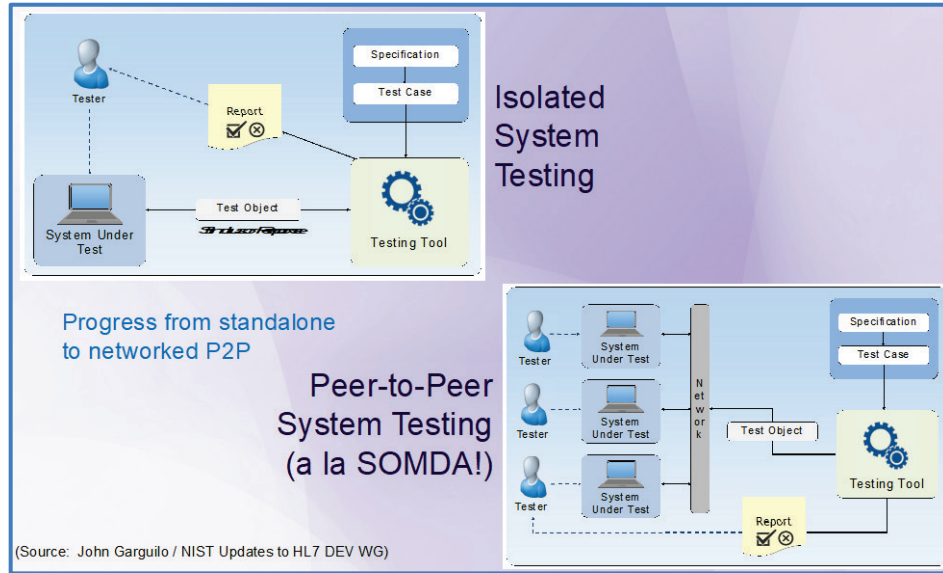

1065

Figure 10 NIST: Isolated vs. P2P / Networked System Testing

The distinction between conformance testing – to specific standards and specifications – and interoperability testing is illustrated in Figure 11.

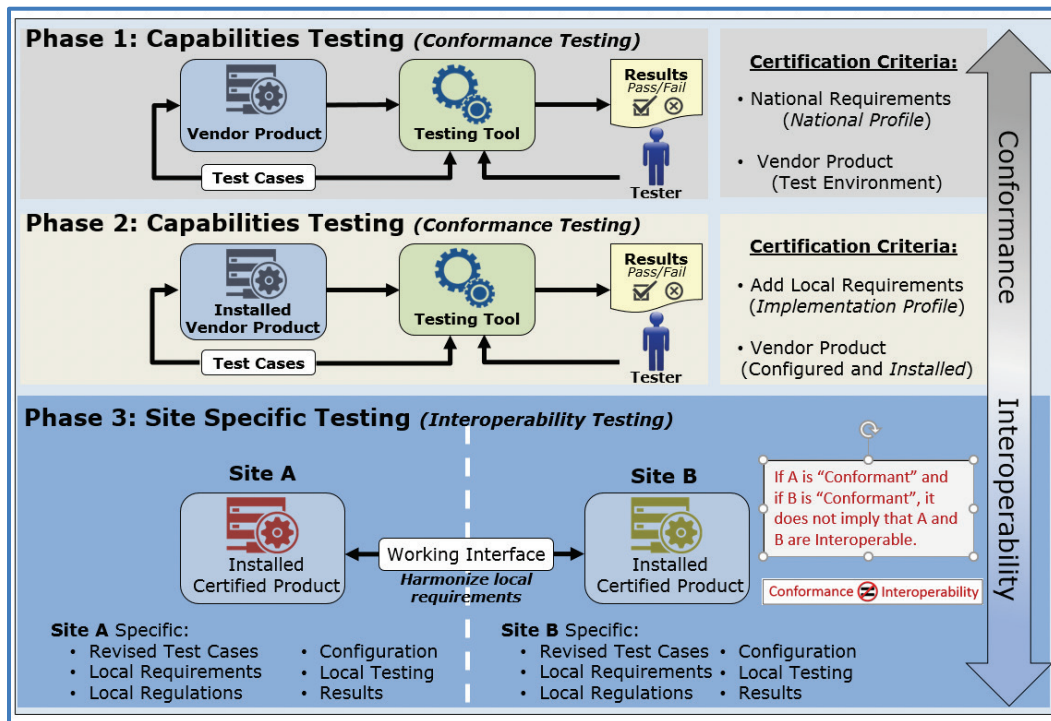

1070

Figure 11 NIST: Conformance to Interoperability Testing Phases

1075 IHE and NIST are committed to advancing rigorous conformance and interoperability testing, leading to product certification and solutions that deliver the intended benefits to patients and healthcare providers. This holds true for profiles in IT Infrastructure, Radiology, Cardiology, Pharmacy ... and Patient Care Devices.

7.4.2 Proposed NIST Framework Integrating SDPi Support

1080 NIST has been providing tooling support for both IHE PCD and IEEE 11073-based semantic standards for over 15 years. These tools form the core of testing at IHE Connectathons around the world and are in wide use throughout the industry. They not only focus on IHE PCD profiles' HL7 V2-based message testing, but also provide for *semantic interoperability* testing.

Access to the NIST tools is available via the portal at <https://hl7v2tools.nist.gov/portal/#/>.

1085 As the area of standards-based MDI expands, though, the NIST tooling framework – along with tools developed by other organizations – needs to be refactored to provide a clear picture of how each component might fit together in the future. *Figure 12 NIST Tooling Framework for Device Profiling & Validation (Proposed)* provides a proposal for a possible future framework that integrates support for SDC and SDPi interoperability.

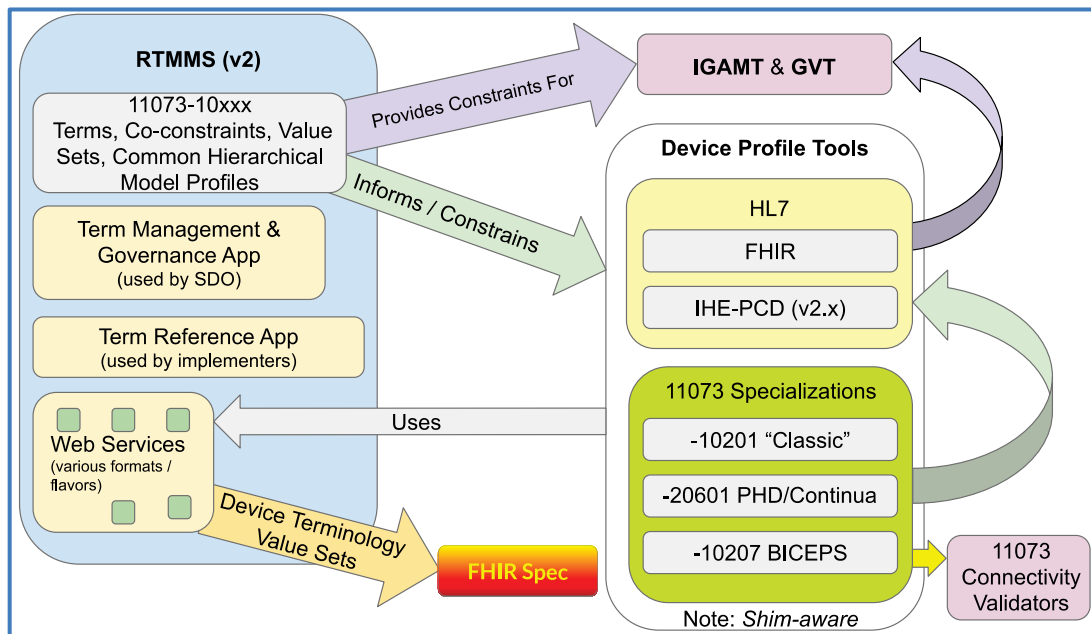

Figure 12 NIST Tooling Framework for Device Profiling & Validation (Proposed)

1090 As overviewed in *C.7 PCD Profile: Rosetta Terminology Mapping (RTM)*, the NIST RTM Management System (RTMMS) tool serves as the “gold standard” source for MDI semantic content, providing access both to the approved IEEE 11073-1010x terminology, but also defining co-constraints, value sets, and common medical device hierarchies (per IHE PCD TF-3). As illustrated in *Figure 12* above, a “v2” version of the tool is currently under development, which

1095 will provide even stronger support for both device semantic “profiling” – what a device actually supports – as well as validation tooling, with connection to NIST’s IGAMT & GVT tools (see *Figure 9*).

1100 RTMMSv2 provides not only the “gold standard” repository for IEEE 11073-based semantic standards and profiles, but also provides interfaces for term authoring (by authorized SMEs only) and research / browsing by users looking for terms applicable to their applications. The proposed “web services” interface allows access to RTMMSv2 functionality by external applications, such as independent device model profiling tools.

Note that the HL7 FHIR specification contains references for IEEE 11073 semantics that are managed within the RTMMS tool.

1105 “Device Profile Tools” provide a means for combining the core MDI semantics with other device modeling standards and specifications to create device-type specific profiles that can then be used for CAT and CA validation testing. Note that “shim-aware” points to the fact that though general standardized semantics are highly specified in the IEEE 11073 standards, some of the subsequent specifications relax constraints to facilitate implementation. Therefore, these
1110 profiling tools may have to include a “shim” function to apply a set of rules to transform from the representation in the RTMMSv2 database to what is profiled and tested.

It is recognized that some device specialization profiles may end up back in the foundational RTMMSv2 database to provide standardized “templates” for use by other device standardization and profiling activities.²³

1115 Finally, note the inclusion of the IEEE 11073-10207 BICEPS profiling tool that leverages semantic content from RTMMSv2 and generates those artifacts that are needed for SDC-specific validators, which is the topic of the next section.

7.4.3 Evolving SDC Community Tooling

1120 For the verification approach described in Section 7.4.2 above, multiple tools and test scripts have been developed over the last year from OR.NET, the MoVE project (MOVE) or manufacturers. Some of these tools or test scripts are intended to be realized for public use by test labs performing the SDC conformance assessment program or by manufacturers in order to get support during the development. This section describes some of the tools and approaches that have been completed or are in development.

1125 For the aspect of System Integration Test (see Section 7.4.1), two different kinds of verification measures have to be performed:

- Document inspection for requirements that have to be considered during the design or risk management process.

²³ It should be noted that governance for semantic content authoring is currently limited to the IEEE balloting process and is a subject for ongoing discussion in the MDI standards community.

- 1130 • Standardized tests against simulated communication partners with an independently developed SDC interface.

An example of the first type of requirement where document inspection needs to be performed is for R0047 [11073-20701:2018]:

An SDC PARTICIPANT SHALL mitigate RISKS related to delayed or lost MESSAGES if they result in an unacceptable RISK

- 1135 This requirement is verified by checking the Risk Management report of the SDC-enabled product. Other examples are requirements related to the Instructions for Use (IfU) that are part of the regulatory package for a medical device.

The second approach is used for technical requirements that can verified using software test tools.

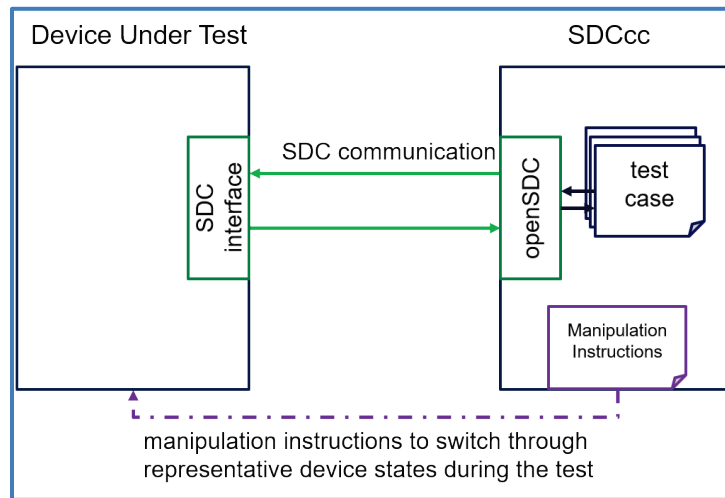

1140

Figure 13 Example of SDC Compliance Check Tool²⁴

- 1145 The first tool that is used for that purpose is the so-called “SDC conformance check” (SDCcc) which is a product agnostic test tool that uses an independent implementation of the IEEE 11073 SDC standards family (openSDC) and performs black box testing of the SDC-enabled device under testing (DuT). For SDCcc the tool first records all messages over a certain time period during which the DuT has to be manipulated to be in certain states (via a test script or “Manipulation Instructions”). In the second phase, the tool analyzes the collected messages with respect to the applicable requirements from the three IEEE 11073 SDC core specifications. Ultimately it automatically produces a test report with the verification results, where tests fail if a requirement is violated or no relevant message for the requirement can be found in the recorded messages.
- 1150

²⁴ Part of Dräger's Test2Interface tools.

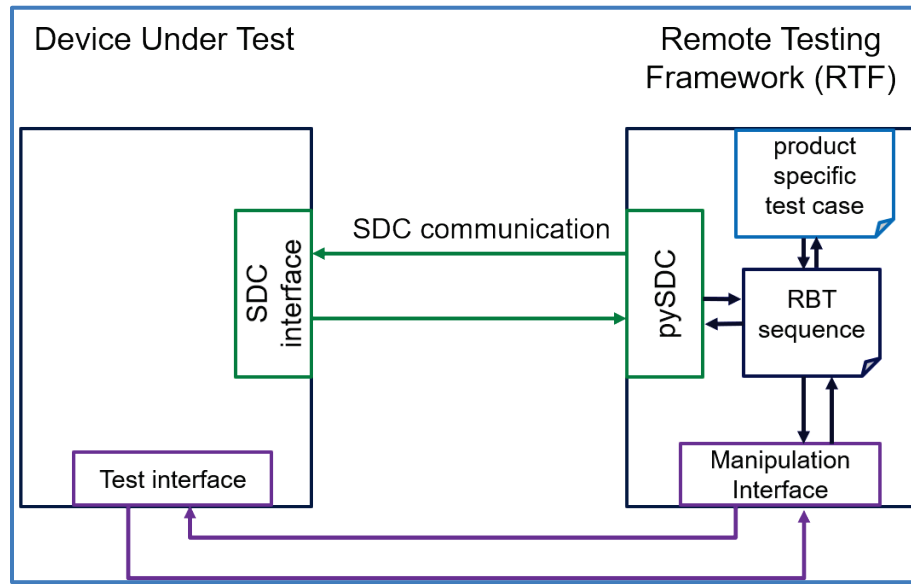

Figure 14 Example of SDC Role-based test suite ²⁴

1155 The second tool is the Role-Based Test (RBT) suite where the requirements of the System Function Contribution (e.g., the role to provide Metrics) are verified. For that purpose, RBT sequences are executed that are customized for the DuT based on a product specific reference file. The product specific reference file is essentially a snapshot of the device’s MDIB augmented with information for the RBT. The RBT suite includes also its own IEEE 11073 SDC implementation (pySDC) to simulate the 2nd SOMDS participant.

1160

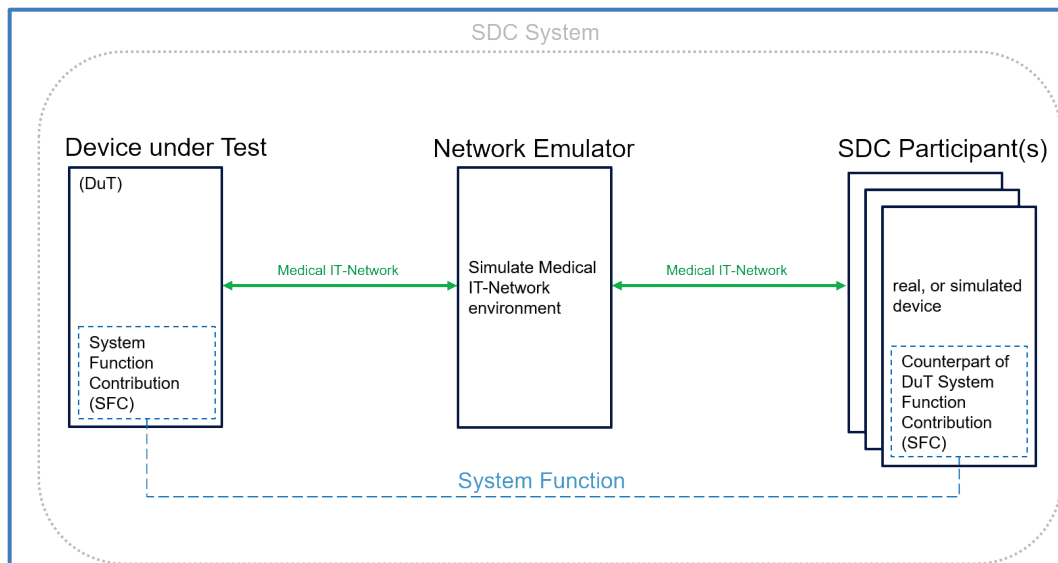

Figure 15 Reference System concept

As described in above, the Reference System test will be used to perform two types of testing:

- 1165 • Functional testing: The SDC-enabled product has to demonstrate its capability to perform its system functions in a representative system
- Non-Functional testing: The SDC-enabled product has to demonstrate its behavior in a representative system where the environment does not behave according to the required specification.

1170 The Reference System concept is depicted in *Figure 15*. The specific instance Reference System is setup in accordance with the IfU of the SDC-enabled product that is the Device under Test (DuT).

7.4.4 Integrating IHE & NIST Tooling Frameworks with SDC Community Tooling

1175 The challenge ahead is leveraging the strengths of the tooling presented in the sections above, that for IHE in general and that emerging from the SDC community (e.g., OR.net), to create a conformity test tool suite that can be used for connectathons, product certification and projectathons. This includes integration with the IHE Gazelle test event management tool, as well as the IHE conformity assessment program and tooling suite.

8.0 IEEE 11073 SDC Overview

- 1180 Though for many, IEEE 11073 Service-oriented Device Connectivity (SDC) may be new, it has actually evolved over nearly 15 years of effort, primarily in Germany, and undergone rigorous open development by a strong community subject matter experts, been the subject of numerous public demonstrations and testing events, prototyping and product development activities, and has seen its first SDC-enabled devices cleared for patient use in the operating room.
- 1185 All the information contained in this section was pulled from the various sources listed in *Appendix B – Bibliography*, where additional details can be found. The intent of this section is to provide a sufficient overview of SDC that will allow the reader to better understand the proposal for its integration into the IHE PCD Technical Framework.

8.1 Service-oriented Device-to-device Connectivity

- 1190 Most device connectivity architectures today are message-based. For example, the IHE PCD DEC Profile defines a message structure to convey information from a reporter actor to a consumer actor. Interoperability is achieved via a collection of specialized message specifications. Also, most device connectivity is realized between agent (device source) and manager (network controller) or “hub and spoke” architecture. Plug-and-play (see “*DPI*”
- 1195 *Device-to-Device Interoperability Overview* above) is typically achieved using a device-to-controller (agent to manager) architecture, that upon physical network connection defines an initial negotiation or “discovery” phase establishing the connectivity “ground rules”, and then information exchange (polled, periodic or episodic updates, or sometimes publication/subscription based), as well as functional service invocation (external control).
- 1200 SDC provides plug-and-play interoperability as well, using established web services specifications, but enables device-to-device (vs. device to manager) connectivity, where no specific “hub” function is required for purposeful²⁵ function. Figure 16 provides an overview of this architectural approach:

²⁵ Note: “purposeful” is further detailed below regarding the “key purposes” for which a service provider and consumer establish connection.

1205

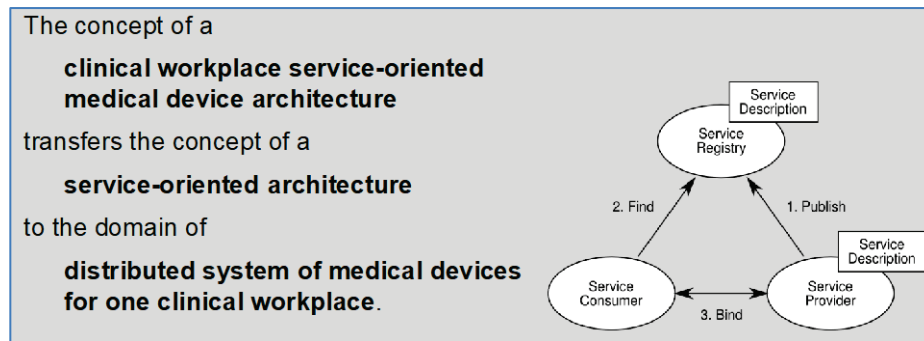

Figure 16 SOMDA Conceptual Model ²⁶

1210

In this general SOA model²⁷, a networked entity publishes a description of the services or capabilities it provides to a registry that then enables potential service consumers to be able to discover the availability of services, which systems provide those functions, and then to “bind” or access the services directly, with no other intermediary required. In the case of SDC, a device, system or application can publish a description of the “service” capabilities that it supports (e.g., information reporting, alerting and/or external control) that can be “discovered” by other networked entities and subscribed to or “consumed” as needed. As described in SOMDA Section 6:

1215

The architecture for a distributed system of PoC MEDICAL DEVICES in an INTEGRATED CLINICAL ENVIRONMENT (ICE) that is defined in this specification is following the concept of a CLINICAL WORKPLACE service-oriented medical device system (SOMDS).

1220

Note that SOMDA defines a distributed registry capability, where each participating entity provide this function. Also a single “smart” device can function as both a service provider and a service consumer.

Some additional definitions help explain terms used in *Figure 16*: ²⁸

1225

CLINICAL WORKPLACE: Set of medical devices that interacts with, monitors, or provides treatment to a *single patient*, or is setup to interact with, monitor, or provide treatment to a *single patient* by some other means.

NOTE—Besides direct announcement of being associated to the same patient a CLINICAL WORKPLACE can also be indicated by the same spatial location or treatment session.

²⁶ See IEEE 11073-20701:2018, section 6 *Service-oriented medical device exchange architecture* for more detail as well as definitions of key terms used in the diagram.

²⁷ See OASIS, Reference Model for Service Oriented Architecture 1.0, C. MacKenzie et al., October 2006. Available at <http://docs.oasis-open.org/soa-rm/v1.0/>.

²⁸ See IEEE 11073-20701:2018, Section 3 *Definitions*.

1230 **CLINICAL WORKPLACE SOMDS:** Subset of PARTICIPANTs of a service-oriented medical device system (SOMDS) that is assigned to one CLINICAL WORKPLACE.

CLINICAL WORKPLACE SOMDS PROXY SERVICE: Proxy service in a CLINICAL WORKPLACE that is an external interface to other systems.

1235 NOTE—Examples for external systems are network gateways, electronic health records (EHRs), central stations, wireless sensor networks, or other CLINICAL WORKPLACE service-oriented medical device system (SOMDSs).

INTEGRATED CLINICAL ENVIRONMENT (ICE): Environment that combines interoperable heterogeneous POINT-OF-CARE (PoC) MEDICAL DEVICES and other equipment integrated to create a medical device system for the care of a single high-acuity patient (ASTM F2761-09 [B1]).²⁹

1240 Therefore, the AAMI ICE conceptual model is realized in SDC as a single CLINICAL WORKPLACE as defined above, as illustrated in the following graphic:

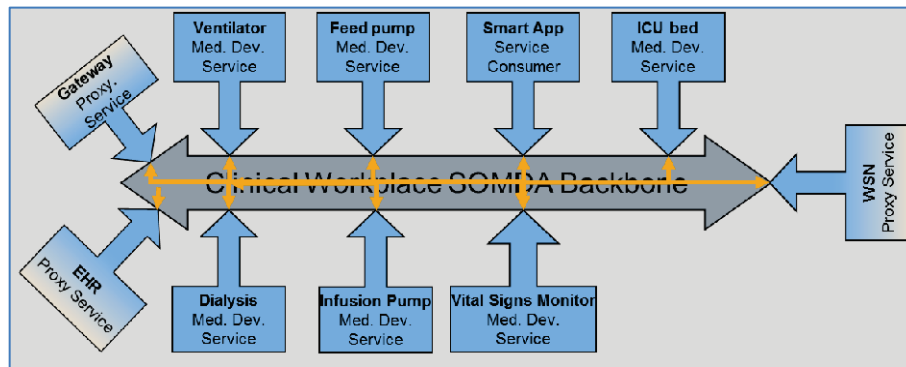

Figure 17 Example: SOMDA Clinical Workplace

1245 This illustrates the various types of participating systems that may be connected into a single ICU-based SOMDA network or “backbone”, including a variety of acute care medical devices, medical “apps”, and gateway “proxy” services including to EHRs and other systems. More examples of how these systems connect is provided in subsequent sections below and in the references provided in *Appendix B – Bibliography*.

1250 8.2 IEEE 11073 SDC Standards Family - Overview

The SDC family of standards builds on the well-established IEEE 11073 device interoperability standards, adding in a harmonized set of “core standards”, with additional standards supporting key purpose specification and device specializations currently under development. As indicated in Figure 18 IEEE 11073 SDC Family of Standards (“Cathedral Window”), the “core” standards have been published, both by IEEE as well as by ISO & CEN; whereas, the green Key Purposes standards are in process and should be approved for publication in 2020, with the Device

²⁹ Note that this standard has now been transferred to AAMI as AAMI 2761.

Specialization standards following soon thereafter. Note that all the green and light yellow standards are approved IEEE projects (or “PARs”).

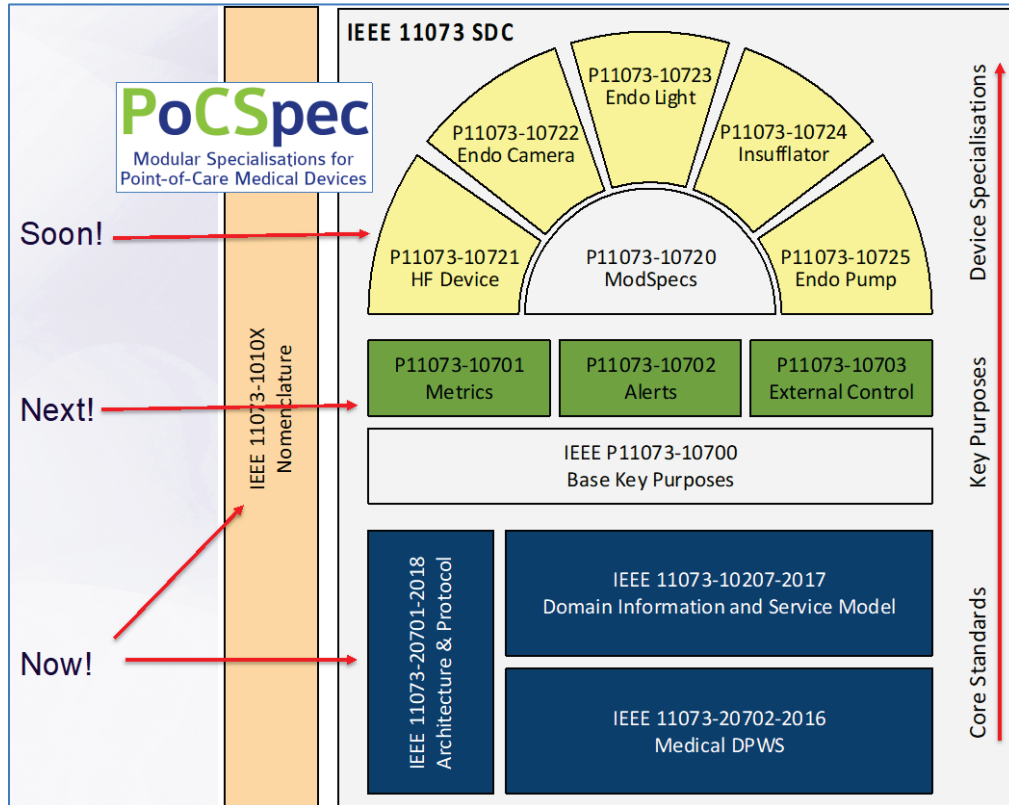

Figure 18 IEEE 11073 SDC Family of Standards (“Cathedral Window”)

In the above graphic, the IEEE 11073 SDC-specific standards are identified on the right, with the established core IEEE 11073 semantic content by the vertical bar on the left. Additional background information on these IEEE standards:

1265

11073-1010x Nomenclature or terminology with 1,000’s of terms specialized for medical device informatics, providing a much higher level of granularity than similar concepts in other systems such as LOINC. The foundational 11073-10101 standard provides the core set of terms; whereas, other “x” standards focus on specific areas such as Annotated ECG content representation.

1270

11073-10201 Medical device domain information model (DIM), which together with the nomenclature standards above forms the core 11073 semantic content standards that are leveraged by most interoperable device solutions.³⁰

³⁰ Note that a more detailed treatment of the broad use of IEEE 11073 semantic content standards can be found in *Appendix B – Bibliography*.

1275 **11073-10207** SDC “BICEPS” standard that leverages the 11073-10201 DIM and specializes it for use in SOMDA environments; this forms the abstract semantic and service model for SDC. See Figure 19 below, as well as Sections 8.6 and 8.7.

1280 **11073-1070x** These four standards (in development) address the intended use or “key purposes” for providing a set of service capabilities; this is especially important to understanding the potential risks³¹ associated with a given service as well as the possible regulatory needs around ensuring safety, security and effectiveness. See Section 9.5 *Regulatory Requirements & Approach*.

11073-1072x to -10799

1285 Device specialization or “module specification” standards build upon the Core SDC and 11073 standards, leveraging the key purposes standards, to define device or device component (module) specifications; See also Section 9.1 *General Connectivity to Device Specializations*.

11073-20701 SDC “SOMDA” (“glue”) standard between the abstract BICEPS specification and the implementation-technology specific MDPWS standard, defining the overall SDC network architecture and interoperability protocol specification. See Section 8.7.2 *Service Oriented Medical Device Architecture (SOMDA)*.

1290 **11073-20702** SDC “MDPWS” standard connects the architecture and services defined in SOMDA with standardized web services (WS-*) technologies, leveraging the Oasis standard: Device Profile for Web Services (DPWS).³² See Section 8.7.3 *Medical Device Profile for Web Services (MDPWS)*.

1295 Additionally, Figure 18 IEEE 11073 SDC Family of Standards (“Cathedral Window”) calls out the “PoCSpec” project³³, which is an EU funded effort led by the non-profit OR.net group to develop the active (11) IEEE SDC standards as well as test tools for SDC-enabled systems. Also, though the foundational IEEE 11073-1010x Nomenclature is called out on the graphic and when coupled with the IEEE 11073-10201 forms the core medical device semantic content standards, additional work has been done within IHE in conjunction with NIST and others to define a robust “gold standard” specification and support tools for device informatics. See Section 7.4.2 *Proposed NIST Framework Integrating SDPi Support* for more detail on “RTMMSv2” and the proposed tooling framework.

1300 Figure 19 BICEPS Standard Components provides additional perspective on SDC interoperability:

³¹ IEC 80001-1 and ISO 14971 standards, among others, provide additional background and perspective. See also the FDASIA final report referenced in *Appendix B – Bibliography*.

³² Note that the layering of SDC specifications between the three “core” standards, allows alternative implementation technologies to be selected in place of WS-* and still maintain the functionality and architecture defined in BICEPS and SOMDA. See section 9.9 *Considering Additional Integration Architectures – RESTful, DDS, ...* for more background.

³³ See <http://ornet.med-design.net/en/services-2-3/services-2-5/services-2-3-4/>.

1305

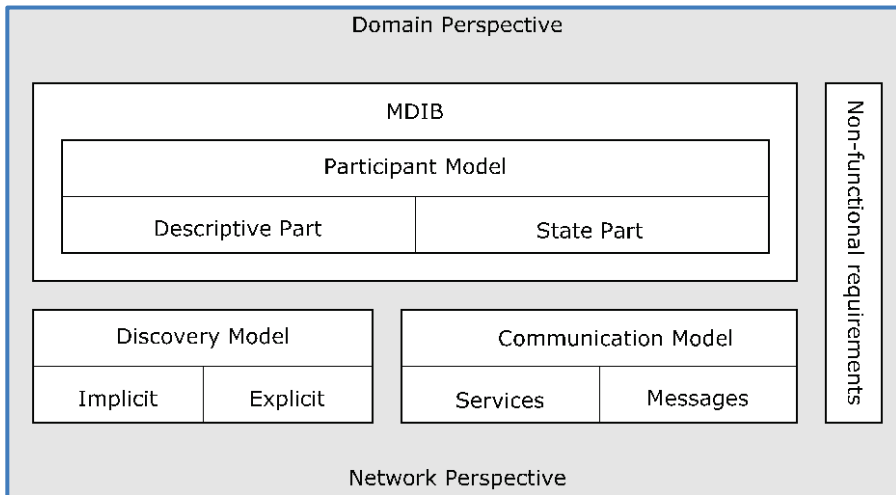

Figure 19 BICEPS Standard Components ³⁴

SDC bridges between the medical device informatics “domain” perspective, which is concerned with specification of a participant systems “MDIB” (Medical Data Information Base) that includes a “containment tree” as defined in SOMDA:

CONTAINMENT TREE: Device configuration and capability description of a medical device system that represents a POINT-OF-CARE (PoC) MEDICAL DEVICE.

NOTE—It is modeled as a tree with a depth of four.

Which is based on the BICEPS (and IEEE 11073-10201) definition of MDIB:

MEDICAL DATA INFORMATION BASE (MDIB): Structured collection of any data objects that are provided by a particular POC MEDICAL DEVICE. MDIB includes descriptive and state information.

Additionally, a “network” perspective that focuses on how participating systems are discovered over a SOMDA network, and the communications model for establishing connectivity and interoperability between two or more entities. Note that these standard BICEPS components are abstract and provide requirements that must be met by the SOMDA and MDPWS standards. Also, as illustrated in Figure 29 SDC Basic Discovery & Exchange below, “Implicit” discovery is provided when a participating system announces or publishes its presence to the network; whereas, “Explicit” discovery is when a consuming participant publishes a “service request” to the network, looking for any systems that may provide the needed capabilities.

³⁴ Source: IEEE 11073-10207:2017 Figure 2, section 2 Introduction to BICEPS.

8.3 Functional vs. Non-functional Requirements

1330 *Figure 19 BICEPS Standard Components* above also includes a BICEPS reference to “Non-functional requirements.” This refers to those networked device capabilities that are important for other SDC systems to know, such as security or patient safety or regulatory requirements, but are beyond the core functionality for which the device was placed into service, namely functional requirements such as measuring blood pressure or delivering a dose of medication.

This is of particular importance in that standards such as IEC 80001-1:2010 on risk management include in their 3 key properties “effectiveness”, which addresses a device’s ability or potential risk that it cannot provide both functional and non-functional capabilities and services. 1335 Understanding how a device communicates these requirements along with the key purposes discussed above (subject of the 11073-1070x standards) to other networked environment participants is key to achieving real-time safety, effectiveness and security – especially in high-acuity use contexts.

See Section 9.5 *Regulatory Requirements & Approach* for additional discussion.

1340 8.4 Gateways Connecting Point of Care & Hospital Enterprise

As illustrated in Figure 17 Example: SOMDA Clinical Workplace and Figure 20 SDC Point-of-Care Gateway to Hospital Enterprise Systems below, SDC network participants do not necessarily operate in isolation from the “outside world” and require some means of maintaining bidirectional interaction with these external systems. This function is typically provided by a 1345 network “gateway” or SOMDS proxy, defined in SOMDA as follows:

CLINICAL WORKPLACE SOMDS PROXY SERVICE: Proxy service in a CLINICAL WORKPLACE that is an external interface to other systems.

1350 NOTE—Examples for external systems are **network gateways**, electronic health records (EHRs), central stations, wireless sensor networks, or other CLINICAL WORKPLACE service-oriented medical device system (SOMDSs).

A SOMDS proxy can be realized as either a “service consumer” providing SDC-sourced information and services to a gateway or a “service provider”, enabling networked SOMDS devices to interface with other external systems. Figure 20 SDC Point-of-Care Gateway to Hospital Enterprise Systems provides examples of when an SDC or SOMDS network instance 1355 might need to interact, bidirectionally, with other Hospital IT or enterprise systems, and in so doing will leverage different interoperability paradigms and protocols such as HL7 V2 messaging, FHIR (RESTful, messages, documents or SOA paradigms), or DICOM imaging.

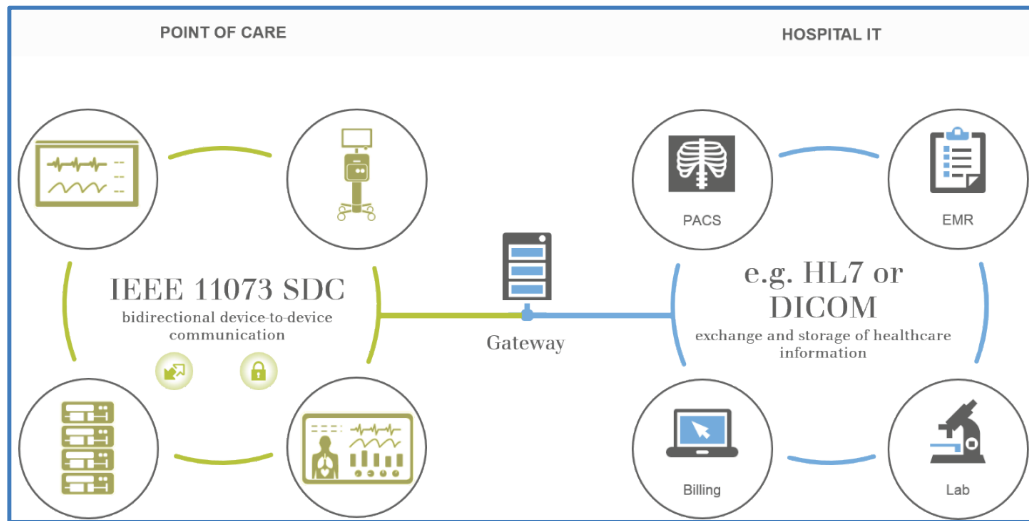

Figure 20 SDC Point-of-Care Gateway to Hospital Enterprise Systems

1360

In this case, a proxy **Service Provider** “Gateway” might provide patient / clinical context to entities in a SOMDS, and a **Service Consumer** could forward measurements or alarms from the CLINICAL WORKPLACE SOMDS to enterprise systems like an EMR or Alarm Manager.

1365

IHE technical framework specifications or “profiles” provide solutions for the connectivity on the right side of this diagram, including solutions for sharing administrative patient information, images and documents. The IHE PCD technical framework is also enterprise focused, providing the primary means for sending device-sourced content to other enterprise systems, such as an EMR or electronic medication administration record system.

1370

Use case stories describing the bidirectional communication needed by SDC networked devices are detailed in *10.1.1 Use Cases & Requirements* below, with specific examples of gateways called out in the SDPi Profile proposal sections in *10.2 Volume 1: Interoperability Profiles*.

1375

In IHE technical frameworks, inter-protocol or inter-profile gateways are typically represented by “grouped” actors, where the actor from one profile, such as an IHE DEC DeviceObservationReportor (DOR) Actor is combined with an SDPi-R ConsumerProxy Actor, with the interface “line” between the two representing the logic that is required to effect the desired level of interoperability. *Figure 77 IHE MHD "XDS on FHIR" Model* provides an example where an XDS.b Source actor is combined with an MHD DocumentRecipient Actor, which uses HL7 FHIR, and an XDS.b DocumentSource that uses ITI WS-* SOAP messaging profile.

1380

See *Appendix B – Bibliography* for additional reference information.

8.5 SDC from an ASTM/AAMI ICE Conceptual Model Perspective

1385 The Integrated Clinical Environment (ICE) is a medical device system that integrates interoperable heterogeneous MEDICAL DEVICES and other equipment for the care of a single high-acuity patient (see ASTM F2761-09) at the Point of Care (PoC).

The main elements of the ICE conceptual model include:

- SUPERVISOR
- MANAGER
- NETWORK CONTROLLER
- 1390 • EQUIPMENT INTERFACE
- DEVICE MODEL
- INTERFACE DESCRIPTION LANGUAGE

The SDPi profiles and especially the IEEE 11073 SDC standards can be utilized to implement an architecture that is conformant to the ICE conceptual model.³⁵

1395 *Figure 21* maps the capabilities of the ICE-compatible equipment into SDPi using the BICEPS participant model that is based on BICEPS services. BICEPS services represent the ICE EQUIPMENT INTERFACE, and in order to be fully compliant a SERVICE PROVIDER has to be an SDC SERVICE PROVIDER.

³⁵ Note that the conceptual model graphic (left part) in *Figure 21* and *Figure 22* are sourced from *AAMI 2700-1:2019, Medical Devices and Medical Systems—Essential safety requirements for equipment comprising the patient-centric integrated clinical environment (ICE) — Part 1: General requirements and conceptual model*.

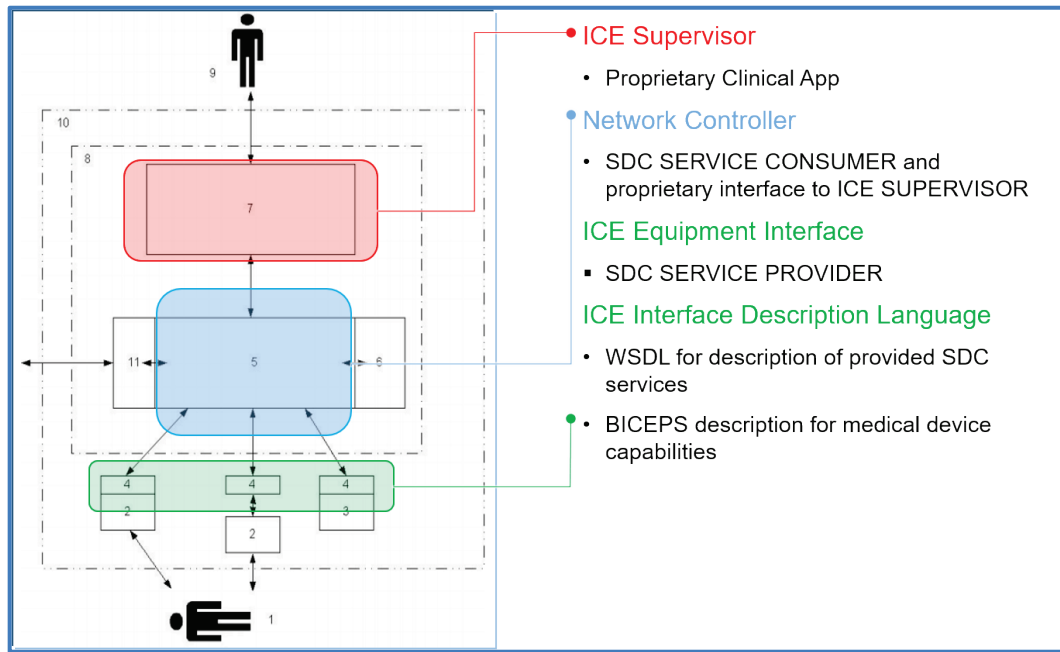

1400

Figure 21 Mapping of IEEE 11073 SDC to ICE Conceptual Model

1405

1410

The simplest form of implementation is depicted in *Figure 21*, where the PoC Medical Devices implement an SDC SERVICE PROVIDER. The PoC Medical Devices are considered to be ICE-COMPATIBLE EQUIPMENT as they offer BICEPS services as an SDC SERVICE PROVIDER, which can be considered an ICE EQUIPMENT INTERFACE. The SDC SERVICE PROVIDER can be either directly connected to the hardware that the ICE NETWORK CONTROLLER is operated on or to a network switch that is potentially monitored. The ICE NETWORK CONTROLLER implements an SDC SERVICE CONSUMER and the data logger can be implemented as part of the SDC SERVICE CONSUMER that in order to be conformant must log relevant data as specified in the ICE standard. The communication between the ICE NETWORK CONTROLLER (SDC SERVICE CONSUMER) and the ICE SUPERVISOR can then be a non-standardized protocol.

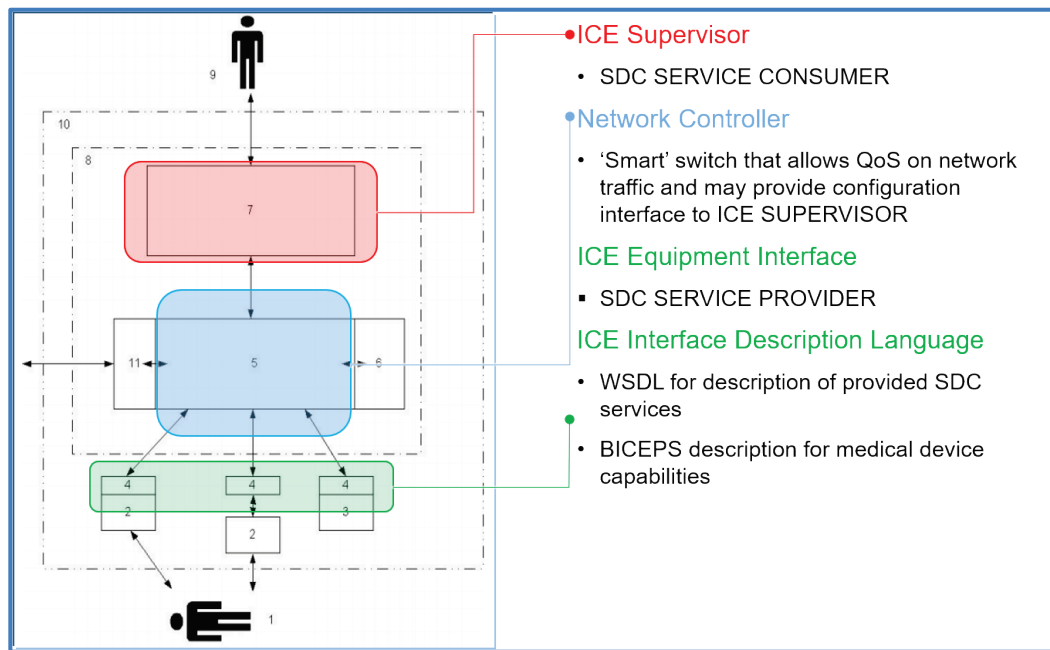

Figure 22 Alternative Mapping of IEEE 11073 SDC to ICE Conceptual Model

1415 In an alternative implementation (see *Figure 22*), the ICE SUPERVISOR implements the SDC SERVICE CONSUMER and the ICE NETWORK LOGGER is basically a smart switch that provides Quality of Service as needed by the SDC SERVICE PROVIDER. In some instances, the ICE NETWORK CONTROLLER is configured by the ICE SUPERVISOR depending on the application specific needs and the information provided by the SDC SERVICE PROVIDER.

1420 The data logger in this case would be implemented as a separate SDC SERVICE CONSUMER to capture the data that is provided by the SDC SERVICE PROVIDER including state of external control commands and settings.

1425 It should be noted that SDPi does not support the state of “MODEL COMPLIANT” as defined in the ICE conceptual model³⁶, but only the FULLY COMPLIANT state. To include legacy products that cannot implement an SDC SERVICE PROVIDER on their own, so-called SDC protocol converters have to be used that are conformant SDC SERVICE PROVIDER and map the communication to the protocol elements of the legacy product.

³⁶ Essentially, MODEL COMPLIANT indicates that a device does not export its capabilities via the interface but relies on the receiving systems to know the information and functions supported by the interface a priori. SDC does not support this, nor any other IEEE 11073 enabled interfaces. Instead, an SDC SERVICE PROVIDER must (shall) communicate comprehensively its capabilities, both via the WS-* interface and for conformance purposes, in a WSDL specification file available “externally” for use in conformity assessment testing.

8.6 Semantic Model: From Nomenclature to Information Models

- 1430 Semantic interoperability³⁷ is of primary importance for achieving true interoperability – where all entities exchanging information interpret the content in exactly the same way. This begins with a standardized granular terminology or nomenclature, that provides naming for every bit of information³⁸ that is exchanged (including the names of data element fields, as well as the content that they contain), and extends to the standardized set of information objects and their
- 1435 inter-relationships that are defined to communicate everything related to a device or device service. The IEEE 11073 standards include a core nomenclature specification, IEEE 11073-10101, as well as an information model, IEEE 11073-10201, that have been widely used in medical device informatics, including IHE PCD HL7 v2 profiles, Devices on FHIR, IEEE 11073 personal health device standards, and the DDS-based MDPnP³⁹ / OpenICE specifications.
- 1440 SDC and BICEPS leverages these core semantic interoperability standards to ensure consistency and harmonization with this strong foundation. *Figure 23 SDC Medical Device Information Model* details the concepts that have been utilized from the foundational IEEE 11073-10201 domain information model standard.

³⁷ See section 9.8 *Interoperability Maturity Models for SDC Roadmapping* for additional perspective.

³⁸ One may consider the “DIKW” Pyramid and the role medical device semantic interoperability plays. See https://en.wikipedia.org/wiki/DIKW_pyramid.

³⁹ See MDPnP.org for more information.

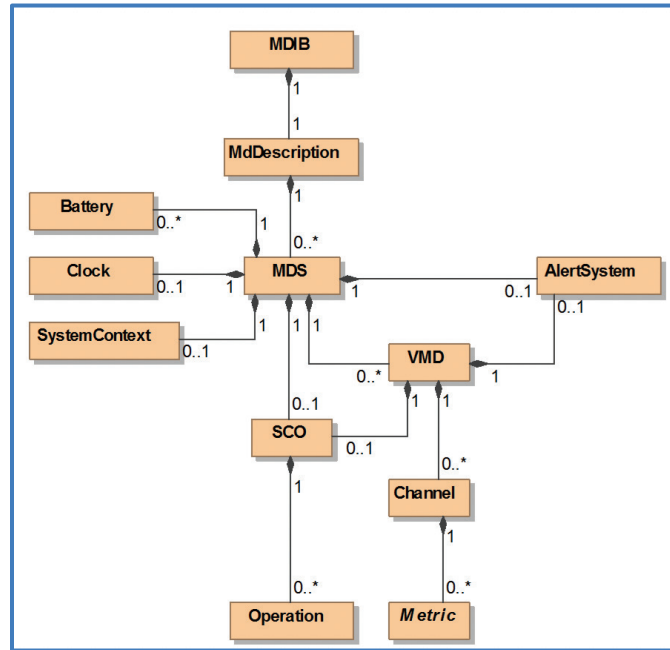

Figure 23 SDC Medical Device Information Model⁴⁰

1445

Of particular note is the containment of: MDS to VMD to Channel to Metric. This is consistently utilized across standardized medical device informatics technologies. This model supports the core connectivity capabilities of discovery & association (DnA), reporting, alerting and external control. Specific information model objects of note:

1450

- MDIB** Object that comprises the capability description of the represented MDSs in pm:MdDescription (descriptive part) as well as the current state in pm:MdState (state part).⁴¹
- MdDescription** MdDescription is the root container to represent the descriptive part of the MDIB. The descriptive part describes the capabilities provided by a POC MEDICAL DEVICE, e.g., which measurements, alerts and settings it provides.
- SystemContext** The context of an MDS that lists the possible relationship of a POC MEDICAL DEVICE into its usage environment by means of context descriptors.

⁴⁰ Source: IEEE 11073-10207. See *Appendix B – Bibliography*.

⁴¹ In SDC, “pm:” refers to an SDC participant model definition. See IEEE 11073-10207, 3.2.2 *XML Schema namespaces*.

MDS	MdsDescriptor represents an MDS that in turn represents a POC MEDICAL DEVICE such as an anesthesia workstation.
VMD	Representation for a medical-related subsystem (e.g., hardware or even pure software) of a POC MEDICAL DEVICE..
Channel	Representation for a logical or physical grouping of METRICs that allows hierarchical information organization.
Metric	Representation of a component of a POC MEDICAL DEVICE that is able to generate or store direct and derived, quantitative and qualitative biosignal measurements, settings, and status values.
SCO	A POC MEDICAL DEVICE allows SERVICE CONSUMERs to request remote control commands by means of the service control object (SCO).
AlertSystem	Representation of an ALARM SYSTEM of a PoC Medical Device that can detect ALARM CONDITIONs and can generate ALARM SIGNALs.

1455 When comparing with the “classic” IEEE 11073-10201 information model, the careful observer will note the absence of some packages of objects. In the case of Extended Service or Communication packages, this is due to the fact that BICEPS uses a different service-oriented communication model, replacing the functionality provided in these “classic” packages. In the case of the Archival and Patient packages, though, these capabilities have been moved into the SystemContextDescriptor, specifically the Archive service (see below) and the PatientContext in the MdsDescriptor(i.e., pm: MdsDescriptor/ pm:SystemContext:/ pm:PatientContextDescriptor)^{Error! Bookmark not defined.}. Therefore, the functionality is preserved, 1460 but the information model organization is slightly modified.

1465 Also, there is a close relationship between the information model above and the IEEE 11073-10101 nomenclature, which includes terms for device types such as Anesthesia System or Ventilator, as well as identifiers for specific object types such as Channel or SCO. The same tight coupling between 11073-10101 and the “classic” -10201, is maintained in the BICEPTS 11073-10207.

1470 Finally, it should be noted that as explained in Section 7.4.2 *Proposed NIST Framework Integrating SDPi Support* above, the RTMMSv2 tool coupled with the Device Profile Tools can produce specifications that are conformant to the base standards, including mandatory, optional, conditional and extended capabilities, but that are tailored for a specific device type or even manufacturer/make/model. In order to maximize semantic interoperability, standardized device “module” specifications³³, as illustrated toward the top of *Figure 18* above, define device modality components that can be reused across many different real-world device instantiations. Regarding the components in *Figure 23*, Metric, Channel and VMD objects tend to be highly reusable, whereas VMD and especially MDS objects reflect a device’s internal modular

1475 architecture, including provision for additional device-wide capabilities such as battery or patient
 1480 context.

8.7 Service Model: From abstract ICE to SOMDA to WS-*

The three core SDC standards below provide a layered “service model” specification from the
 1480 abstract 11073-10207 BICEPS, which defines implementation-technology agnostic capabilities,
 to the 11073-20701 SOMDA architecture model that provides the “glue” between the abstract
 BICEPS specification and any implementation technologies, and finally the 11073-20702
 MDPWS, which identifies the WS-* implementation specific details that are needed to achieve
 interoperability between all participating SDC systems. The following graphic illustrates the
 relationship and capabilities between the three core SDC standards:

1485

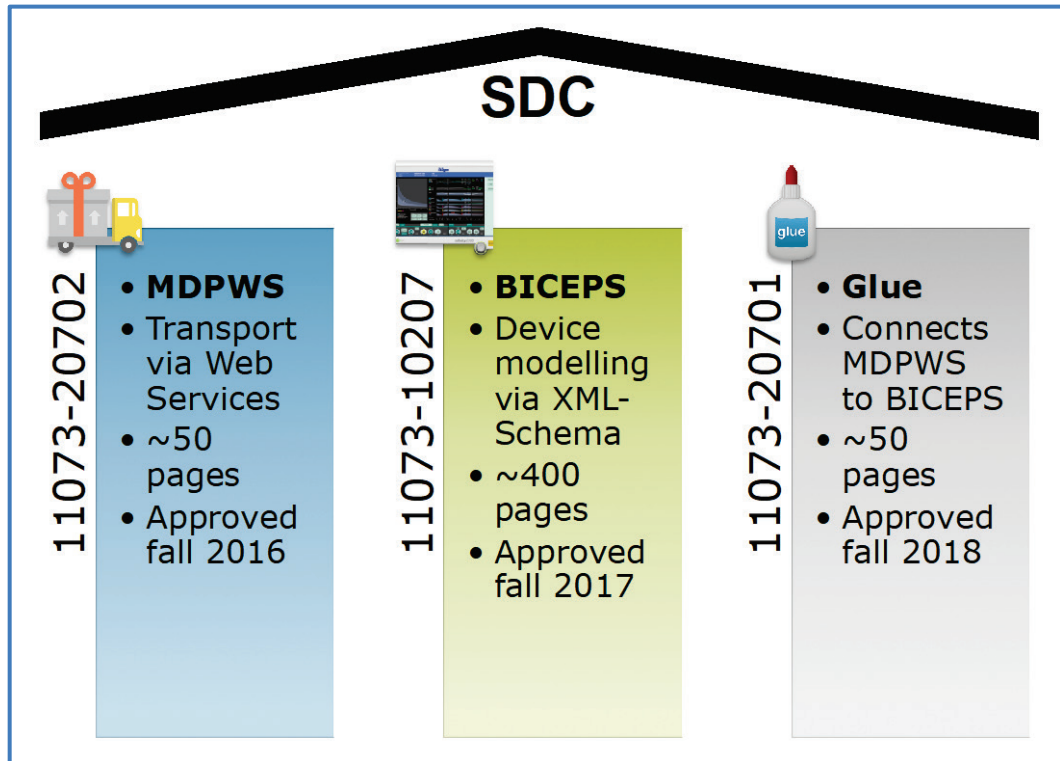

Figure 24 SDC 11073 Core Standards - Functional Scope

Note that the SOMDA or “glue” standard provides the architectural mapping between the WS-*
 1490 Profile “truck transport” standard and the BICEPS “information and services” standard. The
 following sections provide additional detail. Note that this detail lays the foundation for the
 capabilities that will need to be provided in the proposed SDPi profiles later in the document.

8.7.1 Basic ICE Protocol Specification (BICEPS) Services

1495 Whereas 8.6 Semantic Model: From Nomenclature to Information Models above focused on the SDC information model aspects of the BICEPS standard, Figure 25 below summarizes the BICEPS abstract service model that is used to achieve SDC interoperability:

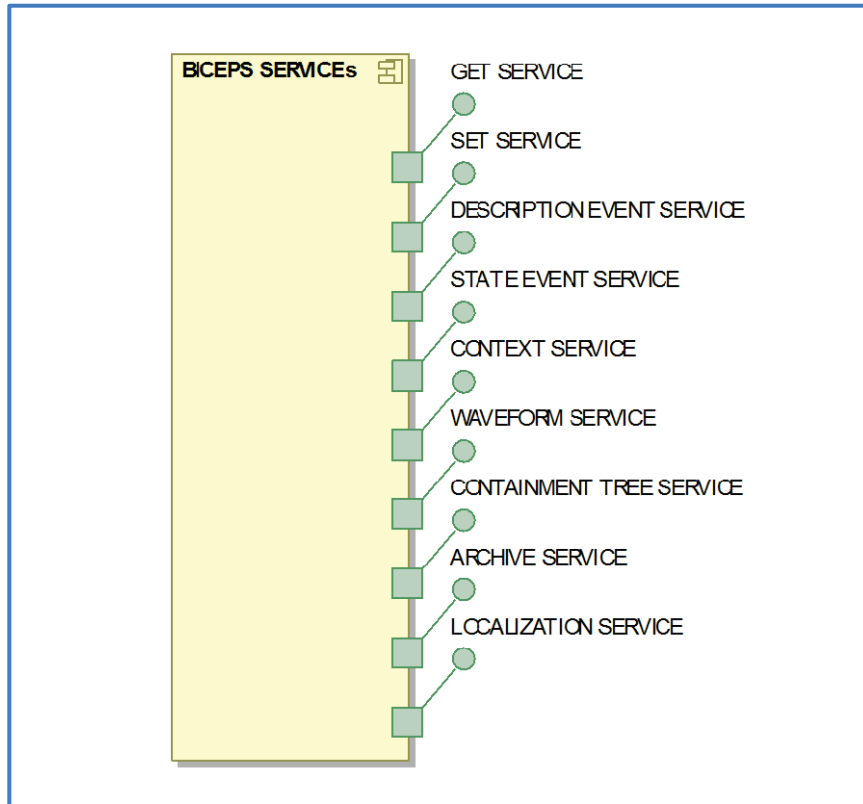

Figure 25 SDC BICEPS Service Model

BICEPS communication services include:

- GET** The GET SERVICE defines an interface that allows a SERVICE CONSUMER to retrieve the description and state of an MDIB by using pull SERVICE OPERATIONS.
- SET** The SET SERVICE defines an interface that allows a SERVICE CONSUMER to change the state part of the MDIB, and is therefore a SERVICE to enable remote control of POC MEDICAL DEVICES.
- Description Event** The DESCRIPTION EVENT SERVICE defines an interface that allows a SERVICE CONSUMER to listen for any pm:AbstractDescriptor element changes in an MDIB.

State Event	The STATE EVENT SERVICE defines an interface that allows a SERVICE CONSUMER to listen for any pm:AbstractState element changes in an MDIB.
Context	The CONTEXT SERVICE defines an interface that allows a SERVICE CONSUMER to request pm:AbstractContextState ELEMENTs by pull or push SERVICE OPERATIONS.
Waveform	The WAVEFORM SERVICE defines an interface that allows a SERVICE CONSUMER to listen for any real time sample array metrics in an MDIB.
Containment Tree	The CONTAINMENT TREE SERVICE defines an interface that allows a SERVICE CONSUMER to navigate through the CONTAINMENT TREE of an MDIB and request specific pm:AbstractDescriptor ELEMENTs.
Archive	The ARCHIVE SERVICE defines an interface that allows a SERVICE CONSUMER to retrieve historical data of an MDIB.
Localization	The LOCALIZATION SERVICE defines an interface that allows a SERVICE CONSUMER to retrieve human-readable texts in different languages from a translation table.

1500 As explained, the BICEPS standard adapts the service model specified in the “classic” IEEE 11073 standards. *Figure 26* shows a mapping between the “classic” 11073 “Common Medical Device Information Service Element” (CMDISE) service model and the BICEPS Services model.⁴²

⁴² Note that an additional mapping “arrow” should link from the CMDISE “Event Report” to the BICEPS “Waveform” service.

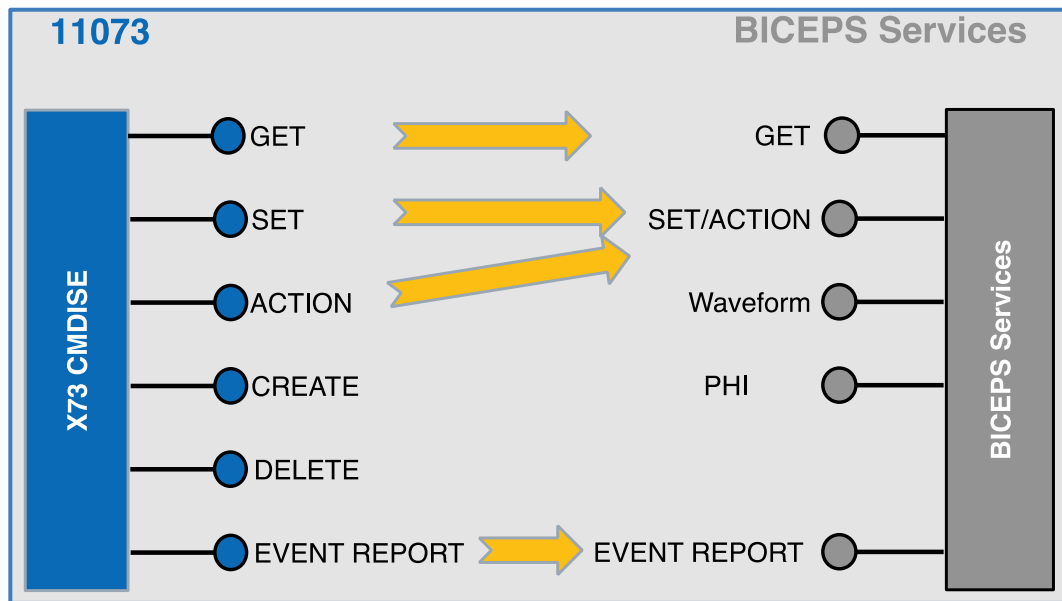

1505

Figure 26 Comparison of 11073 "Classic" to BICEPS Service Models

When comparing SDC with the IEEE 11073 “classic” service model, it could be said that the IEEE Application Profile standards 11073-20101⁴³ and -2020x CMDISE standards are replaced by the 11073-2070x standards when SDC is used as the architecture and communications technology.

1510

8.7.2 Service Oriented Medical Device Architecture (SOMDA)

As stated above, the IEEE 11073-20701 SOMDA standard provides the architectural “glue” between the abstract information model and services definition in BICEPS and the implementation detail WS-* capabilities in IEEE 11073-20701 MDPWS (see below). As such it provides bindings for:

1515

- ✓ BICEPS use of 11073-1010x nomenclature / terminology, including the use of both context-sensitive (16-bit) and context-free (32-bit) codes
 - Note: provision is made for the use of other nomenclatures if there is no 11073 definition or if the application context warrants alternative coding systems, such as LOINC or SNOMED-CT.
- ✓ BICEPS participant model (“pm:”) bindings, including for remote control, dynamically configurable devices (see BICEPS for a comprehensive list of pm: definitions)

1520

⁴³ Note that the IEEE personal health device standard 11073-20601 Optimized Exchange Protocol leverages the on-the-wire encoding rules in 11073-20101; however, it is duplicated so as to ensure that -20601 is self-contained and can stand-alone.

- 1525 ✓ BICEPS message and service model bindings to the MDPWS transport, including discovery, subscription (with filtering mechanisms), large payloads and localization services (e.g., uploading natural language-specific text strings).
- ✓ BICEPS non-functional requirements including cybersecurity (including certificate considerations), patient safety / trust establishment, clinical effectiveness / clock and timestamp management, and QoS transmission attributes.
- ✓ FDA and EU UDI (Unique Device Identifier) bindings are also specified.

1530 All of the above, along with identified conformance options (mandatory & optional), need to be addressed in any SDPi Profile specifications, either in the base profiles or in profile options.

1535 Finally, though SOMDA is specifically intended to provide the glue between BICEPS and MDPWS, it was architected in such a way as to allow binding to other transport technologies, including DDS. See Section 9.9 *Considering Additional Integration Architectures – RESTful, DDS, ...* for more information on support for this alternative transport.

8.7.3 Medical Device Profile for Web Services (MDPWS)

1540 The Medical Device Profile for Web Services (MDPWS) is based on the Device Profile for Web Services (DPWS) – in version 1.1. DPWS is an OASIS standard since June 2009 – and defines a minimal set of Web Services specifications for resource-constrained devices that possess an IP-based network interface.

The origins of DPWS are in the consumer electronics domain where it is used in network printers or image scanners to allow plug & play. It had been pushed forward by Microsoft for printer integration and consequently all Microsoft Windows OS starting from Vista already include a native DPWS stack.

1545 The main concept behind DPWS is shown in *Figure 27 WS-* Reference Profile Stack*.

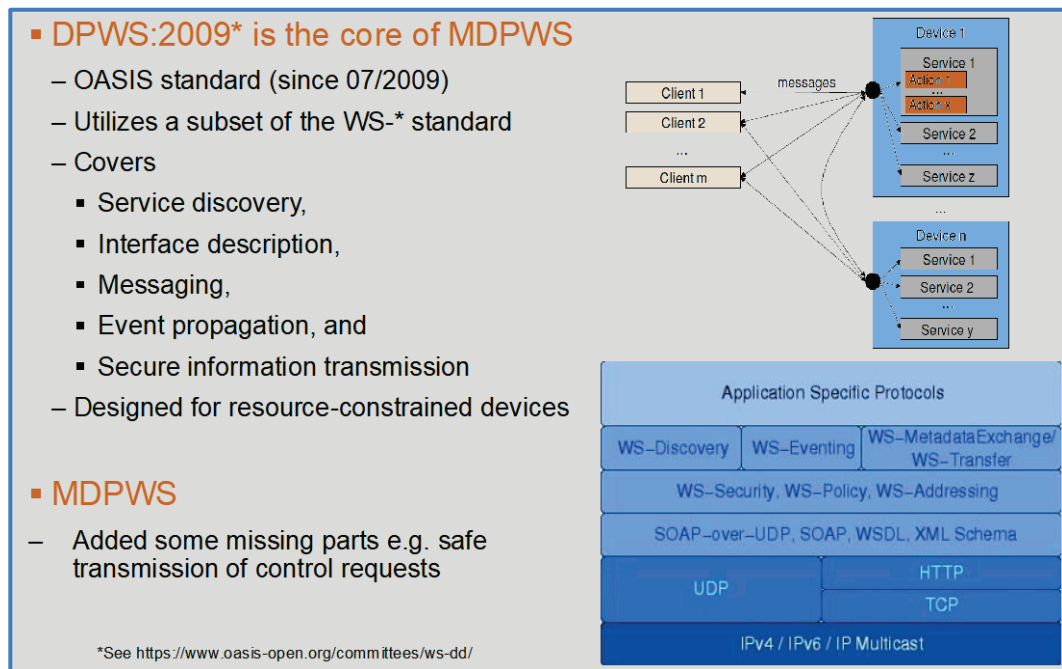

Figure 27 WS-* Reference Profile Stack

1550 In a DPWS setup there exist at least one client – an endpoint in the network and service consumer in a SOA – which sends respectively, receives messages. The partner in the messages exchange is a service (service provider in SOA). There exist two types of services: device service and hosted service.

1555 A device is a service, also called hosting service that acts primarily as a metadata resource for device-wide data. A device can contain other services, so called hosted services, which are bound to their hosting service regarding life-time but can be addressed separately.

DPWS provides the following functionalities:

- ✓ Discovering DPWS-capable devices on the network and their offered hosted services
- ✓ Describing services by providing a WSDL file
- ✓ Interacting with a service based on its service description
- 1560 ✓ Subscribing to and receiving notifications from a Web Service

In order to provide these functionalities, DPWS leverages and profiles a set of other specifications (cf. Figure 27), for example, starting with WS-Eventing all the way down to IPv4 standard.

1565 Another view of the extended capabilities provided by the MDPWS standard is provided in Figure 28 MDPWS Extended Capabilities.

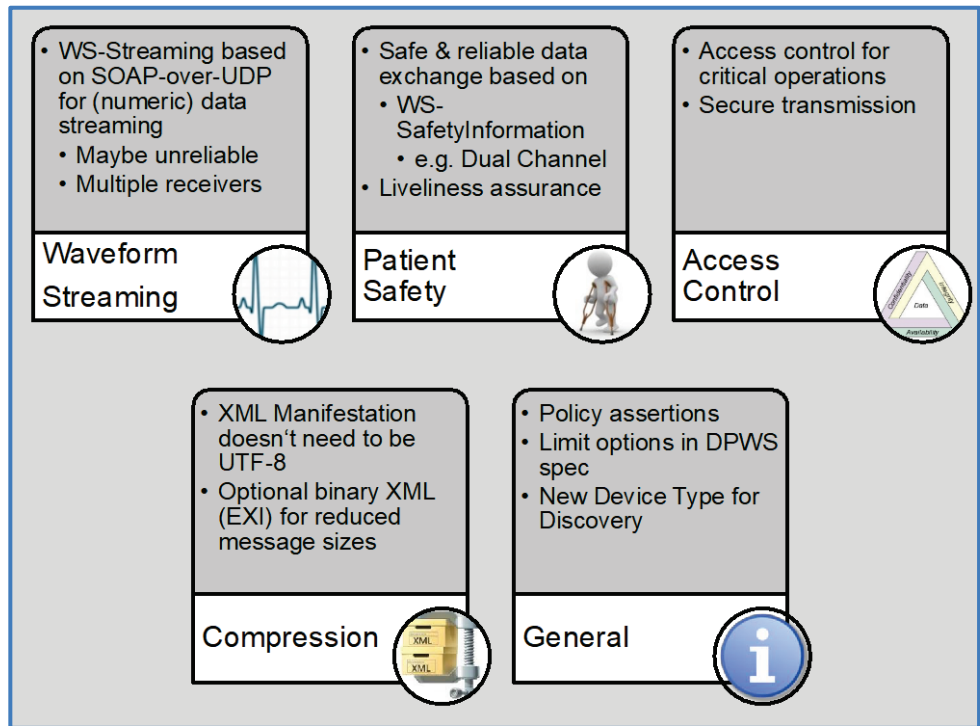

Figure 28 MDPWS Extended Capabilities

1570 Each of these areas of extension are of vital importance to medical devices deployed in high-acuity environments, especially addressing patient safety requirements and real-time needs related to waveform streaming and data compression.

1575 As is true with the BICEPS and SOMDA standards, MDPWS includes implementation conformance statement (ICS) tables that call out mandatory and optional capabilities provided by a specific device implementation. These include general WS-* messaging (e.g., SOAP-over-UDP), streaming support, safe data transmission support, compact representation and security. Again, any SDPi profiling must address both mandatory and optional implementation capabilities, including identifying those that are out-of-scope for SDPi implementations.⁴⁴

8.7.4 WS-* Profiles: IHE ITI vs. SDC's MDPWS

1580 It should be noted that IHE ITI defines a WS-* Profile specification in IHE ITI TF-2x Appendix V, which is also referenced in IHE PCD TF-2 Appendix J. As explained in C.2.1 General Device Data Reporting, the ITI WS-* Profile is an optional transport for the IHE PCD DEC Profile. This DEC option is used by the HIMSS/PCHAlliance Continua “WAN” specification for personal health devices, as well as the PCD DEC Profile testing regularly performed by IHE

⁴⁴ This is similar to the HL7 v2 ORU^R01 profiling for the IHE PCD DEC profile where a number of message segments and fields are simply out-of-scope when the message is being used to convey device reported information.

1585 Korea. MDPWS is a very different WS-* Profile, with much different intended use and design requirements, and care should be given to prevent any confusion between the two.

8.7.5 SDC Discovery & Service-based Exchange Examples

The following diagrams in this section provide sequence diagram examples of devices and applications that use SDC to discover, associate/bind, exchange information and invoke services.

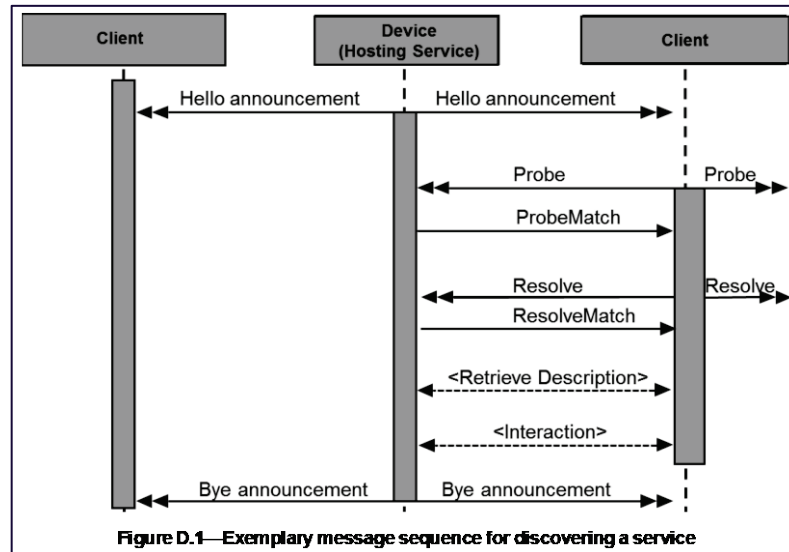

1590

Figure 29 SDC Basic Discovery & Exchange

1595 In the above example, a single device (SDC Service Provider) is connected to a network with two possible client systems (SDC Service Consumer). To support “implicit” discovery, the device automatically publishes Hello and Bye announcements, for which any interested Client system can listen. “Explicit” discovery is supported by Client devices issuing a Probe message indicating what services they are looking for. The Host Device can monitor these Client Probe messages and respond when appropriate. Both approaches result in dynamic discovery and association. See BICEPS discovery model for more information.⁴⁵

1600 Note that the Service Registry component identified in *Figure 16 SOMDA Conceptual Model* above, can be implemented as a centralized registry as implied by the conceptual model, or as a “distributed” registry architecture, which is more generally the case for SOMDA implementations. In the example above, each service provider “publishes” its capabilities either implicitly or explicitly, and each service consumer “finds” the desired services either implicitly or explicitly. This distributed registry approach allows for the ability of SDC networks to scale from very simple single device-to-device connectivity, up to a SOMDS with 100 internetworked devices and applications.

1605

⁴⁵ IEEE 11073-10207, section 9. Discovery Model.

The next example illustrates a physiological monitor that provides real-time patient vital signs information to a smart app.



1610

Figure 30 Example: Smart App & Vital Signs Monitor Discovery

The last example illustrates SDC subscription services between the same physiological monitor and smart application in support of a remote-control service invocation.

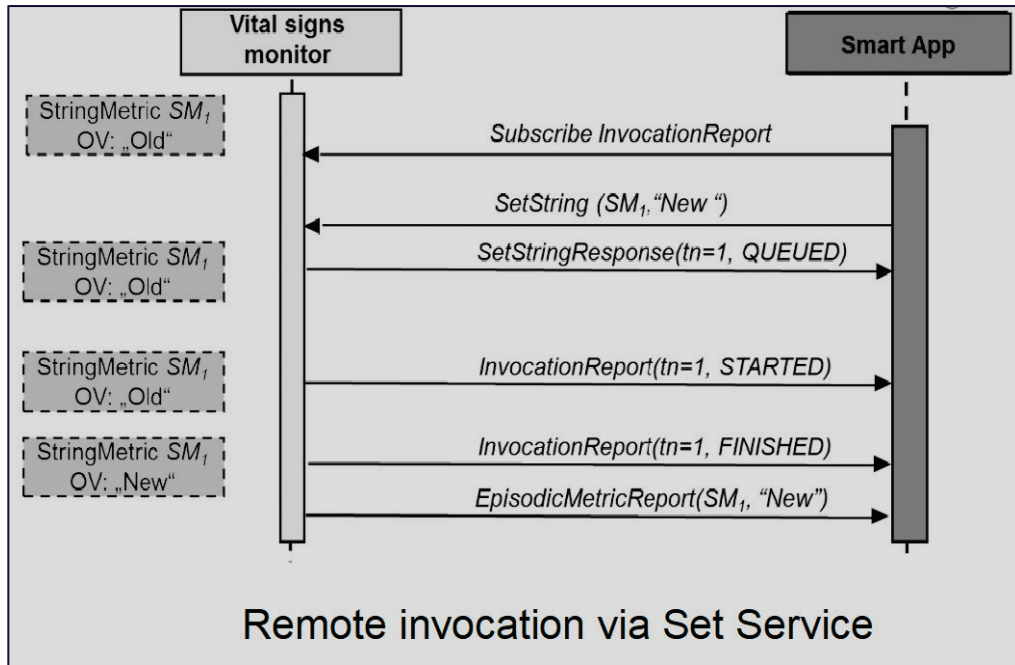

1615

Figure 31 Example: Remote "Set Service" Invocation

1620

In this example, the application subscribes to all "InvocationReport" updates, and then sets the value of a specific string metric to "New". The subscribed reports are automatically sent indicating when the service request was queued, initiated and completed. Ultimately, the device reports episodically the new value of the string metric that was changed, closing the loop for the application that the requested operation was actually completed.

9.0 General Profiling Considerations

1625 Everything preceding this point in the document has laid the foundation needed to consider
specific recommendations for integration of SDC into the IHE PCD Technical Framework. This
section establishes some core perspectives that apply to the PCD TF in general, as well as the
subsequent activities such as connectathon and conformity assessment testing, and public
demonstrations, and product certification. The following Section 10 makes specific SDPi Profile
proposals. Both of these sections, 9 and 10, complete the runup to Section 11 *Roadmap &*
1630 *Timeline*.

9.1 General Connectivity to Device Specializations

SDC provides a comprehensive standards-based PoC MDI solution supporting all the capabilities
that are currently provided in proprietary company-specific protocols, as well as the hooks to add
support for next generation technologies including AI/ML-powered medical “apps” and real-time
1635 execution and management of therapeutic and clinical workflow protocols. This includes basic
discovery and association services, to device reporting, alerting and external control. It includes
waveform streaming, safe and secure transmission and even capability extension for those
services that are not yet or possibly so unique they will never be standardized. SDC does this in a
way that addresses DPI security and regulatory challenges, as well as scaling from simple single
1640 device-to-device connectivity, up to a large, diverse array of medical technology supporting high
acuity patient care at the bedside.

Thus the challenge for integrating SDC into IHE technical framework components is to
determine what aspects should be added where and how. What should be part of a core profile
and what should be optional? Where should the integration begin, what should be next, and what
1645 might “end game” success look like. This subsection addresses a number of topics related to the
general aspects of SDC interoperability and the path to specific device specializations, all
supported within the IHE PCD TF.

9.1.1 Rationale for Path to Device Specializations

1650 Currently, the IHE PCD technical framework contains profiles that are mostly focused on the
basic integration challenges of reporting device information to enterprise applications (DEC) or
distributed alert management (ACM), or even general semantic content via the harmonized
Rosetta / RTMMS specifications. In most cases, though, these are all device agnostic with a set
of profile actors, actor roles and inter-actor communication transactions that support all PoCD
1655 devices, from simple spot-check vital signs monitors to physiologic monitors and ventilators
with 100’s of parameters each. The exception are infusion pumps, with the PIV and IPEC
profiles, although these are only at the enterprise level – to an infusion pump vendor’s gateway.
This functionally-focused simplicity, however, enabled rapid adoption and implementation by
the technology development community.

1660 Early IHE PCD Connectathon testing focused on validating the technical (e.g., transport) and
syntactic aspects of an HL7v2-based ORU^R01 message exchange. Later, general semantic
validation was performed, ensuring that the content included in the message was conformant to

1665 the “harmonized” Rosetta value set, which spans the entire space of PoCD devices addressed by the IEEE 11073 nomenclature standards, and the semantic constraints contained in TF-2, including verification that a given HL7v2 message segment – and field contained the right set of IEEE 11073 terminology values.

1670 The IHE PCD TF-3 Semantic Content volume includes high-level device-specific information models that have emerged from decades-long device modality standardization efforts. In Section 7.4.2 *Proposed NIST Framework Integrating SDPi Support*, a second generation of the NIST RTMMSv2 tool is discussed including support for the creation of device model templates, both for device component modules as well as entire devices (MDS specifications). It was noted that the tooling for the BICEPS-based device profile tool was in active development, as well as other elements of that tooling framework.

1675 The SDC standards identified in *Figure 18 IEEE 11073 SDC Family of Standards (“Cathedral Window”)* includes active projects for standardizing SDC modules in the IEEE 11073-107xx range, and the IEEE 11073-104xx standards have addressed personal health device (PHD) specializations that are currently implemented, certified and in active use.

1680 When viewed from a clinical perspective, each device fulfills a specific set of intended key purposes that come with their own set of “transactions” and associated value sets necessary to achieve the anticipated functionality in patient care. For example, all devices may use an IHE [PCD-01] (DEC) transaction for reporting content, but the value set for a specific device such as an infusion pump will be constrained, and further constraints and extensions might be added for specific infusion pump modalities, such as LVP, syringe or PCA. When alerting, a device can use an IHE [PCD-04] (ACM) transaction for reporting; however, the actual semantic content will differ greatly between a monitor, ventilator or pump.

1685 Given that SDC enables the integration of all the equipment and applications around a patient’s bedside, this differentiation is even greater, as is the need for a path to standardized device-level interoperability specifications.

1690 The proposal herein recognizes the natural extension of the current IHE PCD TF function-focused profiles to not only add general SDC-based interoperability capabilities, but to anticipate a future set of IHE PCD TF device specialization profiles that will build on the standardized connectivity solutions to define device-specific profiles, with actors, transactions and value set bindings (both to the device and individual transactions) that more closely address real-world use and future highly integrated medical algorithms and clinical protocols.

1695 Though this future vision of IHE profiles for device specializations and interoperability at the medical protocol level seems to some a distant “not in my lifetime” dream, it is in active research and in some cases technology development around the world. To anticipate how this evolution would be accommodated in an standards-based technical framework and architecture(s) is sequitur and responsible to the global MDI community.

The rationale for establishing a path to IHE PCD device specialization profiles, thus includes:

- 1700 1. **Increased Interoperability Maturity & Safety** – more precise specifications, reduced (unnecessary) optionality, and device-type variability, especially when they can be validated in real-time, leads to higher levels of care quality, safety and interoperability
- 1705 2. **Simplifies User Adoption** – Currently, an end user who wants to specify IHE-based interoperability for a new medical technology purchase, has to include a laundry list of profiles, profile options, and other capabilities that may / may not be in scope of what they need to acquire; IHE PCD device specialization profiles would ultimately simplify this process by delivering products that can boast “Certified IHE Syringe Infusion Pump”, significantly reducing confusion and increasing confidence in adoption and use of IHE-enabled technology.
- 1710 3. **Consistent Device “View” Across Use Contexts** – Device specialization profiles would not be SDC-specific but would use the interoperability technology appropriate for their use context; in the case of the *Example: Preeclampsia During Pregnancy Across the Continuum of Care* use case above, the same device modality might be used in hospital, home, and clinic contexts, all sending monitored information regarding the pregnant mother to the same cloud-based care coordination / decision support system.
- 1715 4. **Encourages Innovation Across Ecosystem** – For many medical device innovators, especially at the sensor or component level, implementing DPI is a daunting and often “existential” challenging; being able to integrate in a DPI framework that supports device specialization modules that can be leveraged from an open source community (e.g., via NIST’s RTMMSv2 or open SDC on Source Forge or GitHub), and easily extend them and contribute back to the community ... this would lower a perennial barrier to market entry.
- 1720 5. **Establishes Device Building Blocks for Clinical & Therapeutic Protocols** – As discussed above, once interoperable device module profiles are established, these can be leveraged by a new generation of clinical-context aware algorithms and protocol execution applications that are agnostic regarding specific device make/model configurations.
- 1725

9.1.2 Approach for Device-specific Profiles

1730 The conceptual approach for adding device specialization profiles to the IHE PCD technical framework is relatively straightforward:⁴⁶

PCD TF-1 Profiles defined for specific device modalities:

- ✓ Use cases illustrating operational modalities specific to a given device type, characterizing the external interactions required to accomplish a given device purpose, as well as any use context variations

⁴⁶ Note previous IHE PCD work around DPI profiling as well as infusion pump specializations (LVP, syringe & PCA) were the source of the basic approach outlined here.

- 1735 ✓ Actors, device-specific transactions, value sets (both at the device and transaction level) needed to accomplish the device functionality
- ✓ Device-specific baseline functionality + optional capabilities, including use-context specific profile bindings (DEC or SDC-based reporting)
- 1740 **PCD TF-2** Given that most general purpose transactions are specified in the TF-1 foundational profiles such as ACM or SDPi-Alerting, there may be little additional required in TF-2 to support device specializations.
- 1745 **PCD TF-3** Device specific containment model hierarchies are already provided in the Semantic Content TF volume 3; these are at the complete device level (e.g., ventilator) and not the more constrained value sets that might be bound to a device’s specific operation or purpose built transaction; note that computable value sets are highly important as illustrated in *Figure 12* – the TF-3 content will be at a higher level than the granular computable specifications contained in the RTMMSv2 database and conformant profiles specified in a Device Profile builder.
- 1750 **RTMMSv2** Device specialization modules (e.g., value sets & containment hierarchy) and integration with Device Profile builder tools that can be used to build conformant and executable specifications.

1755 In previous considerations around infusion pump specializations, levels of device specializations were also considered – a *specialization hierarchy*: General device, general infusion pump, LVP infusion pump, etc., allowing the increased level of specialization to leverage (or inherit) that which is common at more general levels.

Of course, this is all requires investment of time and resources that are in turn based on interest and market need ... globally. That said, the path forward is not rocket science! ⁴⁷

9.1.3 SDC Device Specialization Examples

1760 The following graphics illustrate how device specialization might be achieved using the IEEE 11073 SDC family of standards. See *Figure 18 IEEE 11073 SDC Family of Standards (“Cathedral Window”)* for the overall standards relationship picture.

1765 In the first example, *Figure 32 Example SDC Device Specialization - High-Frequency Surgery Device*, the general class of device is specified in a forthcoming 11073-1072x standard, and is an SDC SERVICE PROVIDER inheriting capabilities standardized in the 11073-1071x standards for reporting, alerting and controlling. These in turn are founded on the 11073-10700 Key Purposes standard, which establishes the linkage from the core SDC interoperability standards (BICEPS, SOMDA & MDPWS) to the specializations.

1770 Note the importance of maintaining this path – though given the paragraph above the “overthinking it” complexity question might definitely be raised. The rationale for this organization is to ensure requirement traceability, including non-functional patient safety and

⁴⁷ In recognition of the 50th anniversary of the Apollo 11 landing and man’s first steps on the moon.

security requirements, from the device specialization’s intended use (key purposes) all the way down to the WS-* function that is used to implement the needed communication.

1775 The *HF Device “A”* not only supports reporting of its operational parameters and signaling of any alert conditions, but it also provides an external control interface (“ExternalControlProvider”) that enables other systems to remotely change its operational parameters, such as frequency setting.

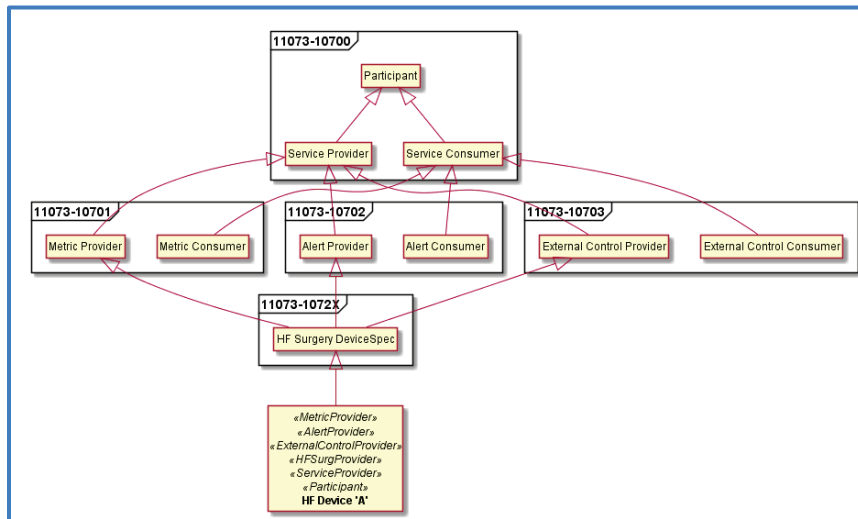

Figure 32 Example SDC Device Specialization - High-Frequency Surgery Device

1780 The next example device specialization, *Figure 33 Example SDC Device Specialization – Gateway & “Smart” Devices*, is for a “smart” device. The Enterprise Gateway SDC PARTICIPANT acts as a Service Consumer on the SDC PoC network side, and then can be coupled with another IHE profile actor (e.g., DEC:DOR or ACM:AR) to effect the communication to the enterprise. The Smart Display “consumes” device parametric (metric) and alert information from SDC PARTICIPANTS, integrates it and presents it to care staff
 1785 “intelligently” based on PoC context awareness. Finally, the Smart Control device consumes metric and alert reporting from other connected systems, but also the invocation of services (ExternalControlConsumer), allowing it, for example, to execute a closed-loop control algorithm that controls one or more devices based on the metrics and alerts from other devices. Smart!

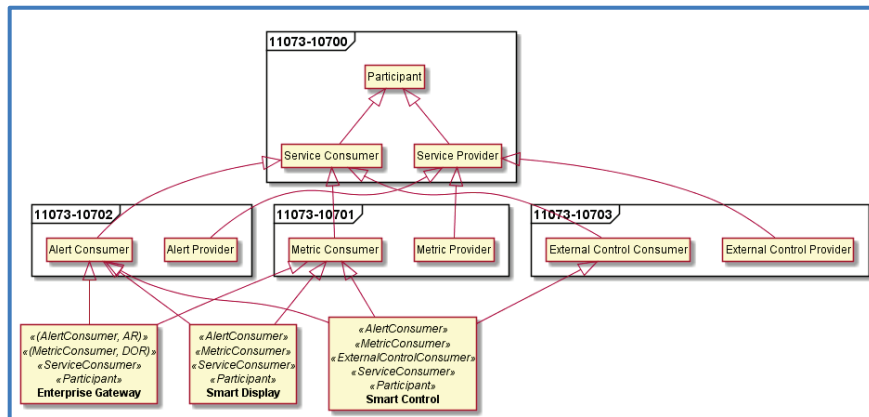

Figure 33 Example SDC Device Specialization – Gateway & "Smart" Devices

1790

In the above device specialization example, all three modalities could be combined into a single device MDS specification, providing the clinician with an intelligent user interface that both presents information integrated from multiple sources as well as controls that can be selected to change a networked device's parameters, or the operational settings on an integrated CLC algorithm. Again: Smart!

1795

9.2 The Holistic Interoperability Pitfall

Holistic = everything now and future proofed – bits and pieces are a non-starter!

1800

Standards-based profiling ... standards development in general ... is a process of gives and takes, stakes in the ground here, compromises there – sausage making – to arrive at consensus on an agreed solution for a problem. Many times, though, the end result is something that does not support the landscape of functionality that is needed in real-world use. As a result, systems developers are driven to either provide feature-reduced standards-based connectivity, feature-complete vendor-specific connectivity, or a mix of one and the other ... confusion and definitely not interoperation.

1805

Historically, the IEEE 11073 "classic" standards that supported real-time plug-and-play interoperability, did not support external device control or "symmetric" relationships, where the system both provided and consumed information from other systems, but promised that they were coming. Indeed, control was a core component of the 11073-10201 Domain Information Model standard. Thus, when the core 11073 "classic" standards were published internationally (11073-10101, -10201, -20101, etc.) they were sufficient for basic reporting and alerting implementation but didn't solve all of a vendors interoperability needs ... *holistically*. As a result, when implementers realized they couldn't do in a standards-based path what they were already achieving with proprietary protocols, they decided to wait until the *whole package* was ready to go or user demand mandated completion. "Wait" = forever

1815

Conclusion: SDC Core supports the required capabilities of DPI today. The remaining functionality painted in *Figure 18 IEEE 11073 SDC Family of Standards ("Cathedral Window")* are approved and funded (EU) IEEE 11073 projects. Open source libraries and tooling

1820 are in place and being extended. Integration of SDC into IHE PCD TF needs to leverage the existing standards and implementation support, as well as paint a clear roadmap for how the next parts will be integrated as quickly and seamlessly as possible. The window of opportunity is narrow:

BEWARE: THE HOLISTIC INTEROPERABILITY PITFALL!

9.3 Time Synchronization Challenges

1825 Coordinated time could be argued as the most central system capability enabling true interoperability. Within secure exchange, time synchronization is a core requirement. From a medical care and clinical operations perspective, time coordination is also key to interpreting any monitored patient information and providing therapy, whether it is the interpretation of real-time physiologic patient vitals collected from multiple medical devices or the timing for the next drug dose. For this reason, ALL IHE profiles across all subject domains are dependent on the Consistent Time (CT) Profile.

1830 Time synchronization in IHE and SDC and generally throughout industry, is based on Network Time Protocol (NTP) and Simple NTP (SNTP)⁴⁸. Technical details for IHE CT Profile are provided in the ITI TF-2a, Section 3.1 ITI-1 *Maintain Time* transaction, and a profile option is provided for secure NTP and secure SNTP. UTC is used as the common reference point.

1840 Note that the synchronization precision must be less than one second; however, “The specific precision of synchronization depends upon the requirements of specific actors”. In the case of patient care devices, both PoCD and PHD, there are additional challenges resulting from legacy technology that had no support for time synchronization to highly resource constrained devices that simply provide an internal timestamp counter, relying on a receiving system to correlate the timestamp counter with a real-world synchronized time. There are time zone challenges, especially with technology that provides no support for managing localization, including where the information may be used in telecare applications across broad geographies.

1845 A full exploration of these issues around MDI is beyond the scope of this short white paper; however, the intent is to leverage the excellent and extensive work that has driven both standardization and implementation activities.

1850 IHE PCD requires all profile actors to be “grouped” (or paired) with CT to ensure that all communication is properly time synchronized and timestamped⁴⁹. IHE PCD TF-2, appendix B.8 includes a more extensive set of specifications for the inclusion of time synchronization information in the HL7v2 ORU messages used by the IHE PCD technical framework:

B.8.7 Time Stamps and Time Synchronization

B.8.8 Device Time Synchronization Capabilities

⁴⁸ See IETF RFC1305 & RFC4330 for technical details.

⁴⁹ See IHE PCD TF-1, Table 2.5-1 profile dependencies.

B.8.9 Device and/or DOR Synchronization Protocol

1855 The following table provides an example of the time synchronization options supported by the IHE PCD TF HL7v2 messaging profile:

Table B.8.8-1: OBX-5 Values for Device Time Synchronization Capabilities

OBX-5 values (one or more ...)	Description
<0 or 1>^nds-time-capab-real-time-clock(0),	device supports an internal RTC
<0 or 1>^nds-time-capab-set-clock(1),	device supports Set Time Action
<0 or 1>^nds-time-capab-relative-time(2),	device supports RelativeTime
<0 or 1>^nds-time-capab-high-res-relative-time(3),	device supports HighResRelativeTime
<0 or 1>^nds-time-capab-sync-abs-time(4),	device syncs AbsoluteTime
<0 or 1>^nds-time-capab-sync-rel-time(5),	device syncs RelativeTime
<0 or 1>^nds-time-capab-sync-hi-res-relative-time(6),	device syncs HiResRelativeTime
<0 or 1>^nds-time-state-abs-time-synced(8),	AbsoluteTime is synced
<0 or 1>^nds-time-state-rel-time-synced(9),	RelativeTime is synced
<0 or 1>^nds-time-state-hi-res-relative-time-synced(10),	HiResRelativeTime is synced
<0 or 1>^nds-time-mgr-set-time(11)	manager is encouraged to set the time

Figure 34 IHE PCD Time Synchronization Capabilities

1860 In the table pictured in the figure above, note that Relative & High Resolution Relative Time⁵⁰ refers to device-internal counters that are relative to some event, either system start-up for a general timestamp, or to express other elapsed inter-event time periods. Absolute time represents time-of-day settings. Note that the subsequent Table B.8.9-1 *OBX-5 Values for Device and/or DOR Synchronization Protocol* includes whether the medical device has an internal clock, whether it was set “EBWW” (EyeBall and WristWatch), or whether it used other means such as NTP, SNTP, Bluetooth (Medical Device Profile), or even GPS.

1870 SDC also supports strong time synchronization capabilities as well as a BICEPS MDIB Clock object, as indicated in *Figure 23 SDC Medical Device Information Model*, that supports extensive time capability semantics and services, as well as a Timestamp data type⁵¹. In SOMDA Section 10.3.1 *Clinical effectiveness – Time synchronization*, requires the use of NTP v3 (or greater) to meet the synchronization requirements in BICEPS. Note that “SNTP... has drawbacks regarding temporal correlation of data due to possible jumps in time. Therefore it is not recommended in an SOMDS.” Note that the BICEPS Clock descriptor does allow for

⁵⁰ In IEEE 11073-10207, the time stamps are accurate to within 8 kHz (125 μSec) and 1 MHz (1 μSec) respectively.

⁵¹ In BICEPS, the Timestamp data type is at 1ms resolution and if used, the device must also support the Clock object descriptor, enabling consuming systems to understand the quality of the time data being communicated.

indication of how the time was set, including whether a synchronization protocol such as NTP or SNTP or even EBWW was utilized.

1875 **9.4 Device ID & Configuration Management + FDA UDI Challenges**

1880 In recent years, the visibility of the importance for unique device identification – both of the device type as well as the specific device instance– has increased with the FDA and IMDRF focus on “UDI” as a key safety mechanism for managing device safety challenges and incident reporting around the world⁵². Although support for standardized UDI representation has been added to standards such as HL7v2 PRT Participation segment and HL7 FHIR Device resource, its implementation and use in the real-world remains a challenge. The IHE PCD TF also addresses the communication of unique device identifiers, such as the FDA UDI or IEEE EUI-64, in section *B.10.2 Future PRT segment use to support Unique Device Identifiers in the PCD Profiles*, especially in the *PRT-10 Participation Device* and *PRT-16 Participation Device Identifier* message segment specifications.⁵³

1890 Related to this is the need for a device instance to be able to communicate its configuration, both software and hardware, facilitating biomedical equipment management activities, especially in response to recalls or security update requirements. This has been a key capability of the IEEE 11073-10201 “classic” domain information model MDS object, as well as the 11073-20601 PHD protocol specification. Additionally, the Devices on FHIR implementation guides both for PoCD and PHD devices map provisions for device configuration information into the Device resource specification. A related topic especially in device cybersecurity discussions is the establishment of a Software Bill of Materials, enabling security monitoring technology to know what OTS software⁵⁴ is built into a device’s firmware, and thus which devices might be impacted when new vulnerabilities are discovered.

1900 SDC also provides strong support for both unique device identification as well as device configuration information disclosure, in accordance with the other foundational IEEE 11073 MDI standards. For example, the MDS object “MdsDescriptor” includes specifications for UDI (DeviceIdentifier, HumanReadableForm, Issuer, Jurisdiction) as well as manufacturer / model / serial / lot numbers and expiration date. Note that multiple UDI’s can be communicated by an SDC participant and the SOMDA specification includes a “PRIMARY UDI” specification for

⁵² For example, see <https://www.fda.gov/medical-devices/device-advice-comprehensive-regulatory-assistance/unique-device-identification-system-udi-system>.

⁵³ Note that in earlier applications of HL7v2 and the IHE PCD profiles, OBX-18 was used to carry the device identifier. This has been replaced by use of the PRT segment for more robust and standardized identification purposes.

⁵⁴ For example, many devices use “off the shelf” real-time operating systems (RTOS) optimized for embedded applications. Some even use embeddable versions of operating systems such as Microsoft Windows, which has in recent years resulted in major virus attacks and even “ransomware” vulnerabilities.

the overall device configuration. See SOMDA 7.5 *MDIB Versioning* for the use of FDA and EU “primary” UDI values to create a namespace UUDI.

1905 SDC BICEPS also defines a Device Component Descriptor that includes a Production Specification element that can be used to create a configuration list of device hardware / software.

9.5 Regulatory Requirements & Approach

1910 In addition to the verification of the stand-alone SDC Participant functionality, the verification of the System Function of each SDC-enabled product aims to achieve that the product works as intended in the expected context of use. This context of use comprises the Medical IT-Network⁵⁵ as well as other SDC-enabled products.

To this end, tests at different test levels are required as depicted in *Figure 35*:

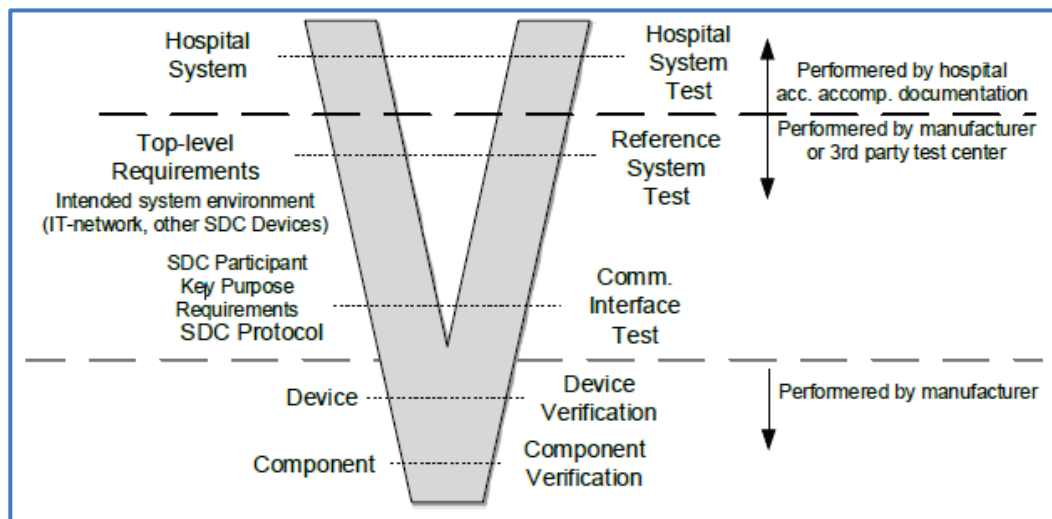

1915 *Figure 35 SDC "V" Model for V&V*

The verification against the specification of the System Function Contributions of the communication interface comprises that the SDC Participant under test has to prove that it’s IEEE 11073 SDC Communication Protocol interface is conformant to the IEEE 11073 SDC Communication Protocol as well as to all requirements of its SDC Participant Key Purpose.

1920 Showing conformance to IEEE 11073 SDC Communication Protocol is done by proving that either the SDC Service Provider or the SDC Service Consumer or both is implemented. The SDC Participant Key Purposes also specify how an SDC Participant shall behave under inopportune conditions (e.g., high load scenarios, loss or delay of data messages, data corruption, etc.), or in

⁵⁵ Per IEC 80001-1:2010, a general purpose I.T. network that includes connection of at least one regulated medical device. See section 9.7 *Safety Considerations* below for more detail.

1925 combinations of SDC Participants that perform according to their specification, but at the extremes of the acceptable SDC Participant behavior. Furthermore, the SDC Participant Key Purposes also specify how an SDC Participant shall behave under conditions outside the specification, e.g., extreme load scenario or undue request, shall demonstrate that such conditions do not result in hazardous situations.

1930 Verification of those requirements thus automatically results in showing that the SDC Participant is robust against network related extreme or error scenarios that might occur during real-world usage of the Medical Device.

See also the related “Test2Interface” SDC compliance check (SDCcc) tool in *Figure 13 Example of SDC Compliance Check Tool*.

1935 In addition to this, the SDC Participant has to demonstrate its capability to perform its System Functions and System Function Contributions in a Reference System (Reference System Test). This Reference System is made up of real SDC Participants which complement the SDC Participants System Function as well as a simulated SDC System to emulate a realistic use scenario. The Medical IT-network of the Reference System as well as the amount of simulated data traffic is chosen in accordance with the Medical IT-Network characteristics specified in the SDC Participants IfU. In addition to the functional tests, the verification of the SDC Participant has to include tests in which those network requirements are violated. In these cases, the SDC Participant has to go into a “safe state” where a potential loss of System Functions does not affect the SDC Participant’s stand-alone essential performance.

See also the related “Reference System” test setup in *Figure 15 Reference System concept*.

1945 In order to ensure that the intended System Function and System Functions Contribution is available in a specific SDC System, the verification by the SDC Participant’s Manufacturer must be complemented by verification activities of the Responsible Organization. These verification activities are specified in the accompanying documentation of the SDC Participants and may for example be required, during the system integration, periodically while the SDC Participant is in operation, following software updates, or following major changes of the Medical IT-Network.

1950 To summarize: *SDC interoperability provides traceability from bits “on the wire” to connectivity capabilities to the intended key purposes for which the device was placed into use on patients. Therefore, not only can interoperability risk mitigations be identified and implemented during system design and deployment, but the effectiveness of those mitigations can be monitored during real-time network use. Sweet!*

1955 **9.6 Security & Privacy Considerations**

1960 As mentioned above, medical device cybersecurity has been receiving increasing attention given the recognition that any connected device represents a potential vulnerability for an entire healthcare organization’s security infrastructure. Indeed, in recent years “MedJack” attacks have been documented where a device was compromised but not to compromise its use, rather to launch horizontal attacks against other parts of the hospital’s information infrastructure and connected systems (e.g., EHRs). A full treatment of the medical device cybersecurity topic is

beyond the scope of this document and indeed is rapidly evolving to meet the international threat that it represents.

1965 Since devices are part of the overall security infrastructure of an organization and their trust framework, much work has been done to ensure seamless integration so as to ensure safe, effective and secure operation of networked medical technology. The IHE PCD created a white paper on cybersecurity⁵⁶, and the IHE PCD TF-1 addresses security considerations with statements such as:

1970 “The current profile does not address issues of privacy, security, and confidentiality associated with cross-enterprise communication of PCD data. The assumption is made that the DEC Profile is implemented in a single enterprise on a secure network.”

This is in recognition that security within a given deployment environment is generally beyond the scope of PCD interoperability profiles and must be addressed at that enterprise live.

1975 Similarly, as seen in *Figure 27 WS-* Reference Profile Stack*, SDC leverages WS-Security specifications. Indeed security requirements are included in all three of the IEEE 11073 SDC Core standards to allow for secure transmission when appropriate for intended functioning of all SDC participants:

BICEPS 10.3 Cybersecurity Considerations

1980 Mandates the provision of confidentiality, integrity & availability (CIA) capabilities as part of the non-functional requirements section.

SOMDA 10.1 Cybersecurity & MDPWS 10 Security considerations

Detailed profile specifications for the use of

- a) IETF RFC5246 Transport Layer Security (TLS, ver 1.2);
- 1985 b) WS-I Basic Profile (v2.0 section 7 Security)
- c) OASIS DPWS V1.1, Section 6 (Security)
- d) OASIS WS-Discovery, Section 8 (Security)

1990 The use of WS-Security and TLS is consistent with other IHE profiles such as the ITI ATNA Profile and considerations outlined in the ITI security cookbook⁵⁷. Also, the HIMSS PCHAlliance “Continua” PHD specifications utilize the same WS-* security scheme for their

⁵⁶ See https://www.ihe.net/Technical_Framework/upload/IHE_PCD_White-Paper_MEM_Cyber_Security_Rev2-0_2011-05-27.pdf.

⁵⁷ See https://www.ihe.net/Technical_Framework/upload/IHE_ITI_Whitepaper_Security_Cookbook_2_008-11-10.pdf.

“WAN” interface. For additional perspective and challenges, see 8.7.4 WS-* Profiles: IHE ITI vs. SDC’s MDPWS.

1995 Related implementation questions are concerned with performance challenges, for example, with resource-constrained medical devices having to implement a TLS-based security scheme, or the potential variations around security certificate handling, both in terms of performance and jurisdiction. Then there is the whole question about addressing European GDPR requirements⁵⁸, which have had impact around the world, including networked medical technology. These are all topics that SDPi will address in its initial version but will also have to evolve as that part of the industry changes.

2000 The next section provides additional perspectives around security risk management within the context of medical system safety and effectiveness.

9.7 Safety Considerations & Risk Management Support

The interrelated ecosystem stakeholder relationships around MDI safety, effectiveness and security are well recognized, as illustrated in *Figure 36*:

2005

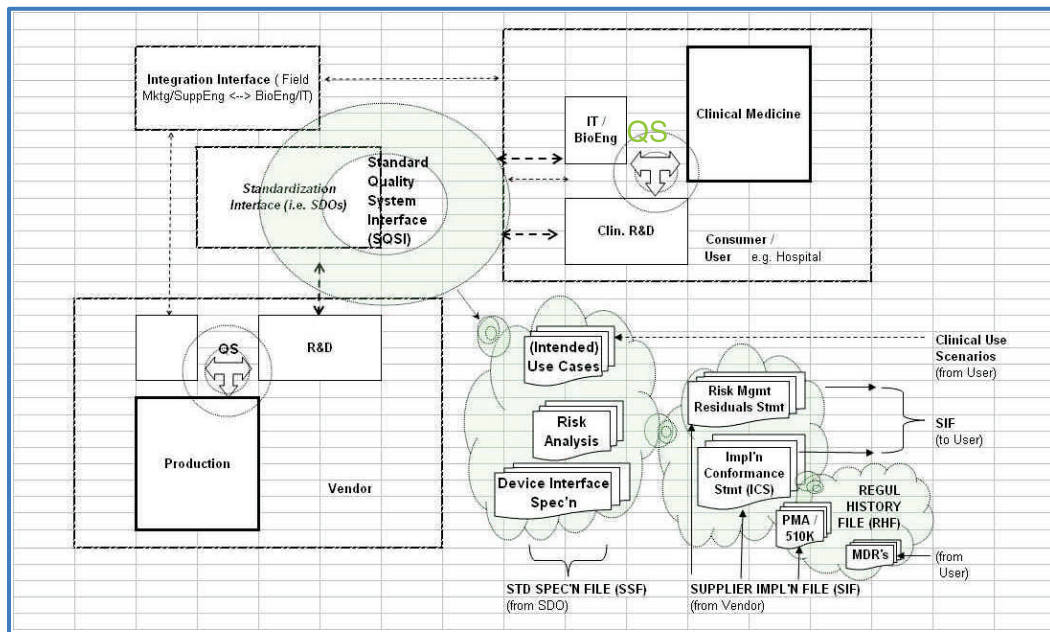

Figure 36 Proposal: Standard Quality System Interface (SQSI) Architecture for Risk Managed MDI⁵⁹

This “busy” model from 2007 illustrates how a quality system that comprehensively addresses risk management for medical technology must integrate stakeholders from clinical users, medical

⁵⁸ For General Data Protection Regulation (GDPR) see <https://gdpr-info.eu/> and similar.

⁵⁹ Source: Jan Wittenber, “X73-ICE – Control Use Cases Modeling”, 2007-05-06.

2010 technology developers / suppliers / vendors, standards developers (SDO), and regulators to analyze, specify and mitigate risks to safety and clinical effectiveness (intended use). Soon after the time this model was proposed, the ISO/IEC 80001 risk management standards were published, laying the foundation for leveraging the foundation of ISO 14971 medical device patient safety risk management, to address the broader topic of ensuring the *safety, effectiveness*⁶⁰ and *security of interoperable medical technology* when it is deployed in heterogenous contexts often using general purpose health I.T. infrastructure. A full treatment of the 80001 and related standards, is beyond the scope of this document; however, these informatics standards do establish the need for any MDI “from the device interface” solution to support risk management focused on safety, security and other non-functional requirements, of an interoperable device, to the mitigations that were implemented and their management during operational use.

2015

2020

See also Section 9.5 *Regulatory Requirements & Approach* above.

Recognizing this need, many of the IHE PCD profiles include an Integration Profile Safety and Security Considerations section.

2025

2030

2035

SDC also addresses safety as a core consideration that, like security, begins at the highest key intended purposes / device capabilities level. BICEPS includes safety-specific support throughout the standard, including in Section 10.2 *Nonfunctional requirements – Patient safety considerations*, which requires all implementations to support inter-participant authorization capabilities, as well as data integrity and loss of connection detection capabilities. A foundational “SafetyClassification” data element is defined that allows medical device manufacturers to indicate whether the associated data element is intended for informational (non-clinical functions), or medical “MedA / MedB / MedC care functions.”⁶¹ This allows SDC consuming systems to recognize and appropriately handle the information and services they are consuming. This SafetyClassification designation would be the direct output of risk analysis of the intended use of the device or application to provide high-acuity patient care.

The handling of safety-related information is of particular importance with any external / remote control capabilities, as described in SOMDA 7.2.1 *Remote-control capabilities description*, which provides extensive bindings to MDPWS *SafetyReq* and *SafetyContextDef* elements. MDPWS includes an entire Section 10 *Safe data transmission* as well.

2040

SOMDA adds some relevant definitions:

MEDICAL SAFETY CLASSIFICATION: Classification of the quality of data and criticality of operations from a risk management perspective in accordance with the

⁶⁰ In this context, “effectiveness” relates to the intended purpose of the interoperability aspects of a device or system, the specific functions that are enabled or impaired by the functioning of that interface, including both functional and non-functional requirements. Note also that “interoperability” is generally considered an “effectiveness” requirement and capability of a devices connectivity, and not a risk managed key property.

⁶¹ Defined in BICEPS: MedA = care support only such as display; MedB = used in clinical functions that could result in nonserious injury; and MedC = used in clinical functions that could result in serious injury or death. See also ISO 62304.

pm:SafetyClassification of a CONTAINMENT TREE ENTRY that evaluates to either “MedA,” “MedB,” or “MedC” as defined in IEEE Std 11073-10207-2017.

2045 **SDC PARTICIPANT KEY PURPOSE:** A set of requirements a Service-oriented Device Connectivity (SDC) PARTICIPANT is complying and that allows it to act in a SERVICE-ORIENTED MEDICAL DEVICE SYSTEM (SOMDS) accordingly.

2050 NOTE 1—An SDC PARTICIPANT KEY PURPOSE might be for example a set of requirements that guarantees safe and effective communication with for SDC PARTICIPANTS that participate in a SOMDS function, e.g., *closed-loop remote control between devices*.

NOTE 2—An SDC PARTICIPANT KEY PURPOSE might be for example a set of requirements that *guarantees safe and effective communication* with SDC SERVICE PROVIDERS that represent specialized clinical POINT-OF-CARE (PoC) MEDICAL DEVICE specializations contributing to functions in a SOMDS.

2055 NOTE 3—If an SDC SERVICE PROVIDER has more than one SDC PARTICIPANT KEY PURPOSE, then those SDC PARTICIPANT KEY PURPOSES cannot contradict as per definition the SDC PARTICIPANT has to comply with the superset of the set of requirements defined for each SDC PARTICIPANT KEY PURPOSE.

2060 SDC is clearly designed to be used for the most challenging high-acuity patient applications, addressing safety and other risk factors that are beyond those typically encountered at healthcare enterprise exchanges. The challenge for IHE SDPi profiling will be to integrate both this safety and related information, as well as the other effectiveness and security support elements to ensure the risk managed operation of the connected technology, from the patient through to enterprise applications.

9.8 Interoperability Maturity Models for SDC Roadmapping

2065 Maturity models have often been used to assess the capability progression of an individual, organization or even technology, from beginner to advanced to beyond-all-expectation. They also support separation of various aspects such that they can more easily be evaluated, as well as providing a pathway for improvement and ... maturity. This last element directly informs planning activities, including roadmapping as will be addressed below in Section 11 *Roadmap & Timeline*.

2070 9.8.1 Modeling Interoperability: Past, Present & Future

2075 This is true for interoperability in the healthcare domain, and for MDI in particular. Historically, HL7 broke interoperability into a three-level model: Technical, Semantic, Process. HIMSS built on this tripartite model and in January 2019 added a 4th aspect: Foundational, Structural, Semantic & Organizational.⁶² The widely recognized “Turnitsa” conceptual interoperability model⁶³ identified six levels and was leveraged in a 2012 AAMI Medical Device Interoperability white paper, per the following table:

⁶² See <https://www.himss.org/news/himss-redefines-interoperability>.

⁶³ See https://en.wikipedia.org/wiki/Conceptual_interoperability: No interoperability – Technical – Syntactic – Semantic – Pragmatic – Dynamic – Conceptual.

	Level	Turnista name	Short description	Standard or effort working to that goal	Interoperability achieved in market or in practice in market or in practice	Ecosystem components			
						Resources	Testing	Verification	Certification
Interoperability	5	Dynamic	Components internal states and capabilities understood	None					
	4	Pragmatic	Context understood	Continua	Multiple vendor PnP products on market	Design guidelines, reference implementations, testing tools, certification process	Continua	Continua	Continua, 3 rd party
				IHE PCD	Multiple vendor products on market	Profiles, implementations guide, user handbook	Connections, demonstrations	None	None
				ASTM F2761 (ICE)	Multiple vendor interoperable products in development	System architecture standard	Planned	Planned	Planned
Integratability	3	Semantic	Meaning understood	SNOMED	Numerous products on market				
				Continua/11073 Nomenclature	Multiple vendor products on market	Continua/Rosetta database	Continua	Continua	Continua, 3 rd party
				IHE-PCD/11073 Nomenclature	Multiple vendor products on market	IHE-PCD/Rosetta database	Connections, demonstrations	None	None
	2	Syntactic	Common format	HL7	Multiple vendor products on market. Not interoperable off-the-shelf	HL7 SDO published standards documents			
				11073 series	In use by all Continua products	SDO published standards documents (ISO, IEEE)			
Connectivity	1	Technical	Common physical and transport	Ethernet, WiFi, USB	Numerous PnP interoperable products on market	Design guidelines, reference implementation, development tools, mature supply chain	3 rd party or SDO/ consortium	3 rd party or SDO/ consortium	3 rd party or SDO/ consortium
	0	None	None						

Figure 37 AAMI 2012 MDI - Levels of Interoperability

2080 These models were further advanced by Ken Fuchs at the Center for Medical Interoperability (C4MI) in developing an interoperability model that would support their efforts:

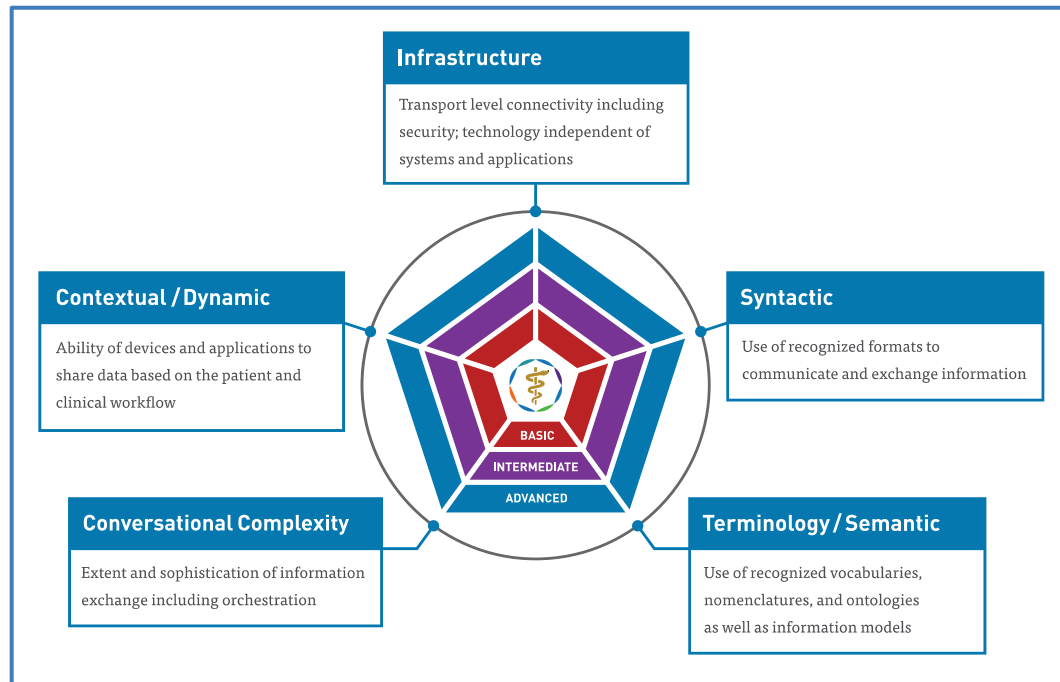

Figure 38 MDI Maturity Model (Fuchs/C4MI)⁶⁴

2085 **9.8.2 Assessing Standards Maturity & Fit for Purpose**

2090 “The best thing about standards is that there are so many of them!” As is true of good humor, there is a nugget of truth at the core, as is true of this oft repeated statement. In the area of health informatics and even the specialized area of medical device informatics standards. SDO’s have refined their new standards proposal process to require a market justification / analysis, hopefully giving all stakeholders pause at the start of standardization to ask the question, “Is this truly needed? Will it be used and provide the anticipated value?” This is a good start but as has been repeatedly stated above, although standards-based interoperability has a strong *technical aspect* as illustrated by the various perspectives in the preceding Section 9.8.1 *Modeling Interoperability: Past, Present & Future*, the implementation and active use of standards-based technologies in daily care remains primarily a *business challenge*.

2095 Remember that this is the objective of the IHE process as detailed in Figure 2 *IHE Process: From Standards to Products to Improved Healthcare*, connecting real-world opportunities and problems to the standards-based solutions that can be implemented to improve the lives of patients and their care givers. IHE has a model for indicating the maturity of a given interoperability profile specification⁶⁵, with “maturity” meaning: Readiness to be implemented and placed into active healthcare use:

⁶⁴ Presented by Ken Fuchs (C4MI) at ACCE/AAMI 2016 Conference & Expo, Tampa, Florida.

⁶⁵ For more information, see https://wiki.ihe.net/index.php/Profiles#Symbols_Key.

Development	When an IHE interoperability profile begins development as a supplement to a domain’s <i>technical</i> framework, early drafts might be available for prototyping and plug-a-thon type testing, especially to validate alternative standards and design approaches.
Public Comment	The domain committee has finished primary editing and is ready for broad review and feedback, before “freezing” the draft and proceeding to formal IHE Connectathon testing.
Trial Implementation	Frozen specification ready for prototyping, Connectathon and project testing; however, changes may be made to correct issues or add needed capabilities.
Final Text	Stable, fully tested, ready for use in production systems and for implementation and patient use; this stage includes the need to have multiple successful IHE Connectathon testing events. ⁶⁶

2105 Additionally, standards and profiles may be “deprecated” when, for example, they have been replaced by other specifications. For example, ITI’s XDS.b Profile replaced the original XDS. Also note that some IHE profiles that pass Public Comment and make it to Trial Implementation never progress further, especially if they are not fully tested at IHE Connectathon events, indicating that developers are not ready or no longer see the market need.

2110 Note that C, which has many elements that are “normative” (ready for production product use) as well as specifications that are in the earliest stages, has defined a FHIR Maturity Model (FMM)⁶⁷ that specifies seven maturity levels, from (0) Draft to (6) Normative. Each step identifies the specific process steps that have to be achieved to progress from creative concept to stable standard.

2115 Finally, in the public government space there is a clear need to determine which standards fit the identified needs and are stable and implemented sufficiently to warrant government recognition, recommendation, and required use in eHealth projects. In the United States, the Office of the National Coordinator for Health Information Technology (ONC) annually publishes an

⁶⁶ “Successful” includes at least 3x3 testing, where every profile transaction is tested at an event where three different developers provide systems for each of the communicating actors; in other words, Developer A performs each Connectathon test with 2-3 different vendors.

⁶⁷ See <http://hl7.org/fhir/STU3/versions.html#maturity> for more detailed information. A related article about the intersection of FMM and IHE profile maturity is discussed by John Moehrke, see <https://healthcaresecrecy.blogspot.com/2017/04/reflecting-fhir-fmm-in-ihe-profiles.html>.

2120 Interoperability Standards Advisory (ISA⁶⁸) that leverages a maturity and fitness scheme for evaluating standards maturity.⁶⁹ The ONC ISA leverages criteria and metrics originally advanced by JAMIA, as summarized in *Figure 39 Standards Readiness Model for National Adoption (JAMIA)* that illustrates the relationship between standards technology maturity and adoptability as a national standard.

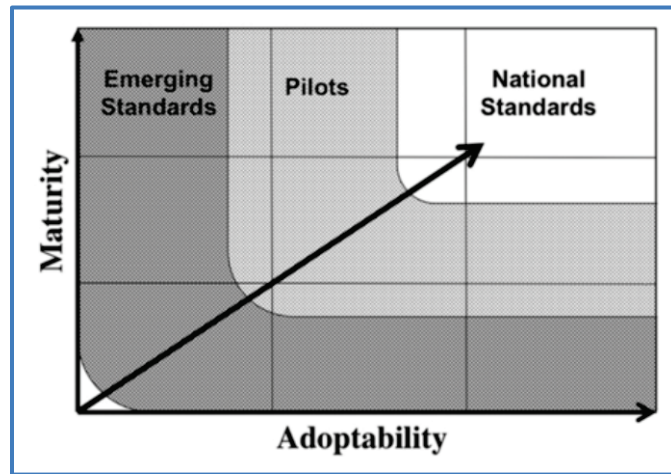

Figure 39 Standards Readiness Model for National Adoption (JAMIA)⁶⁹

2125 Many other efforts around the world have been pursued in recent years to address this general challenge, including standards such as ISO/TC 215 TR 14639-2 *Health informatics - Capacity-based eHealth architecture roadmap - Part 2: Architectural components and Maturity model*. The European Union Horizon 2020 eStandards project advanced a multi-stakeholder multi-SDO “co-creation” / Governance / Alignment process that leverages open eHealth “Base Standards” to
 2130 create and deploy and manage “standards sets” that address specific public digital health infrastructure needs.

⁶⁸ See <https://www.healthit.gov/isa/>.

⁶⁹ See Halamka, et al., “Evaluating and classifying the readiness of technology specifications for national standardization”, JAMIA, 2015-June; <https://academic.oup.com/jamia/article/22/3/738/771667>. Copyright Oxford University Press (<https://doi.org/10.1136/amiajnl-2014-002802>).

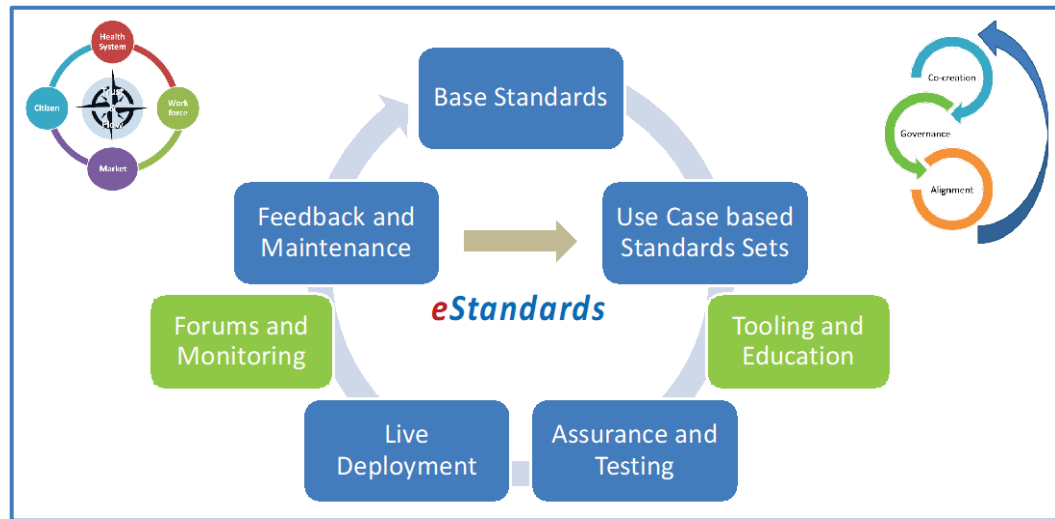

Figure 40 European Horizons 2020 eStandards "Maturity" Process

2135 9.8.3 MDI “State of the Union” Maturity & IEEE 11073 SDC

2140 Although there are many MDI standards at various stages of maturity from initial development (e.g., IoT or DoF) to emerging to stable and established to irrelevant and deprecated, the reality remains that today there is no true medical device interoperability “from the device interface” in products actively used for patient care. When considering that there are 1,000’s of semi-standard and vendor-specific protocols used for DPI, even reducing this number to a handful of use context-specific options would mark a drastic improvement and contribution to the community. Indeed, providing a realistic maturity assessment and roadmap forward is key for enabling both developers and users / purchasers to have the confidence that a standards-based MDI technology is sufficiently mature and “real” to invest their time and resources.

2145 The IHE PCD profiles are the one bright light in the MDI community enjoying broad adoption and use for integration of device reported information at the enterprise level. Recognizing a standard’s maturity capabilities and level as established, for example, by the Fuchs model in *Figure 38*, and coupled with the overall IHE process model in *Figure 3*, lays the foundation for determining the road ahead for integrating SDC interoperability standards into the IHE PCD technical framework.

2150

SDC is an “emerging” standard ready for “trial implementation” when considering the following:

1. Technology Maturity

- ✓ Underlying WS-* is in extensive use around the world
- ✓ SDC leverages many decades of knowhow regarding connectivity of medical technology in high-acuity environments
- ✓ SOA architectures are widely used in digital platforms around the world, including safety-critical and secure applications

2155

2. Standardization Maturity

- 2160 ✓ SDC Core standards (BICEPS, SOMDA, MDPWS) are published by IEEE and ISO/CEN and have been implemented in real-world products
- ✓ Eleven IEEE SDC standards projects (*cf. Figure 18*) have been approved and will provide the additional capabilities
- ✓ SDC IEEE standards are based on the highly mature IEEE 11073 “classic” MDI standards, especially for semantic content (11073-1010x and 11073-10201).
- 2165 ✓ A robust comment / change proposal process is in place (via Source Forge) to support maintenance activities related to the published standards, with project team members meeting frequently to review and disposition the comments.

3. Community Maturity

- 2170 ✓ Many academic and public / industry programs (*cf. Figure 41*) have resulted in a strong technical community supporting SDC interoperability
- ✓ Numerous open source libraries, reference implementations and demonstrations are freely available on-line
- ✓ This community, though, is primarily European-based, especially in Germany, and includes technical, clinical and regulatory experts, among others
- 2175 ✓ SDC is now beginning to build an international community, including engagement at ISO/TC 215 meetings, as well as the U.S., Australia, Korea and other countries

4. Use Maturity

- ✓ SDC is “real” – in other words, regulated medical device technology that is SDC-enabled is in active use on patients in high-acuity healthcare contexts
- 2180 ✓ SDC is rapidly advancing the regulatory approval for additional devices and applications both in Europe as well as in the U.S.

2185 The following *Figure 41* illustrates the nearly 15 years of research & development projects that have matured the standards and underlying technology to the point where in 2019 the first SDC-enabled medical devices were cleared in Europe for patient use and will be submitted soon to other regulatory bodies such as the U.S. FDA.

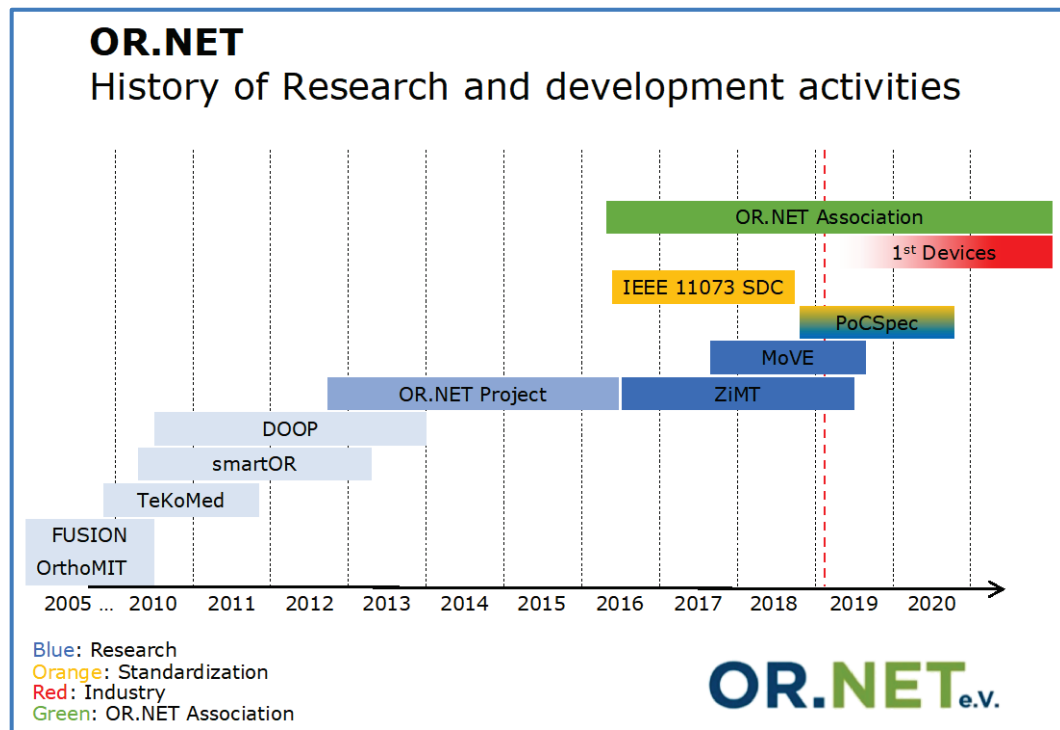

Figure 41 SDC R&D History⁷⁰

2190 From a Fuchs’ interoperability model perspective, SDC addresses capabilities along all five axes, supporting Basic to Advanced functionality. Considering the breadth of SDC capabilities for realizing true MDI in high-acuity care contexts, determining where to start ... and then what?! ... is daunting. These models provide a basis for rationalizing the development of an SDC to IHE SDPi integration, to achieve comprehensive, wholistic PoCD interoperability.⁷¹

2195 **9.9 Considering Additional Integration Architectures – RESTful, DDS, ...**

2200 As has been pointed out in numerous places above and as illustrated in *Figure 20 SDC Point-of-Care Gateway to Hospital Enterprise Systems*, high-acuity point-of-care environments such as OR ICU also interact with other network environments and systems. IHE “grouped” actors can act as gateways between different architectures and protocols, as will be proposed below in *Section 10.2 Volume 1: Interoperability Profiles*.

One of the RESTful architectures of current interest is HL7 FHIR, which supports four architectural paradigms: RESTful, Document, Messaging, and SOA. The Devices on FHIR (DoF) group, composed of individuals in HL7 Health Care Devices, IHE and

⁷⁰ Source: “SDC Overview” presentation to FDA, Dr. Stefan Schlichting & David Gregorczyk, April 2019.

⁷¹ They may also provide the basis for developing an MDI cross-standards model based on ISO (draft) IS 23903 Health Informatics – Interoperability Reference Architecture.

2205 HIMSS/PCHalliance, has made great progress in mapping the IEEE 11073 “classic” PoCD and PHD models into the FHIR Resource model, and specifically the RESTful services paradigm. The task of defining a gateway Actor between SDPi/SDC and DoF/FHIR should be relatively straightforward given the progress to date. See Section 10.1.6 *Integration with Devices on FHIR™ Implementation Guidance* for more information.

2210 Another observation is that though SDC interoperability can address the comprehensive needs of medical devices around a high-acuity PoC, there are other technologies currently deployed that leverage either proprietary company-specific protocols or semi-standard communications (e.g., a standard such as WS-* or CANbus, but with some “secret sauce” that render them ... non-interoperable). One of these is DDS, Object Management Group (OMG) Data Distribution Service.⁷² The question is whether and to what degree of difficulty could SDC and DDS enabled technologies interoperate, ostensibly through a thin gateway actor.

2215

To investigate this, a project at the University of Lübeck⁷³ was undertaken in 2018 to determine whether DDS could be used as an alternative implementation platform in place of WS-* and MDPWS, meeting the requirements of BICEPS and with minor, systematic updates to the binding “glue” of SOMDA. The approach taken was to use the open source SDCLib implementation and replace the MDPWS components with DDS substitutes. See *Figure 42* and *Figure 43* below:

2220

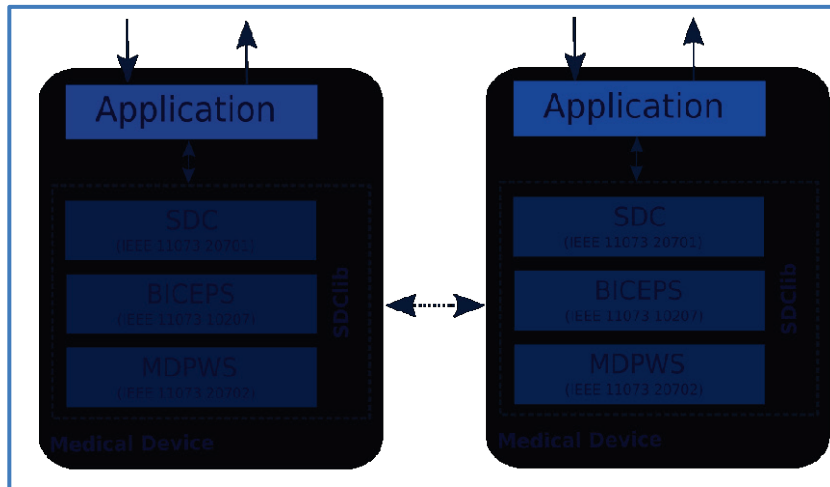
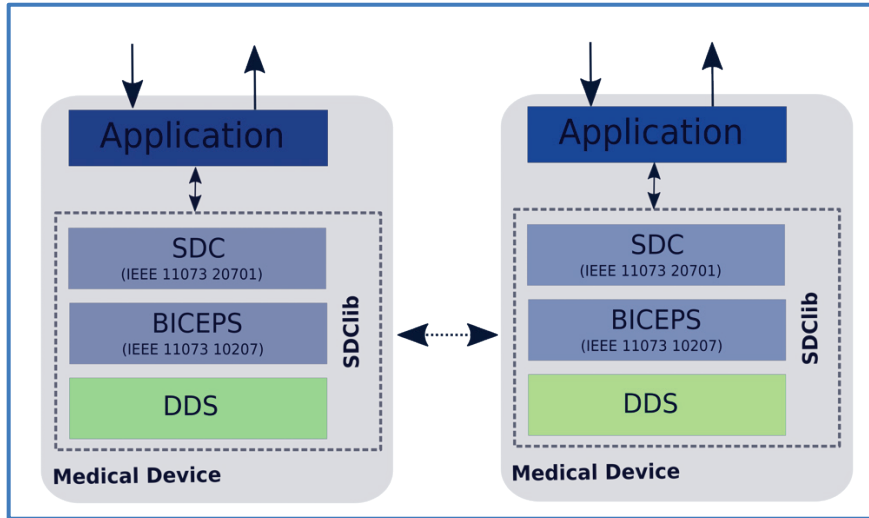

Figure 42 SDC Library - MDPWS Connectivity⁷³

⁷² See https://en.wikipedia.org/wiki/Data_Distribution_Service.

⁷³ Source: “Using Data Distribution Service for IEEE 11073-10207 Medical Device Communication”, Merle Baake, 2018.



2225

Figure 43 SDC Library - DDS Connectivity

2230

The referenced paper from Merle Baake recounts the success of the project, including how QoS, topic mapping/filtering were accomplished in an SDC / BICEPS architecture. Though it is still to be determined whether this will be a real-world implementation requirement, the feasibility and residual challenges have been established and portend well for integration of BICEPS & SOMDA with other platform technologies and gateway protocols.

10.0 SDPi: Integrating SDC into IHE Technical Frameworks

2235 With the preceding overviews of general device interoperability challenges, SDC connectivity standards and IHE technical frameworks and development processes, this section brings it all together, proposing specific recommendations for integration of SDC-enabled device-to-device connectivity into the IHE PCD technical framework. The first section provides broad-brush approaches for various topics, with subsequent sections providing specific content proposals for each volume. The intent is that the content below will form the basis (e.g., word-for-word) for the content of the first supplement draft documents.

2240 10.1 Technical Framework Approach

10.1.1 Use Cases & Requirements

2245 Informatics standardization should always be rooted in real-world scenarios that paint a clear picture of both the interoperability objectives and challenges for a specific application or use, as well as the intended future state. All IHE profiles include such an exemplary set of use cases, the analysis of which allows identification of actors, actor roles, exchanges or “transactions” between actors, etc. In the area of device-to-device acute care contexts, extensive use case analysis has been performed over the last 3+ decades. Clearly, there is no need to redo all this excellent work; rather, this white paper identifies relevant sets of these use cases that have focused on medical device interoperability (See *Appendix D – Compendium of Medical Device Oriented Use Cases* for details).⁷⁴

2255 The four examples below were selected due to either their direct informing of the general SDPi architecture discussion, or because of their “relevance” due to current industry activities and technical directions. Each example includes a general system context diagram that illustrates what is contained in an SDC network and what interacts with it, as well as a dynamic behavior diagram. The dynamic behavior builds on the basic device-to-device connectivity functions of discovery and association (DnA), and in some cases service Subscription, to various uses of services for reporting, alerting and external control. All of these are core capabilities intended to be provided by the IHE SDPi profiles.

Example: Functional Endoscopic Sinus Surgery OR Integration

2260 The following example use case narrative illustrates a typical use of SDC-based interoperability in a high-acuity healthcare context:

John Miller (13yrs, m) has chronic rhinosinusitis, which is an inflammatory condition in which the nose and his left maxillary sinus is swollen and the drainage of the mucus is

⁷⁴ Note: Additional analysis of the use cases below and in the Appendix is the beyond the scope of this white paper; however, would provide valuable insight and value to the MDI community overall. For example, each use case could be assessed for which functional area(s) they support (basic connectivity, device identification, configuration (hardware & software), reporting, alerting, external control, automation / closed-loop control, diagnostic/ therapeutic multi-device coordination, clinical workflow automation, etc.). Ultimately, this would facilitate application of development of MDI architectures that meet specific needs as identified in real-world applications.

- 2265 *prevented. John’s chronic rhinosinusitis doesn’t respond to medication anymore. After consulting with his physician, he and his parents decide to resolve the issue with a Functional Endoscopic Sinus Surgery (FESS). The FESS will be done in as a day surgery, so that John can get home in the evening.*
- Before the day of the surgery, a CT scan is taken that is used to guide the surgeon during the surgery.*
- 2270 *In order for the surgery to start, John is put under general anesthesia and monitored with a patient monitor by a pediatric anesthesiologist, esp. his mean arterial blood pressure which has been reduced in order to provide optimal visibility of the surgical field due to reduced capillary bleeding.*
- 2275 *During the intervention, the Surgeon has a constant view of the patient's vitals (including MABP) and the control functions to execute the intervention.*
- During the procedure one of the surgical devices has a technical issue. It generates a technical alert which notifies the responsible biomedical technician. He/she decides to replace the device and connects it to the network where it is automatically discovered and configured allowing the intervention to continue.*
- 2280 *There are no additional technical or clinical problems, the surgery is a success and John can go home with his parents.*

This narrative includes the following component use cases:

- [SDC/FESS.1](#) Surgeon view of patient vitals
- [SDC/FESS.2](#) Surgeon control of OR table and lights
- 2285 [SDC/FESS.3](#) Surgeon control of surgical tools
- [SDC/FESS.4](#) Device reports technical issue to responsible BMET
- [SDC/FESS.5](#) Seamless exchange of Medical Devices

2290 The following further illustrates the potential application of SDPi to each of these component use cases:

SDC/FESS.1 – Surgeon view of patient vitals

2295 In this case, a surgeon desires to use a single user interface on an endoscope that displays monitored patient information from one or more networked devices. A key point here is the independence of these two systems. The endoscope can display the information retrieved from a broad range of patient monitoring devices, as opposed to the need to be paired with a specific device.

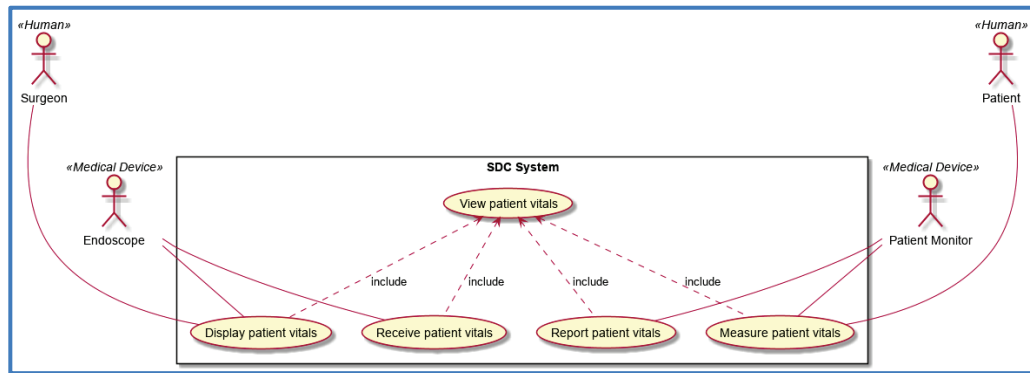

Figure 44 FESS-1: Surgeon View of Patient Vitals - System Context Diagram

2300 The view of patients’ vitals by the surgeon is split up into four dedicated use cases:

1. Measure patient vitals
2. Report patient vitals
3. Receive patient vitals
4. Display patient vitals

2305 The dynamic behavior of the actors is depicted in Figure 54. Note the device-to-device direct communication between the patient monitor and the endoscope. This allows the surgeon to focus on a single endoscope display, as opposed to scanning between 2+ device displays to synthesize a clear picture of the patient and surgical context.

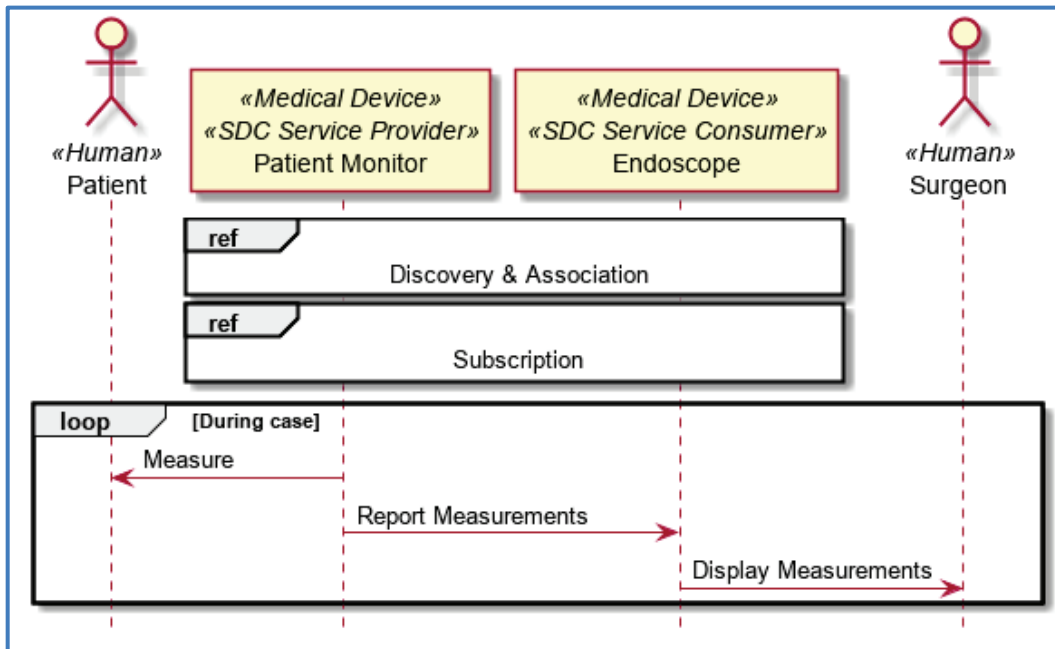

Figure 45 FESS-1: Viewing Patient Vitals by a Surgeon – Dynamic System Behavior

2310

SDC/FESS.2– Surgeon control of OR table and lights

The second FESS use case focuses on a surgeon’s control of one device through the user interface of another:

2315

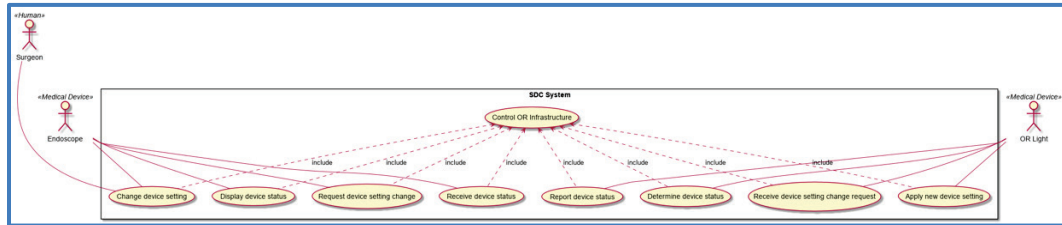

Figure 46 FESS-2: Surgeon Control of OR Light - System Diagram

The control of a device like an OR Light by the surgeon is split up into eight dedicated use case:

1. Determine device status
2. Report device status
3. Receive device status
4. Display device status
5. Change device status
6. Request device setting change
7. Receive device setting change request
8. Apply new device setting

2320

2325

The dynamic behavior of the FESS-2 actors is depicted in *Figure 46*.

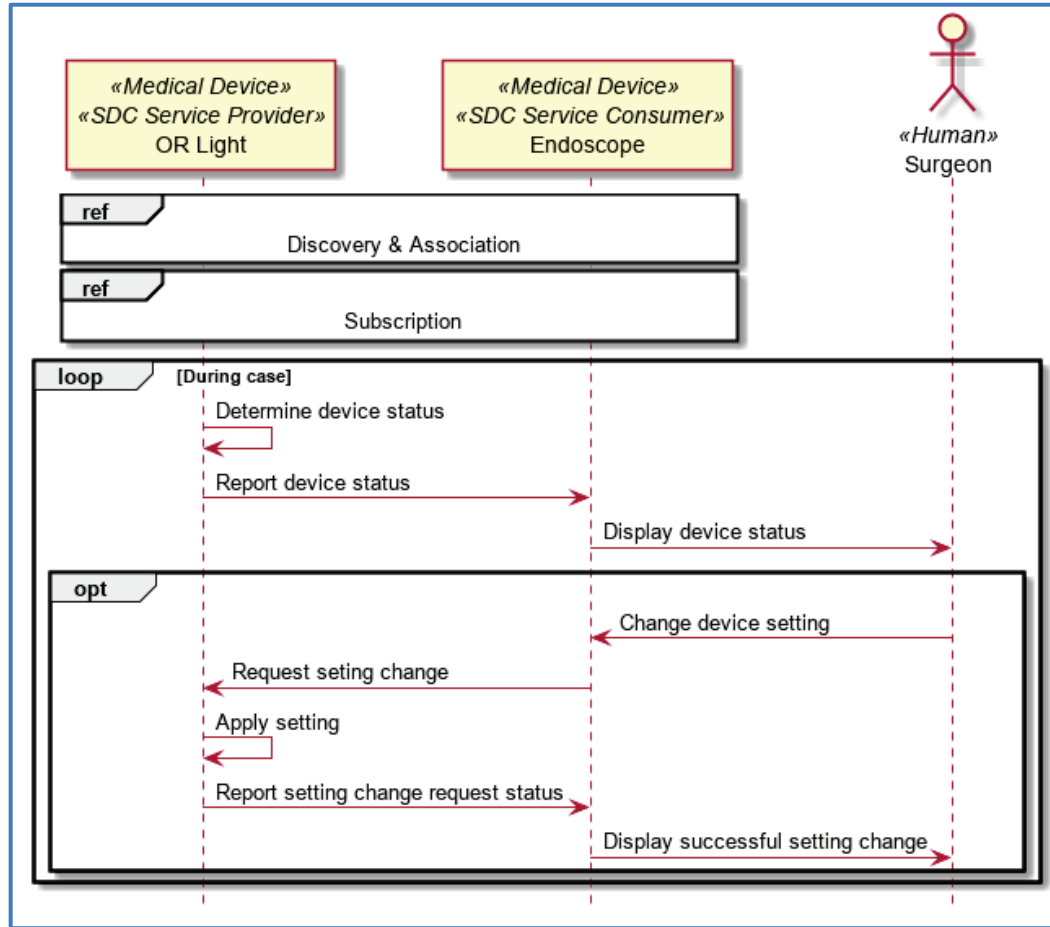

2330

Figure 47 FESS-2: Surgeon Control of OR Light – Dynamic System Behavior

Again, note the device-to-device integration with the endoscope, enabling the surgeon to not only view the patients monitored information in real-time on the scope display, but also enabling him to adjust the operating room light for better viewing – from the same, single user interface.

2335

Consider “heads up” VR / MR / AR⁷⁵ displays that would implement the same SDC system participant model. Further a MR display that supports one surgeon at the bedside and a consulting surgeon at distance ... potentially a great distance!

SDC/FESS.4 – Device reports technical issue to responsible BMET

2340

The next two diagrams, *Figure 48* and *Figure 49*, illustrate how biomedical engineering staff can be notified automatically when a problem is detected and reported by an SDC system component:

⁷⁵ Virtual Reality (VR), Mixed Reality(MR), Augmented Reality(AR).

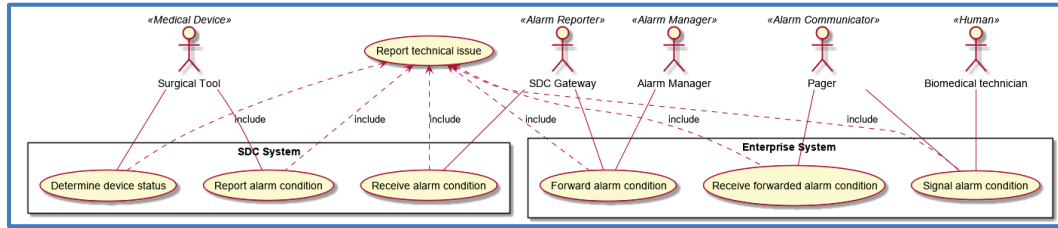

Figure 48 FESS-4: Technical Alert to Biomedical - System Context

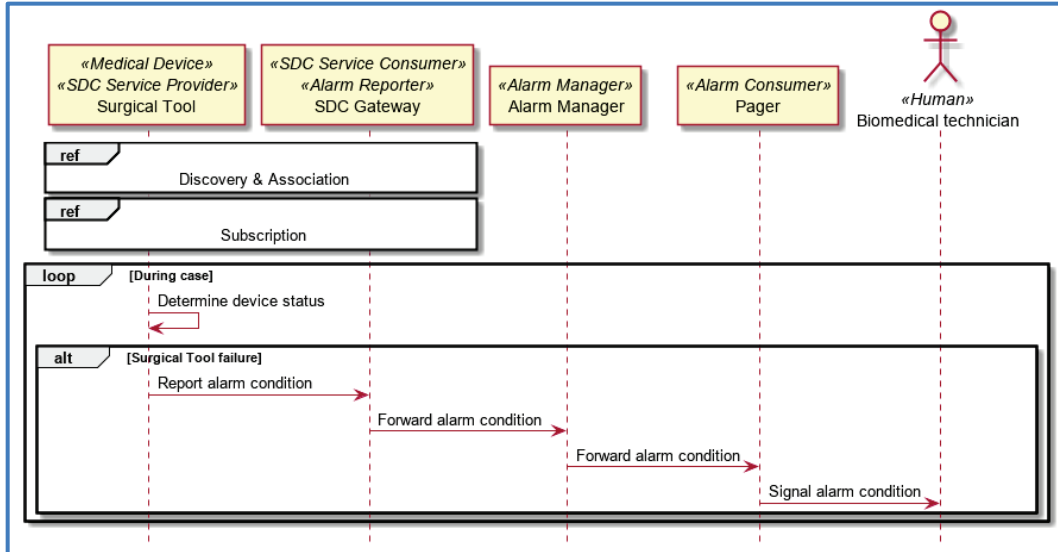

Figure 49 FESS-4: Technical Alert to Biomedical – Dynamic Behavior

2345

Consider the time savings that could be realized with this integrated notification of clinical technology management when there are issues during care delivery – especially in OR, ICU and ED.

SDC/FESS.5 – Seamless exchange of Medical Devices

2350

When equipment failure is identified to biomedical staff, per FESS.4 above, depending on the criticality and patient safety impact, the medical device could be replaced “seamlessly”, as illustrated in Figure 50 and Figure 51.

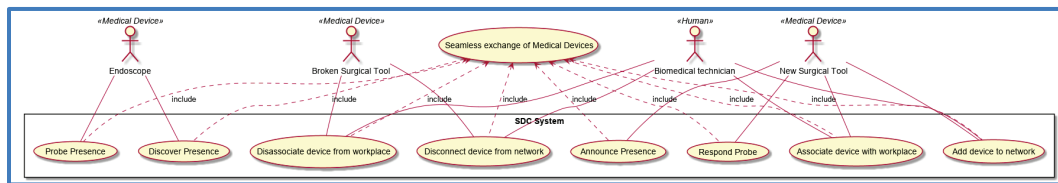

Figure 50 FESS-5: Seamless Exchange of Medical Devices - System Context

2355

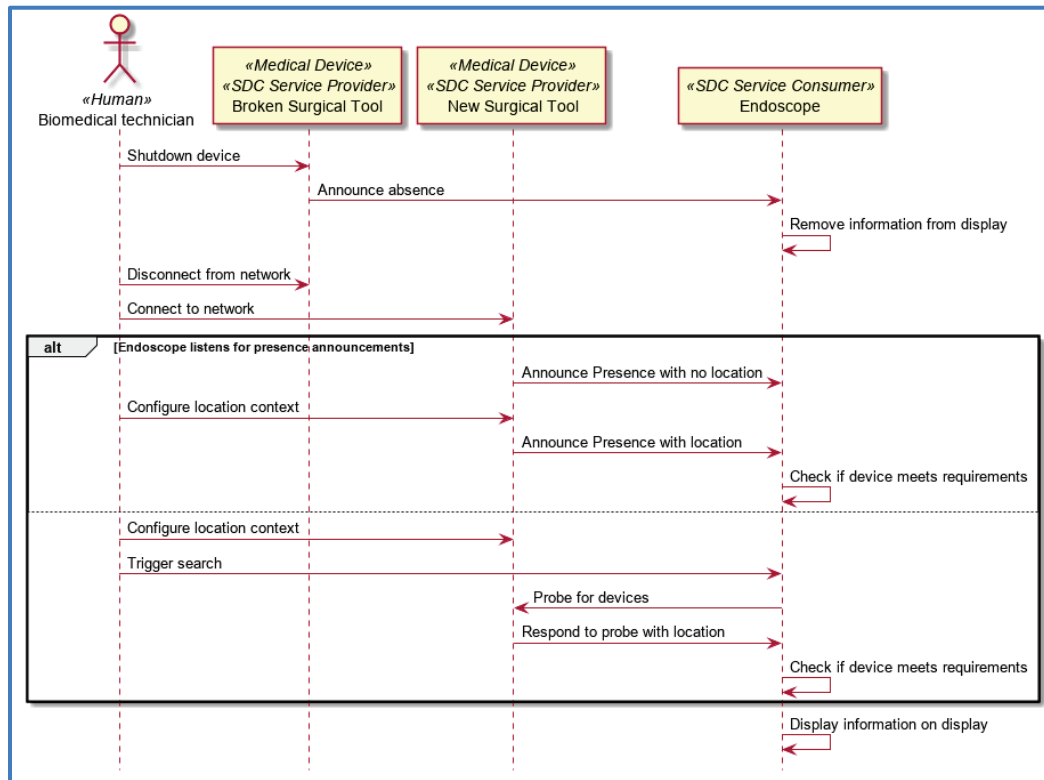

Figure 51 FESS-5: Seamless Exchange of Medical Devices – Dynamic System Behavior

Given that clinical technology / equipment management systems are deployed in a non-SDC, enterprise context, this use case would also leverage the IHE PCD ACM interactions as illustrated below in Figure 54 SDC "Quiet Hospital" Interaction Diagram and above in Figure 20 SDC Point-of-Care Gateway to Hospital Enterprise Systems.

Note that this could also be extended to support the “hot swapping” use case called out in Section 0 Example: NITRD ‘19 MDI Use Case below. One of the additional challenges in the “hot swapping” use case is the need to be able to restore the “new” replacement device to the same operational point as the previous device when it was removed from service. For example, an infusion pump that is delivering a specific drug amount and is ½ way through that infusion therapy protocol, would need the replacement pump to resume delivery at the same point.

10.1.1.1 Example: NITRD ‘19 MDI Use Case

In mid-February 2019 the Networking and Information Technology Research and Development (NITRD) sent out a Request for Information on “Action on Interoperability of Medical Devices, Data, and Platforms to Enhance Patient Care”. The RFI requested feedback on their future vision on Medical Device Interoperability. This vision was expressed in the form of the following scenario:

When people with serious injuries or illness are hospitalized medical device additions and changes are automatically recorded with no deficit in patient safety, loss in data

2380 *fidelity, or data security as the patient transitions across the continuum of care. Additional medical devices can be added or removed as the patient's status changes and details of these changes, calibration of the instruments, and each equipment's unique device identifier [UDI] and configuration settings are recorded and synchronized. If a piece of equipment breaks, it can be switched seamlessly with a device from another vendor. Data and settings from patient medical devices, such as insulin pumps, are identified, integrated, and time synchronized, and select data are included in the electronic health record. As autonomous capabilities are added, real-time care is logged, and supervisory control established to ensure the provision of real-time patient*

2385 *monitoring and support. When providers are not available, or have competing demands, medical devices will function in a closed loop, autonomous manner with appropriate safety and control measures to stabilize the patient. Data will flow through changes in equipment that occur in moves from the emergency room, to the operating room, to the intensive care unit, to a rehabilitation facility, and finally to the home. This will allow for data and metadata to flow even as changes in equipment are mapped to individual patient needs and environment. Each change in equipment configuration will be noted in the supervisory system/medical record and in the metadata (e.g., the UDI) generated by the device. The resulting patient record from these systems will include device data, metadata, and care documentation. These patient records can be stored and analyzed using medical black box recorder-equivalents to assess adverse events or examine unexpected positive outcomes. This will also improve the consistency and quality of care; create real-time automated care systems; create a learning health system.*

2390 *These types of records and the real-time systems interactions they enable are widely used or are being actively developed in other industries, such as the industrial controls and autonomous systems in the automotive, aviation, and energy sectors. That is not the case for healthcare. While there are many factors that may inhibit real-time interaction in a medical setting, interoperability solutions that are relevant for healthcare and patient safety need to be developed. Seamlessly flowing, interoperable data from medical devices and systems, when utilized effectively, could significantly enhance patient outcomes, identify and reduce errors, enhance the efficiency of care delivery, reduce development times and costs, improve standardization/consistency of care delivery, and decrease healthcare provider burnout.*

2395

2400

2405

For the purposes of our use case analysis this Future Vision has been organized into 7 Use Cases as follows:⁷⁶

- 2410 NITRD.1 – Seamless changes of medical devices
- [NITRD.2](#) – Capture of data and settings
- NITRD.3 – Supervisory control established

⁷⁶ Analysis provided by Ken Fuchs; see [Appendix D – Use Case Collections](#) for additional information and correlation with OR.net use cases 140 — 146.

[NITRD.4](#) – Autonomous patient therapy

NITRD.5 – Data flows through the Continuum of Care

2415 NITRD.6 – Capture of equipment configurations

NITRD.7 – Black Box Recorder

2420 A workshop was organized by the U.S. FDA in conjunction with the Health Information Technology Research and Development (HITRD) Interagency Working Group (IWG).⁷⁷ This “listening session” workshop on “Interoperability of Medical Devices, Data, and Platforms to Enhance Patient Care”, is intended to advance standards-based medical device interoperability (MDI) addressing topics such as data & meta-data, device control, autonomous care delivery, device informatics standardization, architecture, infrastructure, tools, etc.

2425 The following use case examples further illustrate the potential application of SDPi to the NITRD event objectives and scenario. Note that NITRD.1 is covered by [FESS.5](#) above, and NITRD.3 by [FESS.2](#).

NITRD.2 – Capture of data and settings

This use case illustrates how three SDC interoperable medical devices can act as service providers, reporting data to an SDC-DEC gateway⁷⁸, that “bundles” the captured device data and reports it out to enterprise systems, including EMRs.

⁷⁷ See <https://www.nitrd.gov/nitrdgroups/index.php?title=Medical-Device-Interoperability-2019> (last accessed 2019.06.22).

⁷⁸ See *10.2.2 Profile: SDPi-R* for Reporting for more detail around an SDC-DEC gateway actor.

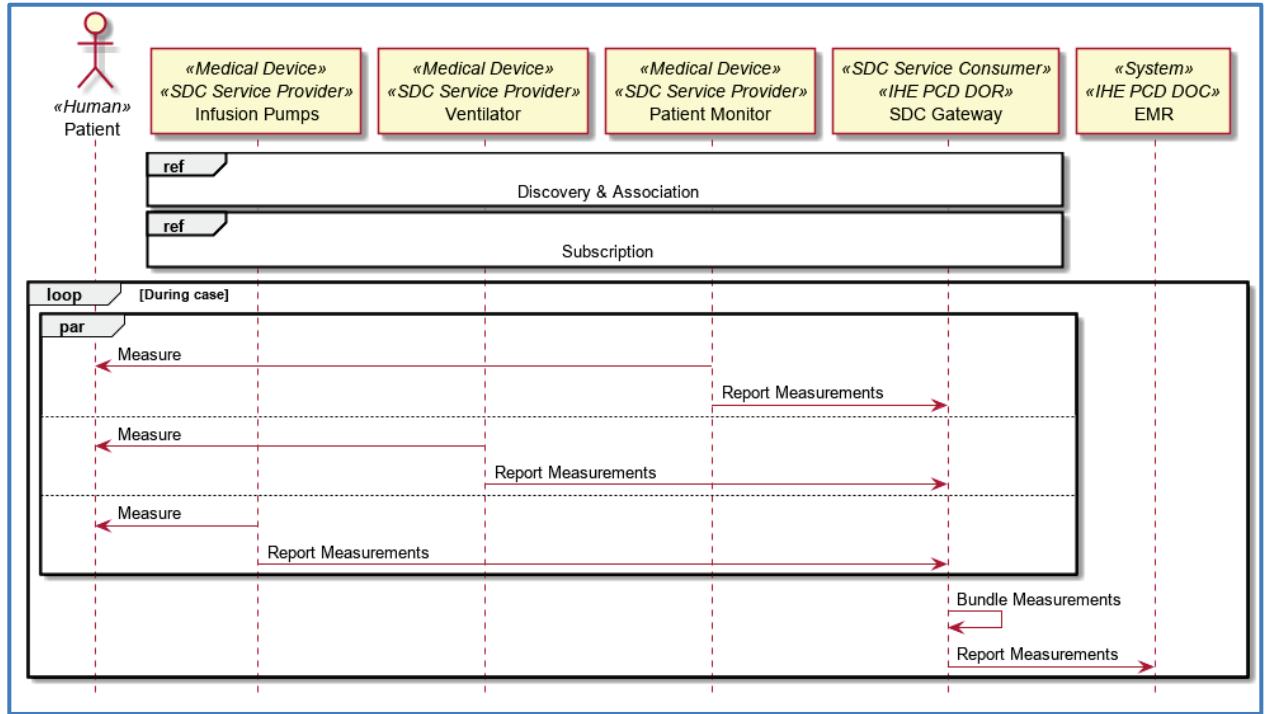

2430

Figure 52 NITRD-2: Capture of Device Data & Settings - Dynamic System Behavior

NITRD.4 – Autonomous patient therapy

A key objective of the NITRD MDI workshop was to understand how to move toward autonomous care delivery technology, leveraging similar work in safety-critical industries such as avionics and transportation systems (including autonomous consumer passenger vehicles).

2435

Consider *Figure 53*:

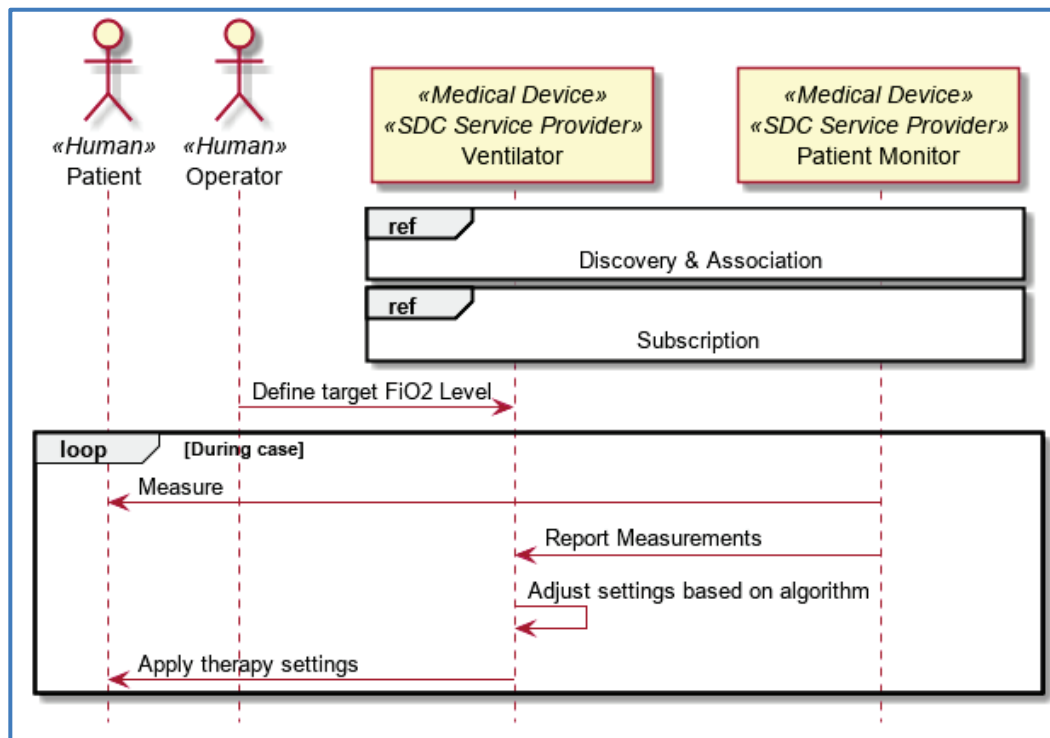

Figure 53 NITRD-4: Autonomous Patient Therapy - Dynamic System Behavior

2440 In this illustration, a ventilator supports an external control service for maintaining a target FiO₂ level; however, the ventilator does not have an integrated FiO₂ sensor and thus relies on receiving these measurements from a networked patient monitor. In addition to the inclusion of a closed-loop control (CLC) function in one SDC network participant, since MDPWS supports <safe and secure communication>, this device-to-device autonomous system-of-systems, is able to perform the intended function. See Section 8.7.3 *Medical Device Profile for Web Services (MDPWS)*, especially *Figure 28 MDPWS Extended Capabilities*, for more detail.

2445

10.1.1.2 Example: IHE PCD “Quiet Hospital” — Device to Clinician and Back-again

2450 The IHE PCD group launched an initiative in the spring of 2018 to address the well-known problems of “alert fatigue” in acute healthcare contexts where clinicians are almost constantly inundated by a myriad of alert indicators – visual and audible – and as a result inadvertently “tune out” the “noise”, resulting in significant patient safety and care quality problems. The Quiet Hospital approach is designed to reduce the amount of noise disturbance encountered in the typical medium and high-acuity hospital care unit.

2455 *Sam, a nurse in University Hospital’s high-acuity intensive care unit is continuously bombarded with alert sounds emanating from a variety of medical devices including infusion devices, ventilators, nurse call systems, patient monitors and/or associated central monitoring systems. This can result in alarm fatigue, especially since only a portion of these alerts are intended for her. In addition, Kelly – one of Sam’s patients,*

2460 *hears many of the same alarm sounds increasing his overall level of stress as well as interrupting his rest.*

2465 *The Quiet Hospital (QH) introduces the concept of “Alarm/Alert Delegation” which allows one medical device (usually SaMD) to act as an alarm proxy for other medical devices/sensors. For example, an SpO2 monitor, blood pressure monitor or infusion device on an SDC network can delegate its alarm signaling to a local patient monitor (on the same network). In turn, a ventilator and the patient monitor can delegate their alarm signaling to a central station. The central station (acting as a PCD AR or via an independent SDC device gateway acting as an AR) can, in turn, delegate the function of alarm signaling to an alert communications manager which sends alert notifications directly to Sam’s smart phone or another personal device. This can result in reducing or eliminating the noise level in the care unit as well as the potential for alarm fatigue. The reduced noise level also reduces Kelly’s level of stress and allows for uninterrupted periods of rest.*

2475 *Given the possibility of communication errors or system failures which could affect patient safety, appropriate feedback loops must be in place to mitigate any hazards that may result in dropped alerts or other malfunctions.*

Finally, in order to support longer term alert logging and analysis of alert patterns a separate SDC to FHIR gateway can be installed to capture the alert traffic and “serve” results to interested applications.

An additional scenario (not detailed here though) relates to isolation ICUs:

2480 *Claire is an ICU nurse and responsible for patients which have severe infectious disease and therefore, these patients are housed in isolation rooms in order to prevent the spread of diseases in the hospital. According to hospital’s protocol for isolation rooms, she has to wear protective clothing and is not allowed to use her mobile device in the isolation room. As Claire enters the isolation room, clinician location tracking automatically suspends the audio alarm delegation for all the bedside device in the isolation room, so that she will directly acoustically be notified by the device in the isolation room detecting an alarm event.*

2490 *Once she is done with her care, she leaves the isolation room, goes through the decontamination procedure, and the alarm delegation automatically disables the audio alarm at the bedside device again providing a quiet environment for the patient.*

A key point here is that alert delegation should be a core function of any MDI solution, out-of-the-box, and not require additional “glue” software and intermediary systems to support these safety critical functions.

Based on this narrative, derived component use cases include:

- 2495 SDC/QH.1 – Device alert signal delegation to single-pt. alert aggregator
 SDC/QH.2 – Single pt. alert aggregator alert signal delegation to multi-pt. aggregator
 SDC/QH.3 – Device alert signal delegation to Alert Manager

- 2500 SDC/QH.4 – Multi-pt. aggregator to Alert Communication Manager
- SDC/QH.5 – SDC to FHIR Gateway.
- SDC/QH.6 – Alert Manager to care-giver Alert Communicator
- SDC/QH.7 – Alert Communicator failure
- SDC/QH.8 – Alert Manager failure
- SDC/QH.9 – Multi-pt. aggregator failure
- SDC/QH.10 – Single pt. aggregator failure

2505 The following *Figure 54* provides a possible information flow model that would support the above narrative. Note: This is for illustrative purposes only and was created as one of numerous options that might be demonstrated at the HIMSS20 Interoperability Showcase.

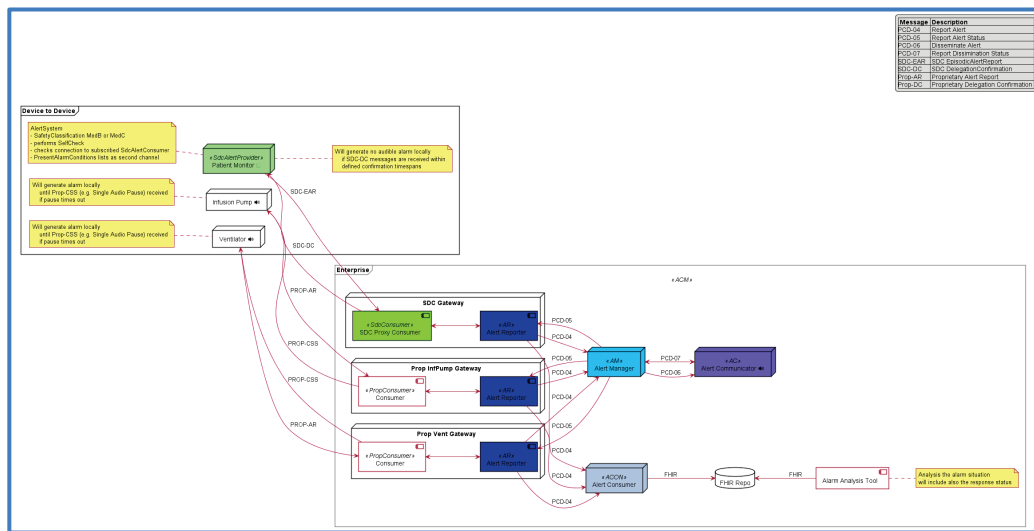

2510 *Figure 54 SDC "Quiet Hospital" Interaction Diagram*

2515 This interaction diagram illustrates how the device-to-device alerting provided by SDC can be coupled (via a gateway) to the enterprise-facing ACM Profile actors. Note that “from the device interface” flows in this diagram also show the status quo of today with proprietary communications to device-specific gateways, in this case infusion pumps and ventilators. In the case of the infusion pump, accommodation is also provided for supporting the SDC-standardized Episodic Alert Report (EAR) SOAP messaging. As stated previously, the regulatory challenges around patient-connected devices has historically resulted in the implementation of proprietary, non-interoperable communication protocols.

2520 In the case of SDC alerting devices, a “proxy” actor can be grouped with the ACM Alert Reporter (AR) Actor to provide integration with an ACM Alert Manager (AM) system, as well as an Alert Consumer (ACON) to archive device alerts. Since SDC supports alert delegation, the scenario above would then allow clinicians and edge systems to participate in “quiet hospital”

scenarios as described above and indicated by the SDC “delegation confirmation” (SDC-DC) signal back to the alerting device.

- 2525 A FHIR server “alert repository” is also included in the diagram – though its logical connection could be easily relocated – reflects the potential to leverage work underway in the Devices on FHIR working group to create a FHIR profile addition to the PoCD FHIR Implementation Guide that would then enable not only the use of FHIR for remote device alerting but also the archival of device alerting (e.g., content from PCD-04 to PCD-07, SDC-EAR and SDC-DC messages)
- 2530 that can be used for analytics, to improve patient safety, care quality and the environment of care.

A note on SDC “Alert Signal Delegation”

- 2535 We should note that the IHE PCD ACM Profile is focused on alert “dissemination” (secondary alert notification) and not alert “delegation” (primary alert notification). SDC, which is optimized for high-acuity medical device alerting – both annunciation and control – is designed for alert delegation which has a formal definition and functional specification within the IEEE 11073-10207 standard:

- 2540 **ALERT SIGNAL DELEGATION:** Capability of a POC MEDICAL DEVICE to let another PARTICIPANT generate a POC MEDICAL DEVICE’s ALERT SIGNAL as primary ALERT SIGNAL in order to indicate the presence of an ALERT CONDITION on the POC MEDICAL DEVICE. ⁷⁹

- 2545 Given that alert signals are medical device risk mitigation measures – one of a few strategies – the definitions and functionality associated with them represent a regulatory / legal liability responsibility assumed by the device and system vendor. The SDC alert signal delegation capability⁸⁰ provides for distributed alert systems as defined in the IEC 60601-1-8 standard. This includes the sharing or “contracting” of responsibility for the risk mitigation, whether that delegation recipient / SDC participant is at the point-of-care or in a remote location. As a result, the performance requirements for an SDC alert delegation function end-to-end must support more stringent real-time quality of service capabilities, attendant to the criticality of the risk being mitigated and the associated regulatory burden of proof.

- 2550 See Section 10.2.3 Profile: *SDPI-A* for Alerting for additional information.

10.1.1.3 Example: Preeclampsia During Pregnancy Across the Continuum of Care

- 2555 Although SDC is optimized for highly acute care contexts, such as an emergency C-section delivery room, the information generated and consumed by SDC-enabled devices should be semantically interoperable with other systems across the continuum of care. The Preeclampsia During Pregnancy (PDP) use case below illustrates the role SDC plays within this overall care coordination scenario.⁸¹

⁷⁹ Source: IEEE 11073-10207, section 3.1 Definitions.

⁸⁰ See IEEE 11073-10207, section 6. Alert signal delegation.

⁸¹ This PDP use case was originally developed as a

Storyline:

2560 *Holly, a pregnant mom, goes to the clinic for a regular check-up where hypertension + proteinuria are detected resulting in a diagnosis of preeclampsia. She is monitored for preeclampsia (hypertension) during the remainder of her pregnancy utilizing a personal health device (PHD) blood pressure monitor and urine analyzer. A Clinical Decision Support (CDS) system is integrated to help with the real-time monitoring of Holly's condition. During Holly's final pre-natal exam, it was determined that the infant was under stress and an emergency C-section was performed. After delivery (postnatal) everyone expected her blood pressure to return to normal within a few days or weeks; however, to ensure this is the case, as part of her discharge Holly is prescribed to continue her home monitoring regimen and the CDS system oversight is also continued.*

2565 *Shortly after her discharge, Holly's BP spikes which is detected by the CDS and the physician is alerted to action. It's a good thing that she was being actively monitored. The problems were quickly identified, her caregivers alerted, and she was re-admitted to hospital before the condition progressed to eclampsia and seizures.*

2570

As illustrated in the following diagram, the use case includes:

- In-hospital, at home and mobile / clinic care contexts
- Acute point-of-care care devices and personal health devices
- May also include lab including Point of Care devices and transactions
- Location tracking and Device Identification / Association Management
- A Cloud-based CDS system and “locally” networked systems & applications

2580

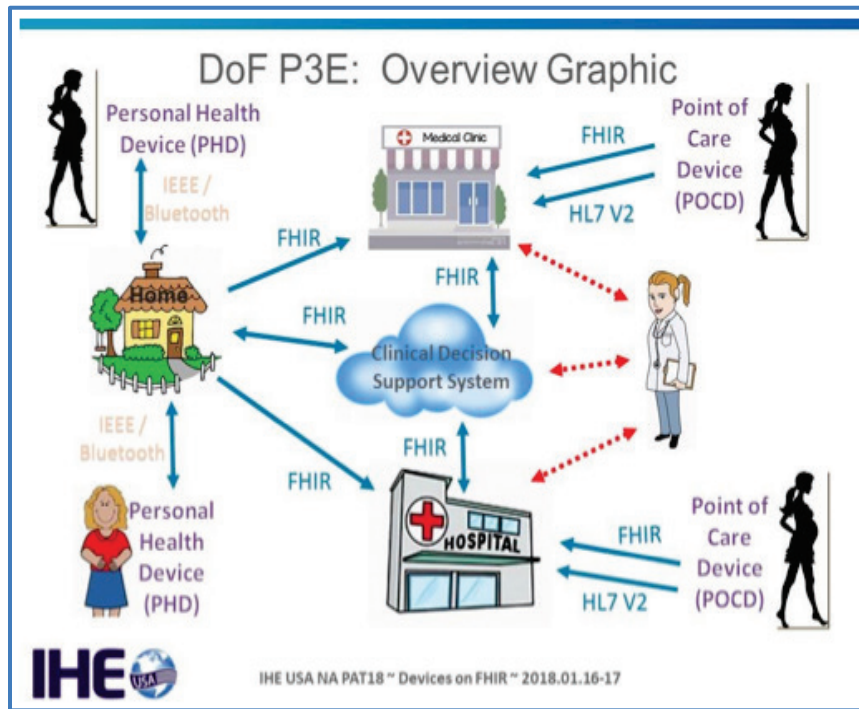

Figure 55 Preeclampsia During Pregnancy (PDP) Use Case⁸²

2585 Note that the device data flows include FHIR-enabled systems at home and at regional pregnancy clinics utilizing Continua PHDs, as well as acute care PoCD devices that leverage both FHIR and HL7 v2 (IHE PCD) information flows. The CDS System requires standardized semantics, as do machine learning and similar solutions.

2590 As mentioned above in *Example: IHE PCD “Quiet Hospital” — Device to Clinician and Back-again*, the Devices on FHIR workgroup is updating the PoCD FHIR Implementation Guide (IG) to include an alerting function, possibly defining an AdverseEvent FHIR resource tailored for the unique needs of acute care medical devices, especially quality of service and high-priority handling of critical device alerts. When considering the PDP use case, above, the infrastructural challenges increase significantly when using technology spanning hospital to home to clinic. Thus this use case drives consideration of the commonality of MDI functions across a broad I.T. landscape, and should also drive updating of the PHD FHIR IG as well. It should be noted that
 2595 IEEE 11073 PHD devices can be and often do fall under regulatory oversight, due to the potential safety risks. Given the increased acuity of patients being treated in their homes, this will continue to increase.

10.1.2 From DPI to SDC to: SDPi

“What’s in a name?”

⁸² Illustration by John Donnelly reporting out from the 2018 IHE North American Connectathon Devices on FHIR Plug-a-thon.

- 2600 One of the hardest start-up challenges is crafting the right name for something, be it a new organization, a project, or even an IHE profile. Historically, IHE PCD established a Device Point-of-care Interoperability (DPI) profiling initiative to address MDI “from the device interface” – since SDC addresses that same connectivity use context, should the “DPI” moniker be used? What about ICE or D2D, etc.?
- 2605 Also, should all SDC capabilities be bundled into a single profile leveraging a single name? Or should provision be made for additional “sub” profiles to be added in the future as the PCD specifications expand? Specifically, capabilities beyond basic discovery and association and reporting, to alerting, remote control, waveform streaming, etc. The specific profiling approach is detailed in next Section *10.1.3 Approach for Mapping SDC to IHE*; however, thinking through
- 2610 the preceding questions, the SDC@IHE project team settled on the following acronym for the IHE PCD SDC family of profiles:

Service-oriented Device Point-of-care Interoperability (SDPi)

Simply put, this is a mash-up between SDC and DPI.⁸³ Best of both ... old and new!

- 2615 It also integrates the service orientation technical approach, medical device focus, and high-acuity clinical focus. The “i” was proffered as a “Pi” nod to the geeks in the MDI community. Also, though most IHE profiles utilize three letter acronyms (e.g., DEC, PIX, MHD, etc.) there are many exceptions, including PIXm (FHIR enabled) or XDS.b or PCIM.

- 2620 This will also work well for labeling the related SDPi profiles that support reporting, alerting and controlling, along with options for each. Just as XDS-I is used for the “imaging” extension of the foundational XDS.b Profile, SDPi-A (alerting) could be used for additional IHE PCD profiles that build upon the foundational SDPi specification.

10.1.3 Approach for Mapping SDC to IHE

The approach for integrating SDC capabilities into a set of IHE PCD SDPi profiles can be summarized as follows:

- 2625 1. Multiple Profiles A base SDPi Profile with add-on profiles, rationale:
- ✓ Bundling all SDC capability into a single profile would prove overly complex, unwieldy and hard to maintain
 - ✓ Better supports mapping SDC capabilities to use cases + other profiles (see “Gateway Actors” below)
 - ✓ Other IHE profiles have addressed the complexity and evolution issues
- 2630

⁸³ It should be noted for history buffs that the “I” in the original DPI was for “integration”; however, given the modern movement toward focusing on Interoperability, the proposal was seen as resonating more with the broader community.

		✓ All additional profiles will be dependent on the SDPi Profile and group their actors with the appropriate SDPi actor
2635	2. Profile Options	Non-mandatory / conditional capabilities will be specified as options to the appropriate profile. For example, SDPi secure transmission, which is a foundational capability that may be leveraged by the other SDPi-x profiles. Options may be sourced from the SDC Core standards (per ICS tables in each standard) or from other IHE profiles (e.g., support for FHIR gateway).
2640		
	3. Profile Actors	Per <i>Figure 16</i> , SDPi will provide SDC ServiceProvider and ServiceConsumer Actors, as well as an SDCProxy Actor for SDC-external capabilities ⁸⁴ . Each of the additional profiles will provide profile-specific actors that are grouped with the core SDPi actors. For example, an SDPi-R Profile will define a ServiceReporter Actor that is grouped with the SDPi::ServiceProvider Actor.
2645		
	4. Profile Use Cases	These will be sourced from the primary examples presented in <i>10.1.1 Use Cases & Requirements</i> above, as well as those listed in <i>Appendix D – Compendium of Medical Device Oriented Use Cases</i> below. Note that the SDC standards and capabilities are all rooted in the SDC Use Cases section of the Appendix.
2650		
	5. Profile Transactions	High-level functions such as Discovery-Implicit / -Explicit, Get, Event Report, etc. shall be supported. See <i>Figure 25 SDC BICEPS Service Model</i> , as well as interaction examples in <i>8.7.5 SDC Discovery & Service-based Exchange Examples</i> .
2655		
	6. Profile Gateway Actors	Grouped actors will be defined in the appropriate SDPi Profile to enable specification of the interaction between SDC enabled systems and other protocols. For example, an SDPi-A:AlertConsumer (ServiceConsumer) Actor could be grouped with an SDPi:SDCProxy and an ACM:AR Actor to support IHE [PCD-04] and PCD-04 HL7v2-based transaction exchange to an SDC network. See also <i>Figure 17 & Figure 20</i> above.
2660		
	7. Profile: SDPi	Basic SDC capabilities, including discovery & association (DnA) ⁸⁴ , service subscription, Archival, Localization, etc. Options that apply generally across all other SDPi-x profiles. See SDPi Profile Actors above.
2665		
	8. Profile: SDPi-R	BICEPS Reporting capabilities & options.
2670	9. Profile: SDPi-A	BICEPS Alerting capabilities & options.

⁸⁴ As mentioned above, SDC and SDPi will implement a “distributed registry” architecture where an SDC Registry actor will not be required. See *8.7.5 SDC Discovery & Service-based Exchange Examples* for more detail.

10. Profile: SDPi-xC External (remote) Control capabilities & options.

2675 Note that it is expected that there will be some “bundling” of these SDPi profiles due to potential cross-profile dependencies, such as a device that supports alerting and includes an “external control” service to enable silencing of the audible alarm or distributed alert “delegation” capabilities. In these cases, a device may be required – conditionally – to support both -A and -xC if it these extended capabilities are to be implemented.

10.1.4 Safety & Security Considerations

2680 As reviewed in 9.7 *Safety Considerations & Risk Management Support* above, and other subclauses in Section 9, SDC supports a wide array of non-functional requirements as well as risk mitigation capabilities throughout the SDC Core standards. These will be extended when the additional *Key Purposes and device specialization modules* IEEE 11073 SDC 11073-107xx standards are completed (see *Figure 18*). A number of the example use cases above, as well as
2685 the ICE conceptual model mapping (see 8.5 *SDC from an ASTM/AAMI ICE Conceptual Model Perspective*) add safety related requirements such as a Data Logger.

Explicit recognition of these non-functional, safety and security-critical requirements will be included in the SDPi TF-1 specifications and mapped to specific profile elements. Examples include time synchronization, UDI support, PCIM for patient-device association management,
2690 safe (high integrity) communication, data logger for forensic analysis, etc.

10.1.5 IHE Domain Coordination

In addition to IHE PCD technical framework integration, SDC MDI relates to interoperability specifications in other IHE domains including Surgery, Pharmacy, Lab, Radiology, and I.T. Infrastructure. The *Surgery domain* has already indicated interest in participating in the SDPi
2695 profiles development and ensuring close integration with their IHE TF components. For each of these, collaborative development will be pursued as early as appropriate, and the technical approach will be as specified above in [Profile Gateway Actors](#), with the grouping of actors between each domain as needed to capture the logic for how they interact. See also Section C.8 *ITI Profile: XDS on FHIR – Mobile Access to Health Documents (MHD)* for an example of
2700 cross-profile actor grouping.

10.1.6 Integration with Devices on FHIR® Implementation Guidance

The integration of SDC-based systems and HL7 FHIR enabled systems has been discussed in numerous places throughout this document including, 9.9 *Considering Additional Integration Architectures – RESTful, DDS, ...*, or the *Example: IHE PCD “Quiet Hospital” — Device to
2705 Clinician and Back-again*, where a FHIR server was integrated allowing access by analytics and decision support applications. The Devices on FHIR (DoF) working group composed of experts from HL7, IHE and PCHAlliance (Continua), has created and continues to evolve two FHIR Implementation Guides, one for PoCD and one for PHD systems, that ensures consistent mapping from the core IEEE 11073 semantic standards (terminology / nomenclature and
2710 information model) to FHIR resources. Reporting has been the primary focus to date and they are

now moving on to device alerting using FHIR. See [Devices on FHIR resource references](#) in *Appendix B – Bibliography*.

The DoF team is actively working on updating the PoCD FHIR IG to include mapping from SDC. The following table is an example of the analysis:

2715

	IEEE 11073 SDC	HL7 FHIR
Web service realisation	SOAP	(typically) RESTful
Communication topology	end-to-end	(typically) centralised repositories
Dynamic discovery	WS-Discovery	not intended
Synchronous communication	request-response	request-response
Asynchronous notifications	WS-Eventing	yes
Semantic annotations	coded values	coded values
Remote control	built-in	not intended
Safety mechanisms	Medical DPWS: SafetyContext, DualChannel	not applicable
Data compression	optional (EXI)	optional (gzip for RESTful)
Data streaming	Medical DPWS: Streaming	not intended
PHR management	not intended	built-in
Data traceability	optional (distributed)	built-in (repository-based)

Figure 56 IEEE SDC to HL7 FHIR Comparison

2720

Currently, the PoCD DoF team is focused on integrating a normative SDC mapping into the FHIR IG as opposed to creating a different document or adding it elsewhere, such as in this IHE PCD TF specification. It should be pointed out that though RESTful is the “typical” FHIR architecture implemented today, it does call out a SOA architectural paradigm that is also being actively developed within HL7 and HSPC.

2725

Various of the SDPi profiles, especially -Reporting and -Alerting will support gateway actors with FHIR integration, including in conformance to the PoCD FHIR IG specifications. [Grouped gateway actors](#) will be defined both at the basic SDPi Profile level (as a gateway actor profile option), as well as further specialized as needed for reporting, alerting and even external control.

The remaining subsections below provide additional perspectives on how each of the IHE PCD Technical Framework volumes might be organized, as well as additional considerations specific to that volume, building upon the general profiling approach and considerations above.

2730

10.2 Volume 1: Interoperability Profiles

2735

The TF-1 acts as the core organizing point for all elements of a profile, providing the high-level overview, exemplary use cases, architectural approach, selected standards to be profiled, options, constraints, dependencies, etc. Given the breadth of SDC and the relative newness of the subject matter to the MDI community, it is recommended that an approach analogous to what ITI used for XDS.b be leveraged here as well, namely the inclusion of a general SDC Interoperability introduction and overview/framework at the beginning of the SDPi section that will then set the stage for the normal TF-1 profile section template. It is anticipated that much of the material for the TF-1 can be migrated from this white paper.

10.2.1 Profile: SDPi – Core SDC Capabilities

2740 The foundational Service-oriented Device Point-of-care Interoperability (SDPi) Profile specifies those capabilities that are necessary for all SDC-based interoperability, especially general capabilities that will be required for the extended SDPi “key purposes” profiles: reporting, alerting and controlling. Core capabilities in the SDPi Profile include:

- 2745 1. **SDC Participation:** from connection to a SOMDS network to plug-and-play service discovery of other participating systems and device-to-device communication
2. **Service Discovery & Association (DnA):** both implicit and explicit
3. **SDC Service Model:** As illustrated in *Figure 25* and Section 8.7 *Service Model: From abstract ICE to SOMDA to WS-**.
4. **Time Synchronization:** Dependent on ITI CT Profile and the use of NTP
- 2750 5. **Mandatory & Conditional Capabilities** for ServiceProviders & Consumers
 - ✓ Example of a conditional capability is the requirement to support the Description Event Service for modular dynamically composable systems.

2755 As well as others. The SDPi Profile needs to scale from a very simple device-to-device connection, to a complete OR-based SOMDS with dozens of devices and applications. This requirement will minimize what is mandatory or conditional in the base profile and what is specified as profile options. Optional SDPi capabilities might include:

1. **Gateway Support:** At the general level with an SDC Proxy Actor (bidirectional) and specific for those recognized interfaces that will be needed by multiple SDPi profiles, such as:
 - 2760 ✓ Devices on FHIR
 - ✓ HL7v2 (esp. ORU messaging that is used by all of the current IHE PCD profiles)
 - ✓ PCIM and MEM profiles since most of the equipment management information and functions will be addressed at the most general SDPi Profile level;
2. **Secure Transmission**
- 2765 3. **Waveform Streaming**
4. **Compression (including EXI, see MDPWS)**
5. **Localization Service Provisioning and Selection:** Service provider may allow language selection, downloading of language-specific strings, etc.)
- 2770 6. **Data Logging:** using the Archive service and possibly a “Syslog” gateway export function. See BICEPS 7.3.9 as well as related content in the draft 11073-10700 Key Purposes standard.
7. **UDI Support**

2775 Note that for an SDPi-PCIM gateway, the SDC Context Service could be used to report associations to a PCIM gateway, along with SDC query and event reporting services. Multiple methods may be used to manage device-patient associations, including (a) set by an external system; (b) manually entered at the device; (c) use of an AutoID technology at the PoC and with additional information queried from SOMDS and external systems; or (d) a “Workflow Context Provider” system could publish ADTesque information to the SDC network.

Note that the Patient Context is an optional feature for a ServiceProvider Actor.

2780 The following diagram provides an example of how two SDPi actors, ServiceProvider and ServiceConsumer, might use basic SDC exchanges to establish and configure an association (see Figure 60 for a legend of the transaction labels):

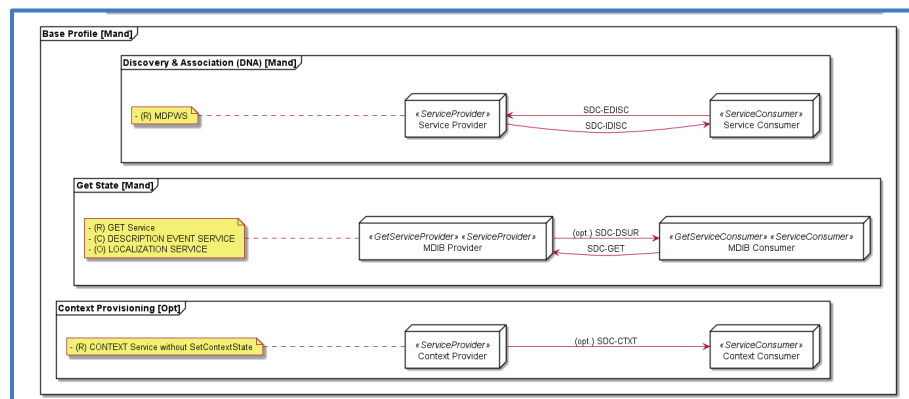

2785 *Figure 57 Example: SDPi General Capabilities*

The first DnA (mandatory) capability indicates both inherent (SDC-IDISC) and explicit (SDC-EDISC) discovery mechanisms, as discussed earlier. The second example is for a Get State (mandatory) capability, as well as a conditional (optional) Device Structure Update Report (SDC-DSUR) that is required for modular devices where components can be attached or removed. Finally, Context Provisioning (optional) is illustrated where a device’s context configuration is reported. See *Figure 1 BICEPS Medical Device System Contexts* for more information on SDC contexts.

2790 Note that in this example, each of the actors is given a different specialized name (e.g., MDIB Provider/Consumer or ContextProvider/Consumer). Though this is an allowable approach to take in IHE Profiles, typically the intent is to minimize the number of actors, bundling in mandatory behavior where needed and then adding optional behavior as appropriate. The final approach for the base SDPi Profile will be established during TF-1 development.

10.2.2 Profile: SDPi-R for Reporting

2800 The SDPi-R Profile will support the reporting key purposes (IEEE 11073-10701, draft) capabilities for an SOMDS. It will leverage all the capabilities as needed from the foundational SDPi Profile, and add support for:

1. Basic device-to-device information exchange
2. Periodic (optional) and episodic (mandatory) updates
- 2805 3. (optional) Archive Service to support data logger functions (capturing updates while off-line)
4. (optional) DEC Gateway, possibly with bidirectional reporting as well as filtering, leveraging all three DEC DOR, DOF and DOC actors (see *C.2 PCD Profile: Device to Enterprise Communication (DEC)*)
- 2810 5. (optional) IPEC Gateway mapping SDPi-R updates to generate IPEC [PCD-10] messaging.

The following graphic presents a number of example exchanges between actors in the SDPi-R Profile:

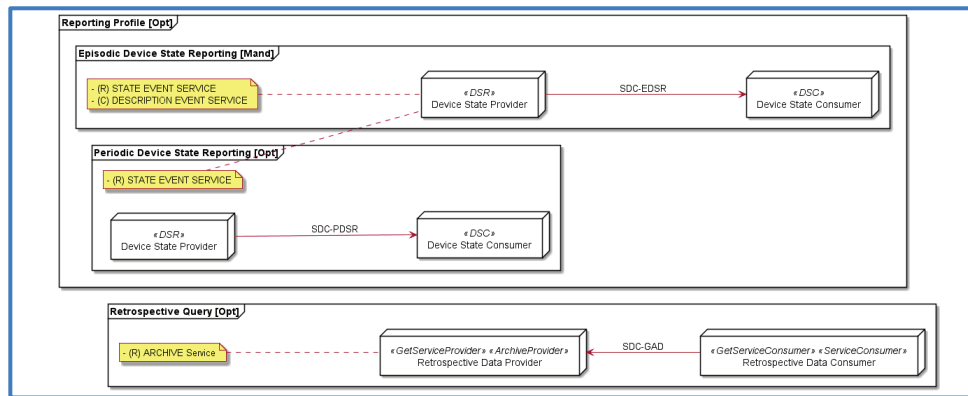

2815 *Figure 58 Example: SDPi Reporting*

Both the mandatory episodic device state report (SDC-EDSR) and optional periodic device state report (SDC-PDSR) are illustrated as well as an optional retrospective data query that uses the Archive Services. This could be used to support a PCD RDQ Profile gateway function.

10.2.3 Profile: SDPI-A for Alerting

2820 The SDPi-A Profile will support the alerting key purposes (IEEE 11073-10702, draft) capabilities for an SOMDS. It will leverage all the capabilities as needed from the foundational SDPi Profile, and add support for:

1. Comprehensive alerting support around the PoC, fully conformant to IEC 60601-1-8 requirements
- 2825 2. (optional) Alert delegation where a provider device could “contract” with a remote system to provide distributed alerting, enabling the device to minimize the noise and distraction at the PoC. Delegation could be to a centralized system at the PoC, or to remote systems.

3. (optional) ACM Gateway

2830 Examples of alert-based exchanges were presented above in *section Example: IHE PCD “Quiet Hospital” — Device to Clinician and Back-again.*

For additional IHE PCD ACM information, see *C.3 PCD Profile: Alert Communication Management (ACM).*

10.2.4 Profile: SDPI-xC for External Control

2835 The SDPi-xC Profile will support controlling key purposes (IEEE 11073-10703, draft) capabilities for a SOMDS. External device control in a plug-and-play architecture such as BICEPS and SOMDA has been a historic challenge. As discussed above, SDC provides not only the technical controls that allow for automation and autonomous systems, but also the risk management and regulatory non-functional requirements that are necessary to ensure safe, effective and secure operation of the entire SOMDS. SDPi-xC capabilities include:

1. Basic device-external (remote) control services (see BICEPS “remote control” capabilities, as illustrated in *Figure 23 SDC Medical Device Information Model*)
2. Safe data transmission (see MDPWS section 9. *Safe data transmission*) providing an added level of integrity and confidence
- 2845 3. (optional) PIV Gateway sending infusion programming information directly to the device.

The following figure provides examples of SDC-based control:

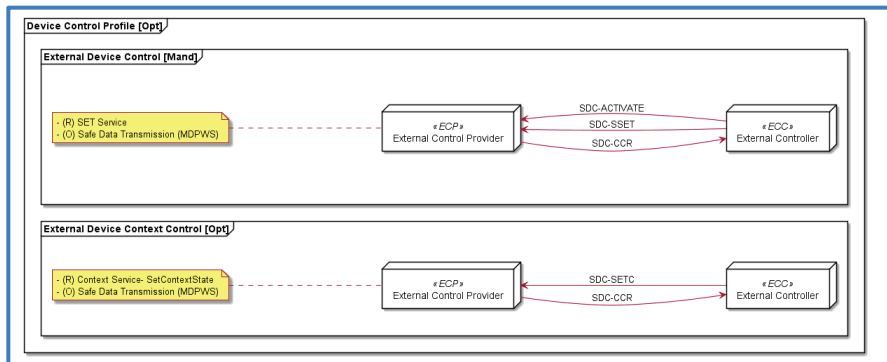

Figure 59 Example: SDPi External Control

2850

In the first example, a BICEPS Set service is used along with an established “safe data transmission” connection to activate and set a device control service, as well as listen for its Control Command Report response. For SDPi-xC this scenario is mandatory. An optional control would be for changing a device’s Context state / setting, still requiring use of the “safe data transmission” capability specified in MDPWS.

2855

A number of other external control examples are provided elsewhere in this document. Of particular interest, though, is the ability to achieve external control over distance. Some of the

2860 examples above provide for a central “smart” device at a PoC to integrate both reported information (including alerts) and controls for networked devices, all in a single user interface, or in a closed-loop clinical algorithm execution engine. Potential applications, though, include being able to add a gateway proxy that supports truly remote (distance) control of patient connected devices. SDPi-xC will initially focus on controlling functions for equipment and applications at the PoC; however, extension to enterprise and telemedicine applications will also be considered.

2865 **10.2.5 Future Profile: Device Specializations (DS)**

The SDC Module Specifications (11073-107xx) discussed above and illustrated in *Figure 18*, and the forward looking device specialization perspectives in *9.1.2 Approach for Device-specific Profiles*, paint a picture of how the existing and SDPi device-agnostic profiles might be combined in a new PCD TF-1 Device Specializations section that focuses on interoperability capabilities that support specific device and SOMDS clinical / medical operations.

Though specific proposals are beyond the scope of this white paper, given the speed with which these standards are evolving and being implemented, it is anticipated that that “future” is not too far distant.

10.3 Volume 2: Technical Transactions

2875 The primary technical specifications for achieving information exchange between systems is contained in Volume 2. This is achieved by specifying the technical detail required to achieve the actor-to-actor interactions / transactions in Volume 1. In the case of the SDC standards, this will *primarily* focus on content that is in the IEEE 11073-20701 SOMDA standard and the IEEE 11073-20702 MDPWS standard, which provide the WS-* implementation technology bindings to the requirements in the IEEE 11073-10207 BICEPS standard.

At this point, a proposed set of transactions is not necessary, especially given the SDC and SDPi information detailed above. These transactions will fall out of the next phase of SDPi profiling, namely drafting the TF-1 profile content. Another example of potential transaction “information flows” are identified in the table below (copied from the examples above):

2885

Message	Description
SDC-IDISC	SDC Implicit Discovery
SDC-EDISC	SDC Explicit Discovery
SDC-EDSR	SDC Episodic Device State Report
SDC-PDSR	SDC Periodic Device State Report
SDC-GDS	SDC Get Device State
SDC-DSUR	SDC Device Structure Update Report
SDC-CC	SDC Device Control Command
SDC-CCR	SDC Device Control Command Report

Figure 60 SDC Example Information Flow Labels

Note that during the profiling process for TF-1, design questions will be addressed, such as:

- ✓ Single Discover Service transaction or separate -Implicit / -Explicit transactions
- 2890 ✓ Is -Explicit contained in a separate high-level SOMDA-Connect transaction?
- ✓ Do some operations such as Device Control Command and Report get combined into a single transaction or are they separated as above, and if so, why?

2895 These and many other questions will be addressed in the next phase of SDPi profiling activity. Also the content in TF-2 Transactions is intended to provide the necessary bindings to the detailed specifications in the SDC Core standards, but not to duplicate that standard content! There may also be additional constraints specified for the use of a particular SDC capability in an SDPi Profile, narrowing or even eliminating the options that are present in the underlying standardization. This is typically a good thing to advance ... interoperability.

2900 Consideration should be given, though, to analyzing the potential list of transactions that will be needed for the basic set of SDPi profiles and then as has been done with other TF's (e.g., ITI) allocate sufficient transaction numbers to allow for co-location in the technical framework.

Finally, see *Appendix E – SDC Message Examples* for detailed examples of the kinds of transactions that will be supported by the SDPi transaction specifications in the IHE PCD TF-2 document.

2905 **10.4 Volume 3: Semantic Content Modules**

2910 The topic of semantic content specification was covered in detail above, including in sections 8.6 *Semantic Model: From Nomenclature to Information Models*, 7.4.2 *Proposed NIST Framework Integrating SDPi Support*, and 9.1 *General Connectivity to Device Specializations*. Since IEEE 11073 SDC is built upon the same semantic constructs as are used throughout the IHE PCD TF, as well as in the Devices on FHIR, IEEE PHD and even MDPnP/OpenICE specifications, ensuring semantic interoperability is a relatively straightforward effort.

2915 It is anticipated that for the proposed initial set of SDPi profiles, no updates to the IHE PCD TF-3 will be required. The needed bindings will be called out in TF-1 at the profile level and TF-2 at the transaction level, as appropriate. When device specialization modules and profiles are added to the technical framework, updates will be proposed for TF-3, both in terms of new types of equipment that is not currently identified in that volume, as well as value sets that might be bound to specific transactions used for device specific interactions.

11.0 Roadmap & Timeline

2920 The purpose of this white paper is to paint a picture of how IEEE 11073 SDC-based interoperability could be integrated in to the IHE PCD technical framework. Clearly, though, this is a significant, sometimes complex, endeavor that will take a number of years to accomplish. Any such journey of significance has a map with a “Start Here” marker, along with milestones, way markers, notional time lines, etc. This final section provides guidance on how to proceed

2925 It should also be noted that any such roadmap and timeline is out-of-date the second the first step is taken (or not!) and real-world challenges come in to play. As a result, this proposal should be considered with that in mind and updated periodically per the established IHE PCD planning committee program review activities.

2930 Finally, though the IHE process has proven effective for realizing interoperable products that are ready for implementation and use in healthcare, the 18-month starting point for new profile development is a non-starter for many of today’s product cycles. This is especially true when the underlying technologies have approved standards and are implemented in products that are on the market. Therefore, the 3-year roadmap below recognizes the timeline associated with international CAT and demonstration events; however, aspires to shorten significantly the IHE profile specification and testing cycles, as well as adding plug-a-thon (PAT) and hack-a-thon events to ring out the specifications as well as build the SDPi implementation community.

2940 The SDPi roadmap is organized so as to maintain general adherence to the overall IHE process as illustrated in *Figure 3 IHE Process: Connecting Healthcare Technology Stakeholders*, but recognizing the need to accelerate the specification, prototyping and testing phases in accordance with the maturity of the underlying standards and specifications, as well as available tooling, while balancing with the resources available to advance the program.

Consider the following *strawman proposal*, along with the following “[Considerations](#)”:

SDPi Year 1 (2019 – 2020)

- **SDPi White Paper**
 - 2945 ○ Preparation 06/2019 – 07/2019
 - Pubic Review 08/2019 – 09/2019
 - Publish 10/2019
- **SDPi SDC and SDPi-R TF**
 - 2950 ○ Preparation 09/2019 – 10/2019
 - Public Review 11/2019 – 12/2019
 - Publish 12/2019
- **IHE Connectathons ’20**
 - North America 01/2020 PAT at minimum; CAT aspired!

- 2955
 - Europe 04/2020 CAT (w/ well established SDC community)
 - Australia 07/2020 (tbd)
 - Korea 08/2020 (tbd)
 - Japan 10/2020 (tbd)

- **Other Testing Events**

- 2960
 - X73@HL7 WGM 9/2019(Atlanta), 2/2020(Sydney), 5/2020 (San Antonio)
 - <Europe? OR.net?>
 - <Virtual? Special?>

- **Public Demonstrations**

- 2965
 - HIMSS20 03/2020
 - <others? Europe, AAMI, RSNA, AsiaPac, ...>

SDPi Year 2 (2020 – 2021)

- **SDPi-A TF**

- 2970
 - Preparation 4/2020 – 6/2020
 - Public Review 6/2020 – 7/2020
 - Publish 8/2020

- **IHE Connectathons '21**

- 2975
 - North America 01/2021
 - Europe 04/2021
 - Australia 07/2021 (tbd)
 - Korea 08/2021 (tbd)
 - Japan 10/2021 (tbd)

- **Other Testing Events**

- 2980
 - X73@HL7 WGM 9/2020(Baltimore), 1/2021(Salt Lake City), 5/2021(New Orleans), 9/2021(TBD)
 - <Europe? OR.net?>
 - <Virtual? Special?>

- **Public Demonstrations**

- HIMSS20 03/2021

- <others? Europe, AAMI, RSNA, AsiaPac, ...>

2985

SDPi Year 3 (2021 – 2022)

- ***SDPi-xC TF***
 - Preparation 4/2021 – 6/2021
 - Public Review 6/2021 – 7/2021

2990

- Publish 8/2021

- ***IHE Connectathons '22***

- North America 01/2022
- Europe 04/2022
- Australia 07/2022 (td)
- Korea 08/2022 (td)
- Japan 10/2022 (td)

2995

- ***Public Demonstrations***

- HIMSS20 03/2022

- <others? Europe, AAMI, RSNA, AsiaPac, ...>

3000

Additional Roadmap Considerations ...

1. Not included are the aspects associated with the in-process IEEE SDC standards for “key purposes” and device “module” specifications, namely 11073-107xx. These can be integrated as they are completed over the next 18 months.
2. Gateway Actor development may need to be called out explicitly and accelerated, especially in the area of FHIR interoperation.
3. Not included are profile “options” that may be layered in after the primary profile is developed. For example, SDPi waveform streaming option. Another approach would be to collapse the core SDPi + -R -A -xC profile development into a parallel activities, and then add capabilities and options to each over time. More of an ***agile IHE profile development process***. This would be helpful when adding overall SOMDS capabilities that involve coordination / dependencies between multiple profiles.
4. Tool development relating to CAT testing + implementation support should be added.
5. Virtual or special out-of-cycle CAT events could also be scheduled to accelerate the schedule.

3015

6. IHE CA including certification is under evaluation and may be integrated to the roadmap when appropriate. Intent is to achieve certification-ability by close 2020, including 2+ successful CAT events, Final Text on SDPi at a minimum, and the necessary tooling.
7. Use of Product Registry and vendor SDoC⁸⁵ should be supportable by end of 2020.
- 3020 8. IHE SDPi demonstration events only include those that currently include IHE PCD connectivity demonstrations; SDC may well bring additional community members to both contribute as well as demonstrate SDPi interoperable solutions.
9. A maturity model dimension could also be added, per Section 9.8 above; however, this is deferred to a later planning exercise.
- 3025 10. ...

⁸⁵ SDoC = Self Declaration of Conformity; vendors who have passed CAT testing could publish SDoC statements, including in the IHE Product Registry, indicating their support for SDPi profile capabilities.

Appendices

Appendix A – Glossary

3030 <Reviewer: See [acronyms](#) above in Section 4.3. Many definitions are provided throughout the document. Please identify what is of general interest and should be included in either a Terms and Definitions section of this white paper, or also included in the IHE Glossary.>

The complete IHE Glossary is available [here](#).

Term	Definition
SDC	Service-oriented Device Connectivity

3035

Appendix B – Bibliography

3040 Since this white paper is not a “standard” there are no formal normative references; however, there is an increasingly large body of papers and presentations and other materials related to SDC. The items below provide a good starting point for digging deeper into SDC, from general overviews to research papers to implementation tools.

General Background Information

- 3045 1. **SDC@IHE wiki home** @ <https://wiki.ihe.net/index.php/SDC@IHE>
2. **SDC General Presentations & Articles**
- a. [IEEE SDC Overview \(by David Gregorczyk\)](#)
 - b. [SDC Wikipedia Article](#) (+ [German Version](#))
 - c. [SDC Standardization Update @ IEEE/HL7 2019-May \(Montreal\)](#)
 - 3050 d. “*An architecture for distributed systems of medical devices in high-acuity environments-A Proposal for Standards Adoption*”; Schlichting, S., & Pöhlson, S.; HL7, 2014. 11073/HL7 Standards Week.
3. **IHE General Background Information**
- a. IHE international Portal @ <https://www.ihe.net/>
 - 3055 b. IHE [Europe](#) & [USA](#) sites provide additional “deployment” information
 - c. NOTE: Webinars and other educational materials available at all the above web sites.
4. **ISO Technical Reports covering IHE standardization**
- a. ISO/TR 28380-1:2014 *Health informatics -- IHE global standards adoption -- Part 1: Process*
 - 3060 b. ISO/TR 28380-2:2014 *Health informatics -- IHE global standards adoption -- Part 2: Integration and content profiles*
 - c. ISO/TR 28380-3:2014 *Health informatics -- IHE global standards adoption -- Part 3: Deployment*

3065

Standards & Specifications

1. **SDC Standards**
- a. IEEE 11073-10207:2017 *IEEE Health informatics--Point-of-care medical device communication Part 10207: Domain Information and Service Model for Service-Oriented Point-of-Care Medical Device Communication* ([IEEE Store](#))
 - 3070 b. IEEE 11073-20701:2018 *Health informatics--Point-of-care medical device communication - Part 20701: Service-Oriented Medical Device Exchange Architecture and Protocol Binding* ([IEEE Store](#))
 - c. IEEE 11073-20702:2016 *Health informatics--Point-of-care medical device communication Part 20702: Medical Devices Communication Profile for Web Services* ([IEEE Store](#))
 - 3075

- d. Active IEEE Project descriptions (see *Figure 18 IEEE 11073 SDC Family of Standards (“Cathedral Window”)*) can be viewed at: <https://standards.ieee.org> (search for the project number, e.g., “11073-10701”)

3080

2. IEEE 11073 Related Standards

- a. IEEE 11073-10101:2004 *ISO/IEEE Health informatics -- Point-of-care medical device communication -- Part 10101: Nomenclature* ([IEEE Store](#))
 - i. NOTE: See also associated 11073-10101 and -1010x documents
- b. IEEE 11073-10201:2004 *ISO/IEEE International Standard for Health Informatics - Point-of-care medical device communication - Part 10201: Domain information model* ([IEEE Store](#))

3085

3. Other referenced standards

- a. ASTM F2761 [*Medical Devices and Medical Systems - Essential safety requirements for equipment comprising the patient-centric integrated clinical environment \(ICE\) - Part 1: General requirements and conceptual model*](#)
 - i. NOTE: The ASTM F2761 standard is now transferred to AAMI and published as: AAMI 2700-1:2019, *Medical Devices and Medical Systems—Essential safety requirements for equipment comprising the patient-centric integrated clinical environment (ICE) — Part 1: General requirements and conceptual model*
- b. See normative references and bibliography sections in the IEEE 11073 standards referenced above.

3090

3095

4. [IHE Technical Framework Specifications \(open/free\)](#)

5. Devices on FHIR (DoF)

- a. [Confluence Home](#)
- b. [Published PoCD IG](#)
- c. FHIR DevDays™/Boston 2018 – DoF presentation ([YouTube!](#))

3100

SDC & Related Implementation Resources

3105

- 1. [OR.net SDC Project](#)
- 2. [OpenSDC @ SourceForge](#)
- 3. [SDClib “surgitaix” C++ open source \(github\)](#)
- 4. [NIST Rosetta Terminology Mapping Management Tool \(RTMMS\)](#)

3110

SDC-Related Topics-in-Depth

1. SDC Conformance Principles (SDCCP)

- a. [SDC Conformance Principles @ IEEE/HL7 2019-May \(Montreal\)](#)
- b. [SDC Conformance Principles Document \(PDF\)](#)
- c. [OR.NET e.V., SDC Conformance Principles, D02, Jan. 2019 \(PDF\)](#)

3115

2. Alternative SOMDA Implementation: SDC over DDS

- a. “*Using Data Distribution Service for IEEE 11073-10207 Medical Device Communication*”, Merle Baake, University of Lübeck, July 18, 2018.

3. Risk Management –

a. Health Software to (regulated) Medical Software

3120

- [*FDASIA Health IT Report - Proposed Strategy and Recommendations for a Risk-Based Framework*](#)
- NOTE: This 2014 report provides a perspective on general HIT to clinical to medical software, along with examples of risk scenarios that are relevant to the proposed SDPi interoperability.

3125

b. ISO/IEC 80001 Risk Management Series, including

- IEC 80001-1:2010 *Application of risk management for IT-networks incorporating medical devices -- Part 1: Roles, responsibilities and activities*
- ISO/IEC 80001-2-x series on the application of 80001-1 to distributed alerting, security, wireless connectivity, etc.

3130

4. SDC Integration with ...

a. HL7 FHIR: “*IEEE 11073 SDC and HL7 FHIR – Emerging Standards for Interoperability of Medical Systems*”, Kasparick, Martin, et al.

b. ASTM/AAMI ICE: “*Point-of-care medical devices and systems interoperability: A mapping of ICE and FHIR*” (@

3135

<https://ieeexplore.ieee.org/abstract/document/7785165>)

3140

3145 **Appendix C – IHE Enterprise Facing Connectivity Profiles**

SDC-based interoperability is being added into a well-established and widely implemented set of point-of-care device profiles. As pointed out above, though, these are enterprise facing integration specifications that do not generally get implemented in the device’s communications interface. To facilitate the readability of this document and its detailed content, general elements of the referenced IHE profiles are provided in this appendix. The information is limited to what is necessary to provide clarity to the discussions herein, with pointers to where the more comprehensive detail can be reviewed.

IHE PCD profiles detailed below include:

- 3155 [DEC Device-to-Enterprise Communication](#)
- [WCM Waveform Content Management \(DEC option\)](#)
- [ACM Alert Communication Management](#)
- [IPEC Infusion Pump Event Communication](#)
- [PCIM Point-of-Care Identity Management](#)
- [PIV Point-of-care Infusion Verification](#)

3160 An IHE PCD technical framework component that is not strictly a “profile” is

[RTM Rosetta Terminology Mapping](#)

Additional IHE profiles include:

[XDS on FHIR](#) An example of how HL7 FHIR and IHE XDS.b are combined into a single architectural solution.

3165

All IHE profile technical framework specifications are publicly available at:

www.ihe.net/resources/technical_frameworks/

including those with content contained in this appendix.

3170 There are additional IHE PCD profiles that are not currently included in this appendix but may be added in a future edition if needed. These include:

1. IDCO: Implantable Device – Cardiac – Observation
2. MEM: Medical Equipment Management, including
 - ✓ MEM-DMC: Device Management Communication
 - ✓ MEM-LS: Location Services
3. POI: Pulse Oximetry Integration
4. RDQ: Retrospective Data Query

3175

C.1 IHE Technical Framework Elements

3180 The UML model in Figure 61 presents the primary elements of an IHE technical framework, which may facilitate understanding. Note that this is not an official IHE approved model nor is it guaranteed to be “golden truth”; however, it does provide general clarity of how the various parts of IHE TF specifications between the three volumes relate.

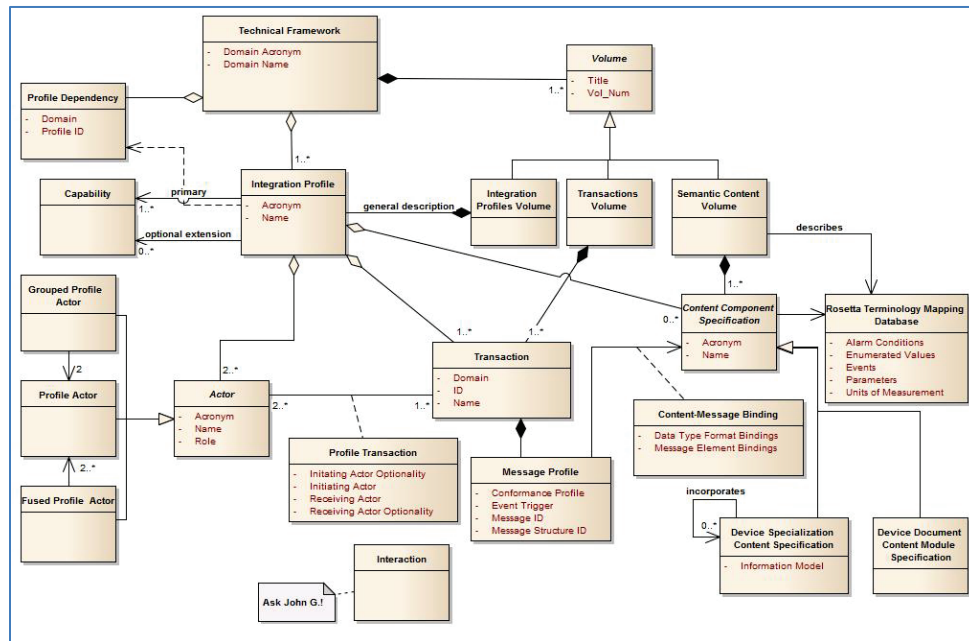

3185

Figure 61 IHE Technical Framework – Elements Model

Additional IHE technical framework overview information is available on the IHE wiki (see <https://wiki.ihe.net/index.php/Frameworks>, for example), and on the www.IHE.net website.

C.2 PCD Profile: Device to Enterprise Communication (DEC)

3190 The first integration profile that the IHE PCD group developed, and arguably the core specification to all that followed, was Device to Enterprise Communication (DEC). This was the starting point for the group’s work since many of the participating vendors already had HL7 v2 interfaces implemented for reporting device acquired data, making it a relatively easy path forward to standardize, prototype and implement in products. Also, most hospital enterprise systems utilize HL7 v2 messaging as the foundation for IT system connectivity, making deployment in clinical contexts relatively easy.

3195

The general approach of using HL7 v2 messaging to communicate IEEE 11073 semantic content (both terminology and information models) is the primary technical vehicle for the subsequently developed profiles for alert communication, infusion pump eventing, etc.

3200 Note: This profile was also used by the Continua Health Alliance for their WAN interface specification, albeit over the ITI's WS-* infrastructure.

C.2.1 General Device Data Reporting

Overview:

- TF Reference:** IHE PCD Technical Framework (TF-1 & -2)
- 3205 **Status:** Final Text / Wide Production Implementation
- Use Case Scope:**
- DEC.1 - Communicate patient identified DEC data to EMR/EHR
 - DEC.2 - Communicate validated periodic DEC data to EMR/EHR
 - DEC.3 - Use Cases for Automatic Patient Demographics Acquisition
 - 3210 DEC3.1 - Patient ID known in ADT, locally available
 - DEC3.2 - Patient ID known in ADT, not locally available
 - DEC3.3 - Patient ID not known in ADT, locally available
 - DEC3.4 - Patient ID not known in ADT, not locally available
 - DEC3.5 Other Clinical Examples
 - 3215 DEC3.5a – Association of Patient ID and Medical Device – via ID List
 - DEC3.5b - Association of Patient ID and Medical Device – via patient wristband
 - DEC3.5c - Association of Patient ID and Medical Device – via RFID tags
- 3220 **SDPi Use:** Reporting profile describes a grouped gateway actor with DEC:DOR; for bidirectional communication, a grouped DEC:DOC Actor could also be defined to receive data exchanged in the enterprise and provide that back to SDPi connected systems.

3225 The following simple actor diagram identifies the two actor/role pairs and the single transaction that is used to communicate device sourced data from a reporter system to the consumer.

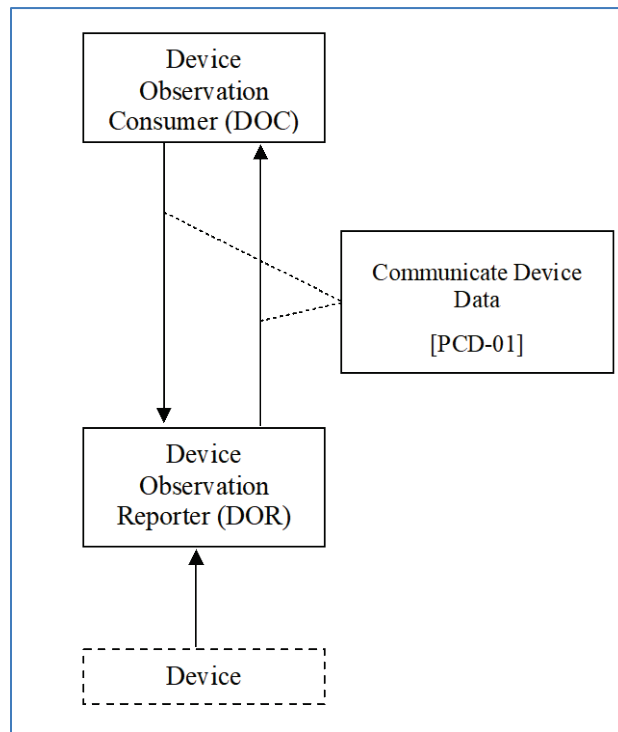

Figure 62 IHE PCD DEC Actor Diagram

3230 The message from the reporter to a consumer utilizes an HL7 v2 ORU^R01 message, constrained for device data reporting, and containing abstract IEEE 11073 semantic content (IHE PCD TF-3) mapped to specific HL7 v2 segment fields. Details on this message profile and the mappings are provided in the IHE PCD TF-2 Transactions specification. Note that though the diagram indicates bidirectional information exchange between the two actors, the device data being reported only flows from the DOR to the DOC.

3235 As indicated by the following DEC Profile options table, the HL7 MLLP (Minimum Lower Layer Protocol) transport is used by default. This is the primary v2 messaging transport protocol utilized across various infrastructures. Optionally, though, a WS-* option can be utilized as well. This option is in consistent use by the Continua implementation community as well as other IHE deployment committees such as IHE Korea.

3240

Actor	Option Name	Section in Volume 2
Device Observation Reporter	<i>No option (assumes MLLP Transport)</i>	Appendix I
	<i>Web Services (WS*) Transport Option (rather than default MLLP Transport)</i>	Appendix J
Device Observation Consumer	<i>None (assumes MLLP Transport)</i>	Appendix I
	<i>Web Services (WS*) Transport Option (rather than default MLLP Transport)</i>	Appendix J

Figure 63 IHE DEC Profile Options Table

3245 It should be noted that this WS-* Profile is aligned with what is published in the IHE ITI TF-2x Appendix V, as described in IHE PCD TF-2 Appendix J. This IHE ITI WS-* Profile is in no way aligned with the SDC WS-* Profile as specified in IEEE 11073-20702 MDPWS. See section Medical Device Profile for Web Services (MDPWS) above for additional information on the latter.

C.2.2 DEC Waveform Content Module (WCM)

Overview:

3250 **TF Reference:** IHE PCD WCM Supplement, TF-1 option for DEC, ACM; TF-3 defines the format for the actual waveform content (see below)

Status: Trial Implementation / Tested at numerous IHE connectathon events / some limited commercial use

Use Case Scope:

- 3255 WCM.1 - Alarm Waveform Snapshot
- WCM.2 - Real-Time Waveform Viewing
- WCM.3 - Archived Waveform Viewing
- WCM.4 - Mixed Snapshot and Continuous Waveform Viewing
- WCM.5 - Waveform Snapshot to EHR
- 3260 WCM.6 12 - Lead ECG

Supports both bounded (i.e., snippet) and continuous waveforms

3265 **SDPi Use:** Waveform streaming option for SDPi could include a grouping to a WCM option for IHE PCD DEC or ACM interfaces; this would be integral to / option for the -Reporting and -Alerting profiles that include a waveform support option.

As indicated above, WCM is mostly a content specification, leveraging IEEE 11073 semantics. The following figure provides an information model of the waveform content organization.

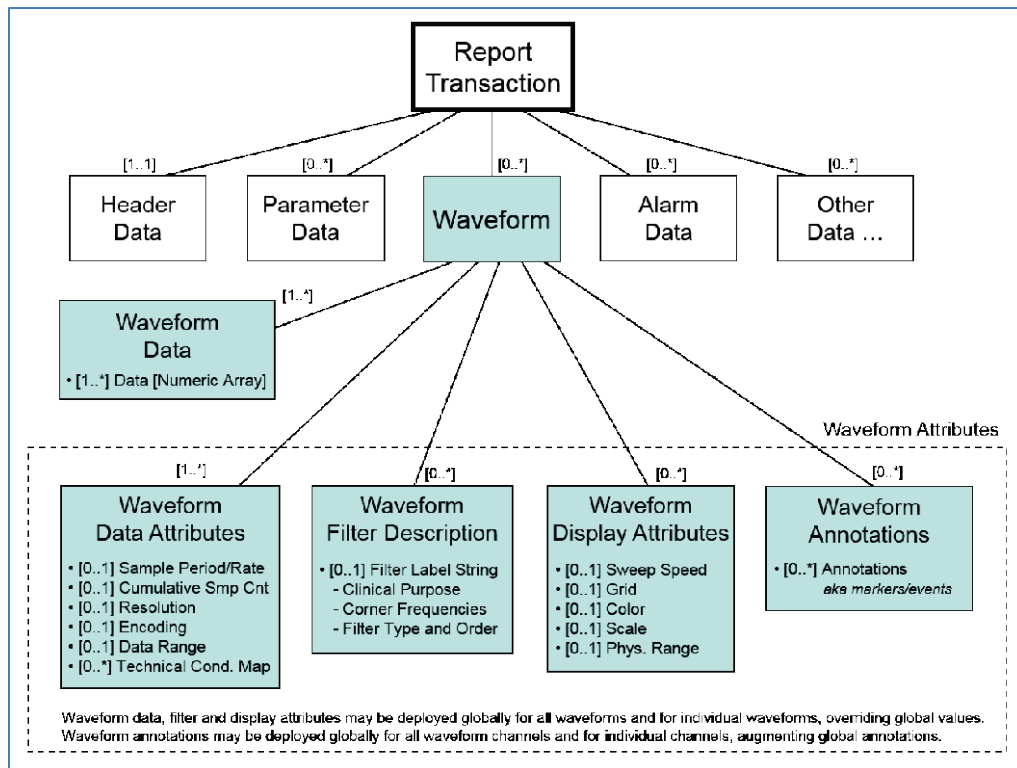

3270

Figure 64 IHE PCD Waveform Content Module (WCM) Model

It should be noted that this differs from the waveform specification contained in the HL7 v2 standard; however, by aligning the representation with the IEEE 11073 semantics, the robust data provided by these point-of-care devices can be represented more accurately with higher granularity.

3275

C.2.3 DEC Observation Filter – Subscribe to Patient Data

Overview:

TF Reference: IHE PCD SPD Supplement, defines a TF-1 DEC option and a TF02 SPD transaction message

3280

Status: Trial Implementation / Tested at numerous IHE connectathon events / no significant commercial use

Use Case Scope:

- SPD.1: Communicate patient identified data to EMR/EHR
- SPD.2 - Communicate validated periodic data to EMR/EHR
- SPD.3 - Subscribe to patient data at specific periodic interval
- SPD.4 - Subscribe to patient data for specific patients
- SPD.5 - Subscribe to patient data for patients from a specific location

3285

SPD.6 - Subscribe to patient data for a specific device or class of devices

SPD.7 - Subscribe to patient data for specific parameters or class of parameters

3290

SPD.8 - Request a snapshot of current or most recent patient data

SDPi Use: Could be used by -Reporting profile to “filter” the information received from a DEC grouped actor and provided to the SDPi connected systems

3295

The Subscribe to Patient Data (SPD) Profile was originally part of the DEC Profile; however, industry need was never sufficient to successfully test the capability at an IHE Connectathon⁸⁶, and thus when the DEC Profile went to final text, the SPD capability was pulled out into this profile supplement. It should be noted that though in concept, constraining DEC data feeds to only that content that was of particular interest to end systems would lead to overall system efficiencies, real-world systems would rather have the overhead of comprehensive “fire hose” device data and perform any filtering internally.

3300

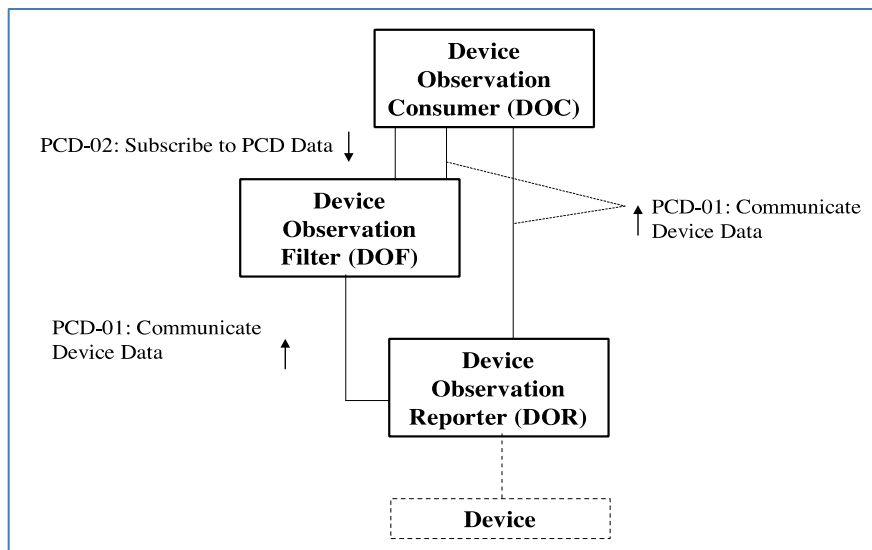

Figure 65 IHE PCD DEC SPD Option Actor Model

3305

Note the similarity between the SPD model above and the basic DEC model presented in *Figure 62 IHE PCD DEC Actor Diagram*. The supplement profile simply defines a PCD-02 transaction that allows a DOC to specify what information from which classes of devices it wishes to receive. The [PCD-01] that is sent from the DOF Actor will be filtered accordingly.

⁸⁶ “Successful” IHE Connectathon interoperability tests require three different actor/role pairings. So though the SPD capabilities were tested, there were never a sufficient number of participants to attain ... success.

3310 Finally, it should be noted that the Devices on FHIR (DoF) specification provides a subscription service that replicates what is available in SPD and is in much broader use today. Future gateway implementations may very well rely on the HL7 FHIR subscription service to pull data back into an SDPi environment rather than utilize a grouped DEC:DOF Actor.⁸⁷

C.3 PCD Profile: Alert Communication Management (ACM)

Overview:

3315 **TF Reference:** IHE PCD ...

Status: Trial Implementation / Tested at ... / <implementations?>

Use Case Scope:

 ACM.1 - Location Sourced

 ACM.2 - Identified Patient Source

 ACM.3 - Same as ACM.1/ACM.2 with Escalation with Cancel at Alert Source

3320 ACM.4 - Same as ACM.1/ACM.2 with Escalation with Cancel at Communication Endpoint

 ACM.5 - Same as ACM.1/ACM.2 with Escalation with Cancel at AM

 ACM.6 - Information with no destination other than logging by the AM

 ACM.7 - Equipment Sourced Alert

3325 **SDPi Use:** Gateway option for the SDPi-A Profile

⁸⁷ Confusion abounds: DOF = Device Observation Filter, DoF = Devices on FHIR initiative.

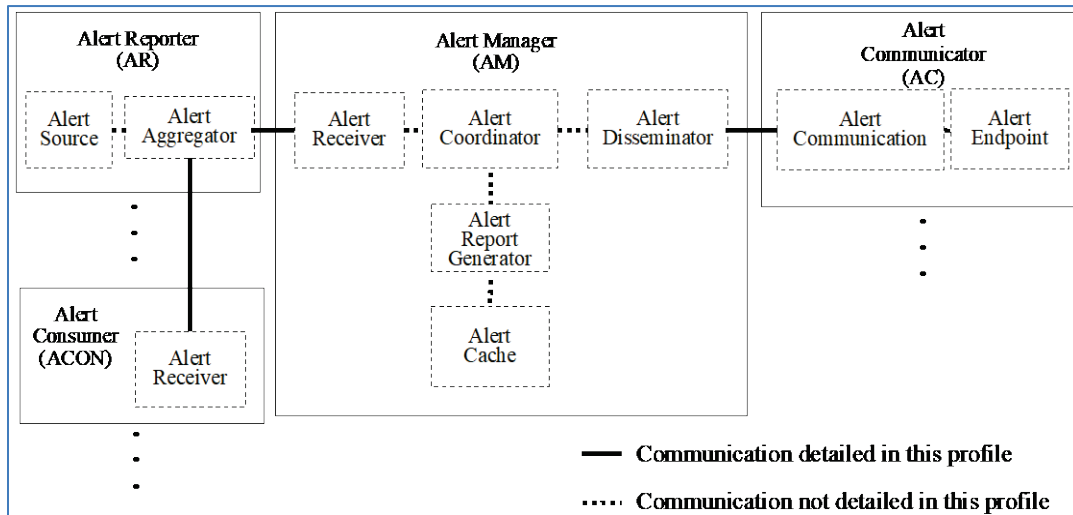

Figure 66 IHE PCD ACM Profile Actor Diagram (internal perspective)

3330 And a second rendering of the diagram calling out the transactions integrating each actor:

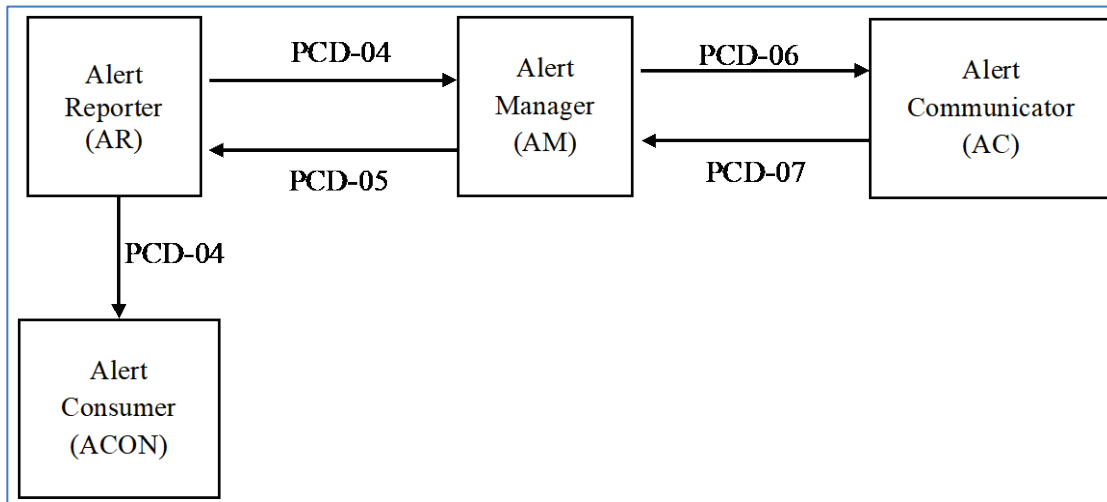

Figure 67 IHE PCD ACM Profile Actor / Transaction Flow Diagram

The following table provides an overview of the profile’s actors and transactions:

3335

Actors	Transactions	Direction	Optionality	Section in Vol. 2
Alert Reporter (AR)	Report Alert [PCD-04]	Outbound	R	3.4
	Report Alert Status [PCD-05]	Inbound	O	3.5
Alert Manager (AM)	Report Alert [PCD-04]	Inbound	R	3.4
	Disseminate Alert [PCD-06]	Outbound	R	3.6
	Report Dissemination Alert Status [PCD-07]	Inbound	R	3.7
	Report Alert Status [PCD-05]	Outbound	O	3.5
Alert Consumer	Report Alert [PCD-04]	Inbound	R	3.7
Alert Communicator (AC)	Disseminate Alert [PCD-06]	Inbound	R	3.6
	Report Dissemination Alert Status [PCD-07]	Outbound	R	3.7

Figure 68 IHE PCD ACM Actors & Transaction Table

And the following profile options are supported:

Actor	Options	Section in Volume 2
AR	May send additional alert notification recipients in PCD-04	B.7.1.1
AR	Receives Report Alert Status in PCD-05	B.7.1.1
AR	Can send WCM data in PCD-04	B.7.1.1
AM	Processes additional alert notification recipients in PCD-04	B.7.1.1
AM	Sends Report Alert Status in PCD-05	B.7.1.1
AM	Can send WCM data from PCD-04 in PCD-06	B.7.1.1
AM	Can send WCM PCD-04 based data as graphical snippet in PCD-06	B.7.1.1
ACON	Can receive WCM data in PCD-04	B.7.1.1
AC	Can receive WCM evidentiary data in PCD-06 and present graphics	B.7.1.1
AC	Can receive WCM graphics snippet in PCD-06 and present it	B.7.1.1
AM	Disseminate and Report Alert Status (in support of ITI mACM)	B.7.1.1
ACON	Disseminate and Report Alert Status (in support of ITI mACM)	B.7.1.1

Figure 69 IHE PCD ACM Profile Options Table

Terminology is easily overloaded with different meanings, including what is meant by alert, event, alarm, technical, physiological, etc. The following diagram presents the IHE perspective on these terms:

3340

3345

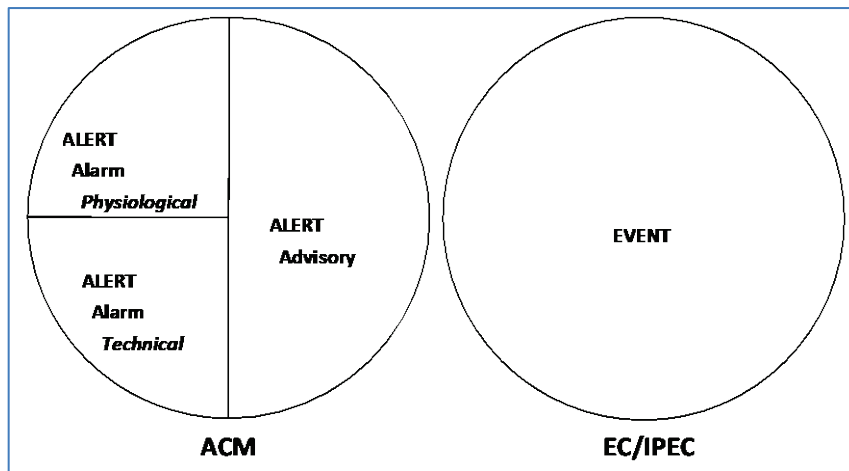

Figure 70 IHE PCD - Alerts vs. Events

As further explained in the IHE PCD TF-1 ACM Profile:

ACM is an alert (alarms and advisories) distribution solution providing the following:

- 3350 ○ Communication from an alert gateway to an alert consumer, manager, or distributor
- Communication to an alert communicator for dissemination to people using both wired and wireless communication devices, typically clinicians, physicians, or other healthcare staff, for responding to patient needs or related workflows

3355 The primary use of the IHE PCD Alert Communications Management Profile is to serve in communication of alert information from alert reporting systems, such as patient care devices, location service systems (LS/RTLS/Rfid), or equipment management systems (CMMS/CEMS) to an alert manager system communicating with additional means of notification to caregivers. Notification devices would include those capable of supporting this profile, in particular [PCD- 06] and [PCD-07].

3360 C.4 PCD Profile: Point-of-care Infusion Verification (PIV)

Overview:

TF Reference: IHE PCD ...

Status: Trial Implementation / Tested at ... / <implementations?>

Use Case Scope:

3365 PIV.1 - Transfer of infusion parameters from BPOC to infusion device

SDPi Use: Possible integration with SDPi-xC Profile; future integration into an infusion pump device specialization profile.

This profile supports the clinical workflow illustrated in the following diagram:

3370

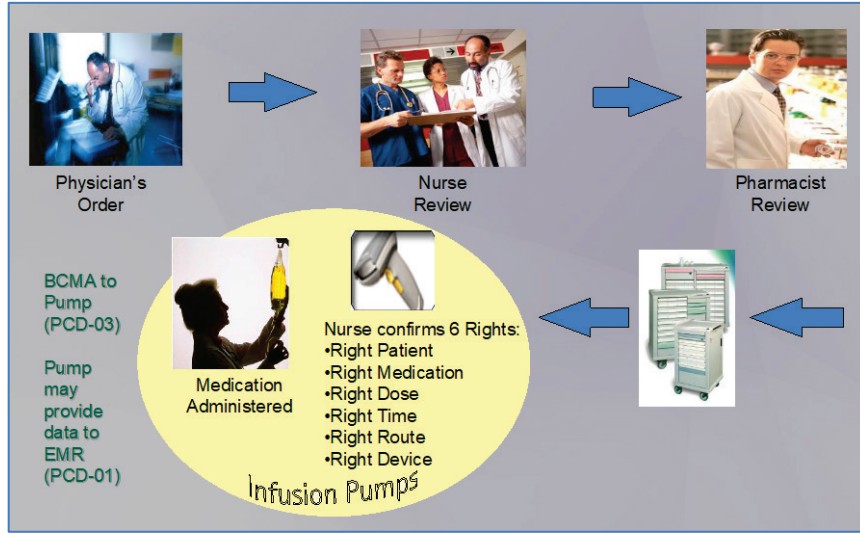

Figure 71 Point-of-care Infusion (6 Rights) Verification (PIV) Use Case

The following PIV actor diagram supports the above use case:

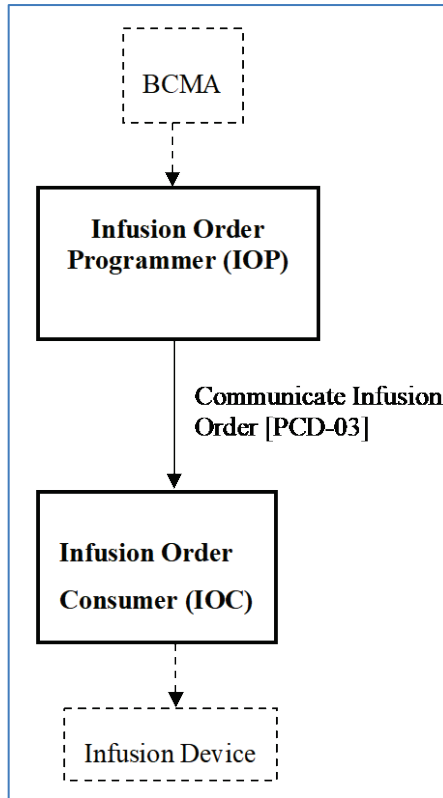

Figure 72 IHE PCD PIV Profile Actor Diagram

3375

Note: The PIV Profile does not specify any actor options.

C.5 PCD Profile: Infusion Pump Event Communication (IPEC)

Overview:

3380 **TF Reference:** IHE PCD ...
 Status: Trial Implementation / Tested at ... / <implementations?>
 Use Case Scope:
 IPEC.1 - Communicate event data to EMR/EHR
3385 **SDPi Use:** Gateway supporting mapping from SDPi-R infusion device event reporting

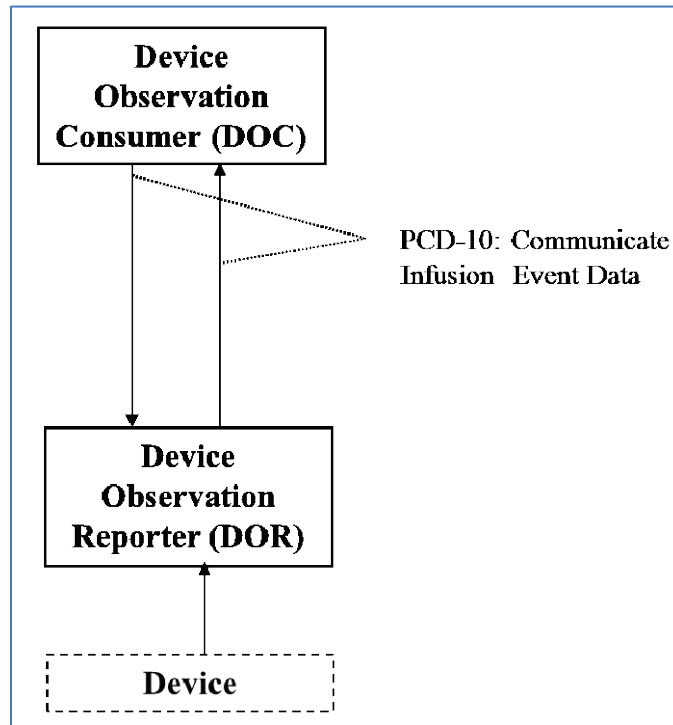

Figure 73 IHE PCD IPEC Actor Diagram

3390 The following graphic provides an example of the events that might be generated when the rate is changed on an infusion pump.

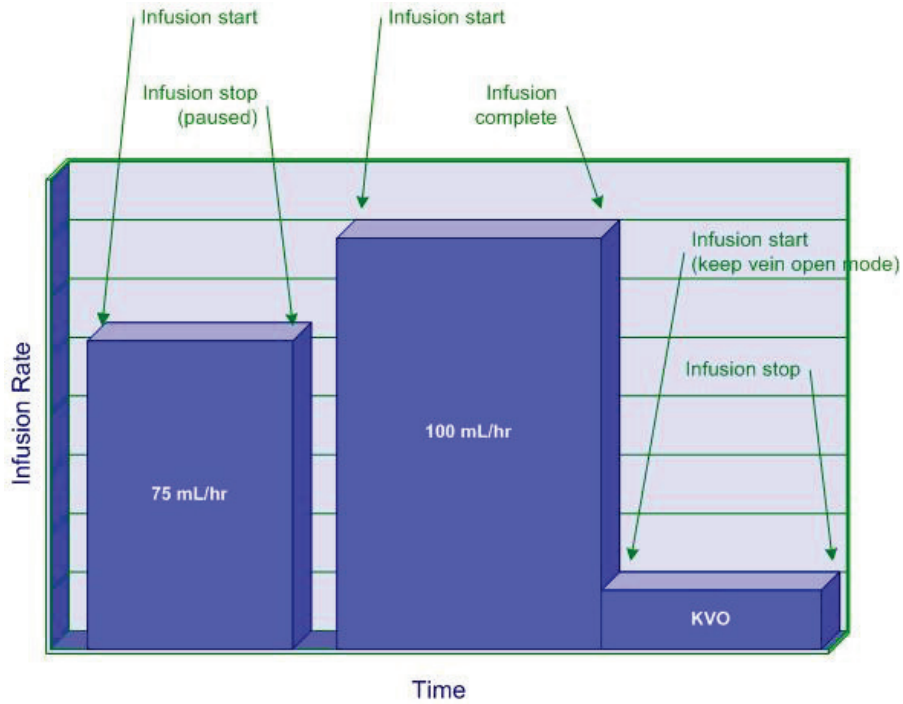

Figure 74 IHE PCD IPEC - Example Event Sequence

3395 **C.6 PCD Profile: Point-of-Care Identity Management (PCIM)**

Overview:

TF Reference: IHE PCD ...

Status: Trial Implementation / Tested at ... / <implementations?>

Use Case Scope:

3400

PCIM.1 - Associating Device with Patient

PCIM.2 - Disassociating Device from Patient

PCIM.3 - Query for the Devices for a Patient

PCIM.4 - Query the Associated Patient for a Device

PCIM.5 - Device Registrant Registers a Device

3405

PCIM.6 - Query the Device Registrant for a list of candidate devices for an association

SDPi Use: ...

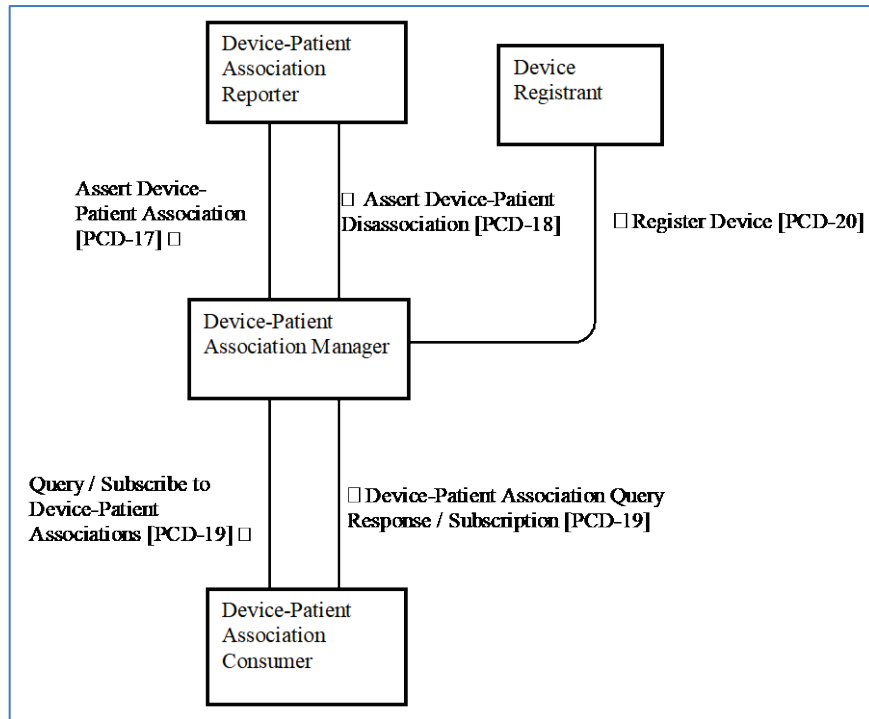

3410

Figure 75 IHE PCD PCIM Profile – Actor Model

Actor	Option Name	Reference
Device-Patient Association Consumer	Snapshot Option	7.2.1
Device-Patient Association Consumer	Subscription Option	7.2.2
Device-Patient Association Manager	Snapshot Option	7.2.1
Device-Patient Association Manager	Subscription Option	7.2.2
Device-Patient Association Reporter	No options defined	
Device Registrant	No options defined	

Figure 76 IHE PCD PCIM Profile – Options

3415

C.7 PCD Profile: Rosetta Terminology Mapping (RTM)

3420

The PCD Rosetta Terminology Mapping (RTM)⁸⁸ project was born out of the recognition that many vendors with the same general type of equipment (e.g., physiological monitor) provide the same core semantic content but use different proprietary terminology or nomenclature. Thus the “Rosetta” concept of mapping from a vendor-specific semantic representation to a harmonized representation using the IEEE 11073-1010x semantic standards.

In addition to this basic mapping, RTM seeks to formalize a set of “co-constraints” specifying the domain of values that are appropriate for a given parameter, such as the units of measurement that might be appropriate for a breath rate or a drug amount to be infused. This has potential to

⁸⁸ See IHE PCD TF-1 Appendix A for more detail.

3425 greatly impact patient safety by enabling not only rigorous semantic content validation during CAT and CA testing but also in real-time for safety critical applications.

These device-specific value sets are the subject matter of IHE PCD TF-3 Semantic Content and are formalized in the NIST RTM Management System (RTMMS) tool.⁸⁹

C.8 ITI Profile: XDS on FHIR – Mobile Access to Health Documents (MHD)

3430 Overview:

TF Reference: IHE PCD ...
Status: Trial Implementation / Tested at ... / <implementations?>
Use Case Scope: HL7 FHIR-enabled mobile device provide and retrieve documents to an XDS.b infrastructure

3435 **SDPi Use:** Example of how SDPi actors might be grouped with those from other profiles. No direct functional impact on SDPi.

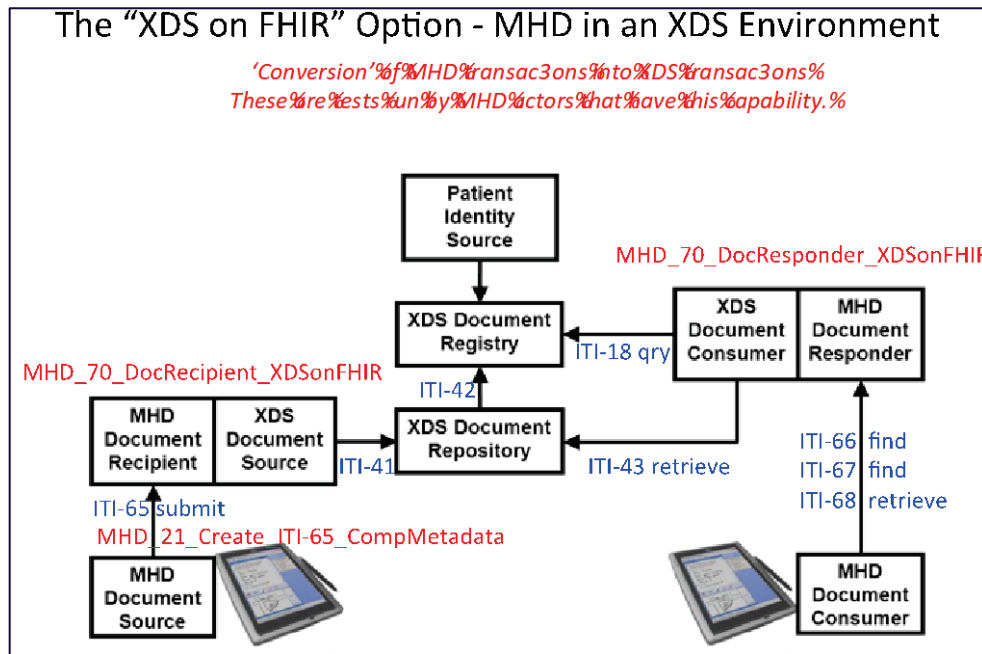

3440

Figure 77 IHE MHD "XDS on FHIR" Model

⁸⁹ See <https://rtmms.nist.gov/rtmms/index.htm>.

Appendix D – Compendium of Medical Device Oriented Use Cases

The following table lists medical device interoperability relevant use cases collected from a variety of sources including:

- ASTM F2761 (ICE) Standard
- 3445 • IHE PCD Profiles
- OR.NET
- NITRD
- ONC

3450 Note: Detailed descriptions of the use cases listed below are provided in a separate document for reference purposes. That document is not an official part of this white paper; however, a link to that document “Use Cases for SDPi White Paper” can be found on the IHE PCD SDPi White Paper Wiki.⁹⁰

INTEGRATED CLINICAL ENVIRONMENT (ICE) CLINICAL SCENARIOS	
UC.1	ICE.1 - SAFETY INTERLOCKS
UC.2	ICE.2 - SYNCHRONIZATION WITH SAFETY INTERLOCK
UC.3	ICE.3 - PROCESS CONTROL (WORKFLOW)
UC.4	ICE.4 - SMART ALARM SYSTEM
UC.5	ICE.5 - DECISION SUPPORT
UC.6	ICE.6 - PHYSIOLOGICAL CLOSED LOOP CONTROL (PCLC)
UC.7	ICE.7 - MEDICAL DEVICE PLUG-AND-PLAY INTEROPERABILITY (MD PNP)
SDC/QH – QUIET HOSPITAL (QH) SCENARIO AND USE CASES	
UC.8	SDC/QH.1 – DEVICE ALERT SIGNAL DELEGATION TO SINGLE-PT. ALERT AGGREGATOR
UC.9	SDC/QH.2 – SINGLE PT. ALERT AGGREGATOR ALERT SIGNAL DELEGATION TO MULTI-PT. AGGREGATOR
UC.10	SDC/QH.3 – DEVICE ALERT SIGNAL DELEGATION TO ALERT COMMUNICATION MANAGER
UC.11	SDC/QH.4 – MULTI-PT. AGGREGATOR TO ALERT COMMUNICATION MANAGER
UC.12	SDC/QH.5 – SDC TO FHIR GATEWAY.

⁹⁰ See https://wiki.ihe.net/index.php/SDC@IHE_White_Paper.

UC.13	SDC/QH.6 – ALERT COMMUNICATIONS MANAGER TO CARE-GIVER ALERT COMMUNICATOR
UC.14	SDC/QH.7 – ALERT COMMUNICATOR (ACM AC) FAILURE
UC.15	SDC/QH.8 – ALERT COMMUNICATIONS MANAGER (ACM AM) FAILURE
UC.16	SDC/QH.9 – MULTI-PT. AGGREGATOR FAILURE
UC.17	SDC/QH.10 – SINGLE PT. AGGREGATOR FAILURE
SDC/PDP - PREECLAMPSIA (PDP) SCENARIO AND USE CASES	
UC.18	SDC/PDP.1 - IN-HOSPITAL, AT HOME AND MOBILE / CLINIC CARE CONTEXTS
UC.19	SDC/PDP.2 - ACUTE POINT-OF-CARE MEDICAL AND PERSONAL HEALTH DEVICES
UC.20	SDC/PDP.3 - LAB RESULTS INCLUDING POINT OF CARE DEVICES AND TRANSACTIONS
UC.21	SDC/PDP.4 - LOCATION TRACKING AND DEVICE IDENTIFICATION / ASSOCIATION MANAGEMENT
UC.22	SDC/PDP.5 - A CLOUD-BASED CDS SYSTEM AND “LOCALLY” NETWORKED SYSTEMS & APPLICATIONS
SDC/FESS – ENDOSCOPIC SURGERY SCENARIO AND USE CASES	
UC.23	SDC/FESS.1 – SURGEON VIEW OF PATIENT VITALS
UC.24	SDC/FESS.2– SURGEON CONTROL OF OR TABLE AND LIGHTS
UC.25	SDC/FESS.3– SURGEON CONTROL OF SURGICAL TOOLS
UC.26	SDC/FESS.4 – DEVICE REPORTS TECHNICAL ISSUE TO RESPONSIBLE BMET
UC.27	SDC/FESS.5 – SEAMLESS EXCHANGE OF MEDICAL DEVICES
NITRD – MEDICAL DEVICE SCENARIO AND USE CASES	
UC.28	NITRD.1 – SEAMLESS CHANGES OF MEDICAL DEVICES
UC.29	NITRD.2 – CAPTURE OF DATA AND SETTINGS
UC.30	NITRD.3 – SUPERVISORY CONTROL ESTABLISHED
UC.31	NITRD.4 – AUTONOMOUS PATIENT THERAPY
UC.32	NITRD.5 – DATA FLOWS THROUGH THE CONTINUUM OF CARE
UC.33	NITRD.6 – CAPTURE OF EQUIPMENT CONFIGURATIONS
UC.34	NITRD.7 – BLACK BOX RECORDER
OR.NET USE CASES	
UC.35	ORNET.001 - INTEGRATION OF ANESTHESIA VIDEO DATA INTO (ANESTHESIOLOGIC) PATIENT MONITORING VIA RADIO TRANSMISSION
UC.36	ORNET.004 - INDICATES A WARNING FROM ONE OSCB-COMPLIANT DEVICE TO ANOTHER
UC.37	ORNET.005 - TRANSFER OF THE CONTROL OF DEVICE A BY A DEVICE B, WHICH IS ACTUALLY PROHIBITED

UC.38	ORNET.006 - USER-SPECIFIC WORKFLOW-DEPENDENT ADJUSTMENT OF THE HEIGHT OF THE OPERATING TABLE / FOOT STEP
UC.39	ORNET.009 - DISPLAY OF ELECTROPHYSIOLOGICAL SIGNALS ON A MONITOR BY A SURGEON
UC.40	ORNET.010 - USE OF A FOOT SWITCH AS AN INPUT DEVICE
UC.41	ORNET.012 - DISPLAY OF FORCE AND MOMENT SENSOR (KMS) FOR KNEE AXIS DETERMINATION ON CENTRAL MONITOR
UC.42	ORNET.016 - COLLISION AVOIDANCE OF DEVICES
UC.43	ORNET.017 - CONTROL OF A DESIRED MANIPULATOR BY A COMMON CONTROL CONSOLE
UC.44	ORNET.018 - POWER CONTROL OF THE MILLING MACHINE AT THE MIDDLE
UC.45	ORNET.019 - LINKING THE SURGICAL LIGHT TO THE ENDOSCOPE
UC.46	ORNET.024 - STORAGE OF INTRAOPERATIVE IMAGE DATA IN THE EHR
UC.47	ORNET.029 - INTRAOPERATIVE INPUT OF MONITORING DATA TO EHR
UC.48	ORNET.030 - DISPLAY OF MONITORING DATA IN MICROSCOPE IMAGE
UC.49	ORNET.032 - INSERTION OF RELEVANT INFORMATION INTO THE SURGICAL MICROSCOPE ACCORDING TO THE CLINICAL SITUATION
UC.50	ORNET.035 - CENTRAL PRESENTATION OF RELEVANT DEVICE DATA / DOCUMENTS / PATIENT DATA CLOSE TO THE SITE
UC.51	ORNET.040 - SINGLE CHECK-DESK
UC.52	ORNET.042 - PREVENTION OF EXPLOSIONS
UC.53	ORNET.043 - CONTROLLING THE US DISSECTOR WITH THE HUMAN MACHINE INTERFACE (MMI) OF THE MICROSCOPE
UC.54	ORNET.050 - SERVICE TOTAL LOG
UC.55	ORNET.051 - VISUALIZATION OF INSTRUMENT POSITION
UC.56	ORNET.051 - VISUALIZATION OF INSTRUMENT POSITION
UC.57	ORNET.067 - FUSION IMAGING INTRAOPERATIVELY US - CT / MRT
UC.58	ORNET.068 - IMAGE-BASED COMMUNICATION.
UC.59	ORNET.069 - MONITORING OF PATIENT AND DEVICE PARAMETERS, ESPECIALLY ALARMS
UC.60	ORNET.070 - CONTROL OF THE ANESTHESIOLOGICALLY RELEVANT DEVICE PARAMETERS.
UC.61	ORNET.072 - IMPORT OF CLINICAL DATA FROM THE EHR
UC.62	ORNET.073 - STORAGE OF DIGITAL PATIENT RECORDS IN THE EHR.
UC.63	ORNET.078 - OPERATING ROOM PREPARATION
UC.64	ORNET.079 - REMOTE DIAGNOSTICS REMOTE MAINTENANCE FIRMWARE UPDATE

UC.65	ORNET.082 - VIDEO DISPLAY OF SELECTED PARAMETERS FROM EXTERNAL OSCB-COMPLIANT DEVICES
UC.66	ORNET.084 - TRANSFER OF A 3D VOLUME IMAGE TO A NAVIGATION SYSTEM
UC.67	ORNET.086 - STORING AN ENDOSCOPE VIDEO
UC.68	ORNET.090 - POSITION ADJUSTMENT C-ARM AND OPERATING TABLE
UC.69	ORNET.091 - INSERTION OF TUMOR BORDERS INTO THE MICROSCOPE.
UC.70	ORNET.095 - CONTROL OF THE ENDOSCOPE LIGHT SOURCE VIA THE NAVIGATION MMI
UC.71	ORNET.096 - INTEGRATION OF B-MODE ULTRASOUND INTO NAVIGATION
UC.72	ORNET.097 - INTEGRATION OF 3D ULTRASOUND INTO NAVIGATION.
UC.73	ORNET.100 - UPLOADING PATIENT STRAIN DATA TO THE MEDICAL IT SUBNET
UC.74	ORNET.101 - COUPLING OF THE FOOTING HEIGHT TO THE SEAT HEIGHT
UC.75	ORNET.102 - DETECTION OF OSCB COMPLIANT DEVICES
UC.76	ORNET.103 - FAILURE OF OSCB COMPLIANT DEVICES
UC.77	ORNET.104 - LOGOUT OF OSCB-COMPLIANT DEVICES
UC.78	ORNET.105 - AUTOMATIC FEEDING OF PATIENT STRAIN DATA TO OSCB COMPLIANT DEVICE
UC.79	ORNET.106 - ENTER THE OPERATOR ID IN THE IT SUBNET
UC.80	ORNET.107 - AUTOMATIC INPUT OF OPERATOR CODE IN OSCB-COMPLIANT DEVICE.
UC.81	ORNET.108 - TRANSFER OF IMAGE DATA FROM THE PACS TO A MONITOR
UC.82	ORNET.109 - CREATE INTRAOPERATIVE SCREENSHOTS.
UC.83	ORNET.110 - TRANSFER REGISTRATION INFORMATION FROM THE NAVIGATION DEVICE TO THE ROBOTIC SYSTEM
UC.84	ORNET.111 - DISPLAY ADDITIONAL INFORMATION ON THE MONITOR OF THE NAVIGATION DEVICE
UC.85	ORNET.112 - LOAD PLANNING IMAGE DATA FROM THE PACS INTO THE ROBOTIC SYSTEM
UC.86	ORNET.114 - RECORDING AND ARCHIVING OF VIDEO DATA FOR DOCUMENTATION VIA A FRAME GRABBER APPLICATION
UC.87	ORNET.115 - RECORDING AND ARCHIVING OF VIDEO DATA FOR DOCUMENTATION VIA AN IP DATA STREAM
UC.88	ORNET.116 - VIEW OF DICOM OBJECTS ON ANY TERMINAL WITH DISPLAY FUNCTION
UC.89	ORNET.117 - PATIENT AND SURGICAL CENTERED DICOM OBJECT DISPLAY
UC.90	ORNET.118 - STORAGE OF DICOM OBJECTS IN DICOM OBJECT-RECORDING SYSTEMS
UC.91	ORNET.119 - CONTROL FROM A DICOM OBJECT VIEWER TO CHANGE THE LAYOUT OF A DISPLAY SCREEN

UC.92	ORNET.120 - LINKING THE OP LIGHT TO THE C-ARM
UC.93	ORNET.121 - RECONSTRUCTION OF THE OP SITUS BY LASER MEASURING POINT.
UC.94	ORNET.122 - POWER CONTROL OF THE VACUUM CLEANER ON THE CENTRAL PIPE.
UC.95	ORNET.123 - DERIVATION OF THE ALARMS OF THE SURGICAL ALARM SYSTEM TO THE OPERATING THEATER
UC.96	ORNET.124 - ALARM-TRIGGERED MANIPULATION OF THE RGB ROOM LIGHT
UC.97	ORNET.125 - SHOW WARNING SIGNALS IN VIDEOS OF MINIMALLY / NON-INVASIVE IMAGING PROCEDURES
UC.98	ORNET.126 - RE-ADJUSTMENT OF PREOPERATIVE CT DATA USING INTRAOPERATIVE DVT
UC.99	ORNET.127 - AUTOMATIC ORIENTATION OF THE STEREO CAMERA
UC.100	ORNET.128 - LOGGING THE INSTRUMENT POSITION DURING OPTICAL NAVIGATION
UC.101	ORNET.129 - TRANSFER OF A LOG TO THE LOGISTICS SYSTEM
UC.102	ORNET.130 - INTEGRATION OF NEUROMONITORING OF THE ENT AREA INTO THE OPTICAL NAVIGATION
UC.103	ORNET.131 - ADJUST THE POSITION OF THE OPERATING TABLE USING A NAVIGATED POINTER
UC.104	ORNET.132 - COMMON CONTROL INTERFACE FOR ALL DEVICES.
UC.105	ORNET.133 - AUTOMATIC DOCUMENTATION OF DEVICE PARAMETERS: BLOOD VOLUME
UC.106	ORNET.134 - AUTOMATIC DOCUMENTATION OF DEVICE PARAMETERS: SURFACE DOSE.
UC.107	ORNET.135 - COMBINATION OF ROTATIONAL ANGIOGRAPHY WITH ELECTROPHYSIOLOGICAL MEASURING SITE
UC.108	ORNET.136 - CT / MRI LINKAGE WITH TEE ULTRASOUND IN ENDOSCOPIC MITRAL VALVE SURGERY
UC.109	ORNET.137 - COMMON OPERATION OF ALL ROOM AIR-CONDITIONING UNITS FROM STERILE WORKPLACES
UC.110	ORNET.138 - AVAILABILITY OF ALL PATIENTS INFORMATION FROM STERILE WORKPLACE
UC.111	ORNET.139 - POWER CONTROL OF AN ULTRASONIC BREAKER
UC.112	ORNET.140 - INTEGRATION OF NEUROMONITORING OF THE BRAIN INTO THE RISK AREAS OF OPTICAL NAVIGATION
UC.113	ORNET.141 - INTEGRATION OF INTRAOPERATIVE ULTRASOUND DATA OF NEUROSURGERY INTO THE RISK AREAS OF OPTICAL NAVIGATION
UC.114	ORNET.142 - ADAPTATION OF DEVICE PARAMETERS TO VITAL PARAMETERS OF PATIENT
UC.115	ORNET.143 - ADAPTATION OF DEVICE PARAMETERS TO PATIENT 'S VITAL PARAMETERS

UC.116	ORNET.144 - INTEGRATION OF THE LAPAROSCOPY AND ENDOSCOPY TOWER
UC.117	ORNET.145 - LINKING THE SURGICAL COLUMN AND THE OPERATING TABLE
UC.118	ORNET.146 - WARNING IF PRESSURE IS TOO STRONG ON THE ULTRASOUND DEVICE
UC.119	ORNET.147 - CHANGE THE US DISSECTOR PARAMETERS
UC.120	ORNET.148 - REMOTE TRIGGERING OF US DISSECTOR DEVICE FUNCTIONALITIES
UC.121	ORNET.149 - US DISSECTOR INFORMS THE MICROSCOPE OF ITS CURRENT TRIGGER STATE
UC.122	ORNET.150 - REMOTE TRIPPING OF US DISSECTOR DEVICE FUNCTIONALITIES
UC.123	ORNET.151 - ACOUSTIC AND VISUAL FEEDBACK OF INTRAOPERATIVE NEUROMONITORING DURING SURGICAL PROCEDURES
UC.124	ORNET.152 - TRANSFER OF VIDEO AND IMAGE DATA
UC.125	ORNET.153 - READ IMAGE DATA FROM THE PACS
UC.126	ORNET.154 - UPLOADING IMAGE DATA TO THE PACS
UC.127	ORNET.155 - FILE IMPORT FROM THE EHR
UC.128	ORNET.156 - FILE EXPORT TO THE EHR
IHE PCD - DEVICE TO ENTERPRISE COMMUNICATION (DEC) USE CASES	
UC.129	DEC.1 - COMMUNICATE PATIENT IDENTIFIED DEC DATA TO EMR/EHR
UC.130	DEC.2 - COMMUNICATE VALIDATED PERIODIC DEC DATA TO EMR/EHR
UC.131	DEC.3 - USE CASES FOR AUTOMATIC PATIENT DEMOGRAPHICS ACQUISITION
UC.132	DEC.3.1 - PATIENT ID KNOWN IN ADT, LOCALLY AVAILABLE
UC.133	DEC.3.2 - PATIENT ID KNOWN IN ADT, NOT LOCALLY AVAILABLE
UC.134	DEC.3.3 - PATIENT ID NOT KNOWN IN ADT, LOCALLY AVAILABLE
UC.135	DEC.3.4 - PATIENT ID NOT KNOWN IN ADT, NOT LOCALLY AVAILABLE.
UC.136	DEC.3.5 OTHER CLINICAL EXAMPLES
UC.137	DEC.3.5A – ASSOCIATION OF PATIENT ID AND MEDICAL DEVICE – VIA ID LIST
UC.138	DEC.3.5B - ASSOCIATION OF PATIENT ID AND MEDICAL DEVICE – VIA PATIENT WRISTBAND
UC.139	DEC.3.5C - ASSOCIATION OF PATIENT ID AND MEDICAL DEVICE – VIA RFID TAGS
IHE PCD - DEC SUBSCRIBE TO PATIENT DATA (SPD) USE CASES	
UC.140	SPD.1: COMMUNICATE PATIENT IDENTIFIED DATA TO EMR/EHR
UC.141	SPD.2 - COMMUNICATE VALIDATED PERIODIC DATA TO EMR/EHR
UC.142	SPD.3 - SUBSCRIBE TO PATIENT DATA AT SPECIFIC PERIODIC INTERVAL.
UC.143	SPD.4 - SUBSCRIBE TO PATIENT DATA FOR SPECIFIC PATIENTS.
UC.144	SPD.5 - SUBSCRIBE TO PATIENT DATA FOR PATIENTS FROM A SPECIFIC LOCATION.

UC.145	SPD.6 - SUBSCRIBE TO PATIENT DATA FOR A SPECIFIC DEVICE OR CLASS OF DEVICES
UC.146	SPD.7 - SUBSCRIBE TO PATIENT DATA FOR SPECIFIC PARAMETERS OR CLASS OF PARAMETERS.
UC.147	SPD.8 - REQUEST A SNAPSHOT OF CURRENT OR MOST RECENT PATIENT DATA.
IHE PCD - ALERT COMMUNICATION MANAGEMENT (ACM) USE CASES	
UC.148	ACM.1 - LOCATION SOURCED
UC.149	ACM.2 - IDENTIFIED PATIENT SOURCE
UC.150	ACM.3 - SAME AS ACM.1/ACM.2 WITH ESCALATION WITH CANCEL AT ALERT SOURCE
UC.151	ACM.4 - SAME AS ACM.1/ACM.2 WITH ESCALATION WITH CANCEL AT COMMUNICATION ENDPOINT
UC.152	ACM.5 - SAME AS ACM.1/ACM.2 WITH ESCALATION WITH CANCEL AT AM
UC.153	ACM.6 - INFORMATION WITH NO DESTINATION OTHER THAN LOGGING BY THE AM
UC.154	ACM.7 - EQUIPMENT SOURCED ALERT
IHE PCD - MEDICAL EQUIPMENT MANAGEMENT DEVICE MANAGEMENT (MEMDMC) USE CASES	
UC.155	MEMDMC.1 - EQUIPMENT OBSERVATIONS TO CMMS
UC.156	MEMDMC.2 - EQUIPMENT OBSERVATIONS TO CMMS
IHE PCD - MEDICAL EQUIPMENT MANAGEMENT LOCATION SERVICES (MEMLS) USE CASES	
UC.157	MEMLS.1 - COMMUNICATION OF LOCATION OBSERVATIONS IN CONJUNCTION WITH OTHER NON-LOCATION RELATED TRANSACTIONS
UC.158	MEMLS.2 - COMMUNICATION OF LOCATION OBSERVATIONS IN CONJUNCTION WITH LS SPECIFIC EVENTS
IHE PCD - WAVEFORM CONTENT MODULE (WCM) USE CASES	
UC.159	WCM.1 - ALARM WAVEFORM SNAPSHOT
UC.160	WCM.2 - REAL-TIME WAVEFORM VIEWING
UC.161	WCM.3 - ARCHIVED WAVEFORM VIEWING
UC.162	WCM.4 - MIXED SNAPSHOT AND CONTINUOUS WAVEFORM VIEWING
UC.163	WCM.5 - WAVEFORM SNAPSHOT TO EHR
UC.164	WCM.6 12 - LEAD ECG
IHE PCD - RETROSPECTIVE DATA QUERY (RDQ) USE CASES	
UC.165	RDQ.1 - QUERY FOR ALL RETROSPECTIVE DATA ON A SINGLE PATIENT.
UC.166	RDQ.2 - QUERY FOR ALL RETROSPECTIVE DATA ON MULTIPLE PATIENTS.
UC.167	RDQ.3 - QUERY FOR RETROSPECTIVE DATA ON A SINGLE PATIENT WITHIN A SPECIFIED TIME INTERVAL.

UC.168	RDQ.4 - QUERY FOR RETROSPECTIVE DATA ON MULTIPLE PATIENTS WITHIN A SPECIFIED TIME INTERVAL.
UC.169	RDQ.5 - QUERY FOR RETROSPECTIVE DATA ON 1 OR MORE PARAMETER ELEMENTS ON A SINGLE PATIENT.
UC.170	RDQ.6 - QUERY FOR RETROSPECTIVE DATA ON 1 OR MORE PARAMETER ELEMENTS ON MULTIPLE PATIENTS.
UC.171	RDQ.7 - QUERY FOR RETROSPECTIVE DATA ON 1 OR MORE PARAMETER ELEMENTS ON A SINGLE PATIENT WITHIN A SPECIFIED TIME INTERVAL.
UC.172	RDQ.8 - QUERY FOR RETROSPECTIVE DATA ON 1 OR MORE PARAMETER ELEMENTS ON MULTIPLE PATIENTS WITHIN A SPECIFIED TIME INTERVAL.
IHE PCD - IMPLANTABLE DEVICE CARDIAC OBSERVATION (IDCO) USE CASES	
UC.173	IDCO.1 - IMPLANTABLE CARDIAC DEVICE IN-CLINIC FOLLOW-UP
UC.174	IDCO.2 - IMPLANTABLE CARDIAC DEVICE IN-CLINIC FOLLOW-UP WITH NETWORKED PROGRAMMER THAT TRANSLATES INFORMATION
UC.175	IDCO.3 - IMPLANTABLE CARDIAC DEVICE REMOTE FOLLOWUP
UC.176	IDCO.4 - REMOTE MONITORING OF IMPLANTED CARDIAC DEVICES
IHE PCD - POINT-OF-CARE INFUSION VERIFICATION (PIV) USE CASES	
UC.177	PIV.1 – TRANSFER OF INFUSION PARAMETERS FROM BPOC TO INFUSION DEVICE
IHE-PCD - INFUSION PUMP EVENT COMMUNICATION (IPEC)	
UC.178	IPEC.1: COMMUNICATE EVENT DATA TO EMR/EHR
IHE PCD - POINT-OF-CARE IDENTITY MANAGEMENT (PCIM) USE CASES	
UC.179	PCIM.1 - ASSOCIATING DEVICE WITH PATIENT
UC.180	PCIM.2 - DISASSOCIATING DEVICE FROM PATIENT
UC.181	PCIM.3 - QUERY FOR THE DEVICES FOR A PATIENT
UC.182	PCIM.4 - QUERY THE ASSOCIATED PATIENT FOR A DEVICE
UC.183	PCIM.5 - DEVICE REGISTRANT REGISTERS A DEVICE
UC.184	PCIM.6 - QUERY THE DEVICE REGISTRANT FOR A LIST OF CANDIDATE DEVICES FOR AN ASSOCIATION
CEN/TC 251/PT5-021 (VITAL) USE CASES	
UC.185	VITAL.1 - DATA LOGGER - SINGLE DEVICE
UC.186	VITAL.2 - DATA LOGGER - MULTIPLE DEVICES
UC.187	VITAL.3 - REAL-TIME DATA DISPLAY
UC.188	VITAL.4 - PATIENT ALARM MONITORING
UC.189	VITAL.5 - REMOTE CONTROL
UC.190	VITAL.6 - PATIENT VIEWING INTEROPERABILITY
UC.191	VITAL.7 - PATIENT MONITORING INTEROPERABILITY

UC.192	VITAL.8 - PATIENT DATA EXCHANGE (OFF-LINE)
UC.193	VITAL.9 - PATIENT DATA EXCHANGE (ON-LINE/INTERACTIVE)
ONC/AHIC COMMON DEVICE CONNECTIVITY USE CASES	
UC.194	AHIC.1 - CONFIGURE AND REGISTER A DEVICE TO COMMUNICATE WITH AN EHR.
UC.195	AHIC.2 - ASSOCIATE PATIENT ID AND DEVICE INFORMATION WITHIN AN EHR.
UC.196	AHIC.3 - COMMUNICATE MEASUREMENT INFORMATION TO THE EHR
UC.197	AHIC.4 - COMMUNICATE DEVICE META-DATA WITH EACH MEASUREMENT TO THE EHR.
UC.198	AHIC.5 - COMMUNICATE MEASUREMENT INTERVALS, ETC. WITHIN THE EHR.
UC.199	AHIC.6 - QUERY THE DEVICE OR DEVICE INTERMEDIARY FOR ADDITIONAL INFORMATION.
UC.200	AHIC.7 – GRACEFULLY RECOVER FROM A LAPSE IN EHR CONNECTIVITY.
UC.201	AHIC.8 - COMMUNICATE STANDARDIZED ALARM TYPES TO THE EHR.
UC.202	AHIC.9 - SET LIMITS AND SAFEGUARDS FOR DEVICE SETTINGS FROM THE EHR TO A DEVICE.
UC.203	AHIC.10 - WIRELESSLY COMMUNICATE POC DEVICE INFORMATION FROM THE DEVICE TO A DEVICE INTERMEDIARY OR EHR.
“SPECIAL” PATIENT MONITORING USE CASES	
UC.204	PM.1 - SYNCHRONIZED CARDIOVERSION
UC.205	PM.2 - INTRA-AORTIC BALLOON PUMP SYNCHRONIZATION
UC.206	PM.3 - CATHETER INSERTION PROCEDURE
UC.207	PM.4 - THE USER “COCKPIT”

3455

Appendix E – SDC Message Examples

Nothing beats seeing some real-world examples of communication exchanges, and that includes SDC-based messages. This appendix provides examples of SDC messages that were captured in actual interactions between devices, systems and applications. It is not an exhaustive set; however, hopefully it facilitates understanding.

Note: Where appropriate, references are made to earlier diagrams that indicate when a given example message might be appropriate.

Message Examples

<u>AR01</u>	<u>Episodic Alert Report</u>
<u>DNA01</u>	<u>Get Context States</u>
<u>DNA02</u>	<u>Get Contest States Response</u>
<u>EC01</u>	<u>Activate Audio Pause</u>
<u>EC03</u>	<u>Operation Invoked Report - Fin(ished)</u>
<u>EC04</u>	<u>Operation Invoked Report - Wait</u>
<u>MR00</u>	<u>Subscription Request</u>
<u>MR00a</u>	<u>Subscription Response</u>
<u>MR01</u>	<u>Episodic Metric Report</u>
<u>MR02</u>	<u>Waveform Stream</u>

General MDPWS Messaging Notes

1. Each message has an editorial identifying label (e.g., AR01 for Alert Report example #1); these will be used for references from the main white paper content.
2. Message order is per “label” ... live with it ...

3. WS-* uses standard SOAP messages with an “Envelope” element that contains a “Header” providing addressing and related information, followed by a message “Body” that has the actual message content.
4. The BICEPS to MDPWS definitions are provided publicly @ <http://standards.ieee.org/downloads/11073/11073-10207-2017/>
5. ...

SDC Message: AR01 – Episodic Alert Report

Context:

SOAP Message:

```
<?xml version="1.0" encoding="UTF-8"?>
<s12:Envelope xmlns:msg="http://standards.ieee.org/downloads/11073/11073-10207-2017/message"
xmlns:pm="http://standards.ieee.org/downloads/11073/11073-10207-2017/participant"
xmlns:s12="http://www.w3.org/2003/05/soap-envelope" xmlns:wsa="http://www.w3.org/2005/08/addressing"
xmlns:wse="http://schemas.xmlsoap.org/ws/2004/08/eventing" xmlns:xsi="http://www.w3.org/2001/XMLSchema-instance">
  <s12:Header>
    <wsa:To>http://191.1.1.53:64420</wsa:To>
    <wsa:Action>http://standards.ieee.org/downloads/11073/11073-20701-
2018/StateEventService/EpisodicAlertReport</wsa:Action>
    <wsa:MessageID>urn:uuid:70370a73-b988-42bd-8b06-954b00a0adec</wsa:MessageID>
    <wse:Identifier>urn:uuid:80c308f6-3eca-4598-92a6-0932b3b3d9b9</wse:Identifier>
  </s12:Header>
  <s12:Body>
    <msg:EpisodicAlertReport MdibVersion="140" SequenceId="urn:uuid:b8615892-f5fb-4b52-8856-bb37b6379a0c">
      <msg:ReportPart>
        <msg:AlertState xsi:type="pm:LimitAlertConditionState" DescriptorVersion="0" StateVersion="26"
ActivationState="On" Presence="true" MonitoredAlertLimits="LoOff" DescriptorHandle="AC.2868.41.852.1">
          <pm:Limits Upper="45"/>
        </msg:AlertState>
        <msg:AlertState xsi:type="pm:AlertSystemState" DescriptorVersion="0" StateVersion="32"
ActivationState="On" LastSelfCheck="1563195019454" SelfCheckCount="32"
PresentPhysiologicalAlarmConditions="AC.2868.41.852.1" PresentTechnicalAlarmConditions="" DescriptorHandle="Asy.2868"/>
      </msg:ReportPart>
    </msg:EpisodicAlertReport>
  </s12:Body>
</s12:Envelope>
```

SDC Message: DNA01 – Get Context States

Context:

SOAP Message:

```
<?xml version="1.0" encoding="UTF-8"?>
<s12:Envelope xmlns:msg="http://standards.ieee.org/downloads/11073/11073-10207-2017/message"
xmlns:s12="http://www.w3.org/2003/05/soap-envelope" xmlns:wsa="http://www.w3.org/2005/08/addressing"
xmlns:xsi="http://www.w3.org/2001/XMLSchema-instance">
  <s12:Header>
    <wsa:To>http://191.1.1.53:53716/8f9bdd66522e11e995eb5ce0c560747a/StateEvent</wsa:To>
    <wsa:Action>http://standards.ieee.org/downloads/11073/11073-20701-
2018/ContextService/GetContextStates</wsa:Action>
    <wsa:MessageID>urn:uuid:76a04520-3a9a-4171-81f7-c2803c9048cd</wsa:MessageID>
  </s12:Header>
  <s12:Body>
    <msg:GetContextStates/>
  </s12:Body>
</s12:Envelope>
```

SDC Message: DNA02 – Get Context States Response

Context:

SOAP Message:

```
<?xml version="1.0" encoding="UTF-8"?>
<s12:Envelope xmlns:msg="http://standards.ieee.org/downloads/11073/11073-10207-2017/message"
xmlns:pm="http://standards.ieee.org/downloads/11073/11073-10207-2017/participant"
xmlns:s12="http://www.w3.org/2003/05/soap-envelope" xmlns:wsa="http://www.w3.org/2005/08/addressing"
xmlns:xsi="http://www.w3.org/2001/XMLSchema-instance">
  <s12:Header>
    <wsa:To>http://www.w3.org/2005/08/addressing/anonymous</wsa:To>
    <wsa:Action>http://standards.ieee.org/downloads/11073/11073-10207-
2017/message/ContextService/GetContextStatesResponse</wsa:Action>
    <wsa:MessageID>urn:uuid:99e010c2-29aa-4f46-ad91-451e2f3789f0</wsa:MessageID>
    <wsa:RelatesTo>urn:uuid:76a04520-3a9a-4171-81f7-c2803c9048cd</wsa:RelatesTo>
  </s12:Header>
  <s12:Body>
    <msg:GetContextStatesResponse MdibVersion="13463" SequenceId="urn:uuid:1667f814-d173-4c07-9b05-7db1cb2a460c">
```

```
<msg:ContextState xsi:type="pm:LocationContextState" DescriptorVersion="0" StateVersion="0"
Handle="f3464655c0224aabb6df95d4b17e25e2" ContextAssociation="Assoc" BindingMdbVersion="7" DescriptorHandle="LC.mds0">
  <pm:Validator Root="Validator" Extension="System"/>
  <pm:Identification Root="sdc.ctxt.loc.detail" Extension="HOSP1/ICU1/Bed6"/>
  <pm:LocationDetail PoC="ICU1" Bed="Bed6" Facility="HOSP1"/>
</msg:ContextState>
</msg:GetContextStatesResponse>
</s12:Body>
</s12:Envelope>
```

SDC Message: EC01 – Activate Audio Pause

Context:

SOAP Message:

```
<?xml version="1.0" encoding="UTF-8"?>
<s12:Envelope xmlns:msg="http://standards.ieee.org/downloads/11073/11073-10207-2017/message"
xmlns:s12="http://www.w3.org/2003/05/soap-envelope" xmlns:wsa="http://www.w3.org/2005/08/addressing"
xmlns:xsi="http://www.w3.org/2001/XMLSchema-instance">
  <s12:Header>
    <wsa:To>http://191.1.1.53:53716/8f9bdd66522e11e995eb5ce0c560747a/Set</wsa:To>
    <wsa:Action >http://standards.ieee.org/downloads/11073/11073-20701-2018/SetService/Activate</wsa:Action>
    <wsa:MessageID>urn:uuid:69b59ef5-7b63-4ad8-a9e2-9f993af6e25a</wsa:MessageID>
  </s12:Header>
  <s12:Body>
    <msg:Activate>
      <msg:OperationHandleRef>SVO.33.mds0</msg:OperationHandleRef>
    </msg:Activate>
  </s12:Body>
</s12:Envelope>
```

SDC Message: EC03 – Operation Invoked Report – Fin(ished)

Context:

SOAP Message:

```
<?xml version="1.0" encoding="UTF-8"?>
<s12:Envelope xmlns:s12="http://www.w3.org/2003/05/soap-envelope" xmlns:wsa="http://www.w3.org/2005/08/addressing"
xmlns:wse="http://schemas.xmlsoap.org/ws/2004/08/eventing" xmlns:xsi="http://www.w3.org/2001/XMLSchema-instance"
xmlns:msg="http://standards.ieee.org/downloads/11073/11073-10207-2017/message">
  <s12:Header>
    <wsa:To>http://191.1.1.53:53995</wsa:To>
    <wsa:Action>http://standards.ieee.org/downloads/11073/11073-20701-
2018/SetService/OperationInvokedReport</wsa:Action>
    <wsa:MessageID>urn:uuid:1799c48a-fe44-4092-8f0a-507fe055f8e3</wsa:MessageID>
    <wse:Identifier>urn:uuid:80c308f6-3eca-4598-92a6-0932b3b3d9b9</wse:Identifier>
  </s12:Header>
  <s12:Body>
    <msg:OperationInvokedReport MdibVersion="5432" SequenceId="urn:uuid:1667f814-d173-4c07-9b05-7db1cb2a460c">
      <msg:ReportPart OperationHandleRef="SVO.33.mds0">
        <msg:InvocationInfo>
          <msg:TransactionId>2</msg:TransactionId>
          <msg:InvocationState>Fin</msg:InvocationState>
        </msg:InvocationInfo>
        <msg:InvocationSource/>
      </msg:ReportPart>
    </msg:OperationInvokedReport>
  </s12:Body>
</s12:Envelope>
```

SDC Message: EC04 – Operational Invoked Report - Wait

Context:

SOAP Message:

```
<?xml version="1.0" encoding="UTF-8"?>
<s12:Envelope xmlns:s12="http://www.w3.org/2003/05/soap-envelope" xmlns:wsa="http://www.w3.org/2005/08/addressing"
xmlns:wse="http://schemas.xmlsoap.org/ws/2004/08/eventing" xmlns:xsi="http://www.w3.org/2001/XMLSchema-instance"
xmlns:msg="http://standards.ieee.org/downloads/11073/11073-10207-2017/message">
```

```
xsi:schemaLocation="http://standards.ieee.org/downloads/11073/11073-10207-2017/message
file:///C:/Users/schlichs/Development/mdibgenerator/Schema/BICEPS_MessageModel.xsd">
  <s12:Header>
    <wsa:To>http://191.1.1.53:53995</wsa:To>
    <wsa:Action>http://standards.ieee.org/downloads/11073/11073-20701-
2018/SetService/OperationInvokedReport</wsa:Action>
    <wsa:MessageID>urn:uuid:1da0b6e4-6alc-48bb-9ae6-dfe12509a4f2</wsa:MessageID>
    <wse:Identifier>urn:uuid:80c308f6-3eca-4598-92a6-0932b3b3d9b9</wse:Identifier>
  </s12:Header>
  <s12:Body>
    <msg:OperationInvokedReport MdibVersion="5432" SequenceId="urn:uuid:1667f814-d173-4c07-9b05-7db1cb2a460c">
      <msg:ReportPart OperationHandleRef="SVO.33.mds0">
        <msg:InvocationInfo>
          <msg:TransactionId>2</msg:TransactionId>
          <msg:InvocationState>Wait</msg:InvocationState>
        </msg:InvocationInfo>
        <msg:InvocationSource/>
      </msg:ReportPart>
    </msg:OperationInvokedReport>
  </s12:Body>
</s12:Envelope>
```

SDC Message: MR00 – Subscription Request

Context:

SOAP Message:

```
<?xml version="1.0" encoding="UTF-8"?>
<s12:Envelope xmlns:s12="http://www.w3.org/2003/05/soap-envelope" xmlns:wsa="http://www.w3.org/2005/08/addressing"
xmlns:wse="http://schemas.xmlsoap.org/ws/2004/08/eventing" xmlns:xsi="http://www.w3.org/2001/XMLSchema-instance"
xsi:schemaLocation="http://standards.ieee.org/downloads/11073/11073-10207-2017/message
file:///C:/Users/schlichs/Development/mdibgenerator/Schema/BICEPS_MessageModel.xsd">
  <s12:Header>
    <wsa:To>http://191.1.1.53:53716/8f9bdd66522e11e995eb5ce0c560747a/StateEvent</wsa:To>
    <wsa:Action>http://schemas.xmlsoap.org/ws/2004/08/eventing/Subscribe</wsa:Action>
    <wsa:MessageID>urn:uuid:d1561550-9f6f-4904-ae01-735f48eda3f7</wsa:MessageID>
  </s12:Header>
  <s12:Body>
```

```
<wse:Subscribe>
  <wse:EndTo>
    <wsa:Address>http://191.1.1.53:54682</wsa:Address>
    <wsa:ReferenceParameters>
      <wse:Identifier>urn:uuid:eed4309e-8681-4132-9c7b-a7396fe0f627</wse:Identifier>
    </wsa:ReferenceParameters>
  </wse:EndTo>
  <wse:Delivery Mode="http://schemas.xmlsoap.org/ws/2004/08/eventing/DeliveryModes/Push">
    <wse:NotifyTo>
      <wsa:Address>http://191.1.1.53:54682</wsa:Address>
      <wsa:ReferenceParameters>
        <wse:Identifier>urn:uuid:80c308f6-3eca-4598-92a6-0932b3b3d9b9</wse:Identifier>
      </wsa:ReferenceParameters>
    </wse:NotifyTo>
  </wse:Delivery>
  <wse:Expires>P0Y0M0DT1H0M0S</wse:Expires>
  <wse:Filter Dialect="http://docs.oasis-open.org/ws-
dd/ns/dpws/2009/01/Action">http://standards.ieee.org/downloads/11073/11073-20701-
2018/DescriptionEventService/DescriptionModificationReport http://standards.ieee.org/downloads/11073/11073-20701-
2018/StateEventService/EpisodicOperationalStateReport http://standards.ieee.org/downloads/11073/11073-20701-
2018/StateEventService/EpisodicComponentReport http://standards.ieee.org/downloads/11073/11073-20701-
2018/WaveformService/WaveformStream http://standards.ieee.org/downloads/11073/11073-20701-
2018/ContextService/EpisodicContextReport http://standards.ieee.org/downloads/11073/11073-20701-
2018/StateEventService/EpisodicAlertReport http://standards.ieee.org/downloads/11073/11073-20701-
2018/StateEventService/EpisodicMetricReport</wse:Filter>
</wse:Subscribe>
</s12:Body>
</s12:Envelope>
```

SDC Message: MR00A – Subscription Response

Context:

SOAP Message:

```
<?xml version="1.0" encoding="UTF-8"?>
<s12:Envelope xmlns:s12="http://www.w3.org/2003/05/soap-envelope" xmlns:wsa="http://www.w3.org/2005/08/addressing"
xmlns:wse="http://schemas.xmlsoap.org/ws/2004/08/eventing" xmlns:xsi="http://www.w3.org/2001/XMLSchema-instance"
xsi:schemaLocation="http://standards.ieee.org/downloads/11073/11073-10207-2017/message
file:///C:/Users/schlichs/Development/mdibgenerator/Schema/BICEPS_MessageModel.xsd">
```

```
<s12:Header>
  <wsa:To>http://www.w3.org/2005/08/addressing/anonymous</wsa:To>
  <wsa:Action>http://schemas.xmlsoap.org/ws/2004/08/eventing/SubscribeResponse</wsa:Action>
  <wsa:MessageID>urn:uuid:dd86e290-75a9-4f14-b7d6-8fbee11bb022</wsa:MessageID>
  <wsa:RelatesTo>urn:uuid:d1561550-9f6f-4904-ae01-735f48eda3f7</wsa:RelatesTo>
</s12:Header>
<s12:Body>
  <wse:SubscribeResponse>
    <wse:SubscriptionManager>
      <wsa:Address>http://191.1.1.53:53716/8f9bdd66522e11e995eb5ce0c560747a/StateEvent</wsa:Address>
      <wsa:ReferenceParameters>
        <wse:Identifier>urn:uuid:551f03f0-0dce-422f-824a-392f0c1b1226</wse:Identifier>
      </wsa:ReferenceParameters>
    </wse:SubscriptionManager>
    <wse:Expires>POY0M0DT0H59M59S</wse:Expires>
  </wse:SubscribeResponse>
</s12:Body>
</s12:Envelope>
```

SDC Message: MR01 – Episodic Metric Report

Context:

SOAP Message:

```
<?xml version="1.0" encoding="UTF-8"?>
<s12:Envelope xmlns:msg="http://standards.ieee.org/downloads/11073/11073-10207-2017/message"
  xmlns:pm="http://standards.ieee.org/downloads/11073/11073-10207-2017/participant"
  xmlns:s12="http://www.w3.org/2003/05/soap-envelope" xmlns:wsa="http://www.w3.org/2005/08/addressing"
  xmlns:wse="http://schemas.xmlsoap.org/ws/2004/08/eventing" xmlns:xsi="http://www.w3.org/2001/XMLSchema-instance">
  <s12:Header>
    <wsa:To>http://191.1.1.53:64420</wsa:To>
    <wsa:Action>http://standards.ieee.org/downloads/11073/11073-20701-2018/StateEventService/EpisodicMetricReport</wsa:Action>
    <wsa:MessageID>urn:uuid:980d3c0f-1237-4e13-a41a-855a8f72c043</wsa:MessageID>
    <wse:Identifier>urn:uuid:80c308f6-3eca-4598-92a6-0932b3b3d9b9</wse:Identifier>
  </s12:Header>
  <s12:Body>
    <msg:EpisodicMetricReport MdibVersion="139" SequenceId="urn:uuid:b8615892-f5fb-4b52-8856-bb37b6379a0c">
      <msg:ReportPart>
```

```
        <msg:MetricState xsi:type="pm:NumericMetricState" DescriptorHandle="3445" DescriptorVersion="0"
StateVersion="28">
            <pm:MetricValue DeterminationTime="1563195019435" Value="34" xsi:type="pm:NumericMetricValue">
                <pm:MetricQuality Validity="Vld"/>
            </pm:MetricValue>
        </msg:MetricState>
        <msg:MetricState xsi:type="pm:NumericMetricState" DescriptorHandle="766" DescriptorVersion="0"
StateVersion="28">
            <pm:MetricValue DeterminationTime="1563195019435" Value="56" xsi:type="pm:NumericMetricValue">
                <pm:MetricQuality Validity="Vld"/>
            </pm:MetricValue>
        </msg:MetricState>
        <msg:MetricState xsi:type="pm:NumericMetricState" DescriptorHandle="852" DescriptorVersion="0"
StateVersion="30">
            <pm:MetricValue DeterminationTime="1563195019435" Value="96" xsi:type="pm:NumericMetricValue">
                <pm:MetricQuality Validity="Vld"/>
            </pm:MetricValue>
        </msg:MetricState>
    </msg:ReportPart>
</msg:EpisodicMetricReport>
</s12:Body>
</s12:Envelope>
```

SDC Message: MR02 – Waveform Stream

Context:

SOAP Message:

```
<?xml version="1.0" encoding="UTF-8"?>
<s12:Envelope xmlns:pm="http://standards.ieee.org/downloads/11073/11073-10207-2017/participant"
xmlns:s12="http://www.w3.org/2003/05/soap-envelope" xmlns:wsa="http://www.w3.org/2005/08/addressing"
xmlns:msg="http://standards.ieee.org/downloads/11073/11073-10207-2017/message"
xmlns:wse="http://schemas.xmlsoap.org/ws/2004/08/eventing" xmlns:xsi="http://www.w3.org/2001/XMLSchema-instance">
    <s12:Header>
        <wsa:To s12:mustUnderstand="true">http://191.1.1.53:53723</wsa:To>
        <wsa:Action s12:mustUnderstand="true">http://standards.ieee.org/downloads/11073/11073-20701-
2018/WaveformService/WaveformStream</wsa:Action>
        <wsa:MessageID>urn:uuid:1fae7c90-a7a2-4c77-9d05-aed28a2a4826</wsa:MessageID>
        <wse:Identifier>urn:uuid:80c308f6-3eca-4598-92a6-0932b3b3d9b9</wse:Identifier>
```

```
</s12:Header>
<s12:Body>
  <msg:WaveformStream MdibVersion="147" SequenceId="urn:uuid:1667f814-d173-4c07-9b05-7db1cb2a460c">
    <msg:State xsi:type="pm:RealTimeSampleArrayMetricState" DescriptorHandle="2666" DescriptorVersion="0"
StateVersion="127" ActivationState="On">
      <pm:MetricValue DeterminationTime="1563202114723" Samples="20.305 20.8 21.29 21.79 22.285 22.78 23.275
23.77 24.265 24.76" xsi:type="pm:SampleArrayValue">
        <pm:MetricQuality Validity="Vld"/>
      </pm:MetricValue>
    </msg:State>
  </msg:WaveformStream>
</s12:Body>
</s12:Envelope>
```