



5

**IHE Endoscopy  
Technical Framework Supplement**

10

**Endoscopy Report and Pathology Order  
(ERPO)**

15

**Trial Implementation**

20 Date: December 14, 2015  
Author: IHE Endoscopy Technical Committee  
Email: [endoscopy@ihe.net](mailto:endoscopy@ihe.net)

25

**Please verify you have the most recent version of this document. See [here](#) for Trial Implementation and Final Text versions and [here](#) for Public Comment versions.**

## Foreword

30 This is a supplement to the forthcoming IHE Endoscopy Technical Framework. Each supplement undergoes a process of public comment and trial implementation before being incorporated into the volumes of the Technical Frameworks.

This supplement is published on December 14, 2015 for Trial Implementation and may be available for testing at subsequent IHE Connectathons. The supplement may be amended based on the results of testing. Following successful testing it will be incorporated into the forthcoming  
35 Endoscopy Technical Framework. Comments are invited and may be submitted at [http://www.ihe.net/endoscopy\\_Public\\_Comments](http://www.ihe.net/endoscopy_Public_Comments).

This supplement may describe changes to the existing technical framework documents.

“Boxed” instructions like the sample below indicate to the Volume Editor how to integrate the relevant section(s) into the relevant Technical Framework volume.

40 

<i>Amend Section X.X by the following:</i>
--

Where the amendment adds text, make the added text **bold underline**. Where the amendment removes text, make the removed text **~~bold strikethrough~~**. When entire new sections are added, introduce with editor’s instructions to “add new text” or similar, which for readability are not bolded or underlined.

45

General information about IHE can be found at: [www.ihe.net](http://www.ihe.net).

Information about the IHE Endoscopy domain can be found at: [http://www.ihe.net/IHE\\_Domains](http://www.ihe.net/IHE_Domains).

50 Information about the organization of IHE Technical Frameworks and Supplements and the process used to create them can be found at: [http://www.ihe.net/IHE\\_Process](http://www.ihe.net/IHE_Process) and <http://www.ihe.net/Profiles>.

The current version of the IHE Endoscopy Technical Framework can be found at: [http://www.ihe.net/Technical\\_Frameworks](http://www.ihe.net/Technical_Frameworks).

55

## CONTENTS

	Introduction to this Supplement.....	5
	Open Issues and Questions .....	5
60	Closed Issues .....	5
	General Introduction .....	6
	Appendix A - Actor Summary Definitions .....	6
	Appendix B - Transaction Summary Definitions .....	6
	Glossary .....	6
65	<b>Volume 1 – Profiles .....</b>	<b>7</b>
	Copyright Licenses.....	7
	Domain-specific additions .....	7
	X ERPO Profile.....	7
	X.1 ERPO Actors, Transactions, and Content Modules .....	7
70	X.1.1 Actor Descriptions and Actor Profile Requirements.....	9
	X.2 ERPO Actor Options.....	9
	X.3 ERPO Required Actor Groupings.....	9
	X.4 ERPO Overview .....	10
	X.4.1 Concepts .....	10
75	X.4.2 Use Cases .....	10
	X.4.2.1 Use Case #1: Endoscopy basic report workflow .....	10
	X.4.2.1.1 Endoscopy basic workflow Use Case Description .....	10
	X.4.2.1.2 Endoscopy basic report workflow Process Flow.....	10
	X.5 ERPO Security Considerations .....	11
80	X.6 ERPO Cross Profile Considerations.....	11
	Appendices.....	13
	Appendix A – The relationship between the Implementation Roadmap and the Integration Profile of IHE Endoscopy.....	13
	<b>Volume 2 – Transactions .....</b>	<b>15</b>
85	3.3 Notify Observation Report [Endo-3] .....	15
	3.3.1 Scope .....	15
	3.3.2 Actor Roles.....	15
	3.3.3 Referenced Standards.....	16
	3.3.4 Interaction Diagram.....	16
90	3.3.4.1 MDM/ACK^T02 Original Documentation Notification.....	16
	3.3.4.1.1 Trigger Events .....	16
	3.3.4.1.2 Message Semantics.....	16
	3.3.4.1.2.1 TXA .....	17
	3.3.4.1.2.1.1 TXA filed definitions .....	18
95	3.3.4.1.3 Expected Actions .....	18
	3.3.5 Security Considerations.....	18
	3.6 Notify Endoscopy Status [Endo-6] .....	19

	3.6.1 Scope .....	19
	3.6.2 Actor Roles.....	19
100	3.6.3 Referenced Standards.....	20
	3.6.4 Interaction Diagram.....	20
	3.6.4.1 MDM/ACK^T01 Original Documentation Notification.....	20
	3.6.4.1.1 Trigger Events .....	20
	3.6.4.1.2 Message Semantics.....	20
105	3.6.4.1.3 Expected Actions .....	21
	3.6.4.2 ACK.....	21
	3.6.4.2.1 Trigger Events .....	21
	3.6.4.2.2 Message Semantics.....	21
	3.6.4.2.3 Expected Actions .....	22
110	3.6.5 Security Considerations.....	22
	Appendices.....	23
	Volume 2 Namespace Additions .....	23
	<b>Volume 3 – Content Modules.....</b>	<b>24</b>
	Appendices.....	25
115	Volume 3 Namespace Additions .....	25
	<b>Volume 4 – National Extensions .....</b>	<b>26</b>

## **Introduction to this Supplement**

- 120 ERPO defines specific implementations of established standards to achieve integration goals for endoscopy. Such integration promotes appropriate sharing of medical information to support optimal patient care.

The IHE Endoscopy Integration Profiles rely heavily on, and reference, the transactions defined in those other IHE Technical Framework documents.

## 125 **Open Issues and Questions**

None

## **Closed Issues**

None

## General Introduction

- 130 *Update the following Appendices to the General Introduction as indicated below. Note that these are not appendices to Volume 1.*

### Appendix A - Actor Summary Definitions

*Add the following actors to the IHE Technical Frameworks General Introduction list of Actors:*

Actor	Definition
Order Placer	The actor that places orders or cancels orders on necessity.
Order Filler	The actor that receives and processes (fills) orders. It also receives order cancellations.
Report Creator	The actor that creates endoscopy observation report and send it to Order Placer.

- 135 **Appendix B - Transaction Summary Definitions**

*Add the following transactions to the IHE Technical Frameworks General Introduction list of Transactions:*

Transaction	Definition
Order Endoscopy	The transaction that places endoscopy order.
Notify Patient Arrival	The transaction that that notify the status of patient arrival.
Notify Observation Report	The transaction that provides endoscopy observation report.
Fill Endoscopy Order	The transaction that fills endoscopy order.

## Glossary

- 140 *Add the following glossary terms to the IHE Technical Frameworks General Introduction Glossary:*

None

# Volume 1 – Profiles

## Copyright Licenses

145 *Add the following to the IHE Technical Frameworks General Introduction Copyright section:*

This section is not applicable.

## Domain-specific additions

This section is not applicable.

150 *Add Section X*

## X ERPO Profile

155 The Endoscopy Report and Pathology Order workflow specifies a series of workflows where endoscopy is conducted on the order from the hospital information system located outside of the endoscopy department and the endoscopy report returned to the system.

The OF (Order Filler) receives an order from the Order Placer to administer an endoscopy. This process is defined as EWF. When the endoscopy procedure is over, the OF notifies the OP located in hospital information system located outside of the endoscopy department of the endoscopy observation report to make a pathology order.

160 We also considered returning status of “Endoscopy report creation was done” to OP independently from the status of Endoscopy report by “Notify Observation Report” transaction.

The end period of the Endoscopy procedure is considered when both of Observation Report Notification in this profile and Endoscopy Execution Information Notification in EWF Profile are completed.

## 165 X.1 ERPO Actors, Transactions, and Content Modules

This section defines the actors, transactions, and/or content modules in this profile. General definitions of actors are given in the Technical Frameworks General Introduction Appendix A at [http://www.ihe.net/Technical\\_Frameworks](http://www.ihe.net/Technical_Frameworks).

170 Figure X.1-1 shows the actors directly involved in the ERPO Profile and the relevant transactions between them. If needed for context, other actors that may be indirectly involved due to their participation in other related profiles are shown in dotted lines. Actors which have a mandatory grouping are shown in conjoined boxes.

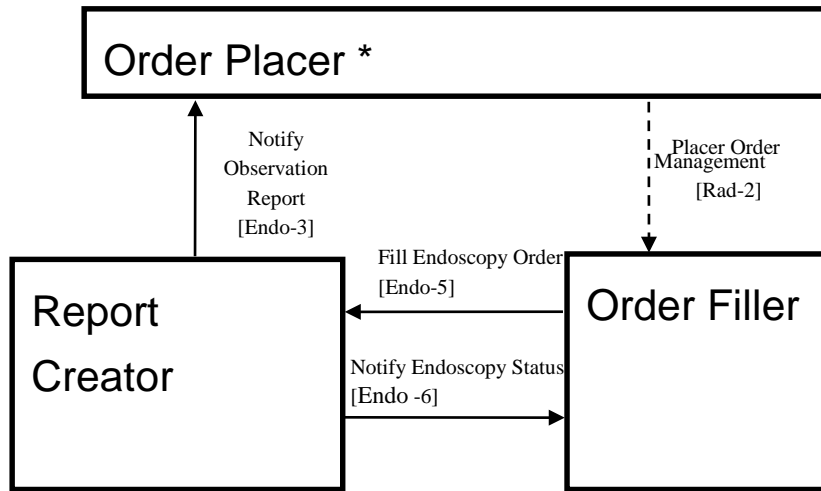

175

**Figure X.1-1: ERPO Actor Diagram**

Note: The Order Placer in this profile has a function to analyze the endoscopy observation report to know if pathology order is necessary. It also takes necessary information from the endoscopy observation report to make a pathology order and places a pathology order.

180

Table X.1-1 lists the transactions for each actor directly involved in the ERPO Profile. To claim compliance with this profile, an actor shall support all required transactions (labeled “R”) and may support the optional transactions (labeled “O”).

**Table X.1-1: ERPO Profile - Actors and Transactions**

Actors	Transactions	Optionality	Section
Order Filler	Fill Endoscopy Order [Endo-5]	C	ENDO-TF 2.4.5
	Notify Endoscopy Status [Endo-6]	C	ENDO-TF 2.4.6
Order Placer	Notify Observation Report [Endo-3]	R	ENDO-TF 2.4.3
Report Creator	Notify Observation Report [Endo -3]	R	ENDO-TF 2.4.3
	Fill Endoscopy Order [Endo-5]	C	ENDO-TF 2.4.5
	Notify Endoscopy Status [Endo-6]	C	ENDO-TF 2.4.6

185

Note: In the table above, the transactions labeled “R” are required. The transactions labeled “C” are conditionally required with the condition of second stage implementation as described in Appendix A.



### X.1.1 Actor Descriptions and Actor Profile Requirements

Most requirements are documented in Transactions (Volume 2) and Content Modules (Volume 3). This section documents any additional requirements on profile's actors.

### 190 X.2 ERPO Actor Options

Options that may be selected for each actor in this profile, if any, are listed in the Table X.2-1. Dependencies between options when applicable are specified in notes.

**Table X.2-1: ERPO - Actors and Options**

Actor	Option Name	Reference
Order Placer	No options defined	--
Order Filler	No options defined	--
Report Creator	No options defined	--

195

### X.3 ERPO Required Actor Groupings

An actor from this profile (column 1) shall implement all of the required transactions and/or content modules in this profile *in addition to* all of the transactions required for the grouped actor (column 2).

200 If this is a content profile, and actors from this profile are grouped with actors from a workflow or transport profile, the Content Bindings reference column references any specifications for mapping data from the content module into data elements from the workflow or transport transactions.

205 In some cases, required groupings are defined as at least one of an enumerated set of possible actors; this is designated by merging column one into a single cell spanning multiple potential grouped actors. Notes are used to highlight this situation.

Section X.5 describes some optional groupings that may be of interest for security considerations and Section X.6 describes some optional groupings in other related profiles.

210 **Table X.3-1: ERPO - Required Actor Groupings**

ERPO Actor	Actor to be grouped with	Reference	Content Bindings Reference
Order Placer	None	--	--
Order Filler	None	--	--
Report Creator	None	--	--

## **X.4 ERPO Overview**

### **X.4.1 Concepts**

This section is not applicable.

### **X.4.2 Use Cases**

#### **215 X.4.2.1 Use Case #1: Endoscopy basic report workflow**

The use case represents the basic report workflow. It includes the information process of endoscopy order, clinical observation report notification and actors' status information.

##### **X.4.2.1.1 Endoscopy basic report workflow Use Case Description**

220 The following workflow shows the process of an endoscopy examination procedure that includes ordering, endoscopy examination and finally submits observation report. Endoscopy is scheduled on the order that Order Placer generates and the information that is required to make a pathology order is sent from Report Creator to Order Placer on the completion of the observation report. Upon the completion of the observation report, the Report Creator provides the observation report to the Order Placer. Then the Order Filler identifies the Exam End when it receives the  
225 task completion notification from the Report Creator.

##### **X.4.2.1.2 Endoscopy basic report workflow Process Flow**

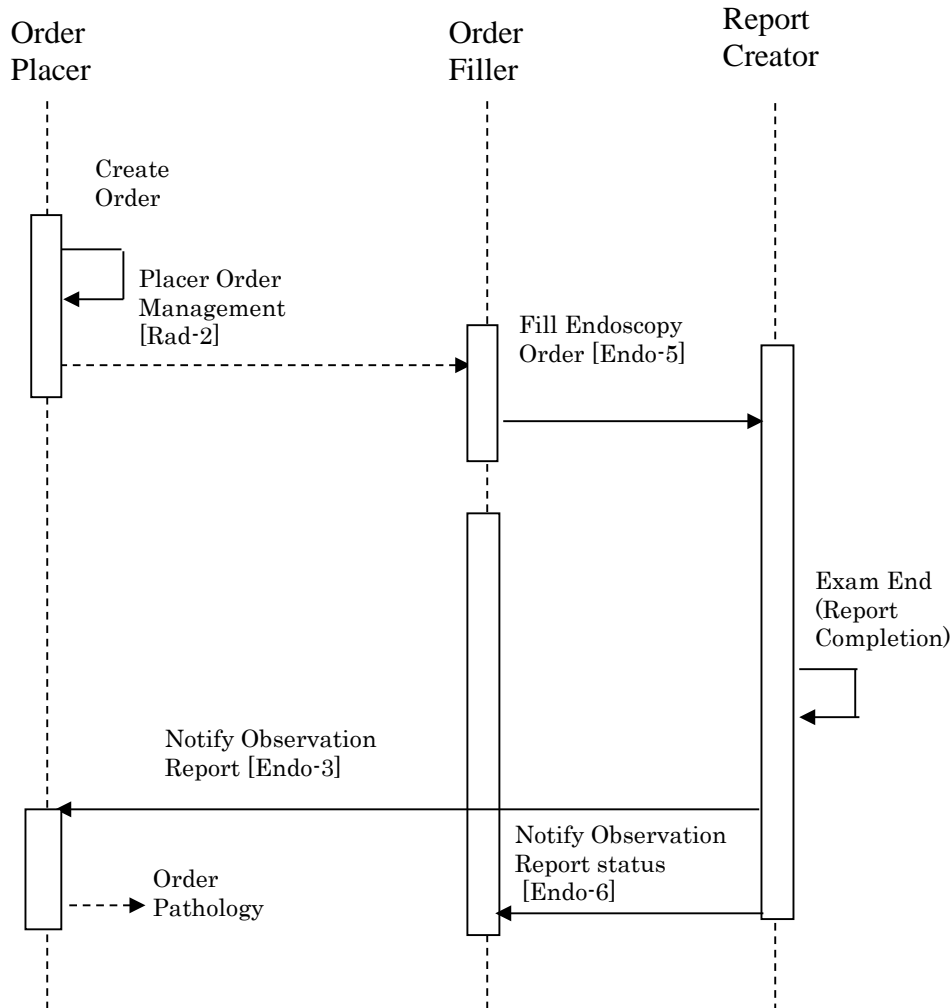

Figure X.4.2.1.2-1: Basic Process Flow in ERPO Profile

230

## X.5 ERPO Security Considerations

The security considerations for a content module are dependent upon the security provisions defined by the grouped actor(s).

## X.6 ERPO Cross Profile Considerations

235 EWF- Endoscopy Ordering Workflow

Order Placer and Order Filler in Endoscopy Ordering Workflow have to be grouped with an Order Placer and an Order Filler in order to manage ordering information.

PAM – Patient Administration Management

- 240 Patient Demographics Consumer and Patient Encounter Consumer in Patient Administration Management could be grouped with an Order Placer and an Order Filler in order to manage patient information.

PDQ – Patient Demographics Query

- 245 Patient Demographics Consumer and Patient Encounter Consumer in Patient Demographics Query could be grouped with an Order Placer and an Order Filler in order to manage patient information.

CT – Constant Time

- 250 Time Client in Constant Time could be grouped with an Order Placer, an Order Filler and Report Creator in order to synchronize the entire system.

## Appendices

255

### Appendix A – The relationship between the Implementation Roadmap and the Integration Profile of IHE Endoscopy.

260 The Integration Profile based on the originally-defined Endoscopy Workflow included every necessary process in one integration profile. Ultimately, the goal of the current Integration Profile is the same as that of the original profile.

265 However, since there are cases where the implementation progresses in steps the Profile needed to reflect these progressive aspects as well as implementation of the system as a whole. The order of priority was difficult to determine when the Integration Profile was defined as one large profile covering entire workflow and when each of the component transactions were regarded as being required.

Therefore, we have decided to present a Roadmap of implementation, in which the Integration Profile was divided. The Implementation Roadmap is a three-stage process as shown below.

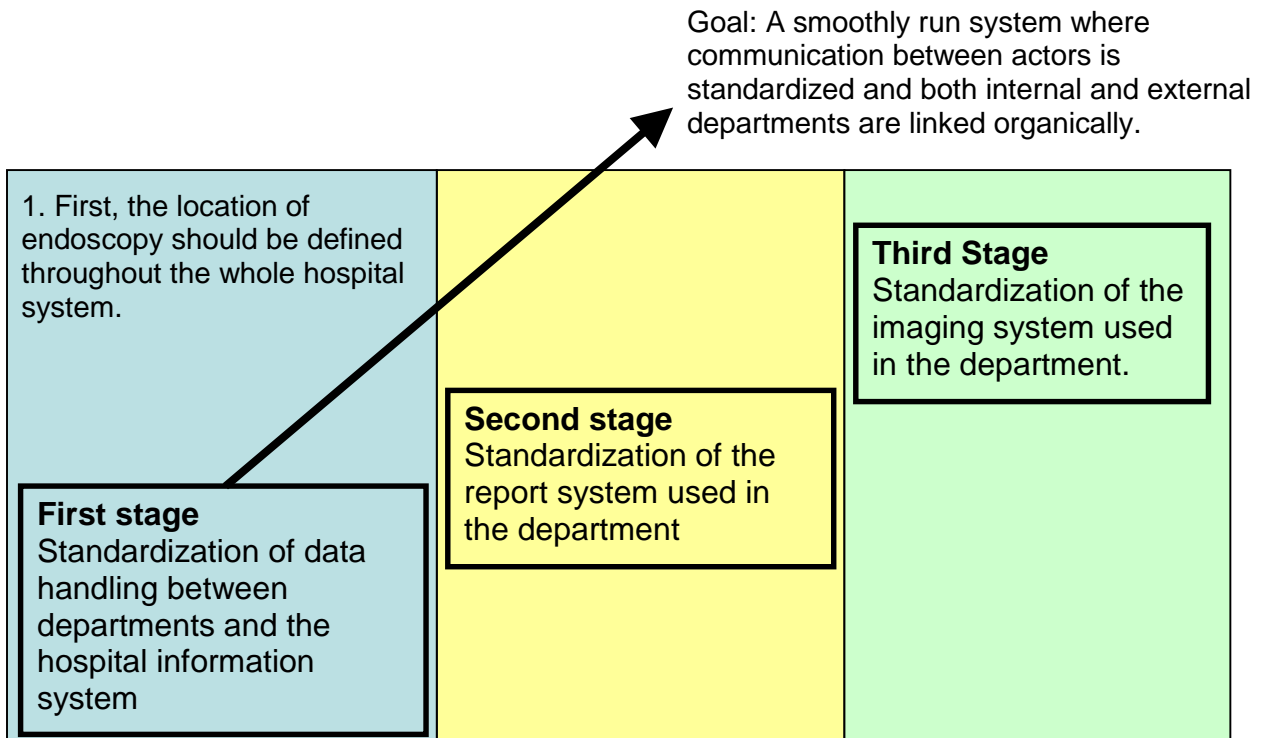

270

Figure A-1: Implementation Roadmap

275 In the first stage, the workflow focusing on data handling between department system and the hospital information system was defined. In order for a smooth and manageable introduction of the IT system throughout the whole hospital, priority should be given to general data handling, such as how orders are treated and how information from departments is received, rather than focusing on department specific requirement. The required transactions defined in the Endoscopy Workflow (EWF) are the Integral Profiles which correspond to this stage.

280 In the second stage, the workflow focusing on the data handling of procedure reports within departments was defined. An endoscopy is completed when the report is filled in. Considering the total flow comprising the whole endoscopy procedure, the report workflow is, after the workflow between departments and the hospital information system, most important. Endoscopy Report and Pathology Order (ERPO) represents this stage where those transactions are defined as conditional.

285 The endoscopy procedure includes steps where an order is received, the procedure carried out and an observation report generated. These steps are considered as a workflow since once a reporting procedure has been completed, the workflow is considered as completed. However, the reporting part is defined as conditional because the report is considered as the second stage in the above Implementation Roadmap.

290 Finally, the third stage defines a workflow focusing on the image information communication which is acquired during the endoscopic procedure. The Endoscopy Image Archiving (EIA) is made up of the Integration Profiles which correspond to this stage.

## Volume 2 – Transactions

Add Section 3.3

### 3.3 Notify Observation Report [Endo-3]

295 During endoscopy examination, when physician performs biopsy, pathology order should be necessary. This transaction specifies a procedure to send an endoscopy report (including all necessary information for the pathology order) from the department system to the HIS, to trigger the provision of information for the HIS to perform the pathology order.

#### 3.3.1 Scope

300 This transaction used by the Report to provide the observation report to the Pathology Order Trigger Receiver. (Pathology Order Trigger Receiver is expected to analyze the report to find if pathology order is necessary and notify the result to the order placer. However the expectation is out of scope of this document.)

#### 3.3.2 Actor Roles

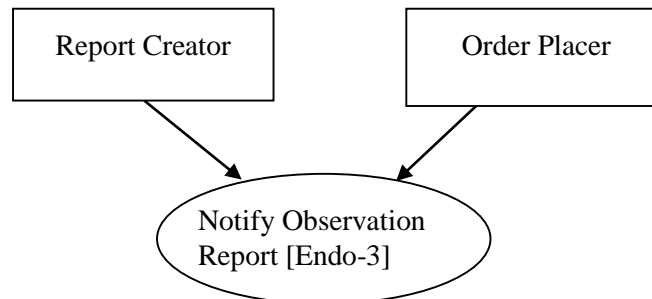

305

Figure 3.3.2-1: Use Case Diagram

Table 3.3.2-1: Actor Roles

<b>Actor:</b>	Report Creator
<b>Role:</b>	Provide the observation report to the Order Placer.
<b>Actor:</b>	Order Placer
<b>Role:</b>	Receive the observation report that report issued, analyze the report so that Order Placer places relating order (e.g., pathology order).

310 Transaction text specifies behavior for each role. The behavior of specific actors may also be specified when it goes beyond that of the general role.

### 3.3.3 Referenced Standards

HL7® Ver2.5 Chapter 9.5.2

### 3.3.4 Interaction Diagram

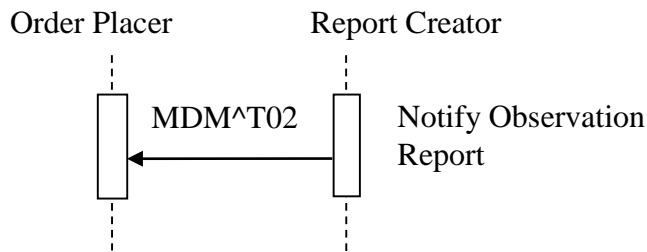

315

**Figure 3.3.4-1: Use Case Diagram**

Note: Simple acknowledgment messages are omitted from the diagrams for brevity.

#### 3.3.4.1 MDM/ACK^T02 Original Documentation Notification

320 The original documentation notification message (MDM) is used for providing the observation report. The segment and syntax rules in this case are as follows.

##### 3.3.4.1.1 Trigger Events

T02: Original documentation notification

##### 3.3.4.1.2 Message Semantics

MDM^T02^MDM_T02	Original Document Notification & Content	Status	Chapter
MSH	Message Header		2
EVN	Event Type	B, v2.5	3
PID	Patient Identification		3
PV1	Patient Visit		3
[{	--- COMMON_ORDER begin		
ORC	Common order segment		4
[{	--- TIMING begin		
TQ1	Timing/Quantity		4



MDM^T02^MDM_T02	Original Document Notification & Content	Status	Chapter
[{TQ2}]	Timing/Quantity Order Sequence		4
}]	--- TIMING end		
OBR	Observation request segment		4
[{ NTE }]	Notes and comments about the observation (OBR)		2
	--- COMMON_ORDER end		
TXA	Document Notification		9
{			
OBX	Observation/Result (one or more required)		9
[{ NTE }]	Notes and comments about the observation (OBX)		2
}			

325

ACK^T02^ACK	General Acknowledgment	Status	Chapter
MSH	Message Header		2
MSA	Message Acknowledgment		2
[{ ERR }]	Error Information		2

Note: [ ] indicates optional items, { } indicates repeatable items.

- The output unit that confirms the arrival requires a MSH at the head.
- PID and PV1 are required.

330

- OBX is required to store document files complying with HL7® CDA® R2.

### 3.3.4.1.2.1 TXA

335

The TXA segment contains information specific to a transcribed document but does not include the text of the document. The message is created as a result of a document status change. This information updates other healthcare systems and allows them to identify reports that are available in the transcription system. By maintaining the TXA message information in these systems, the information is available when constructing queries to the transcription system requesting the full document text.

**Table 3.3.4.1.2.1-1: HL7® Attribute Table - TXA – Transcription Document Header**

SEQ	LEN	DT	OPT	RP/#	TBL #	ITEM#	ELEMENT NAME
1	4	SI	R			00914	Set ID- TXA
2	30	IS	R		0270	00915	Document Type
3	2	ID	C		0191	00916	Document Content Presentation
4	26	TS	O			00917	Activity Date/Time
5	250	XC N	C	Y		00918	Primary Activity Provider Code/Name
6	26	TS	O			00919	Origination Date/Time
7	26	TS	C			00920	Transcription Date/Time
8	26	TS	O	Y		00921	Edit Date/Time
9	250	XC N	O	Y		00922	Originator Code/Name
10	250	XC N	O	Y		00923	Assigned Document Authenticator
11	250	XC N	C	Y		00924	Transcriptionist Code/Name
12	30	EI	R			00925	Unique Document Number
13	30	EI	C			00926	Parent Document Number
14	22	EI	O	Y		00216	Placer Order Number
15	22	EI	O			00217	Filler Order Number
16	30	ST	O			00927	Unique Document File Name
17	2	ID	R		0271	00928	Document Completion Status
18	2	ID	O		0272	00929	Document Confidentiality Status
19	2	ID	O		0273	00930	Document Availability Status
20	2	ID	O		0275	00932	Document Storage Status
21	30	ST	C			00933	Document Change Reason
22	250	PPN	C	Y		00934	Authentication Person, Time Stamp
23	250	XC N	O	Y		00935	Distributed Copies (Code and Name of Recipients)

340

### 3.3.4.1.2.1.1 TXA filed definitions

See HL7® Ver2.5 Section 9.6.1 “TXA-Transcription Document Header Segment”.

### 3.3.4.1.3 Expected Actions

This section is not applicable.

### 345 3.3.5 Security Considerations

None

Add Section 3.6

350 **3.6 Notify Endoscopy Status [Endo-6]**

This transaction enables the Endoscopy Report Creator and/or Execution Information Creator to send a message to notify the OF of the completion of the endoscopy observation report and/or completion of providing performed information. Endoscopy is considered completed upon the completion of endoscopy report and the completion of performed information notification. Thus, 355 OF in receiving the message is acknowledging that the endoscopy has been completed.

**3.6.1 Scope**

This section is not applicable.

**3.6.2 Actor Roles**

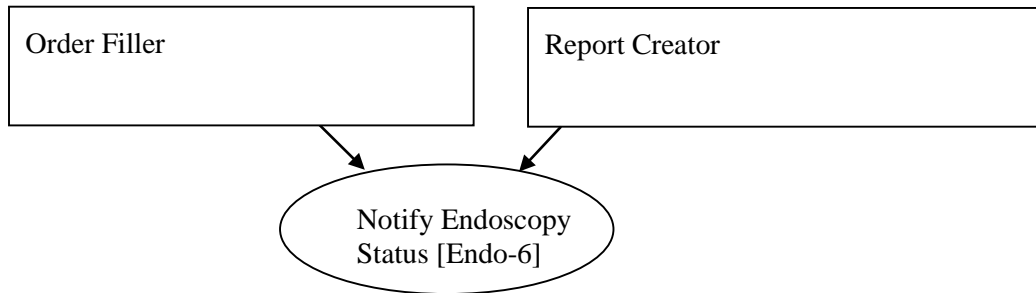

360

**Figure 3.6.2-1: Use Case Diagram**

**Table 3.6.2-1: Actor Roles**

<b>Actor:</b>	Order Filler
<b>Role:</b>	Receive endoscopy status information that Report Creator provided.
<b>Actor:</b>	Report Creator
<b>Role:</b>	Provide endoscopy status information.

365

Transaction text specifies behavior for each role. The behavior of specific actors may also be specified when it goes beyond that of the general role.

### 3.6.3 Referenced Standards

HL7® Ver2.5 Chapter 9.5.1

### 370 3.6.4 Interaction Diagram

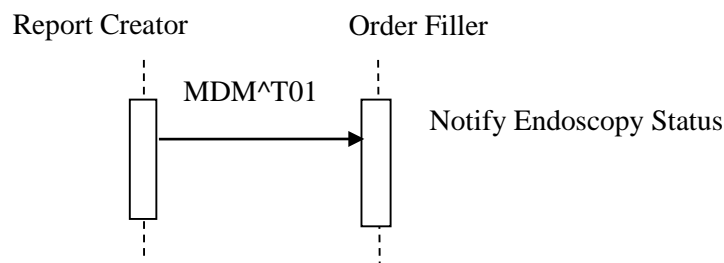

**Figure 3.6.4-1: Use Case Diagram**

Note: Simple acknowledgment messages are omitted from the diagrams for brevity.

#### 3.6.4.1 MDM/ACK^T01 Original Documentation Notification

375 The original documentation notification (MDM) is used for notifying the status of the endoscopy observation report. The event type is ‘T01’.

##### 3.6.4.1.1 Trigger Events

T01-A report notification message event is an event that notifies an endoscopy observation report status.

### 380 3.6.4.1.2 Message Semantics

MDM^T01^MDM_T01	Original Document Notification & Content	Status	Chapter
MSH	Message Header		2
EVN	Event Type	B, v2.5	3
PID	Patient Identification		3
PV1	Patient Visit		3
[{	--- COMMON_ORDER begin		
ORC	Common order segment		4

MDM^T01^MDM_T01	Original Document Notification & Content	Status	Chapter
[ {	--- TIMING begin		
TQ1	Timing/Quantity		4
[ {TQ2} ]	Timing/Quantity Order Sequence		4
}]	--- TIMING end		
OBR	Observation request segment		4
[ { NTE } ]	Notes and comments about the observation (OBR)		2
	--- COMMON_ORDER end		
TXA	Document Notification		9

Note: [ ] indicates optional items, { } indicates repeatable items.

- 385
- The output unit that confirms the arrival requires a MSH at the head.
  - PID and PV1 are required.

### 3.6.4.1.3 Expected Actions

This section is not applicable.

### 3.6.4.2 ACK

- 390 **3.6.4.2.1 Trigger Events**

This section is not applicable.

### 3.6.4.2.2 Message Semantics

ACK^T01^ACK	General Acknowledgment	Status	Chapter
MSH	Message Header		2
MSA	Message Acknowledgment		2
[ { ERR } ]	Error Information		2 <sup>395</sup>

Note: [ ] indicates optional items, { } indicates repeatable items.

**3.6.4.2.3 Expected Actions**

400 This section is not applicable.

**3.6.5 Security Considerations**

This section is not applicable.

## Appendices

None

405

### **Volume 2 Namespace Additions**

*Add the following terms to the IHE General Introduction Appendix G:*

None

410

## Volume 3 – Content Modules

This section is not applicable.

415



# Appendices

None

## **Volume 3 Namespace Additions**

420 None

425

## **Volume 4 – National Extensions**

This section is not applicable.