

Integrating the Healthcare Enterprise



5

**IHE Cardiology
Technical Framework Supplement**

10

**Resting ECG Workflow
(REWF)**

15

Trial Implementation

20 Date: August 29, 2013
Author: IHE Cardiology Technical Committee
Email: cardio@ihe.net

Foreword

25 This is a supplement to the IHE Cardiology Technical Framework 5.0. Each supplement undergoes a process of public comment and trial implementation before being incorporated into the volumes of the Technical Frameworks.

This supplement is submitted for trial implementation as of August 29, 2013 and may be available for testing at subsequent IHE Connectathons. The supplement may be amended based on the results of testing. Following successful testing it will be incorporated into the Cardiology Technical Framework. Comments are invited and may be submitted at http://www.ihe.net/Cardiology_Public_Comments.

30 This supplement describes changes to the existing technical framework documents and where indicated amends text by addition (**bold underline**) or removal (~~**bold strikethrough**~~), as well as addition of large new sections introduced by editor’s instructions to “add new text” or similar, which for readability are not bolded or underlined.

35 “Boxed” instructions like the sample below indicate to the Volume Editor how to integrate the relevant section(s) into the relevant Technical Framework volume:

40

<i>Replace section X.X by the following:</i>
--

General information about IHE can be found at: www.ihe.net.

Information about the IHE Cardiology domain can be found at: http://www.ihe.net/IHE_Domains.

45 Information about the organization of IHE Technical Frameworks and Supplements and the process used to create them can be found at: http://www.ihe.net/IHE_Process and <http://www.ihe.net/Profiles>.

The current version of the IHE Cardiology Technical Framework can be found at: http://www.ihe.net/Technical_Frameworks.

50

CONTENTS

55	Introduction.....	4
	Profile Abstract	4
	Open Issues and Questions	4
	Closed Issues	4
	Volume 1 – Integration Profiles.....	14
60	1.7 History of Annual Changes	14
	1.9 Copyright Permission.....	14
	1.10 Patent Disclaimer	14
	2.1 Dependencies among Integration Profiles	15
	2.2.7 Resting ECG Workflow (REWF)	15
65	2.3 Actor Descriptions	15
	2.4 Transaction Descriptions.....	16
9	Resting ECG Workflow (REWF)	17
	9.1 Actors/Transactions.....	17
	9.1.1 Required and Suggested Actor Groupings	21
70	9.2 Resting ECG Workflow Integration Profile Options	21
	9.3 Resting ECG Workflow Process Flow.....	22
	9.3.1 Normal Priority, Scheduled ECGs	22
	9.3.2 Urgent ECG, Unidentified Patient	26
	9.3.3 Scheduled ECG While Offline.....	29
75	9.3.4 Other use cases not completely covered by REWF	31
	9.4 Resting ECG Workflow Security Considerations.....	34
	Volume 2 – Transactions.....	35
	4.2 Modality Images/Evidence Stored [CARD-2]	35
	4.2.9 Resting ECG Workflow Profile Behavior.....	35
80	4.4 Retrieve Images/Evidence [CARD-4].....	37
	4.4.6 Scope within the Resting ECG Workflow Profile	37
	4.7 Encapsulated Report Submission [CARD-7].....	39
	4.7.x Resting ECG Workflow Profile Behavior.....	40
	4.12 Query Enhanced Modality Worklist [CARD-12]	41
85	4.12.1 Query Scheduled MWL Message – Enhanced Message Semantics	42
	4.13 Query Cardiology Images/ Evidence [CARD-13]	47
	4.13.1 Use Case Roles	47
	4.13.2 Interaction Diagram.....	48
	4.13.3 Message Semantics – Query Images – Resting ECG Workflow Profile Query	
90	Requirements	48
	Appendix A: Clarification on MPPS for Intermittently Connected Modality.....	49

Introduction

- 95 This Supplement introduces a new Profile to the IHE Cardiology Technical Framework, with the overall design in Volume 1 and specific transactions in Volume 2. This Profile is built using transactions specified in the existing IHE Cardiology Technical Framework, which are extended to include specification for handling electrocardiography (ECG) information. This Profile also relies heavily on transactions specified in the existing IHE Radiology and IHE IT Infrastructure Technical Frameworks, although no changes are introduced to those documents.
- 100

Profile Abstract

- A resting ECG is the most widely prescribed diagnostic cardiac test. Electrocardiographs, unlike other cardiology modality devices, have traditionally used proprietary communication protocols making device interoperability and clinical workflow very difficult. The Resting ECG Workflow (REWF) integration profile specifies actors and transactions that allow users to register a patient, order the test, perform the test (acquiring the waveforms), and interpret the test results (reporting) in an interoperable way. The Resting ECG Workflow profile will also handle unordered tests, urgent cases, and ECGs acquired in both hospital and office settings.
- 105

Open Issues and Questions

110

#	Issue/ (Answer)
---	-----------------

(none)

Closed Issues

#	Issue/ (Answer)
---	-----------------

- 1 How do hospitals use resting ECG tests to initiate their STEMI protocols? Do all hospitals use the same criteria? Do they want the devices to call attention to ECGs that meet the criteria?

The committee agreed that standardizing the communication of critical criteria is outside the scope for now. The criteria may be ECG algorithm dependent, and each hospital potentially has its own. This feature is left to the device manufacturers to implement outside this profile.

- 2 What can be done to encourage vendors with classic ECG management systems to participate in this profile while also allowing classic PACS and CVIS systems to participate too?

This profile will allow the grouping of several actors into an “Integrated ECG Manager” meta actor. If a product claims the Integrated ECG Manager, it will not be required to support the internal transaction.

- 3 No transactions are specified between the Report Creator and DSS/OF. Should this profile require the grouping or should it define the necessary transactions?

The current approach is to require the grouping between the Report Creator and the DSS/OF Actor. DSS/OF will receive events and have business logic to initiate the creation and communication of the reports at the appropriate times.

- 4 Does REWF need a PPS Manager?

Yes, to keep consistent with the existing workflow profiles for Cath, Echo, and others. PPS Manager will be grouped with DSS/OF or Image Manager. Products claiming DSS/OF and Image Manager are required to forward the PPS messages if configured to do so. They are also required not to forward messages if configured to do so.

- 5 Should a PDQ Patient Demographics Supplier actor be required to group with either the ADT or DSS/OF actor? If not, should REWF specify how the Patient Demographics Supplier gets registration information?

It is not necessary for REWF to reference or be dependent on the Patient Demographics Query (PDQ) profile from ITI. The actors from the PDQ profile can be implemented by products participating in REWF. For example, products claiming the Acquisition Modality actor in this profile may also choose to be a Patient Demographics Consumer from PDQ. Likewise, products claiming ADT may also choose to be a Patient Demographics Supplier from PDQ. How information flows to the Patient Demographics Supplier in PDQ is beyond the scope of this profile.

- 6 How much of the ECG reporting workflow should be covered in this profile?

Reporting is very important for resting ECG workflow. This profile specifies actors and transactions for retrieving and storing the discrete waveforms, measurements, and interpretations. It shows how electrocardiographs store the preliminary measurements and interpretations, and it shows how cardiologists will store their final measurements and interpretations. It also specifies how reports will be created and sent to the enterprise.

However, reporting workflow management is not covered. This is a common deficiency in many other IHE workflow profiles, and ECG workflow management should be consistent with the others. There is simply not enough time to specify how reporting workflow management should work for ECG and other modalities. Radiology made an attempt with the Reporting Workflow (RWF) profile, but its use of DICOM's general-purpose procedure step was not well adopted. DICOM has been working on the unified-procedure step (UPS), but the cardiology committee doesn't have sufficient time to consider it and make it part of this profile.

The cardiology committee agrees that reporting workflow management is important, and it plans to address this in a future year.

- 7 Should the Acquisition Modality have a required grouping with the PDQ Patient

Demographics Consumer? Won't all electrocardiographs potentially be used in environments without orders?

Let device manufacturers decide if their electrocardiographs will claim Patient Demographics Consumer from PDQ. Requiring the HL7 transactions is new for devices, and may hinder the adoption of this profile. Besides, all devices must still handle the case of unregistered patients, or when they are not connected to the network. In these cases, the demographics must be keyed by hand.

Also see Issue #5.

- 8 How should the ECG waveforms, automatic measurements, and interpretation from the Acquisition Modality be stored? There are 3 different DICOM ECG waveform objects, and the 12-lead ECG Waveform object limits the number of channels to 13. Some devices create ECGs with 15 or more leads.

The 3 different ECG waveform objects were specified over 10 years ago when there were still concerns over memory and network bandwidth. The 12-lead ECG Waveform object intentionally limited the number and duration of the waveforms so the objects would be guaranteed to be small.

The General ECG Waveform object has all the features of the 12-lead ECG Waveform object except it allows up to 24 channels of arbitrary duration. This profile shall require the use of the Performed Protocol Code Sequence (0040,0260) so downstream actors know it is a resting ECG instead of an arbitrary rhythm strip from a monitoring session or other type of test. The SNOMED code P2-3120A "12-lead ECG" shall be used to indicate it was a resting ECG. The coding scheme is referenced as "SRT".

Most clinicians mean "resting ECG" when they use the term "12-lead ECG". 12-leads have traditionally been used for diagnostics while reduced lead sets have been used for rhythm monitoring. Harry Solomon will submit a request to SNOMED to create a "Resting ECG" alias for "12-lead ECG".

The General ECG Waveform object has an Annotation section. It is limited to Context ID 3335 which includes codes for waveform features, like P-onset, T-offset, etc. It does not support any measurements or interpretations. Therefore, the measurements and interpretations, regardless if they are created by the device or a cardiologist, will be stored in a separate SR object. Resting ECG will use the ECG Report template TID 3700.

- 9 Is the information accessible to the Report Creator from the MPPS and Instance Availability Notification Transactions (via the required grouping with the DSS/OF) adequate for generating worklists with all the information necessary to enable worklist queries to satisfy the use cases (e.g., location of ECG acquisition, status (= Not reported), date/ time of acquisition, physician assigned to read, etc.)?

Reporting workflow management will be addressed in a future year. Also see issue #6.

- 10 ECG techs sometimes take multiple ECGs just to get a clean one. Although they should only store the clean one they want to keep, they sometimes store multiple ECGs. In this

case, it will be the responsibility of the downstream technicians to determine which ECG to keep and which ones to throw away. Should all the ECGs acquired from the same scheduled procedure step be “matched” to that step? Should they all have the same Study Instance UID and Accession Number?

Multiple ECGs taken as part of same Study “to get a good one” will all go into the same Series of the same Study. Acquisition Modalities should have a way to let the technician indicate when she’s starting a new study on the same patient. Only one MWL workitem and MPPS per Study.

- 11 Which transactions should be associated with ATNA Auditing?

Save for a future year.

- 12 How to specify role-based access to reporting workitems, stored images/evidence, and permission to create reports.

Save for a future year.

- 13 Should we include an option for Clinical Trial support? Claiming the option means device and management systems can populate and handle additional information about trials, like subject ID, protocol name, sponsor, time point codes, etc.

A Clinical Trial Option was considered, but will be deferred to a future year. The Option could probably be claimed by the Report Creator and the Integrated ECG Manager. If the option was supported, the Report Creator (or Integrated ECG Manager) would be required to send a "Submit Annotated ECG" transaction to a Trial ECG Consumer actor. The Report Creator (or Integrated ECG Manager) would also be required to associate clinical trial identifiers with the ECG waveform, measurement and interpretation information it exports in the "Submit Annotated ECG" transaction. How it performs this "association" may be beyond the scope of the profile (e.g., values for trial IDs and other trial info could be 'hand-entered' at the Report Creator (or Integrated ECG Manager), or the values for trial IDs and trial info could be conveyed using other attributes that are part of the normal Resting ECG acquisition workflow). The key would be that the structure of the messages (transactions) used to transmit information in the "clinical resting ECG workflow" cases would be identical to the structure of the messages (transactions) in the "clinical trial/ pharma workflow" (From ADT --> DSS/OF --> Acquisition Modality --> Image Manager/Archive --> Report Manager or Image Display.

The advantages to this approach could be:

- 1. It eliminates the need for DSS/OF and Acquisition Modality Actors (systems) to have different "modes" (normal workflow vs. clinical trial workflow) that would be needed to allow those system to behave differently depending on which type of workflow was being performed.*
- 2. There are some current standards gaps in conveying clinical trial information between certain systems/ actors. Most notably, the DICOM MWL service between DSS/OF and Acquisition Modality) does not currently allow the inclusion of clinical trial attributes.*

Using the approach outlined above could make this a non-issue.

3. This approach supports the most common current practices in ECG clinical trial workflow administration.

4. May not require additional transaction specifications to be written beyond what was already identified during the face-to-face at Heart House in April, 2010.

- 14 Can reporting workitems include a set of clinical trial protocol measurements to be made? Should Image Display and Evidence Creator (parts of a reporting workstation) know what measurements need to be made based on the trial and protocol information in the optional Clinical Trial modules in the General ECG?

Reporting workitems, part of reporting workflow management, will be addressed in a future year. The reporting workstation could possibly use information in the Clinical Trial modules in the General ECG Waveform object; however use of the Clinical Trial module is not addressed in this profile. Clinical Trial workflow will be address in a future year. How the reporting workstation knows which measurements to make is outside the scope of the profile for this year.

- 15 Electrocardiographs create, display, and print preliminary reports at the point of acquisition. These preliminary reports are especially useful in the emergency department where snap decisions may need to be made. Some clinical history can be relevant when the ECG is interpreted, like:

- Current medications
- Current diagnosis
- Cardiac history

The DICOM Modality Worklist does not support this information. Can the information be requested by the acquisition device, like through PDQ?

This would require significant additional profiling work, so it will be deferred to another year. The additional information could possibly be put into the Patient Medical section of the MWL as an XML structure from the XDS-MS: Problems, Medications, and Allergies.

- 16 RAD-5, Query Modality Worklist broad query has the following matching attributes:

- Scheduled Procedure Step Start Date
- Modality
- Scheduled Station AE Title

ECG MWL queries may benefit from supporting these additional matching attributes:

- Requested Procedure Code Sequence: this would allow the selection of resting ECG work items without getting stress, Holter, and other ECG procedure requests.
- Scheduled Procedure Step Location: this would allow the selection of work items scheduled for certain areas of the hospital.
- Scheduled Procedure Step Start Time: this would allow the selection of work

items that are scheduled for the next few hours. There is no need to receive work items that are scheduled for more than a few hours into the future.

- **Scheduled Station Name:** this would allow the selection of work items scheduled for the particular station name. This may be redundant with Scheduled Station AE Title.
- **Institution Name:** this would allow the selection of work items for a particular institution which is important in situations where MWL SCP supports multiple institutions.

Make a new CARD-specific “Query Enhanced Modality Worklist” that supports the additional matching field:

- *Scheduled Procedure Step Location (with wildcards)*

Although the other information is important, the Acquisition Modality can do additional filtering with the returned information before it presents the list to the user.

- 17 RAD-5, Query Modality Worklist patient-directed query has the following matching attributes:

- Patient Name
- Patient ID
- Accession Number
- Requested Procedure ID

ECG MWL queries may benefit from supporting these additional matching attributes:

- **Modality:** there’s no need to receive work items for any other modality than ECG.
- **Admission ID:** patients are often identified by their admission ID rather than their permanent MRN. These are often on patient ID bracelets in addition to, or instead of the MRN.
- **DOB:** patients are often identified by name and DOB.
- **Sex:** patients are identified by sex.

Make a new CARD-specific “Query Enhanced Modality Worklist” that supports the additional matching field:

- *Admission ID*

The other information is important, but the Acquisition Modality can do additional filtering with the returned information.

- 18 This profile submits reports through DRPT as PDFs. Typically the HIS/EMR systems also want to have a few discrete results like the global measurements and interpretation statements. Today, ECG management systems send this information out in OBX segments inside ORU and MDM messages. We need to specify how to communicate the discrete ECG results in DRPT.

Specify in the DRPT profile how to use optional OBX segments in DPRT to convey the discrete ECG results.

- 19 Traditional IHE scheduled workflow requires electronic orders for the procedures. In many places outside the US, like Canada and Europe, orders are not placed for ECGs. However, there will be “care plans”, “protocols”, etc. that imply orders. Is it OK for this profile to require orders, whether they are automatically or manually placed/scheduled?

Set “Issuer of Patient ID” in MPPS Complete message. This tells DSS/OF if patient demographics have already been reconciled with the ADT. DSS/OF must automatically create the identifiers required for results export (OBR-2, OBR-3).

- 20 For PC-ECG devices embedded inside office EMRs, how can the PC-ECG software get the command to “perform new exam on this patient”?

Should the IHE profile for patient-synchronized-applications be used to share the context from EMR? Then the PC-ECG can initiate a PDQ to query for the demographics it needs.

Most host applications, the EMR in this case, can be configured to launch other applications by configuring a command line (for an EXE) or a URL (for a web-based application). When the clinician clicks the “New ECG” button in the EMR, the EMR will automatically place and schedule an ECG order for the AE Title of the PC-ECG that’s on the same workstation. When the PC-ECG application starts, it will automatically perform a Broad Query MWL for the Scheduled AE Title. The DSS/OF will return the single work item just ordered/scheduled for that exam room. If for some reason the DSS/OF returns multiple workitems, the PC-ECG Acquisition Modality would be expected to present the user with a list so she can select the correct item.

- 21 Minimum information for interpretation statements:

- Statement text and manufacturer-specific code
- 0 or more reason statements with a manufacturer-specific codes for each reason

Current SR templates for interpretation statements don’t fully support this. There is a way to get the statement (TID 3717 “Clinical Interpretation”) and the manufacturer-specific code (TID 3718 “Statement”). It is not clear how to include multiple reason statements and codes that provide support for the statement.

Submit CP IHE-CARDIO-1 to extend 3717 to include reasons.

- 22 SR template TID 3713 contains the basic global measurements. Some manufacturers have additional measurements such as:

- Average RR Interval

- Average PP Interval
- Beat Count?
- PVC Count?

CP 729 references all IEEE-11073 MDC codes.

Submit CP IHE-CARDIO-1 to remove the mandatory use of SCP codes in 3713.

- *CP will address all resting ECG needs in TID 3700 and sub templates.*
- *Extend 3717 to include reasons.*
- *Remove the mandatory use of SCP codes in 3713.*
- *Add other global measurements (CID's).*

- 23 DICOM 12-lead ECG Waveform object limits number of channels to 13. Some ECG manufacturers create resting ECGs with more leads.

Use General ECG objects instead. DICOM tag Performed Protocol Code Sequence (0040,0260) shall use SNOMED code P2-3120A for “12-lead ECG”. Coding scheme is SRT (OIDan 2.16.840.999.202.375.6000.202.375.6671).

- 24 Image Archive needs “Intermittently Connected Modality Option” for queuing storage commitment responses. See Echo profile.

OK.

- 25 Appendix A in Volume 2 needs to be update to include a reference to RAD-21 for intermittently connected Evidence Creator.

OK.

- 26 “Submit Annotated ECG” will be a file export using the HL7 V3.

Clinical trial workflow has been deferred to a future year.

- 28 An Image Display built for resting ECGs may not be able to handle really large objects with 24 hours of waveforms. It will want to ignore all the General ECG objects that are not resting ECGs. There must be a way for the Image Display actor to get the Performed Protocol Code Sequence that specifies the object is a resting ECG. Does the Query Images transaction return this information?

Taken care of by modifying CARD-2 and adding new query transaction.

- 29 What does it mean for one profile to be “dependent” on another profile? Doesn’t REWF simply reusing existing actors and transactions that appear in other profiles to achieve its goals? Isn’t it enough to name the actors and transactions, regardless of which other profiles they come from? Is REWF “dependent” on Consistent Time? Is it “dependent” on Scheduled Workflow? Displayable Reports? Patient Demographics Query? Naming the transactions, like “ITI-1” should be enough without having to declare a “dependency”. Otherwise, REWF has to declare dependencies on all the other profiles that use all the existing transactions it is also using, right?

On the other hand, naming related profiles may be a good idea to help reviewers and implementers understand the profile in question. REWF is related to many other profiles, like SWF, PDQ, CT, DRPT, ECG, etc.

A useful page on the IHE Wiki that describes a number of IHE Design Principles and Conventions (including Profile dependency, actor grouping, actor fusing, among others).

See:

http://wiki.ihe.net/index.php?title=IHE_Profile_Design_Principles_and_Conventions

That page describes a dependency as: A dependency is a requirement that when a system implements one profile/actor, it must also implement another profile/actor.

The key characteristics relevant to the questions are:

- a. Dependencies should be limited to situations where the dependent profile will not function or provide value if the other profile is not present. , AND*
- b. Dependencies should not be used for "useful synergies". Selection of profiles should be left to the user/market. If they want both they can ask for both.*

Using this definition/ criteria:

1. REWF is dependent on PDQ (needed to satisfy the important use case for unordered ECGs).

2. REWF is dependent on DRPT (needed to satisfy the use case for exporting displayable versions of the ECG reports).

3. REWF is NOT dependent on SWF or CATH or ECHO (REWF reuses many of the same actors & transactions, but describes how they are orchestrated to achieve ECG acquisition workflow).

4. REWF is not dependent on CT or ECG (Retrieve ECG for Display), since it appears that the overall Resting ECG Workflow Profile will be useful if these portions of the profile are not there. (I.e., this then would fall into the "useful synergies" category mentioned above (and on the Wiki page).

- 30 Should Acquisition Modality have an Unscheduled Workflow Option to require a grouping with a Patient Demographics Consumer actor? Should the Acquisition Modality have an Automatic Analysis Option to require a grouping with Evidence Creator?

No. In the end, the committee decided to let Acquisition Modality vendors claim the Patient Demographics Consumer actor from the PDQ profile if they want to offer that feature. They can also claim Evidence Creator is their product performs an automatic analysis. This is how IHE profiles are supposed to be used - products claim additional actors to advertise their additional features.

- 31 Should the Acquisition Modality have a Clinical Trials Option?

No – trial workflow is deferred to a future year.

Some current ECG devices are “trial aware”, meaning that they can be configured to know about things like trial protocols, subject IDs, and time points. If this were an option, claiming it would mean that the Acquisition Modality would be able to correctly fill the optional clinical trial modules in the DICOM objects. This would make downstream workflow easier because the ECG management system would not have to reconcile every ECG with the protocol information. This profile would not specify how the Acquisition Modality gets the information. The profile would not have a way to do “scheduled” trial workflow.

- 32 Acquisition Modality is required to be paired with a Time Client from Consistent Time (CT). This is because it records patient biosignals that may need to be synchronized with other recordings and interventions. Should Evidence Creator also be required to be paired with a Time Client? It creates evidence, and the time of evidence creation needs to be recorded, and may need to be auditable. This may be the time a cardiologist confirmed (signed) the final ECG findings.

No, there is no need to require the synchronization of the time on the overread interpretation with other modalities down to the second.

- 33 Should Evidence Creator use MPPS In Progress and MPPS Completed, or should it use Creator PPS In Progress and Creator PPS Completed transactions? Currently the Echo and Cath use MPPS In Progress and Creators PPS Completed.

REWF will use Creator PPS In Progress and Creator PPS Completed. IHE-Card will likely fix the other profiles to make them consistent.

- 34 Need to create mapping between DICOM SR and HL7 Annotated ECG fields. This is expected to be a straightforward administrative exercise.

Although this would be helpful, the REWF profile will not address the specific issues of clinical trial workflow at this time. Clinical trial ECG workflow will be addressed in a future cycle.

Volume 1 – Integration Profiles

115 1.7 History of Annual Changes

Add the following bullet to the end of the bullet list in section 1.7

- Added the Resting ECG Workflow (REWF) integration profile which specifies the integration of resting ECG acquisition and management devices with other healthcare IT systems to enable coordinated resting ECG workflow.

120

The following section is reproduced here from the Technical Framework for legal reasons.

1.9 Copyright Permission

125 Health Level Seven, Inc., has granted permission to the IHE to reproduce tables from the HL7 standard. The HL7 tables in this document are copyrighted by Health Level Seven, Inc. All rights reserved.

The National Electrical Manufacturers Association (NEMA) has granted permission to the IHE to incorporate portions of the DICOM standard.

Material drawn from these documents is credited where used.

130 *Add the following subsection to the Technical Framework and renumber any subsequent subsections on section 1.*

1.10 Patent Disclaimer

135 Attention is called to the possibility that implementation of the specifications in this document may require use of subject matter covered by patent rights. By publication of this document, no position is taken with respect to the existence or validity of any patent rights in connection therewith. IHE International is not responsible for identifying Necessary Patent Claims for which a license may be required, for conducting inquiries into the legal validity or scope of Patents Claims or determining whether any licensing terms or conditions provided in connection with submission of a Letter of Assurance, if any, or in any licensing agreements are reasonable or non-discriminatory. Users of the specifications in this document are expressly advised that 140 determination of the validity of any patent rights, and the risk of infringement of such rights, is entirely their own responsibility. Further information about the IHE International patent disclosure process including links to forms for making disclosures is available at http://www.ihe.net/Patent_Disclosure_Process/. Please address questions about the patent 145 disclosure process to the secretary of the IHE International Board: secretary@ihe.net.

2.1 Dependencies among Integration Profiles

Add the following to Table 2-1

Integration Profile	Depends on	Dependency Type	Comments
Resting ECG Workflow	ITI-TF: Consistent Time (CT)	Acquisition Modality must be grouped with Time Client from CT.	

150

Add the following NEW subsection to section 2.2

2.2.7 Resting ECG Workflow (REWF)

155 The Resting ECG Workflow (REWF) integration profile describes the workflow associated with digital electrocardiography. This will align ECG workflow and source-data transfer and storage with the existing IHE interoperability conventions and efficiencies used for imaging procedures. Similar to the Cath and Echo Workflow integration profiles, this profile deals with patient identifiers, orders, scheduling, status reporting, and data storage. It also addresses the issues of acquisition modality devices that are intermittently connected to the network, such as portable electrocardiograph machines, as well as ECG-specific data requirements. The Resting ECG Profile will handle the cases of unordered and urgent ECG tests and ECGs acquired in both hospital and office settings.

160

Add the following Actor definitions and updates to table 2.3-1 in section 2.3

2.3 Actor Descriptions

165 **Integrated ECG Manager** – A system that manages the acquisition workflow of resting ECGs.

Table 2.3-1: Integration Profile Actors

Actor \ Integration Profile	...	<u>REWF</u>
Acquisition Modality		<u>X</u>
ADT		<u>X</u>
Department System Scheduler/Order Filler		<u>X</u>
Evidence Creator		<u>X</u>
Image Display		<u>X</u>
Image Manager / Image Archive		<u>X</u>
<u>Integrated ECG Manager</u>		<u>X</u>
Order Placer		<u>X</u>

Integration Profile	...	<u>REWF</u>
Actor		
Performed Procedure Step Manager		<u>X</u>
Report Creator		<u>X</u>
Report Manager		<u>X</u>
Time Client		<u>(note 1)</u>

170 Add the following transaction(s) definitions to section 2.4 and update table 2.4-1 with the new
 REWF column and new transaction rows.

2.4 Transaction Descriptions

...

175 **Query Enhanced Modality Worklist** – An “enhanced” version of the “Query Modality Worklist” transaction supporting the additional matching keys for Admission ID and Scheduled Procedure Step Location. [CARD-12]

180 **Query Cardiology Images/Evidence** – An enhanced version of the “Query Images” and “Query Evidence Documents” queries that requires the “Performed Protocol Code Sequence” to be returned so resting ECGs can be distinguished from other ECG tests, like stress, and Holter. [CARD-13]

Table 2.4-1: Integration Profile Transactions

Integration Profile	...	<u>REWF</u>
Transaction		
Creator Procedure Step Completed [RAD-21]		<u>X</u>
Creator Procedure Step In Progress [RAD-20]		<u>X</u>
Encapsulated Report Submission [CARD-7]		<u>X</u>
Filler Order Management [RAD-3]		<u>X</u>
Instance Availability Notification [RAD-49]		<u>X</u>
Modality Procedure Step Completed [RAD-7]		<u>X</u>
Modality Procedure Step In Progress [CARD-1]		<u>X</u>
Modality Images/Evidence Stored [CARD-2]		<u>X</u>
Patient Registration [RAD-1]		<u>X</u>
Patient Update [RAD-12]		<u>X</u>
Placer Order Management [RAD-2]		<u>X</u>
Procedure Scheduled [RAD-4]		<u>X</u>
Procedure Update [RAD-13]		<u>X</u>
<u>Query Enhanced Modality Worklist [CARD-12]</u>		<u>X</u>
<u>Query Cardiology Images/ Evidence [CARD-13]</u>		<u>X</u>
Retrieve Images/Evidence [CARD-4]		<u>X</u>

Integration Profile	...	<u>REWF</u>
Transaction		
Storage Commitment [CARD-3]		<u>X</u>

Add NEW section 9

185 **9 Resting ECG Workflow (REWF)**

190 The Resting ECG Workflow (REWF) integration profile describes the workflow associated with digital electrocardiography. Similar to the Cath and Echo Workflow integration profiles, this profile deals with patient identifiers, orders, scheduling, status reporting, data storage, and reporting. It also specifically addresses the issues of acquisition modality devices that are only intermittently connected to the network, such as portable electrocardiograph machines, and addresses ECG-specific data requirements. The Resting ECG Workflow profile will also handle the cases of unordered ECG tests, trauma patients and ECGs acquired in both hospital and office settings.

9.1 Actors/Transactions

195 Figure 9.1-1 shows the actors directly involved in the Resting ECG Workflow integration profile and the relevant transactions between them.

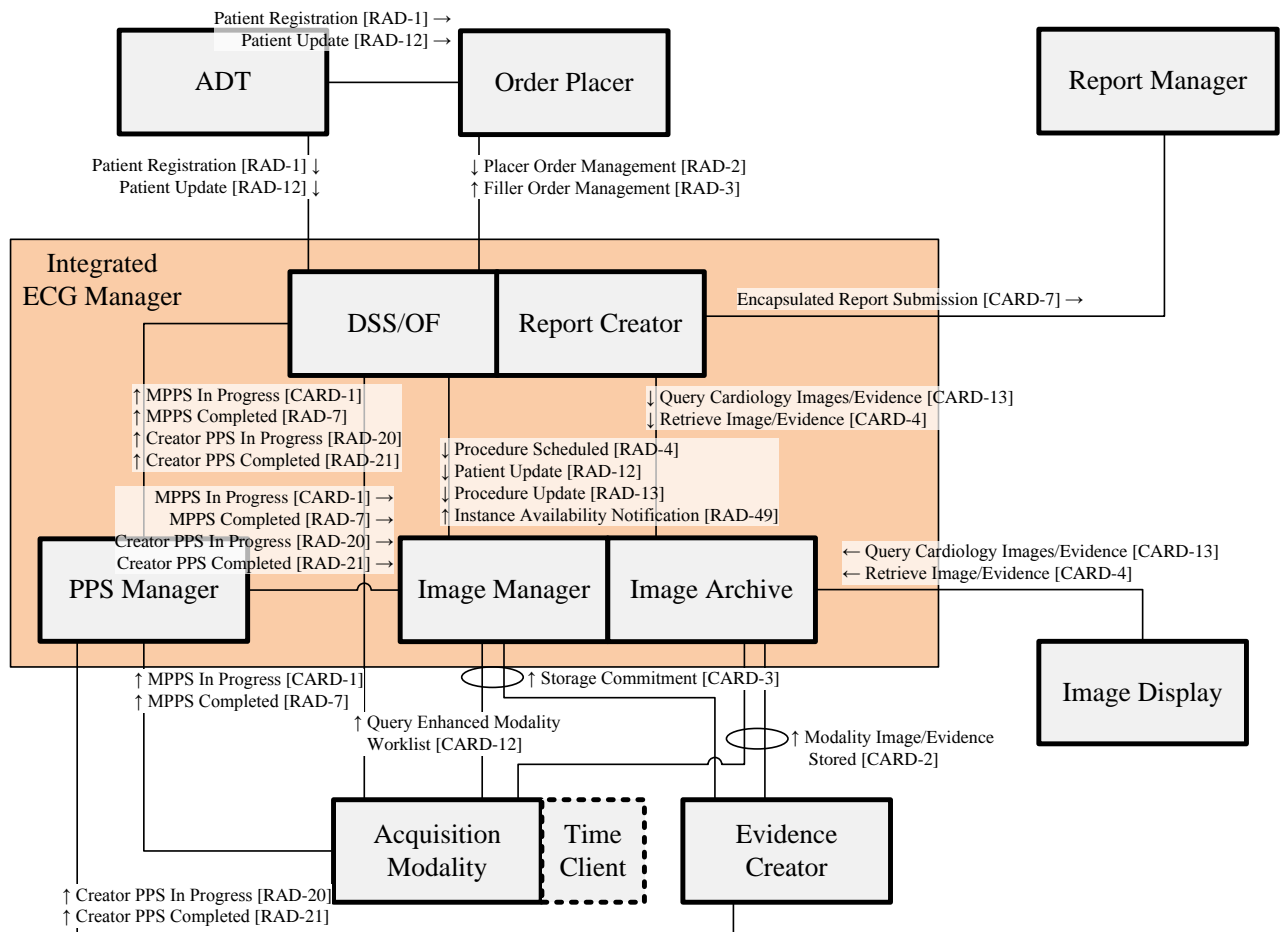

Figure 9.1-1: Resting ECG Workflow Diagram

200

Table 9.1-1 lists the transactions for each actor directly involved in the Resting ECG Workflow profile. In order to claim support of this integration profile, an implementation must perform the required transactions (labeled “R”). Transactions labeled “O” are optional. A complete list of options defined by this integration profile and that implementations may choose to support is listed in Volume 1, Section 9.2.

205

Table 9.1-1: Resting ECG Workflow - Actors and Transactions

Actors	Transactions	Optionality	Section
Acquisition Modality	Query Enhanced Modality Worklist [CARD-12]	R	CARD TF-2: 4.12
	Modality Procedure Step In Progress [CARD-1]	R	CARD TF-2: 4.1
	Modality Procedure Step Completed [RAD-7]	R	RAD TF-2: 4.7
	Modality Images/Evidence Stored [CARD-2]	R	CARD TF-2: 4.2
	Storage Commitment [CARD-3]	R	CARD TF-2: 4.3

IHE Cardiology Technical Framework Supplement – Resting ECG Workflow (REWF)

Actors	Transactions	Optionality	Section
ADT Patient Registration	Patient Registration [RAD-1]	R	RAD TF-2: 4.1
	Patient Update [RAD-12]	R	RAD TF-2: 4.12
Department System Scheduler/ Order Filler	Patient Registration [RAD-1]	R	RAD TF-2: 4.1
	Patient Update [RAD-12]	R	RAD TF-2: 4.12
	Placer Order Management [RAD-2]	R	RAD TF-2: 4.2
	Filler Order Management [RAD-3]	R	RAD TF-2: 4.3
	Query Enhanced Modality Worklist [CARD-12]	R	CARD TF-2: 4.12
	Modality Procedure Step In Progress [CARD-1]	R	CARD TF-2: 4.1
	Modality Procedure Step Completed [RAD-7]	R	RAD TF-2: 4.7
	Creator Procedure Step In Progress [RAD-20]	R	RAD TF-2: 4.20
	Creator Procedure Step Completed [RAD-21]	R	RAD TF-2: 4.21
	Procedure Scheduled [RAD-4]	R	RAD TF-2: 4.4
	Procedure Updated [RAD-13]	R	RAD TF-2: 4.13
	Instance Availability Notification [RAD-49]	R	RAD TF-3: 4.49
Evidence Creator	Modality Images/Evidence Stored [CARD-2]	R	CARD TF-2: 4.2
	Storage Commitment [CARD-3]	R	CARD TF-2: 4.3
	Creator Procedure Step In Progress [RAD-20]	R	RAD TF-2: 4.20
	Creator Procedure Step Completed [RAD-21]	R	RAD TF-2: 4.21
Image Display	Query Cardiology Images/ Evidence [CARD-13]	R	CARD TF-2: 4.13
	Retrieve Images/Evidence [CARD-4]	R	CARD TF-2: 4.4
Image Manager / Image Archive	Query Cardiology Images/ Evidence [CARD-13]	R	CARD TF-2: 4.13
	Retrieve Images/Evidence [CARD-4]	R	CARD TF-2: 4.4
	Modality Images/Evidence Stored [CARD-2]	R	CARD TF-2: 4.2
	Patient Update [RAD-12]	R	RAD TF-2: 4.12
	Procedure Updated [RAD-13]	R	RAD TF-2: 4.13
	Procedure Scheduled [RAD-4]	R	RAD TF-2: 4.4
	Instance Availability Notification [RAD-49]	R	RAD TF-3: 4.49
	Storage Commitment [CARD-3]	R	CARD TF-2: 4.3
	Modality Procedure Step In Progress [CARD-1]	R	CARD TF-2: 4.1
	Modality Procedure Step Completed [RAD-7]	R	RAD TF-2: 4.7
	Creator Procedure Step In Progress [RAD-20]	R	RAD TF-2: 4.20
	Creator Procedure Step Completed [RAD-21]	R	RAD TF-2: 4.21
Integrated ECG Manager	Patient Registration [RAD-1] (DSS/OF role)	R	RAD TF-2: 4.1
	Patient Update [RAD-12] (DSS/OF role)	R	RAD TF-2: 4.12
	Placer Order Management [RAD-2] (DSS/OF role)	R	RAD TF-2: 4.2
	Filler Order Management [RAD-3] (DSS/OF role)	R	RAD TF-2: 4.3
	Query Enhanced Modality Worklist [CARD-12] (DSS/OF role)	R	CARD TF-2: 4.12

Actors	Transactions	Optionality	Section
	Modality Procedure Step In Progress [CARD-1] (DSS/OF role)	R	CARD TF-2: 4.1
	Modality Procedure Step Completed [RAD-7] (DSS/OF role)	R	RAD TF-2: 4.7
	Creator Procedure Step In Progress [RAD-20] (DSS/OF role)	R	RAD TF-2: 4.20
	Creator Procedure Step Completed [RAD-21] (DSS/OF role)	R	RAD TF-2: 4.21
	Modality Images/Evidence Stored [CARD-2] (Image Manager role)	R	CARD TF-2: 4.2
	Storage Commitment [CARD-3] (Image Manager role)	R	CARD TF-2: 4.3
	Query Cardiology Images/ Evidence [CARD-13] (Image Archive role)	R	CARD TF-2: 4.13
	Retrieve Images/Evidence [CARD-4] (Image Archive role)	R	CARD TF-2: 4.4
	Encapsulated Report Submission [CARD-7] (Report Creator role)	R	CARD TF-2: 4.7
Order Placer	Patient Registration [RAD-1]	R	RAD TF-2: 4.1
	Patient Update [RAD-12]	R	RAD TF-2: 4.12
	Placer Order Management [RAD-2]	R	RAD TF-2: 4.2
	Filler Order Management [RAD-3]	R	RAD TF-2: 4.3
Performed Procedure Step Manager	Modality Procedure Step In Progress [CARD-1]	R	CARD TF-2: 4.1
	Modality Procedure Step Completed [RAD-7]	R	RAD TF-2: 4.7
	Creator Procedure Step In Progress [RAD-20]	R	RAD TF-2: 4.20
	Creator Procedure Step Completed [RAD-21]	R	RAD TF-2: 4.21
Report Creator	Encapsulated Report Submission [CARD-7]	R	CARD TF-2: 4.7
	Query Cardiology Images/Evidence [CARD-13]	R	CARD TF-2: 4.13
	Retrieve Image/Evidence [CARD-4]	R	CARD TF-2: 4.4
Report Manager	Encapsulated Report Submission [CARD-7]	R	CARD TF-2: 4.7

In each of the transactions assigned in table 9.1-1, actors shall implement the HL7 v2.5.1 Message Semantics when such semantics are defined. Those transactions are:

- 210
- Patient Registration [RAD-1]
 - Placer Order Management [RAD-2]
 - Filler Order Management [RAD-3]
 - Procedure Scheduled [RAD-4]
 - Patient Update [RAD-12]
- 215
- Procedure Updated [RAD-13]

9.1.1 Required and Suggested Actor Groupings

9.1.1.1 Acquisition Modality

The Acquisition Modality shall be grouped with the Time Client actor of the ITI Consistent Time (CT) Profile, as specified in ITI-TF 1:7.

220 The Acquisition Modality may be grouped with the Patient Demographics Consumer actor of the ITI Patient Demographics Query (PDQ) profile. This is useful when the Acquisition Modality needs to lookup patient demographics for unscheduled exams.

225 The Acquisition Modality may be grouped with an Evidence Creator in this profile. When grouped, the Acquisition Modality can generate and store measurements and interpretations of the ECG. This is most often done automatically with a signal processing algorithm. However, the measurements and interpretations may also be provided directly by a clinician.

9.1.1.2 Image Display

230 Image Display may be grouped with Evidence Creator if the actors are part of an analysis and reporting workstation. The Evidence Creator will store the measurements and interpretations made by the system’s algorithms and/or the clinician reviewing the ECGs.

9.1.1.3 Integrated ECG Manager

235 The Integrated ECG Manager combines the functionality of the Department System Scheduler/ Order Filler, PPS Manager, Image Manager/ Archive, and Report Creator in an integrated implementation. In such an integrated implementation, the transactions between the combined actors are not externalized; i.e., communication of PPS status, instance availability, scheduled procedures, demographics updates, and retrieval of ECG data for report creation are solely the internal responsibility of the Integrated ECG Manager.

9.1.1.4 Department System Scheduler/ Order Filler and Report Creator Grouping

240 The Department System Scheduler/ Order Filler Actor in this profile shall be grouped with the Report Creator Actor in this profile and vice versa. The required grouping enables the initiation of report creation activities based on business logic within the DSS/OF without the need for an explicitly defined, standards-based triggering message.

9.2 Resting ECG Workflow Integration Profile Options

245 Options that may be selected for this Integration Profile are listed in the table 9.2-1 along with the Actors to which they apply. Dependencies between options when applicable are specified in notes.

Table 9.2-1: Resting ECG Workflow - Actors and Options

Actor	Option Name	Optionality	Vol. & Section
Acquisition Modality	Broad Worklist Query	R	CARD-TF 2:4.12.1

Actor	Option Name	Optionality	Vol. & Section
	Patient Based Worklist Query	O	CARD-TF 2:4.12.1
ADT Patient Registration	<i>No options defined</i>	-	-
Department System Scheduler/ Order Filler	<i>No options defined</i>	-	-
Evidence Creator	<i>No options defined</i>	-	-
Image Manager / Image Archive	Intermittently Connected Modality	R	CARD-TF 2: 4.3
Integrated ECG Manager	Intermittently Connected Modality	R	CARD-TF 2: 4.3
Order Placer	<i>No options defined</i>	-	-
Performed Procedure Step Manager	<i>No options defined</i>	-	-
Report Creator	<i>No options defined</i>	-	-
Report Manager	<i>No options defined</i>	-	-

250 9.3 Resting ECG Workflow Process Flow

9.3.1 Normal Priority, Scheduled ECGs

This use case covers normal priority, scheduled ECG workflow in a hospital setting.

Clinical Context

255 When John arrives at the hospital for his cardiac procedure, a clerk registers and admits him. John is placed into a bed in the cardiac care unit (CCU) which is located in the hospital's west wing. Dr. Vessel who will be performing the procedure sees John and orders a pre-procedure ECG to verify John can still go through with the procedure. The ECG is scheduled to be done "now", but at the normal priority.

260 Meanwhile, Betty makes her rounds acquiring ECGs. When she is ready to acquire ECGs in the west wing, she downloads orders scheduled in the west wing for the next hour. She sorts the list by department and makes her way to the nearest one, CCU. She sees John in CCU is scheduled to have an ECG. Although the cart displays John's room number, she checks at the nurse's station to verify John's current room and bed. She goes to John's bed and verifies his identity by talking to him and looking at his wristband. She selects John's order to start a new ECG with
265 John's demographics. She enters her initials as the performing technician. She connects the electrodes and acquires a resting ECG. The cart automatically prints the ECG waveforms along with measurements and interpretation statements it automatically created. She verifies the quality of the ECG, and then disconnects John and uploads the ECG to the information system. The cart then displays the current list of ECG orders for Betty so she can decide where to go next.

270 While still in his office, Dr. Vessel reviews John's condition to verify he can still have the procedure. He reviews the preliminary ECG that was created from the cart's automatic measurements and interpretation statements. Everything is OK, so he performs the procedure. After the procedure, Dr. Vessel orders ECGs to be acquired every 12 hours while John recovers.

275 Meanwhile, it is Dr. Wave’s day to read ECGs. He is presented with a list of ECGs that have not been reviewed yet. When he reviews John’s ECG, he also looks at John’s ECGs from when he was here 6 months ago. Dr. Wave verifies the heart rate, PR, QRS, and QT measurements. He changes a few of the automatic interpretation statements and then finalizes the ECG with his electronic signature.

280 2 days after the procedure, Dr. Vessel reviews John’s progress from his office. He views all of John’s (final) ECGs and verifies John is ready to go home.

IHE Context

285 The patient is registered and admitted as an inpatient within the ADT system. The ADT notifies the DSS/OF and Order Placer systems of the new registration and admission. The ECG is ordered and scheduled within the Order Placer, and it notifies the DSS/OF. The DSS/OF in turn notifies the Image Manager. Meanwhile, the ECG technician periodically refreshes the list of ECGs to be performed. The Acquisition Modality does a broad query for ECGs to be performed in the technician’s area of the hospital within the next hour. She sorts the list by scheduled location, goes to the first patient, and selects the workitem from the list.

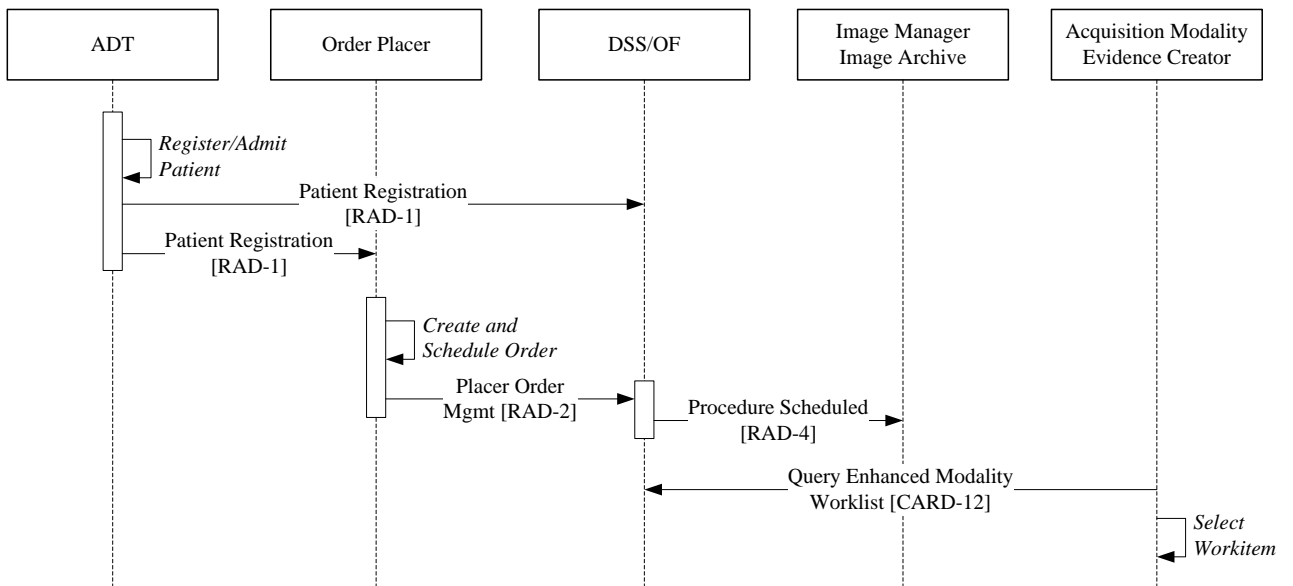

290 **Figure 9.3.1-1: Registration and Scheduling**

295 When the technician selects the workitem, the Acquisition Modality notifies the DSS/OF that the procedure is in progress. The technician acquires the ECG, and the cart uses a signal processing algorithm to produce automatic measurements and interpretation statements (evidence). The Acquisition Modality notifies the DSS/OF that the procedure is completed, and the DSS/OF informs the Order Placer. The Acquisition Modality stores the ECG waveforms in the Image Archive, and then it stores the evidence. The Image Manager notifies the DSS/OF that the ECG is available. The Acquisition Modality also requests a Storage Commitment. Because ECG Acquisition Modalities are typically intermittently connected, the Image Manager uses this as a

300 trigger to send all previously unsent Storage Commitment responses to the Acquisition Modality. The Acquisition Modality deletes those ECGs from its persistent memory.

The diagram below shows the most likely grouping of PPS Manager with DSS/OF. Therefore, DSS/OF receives the MPPS messages from the Acquisition Modality and then forwards them to Image Manager.

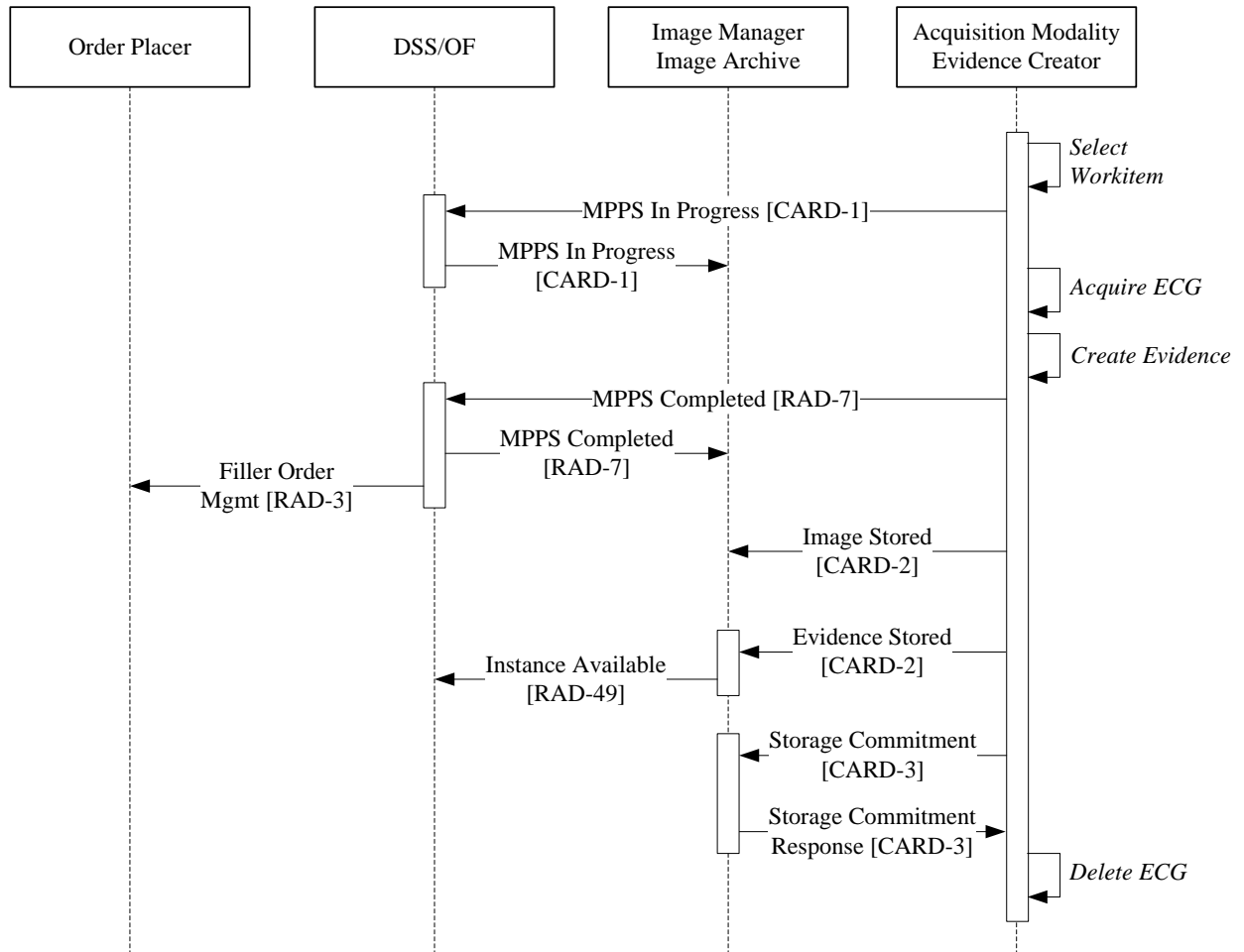

305 **Figure 9.3.1-2: Resting ECG Acquisition**

310 Upon receiving Instance Available, the Report Creator retrieves the ECG waveforms and automatic analysis produced by the Acquisition Modality. It turns the demographics, measurements, interpretations, and waveforms into a PDF report and submits it to the Report Manager as a preliminary report. Please refer to the Displayable Reports Profile (DRPT) for more information about how the reports are managed and distributed throughout the enterprise.

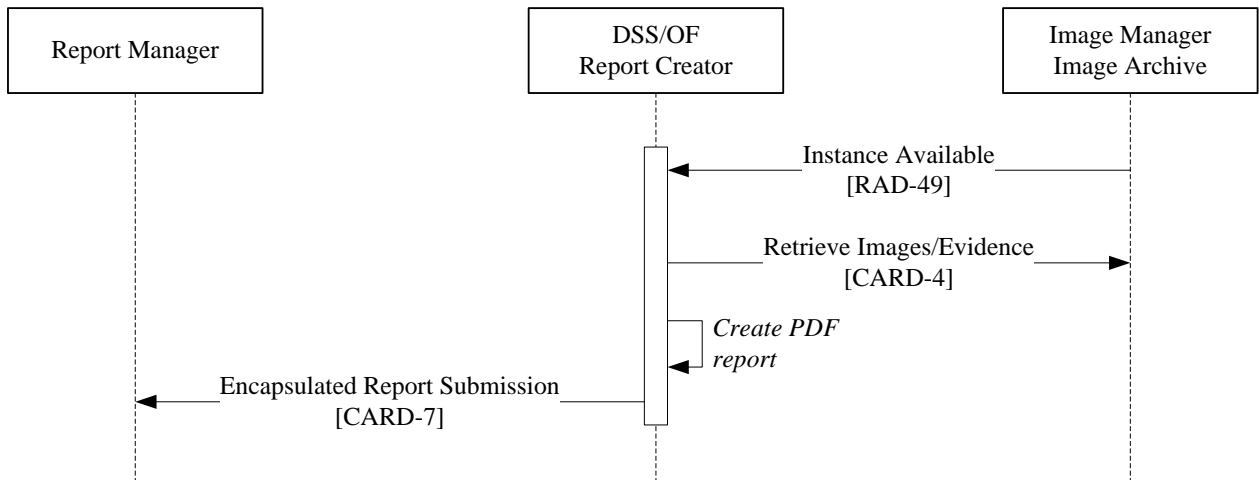

Figure 9.3.1-3: Encapsulated Report Submission

315

It is currently beyond the scope of this profile to specify how the overreading cardiologist knows which ECGs need to be reviewed and confirmed. It is assumed that an ECG reporting workstation used by the overreading cardiologist is composed of at least an Image Display and an Evidence Creator actor. When the cardiologist decides to overread an ECG, the Image Display does a study-level query for all the patient’s ECGs. The study-level query will include the waveforms and all evidence (preliminary and final). An (ECG) Image Display will most likely be expected to present the current and several prior ECGs to the overreading cardiologist. The Image Display will use the returned Protocol Code Sequence to determine which studies were resting ECGs as opposed to other types of studies or monitoring sessions.

320

325

After querying for the list of all the patient’s ECGs, the Image Display retrieves the ones it will display. The overreading cardiologist uses onscreen tools to compare, measure, and interpret the ECG to be finalized. He creates new measurements and interpretations and signs the final results. Evidence Creator stores the new evidence with the ECG waveforms. Image Manager notifies DSS/OF of the newly available instance. Evidence Creator sends PPS “in progress” and “complete” messages to DSS/OF. DSS/OF notifies the Order Placer that the ECG overreading has been finalized (this may trigger billing events). Finally, Evidence Creator requests a Storage Commitment for the new evidence.

330

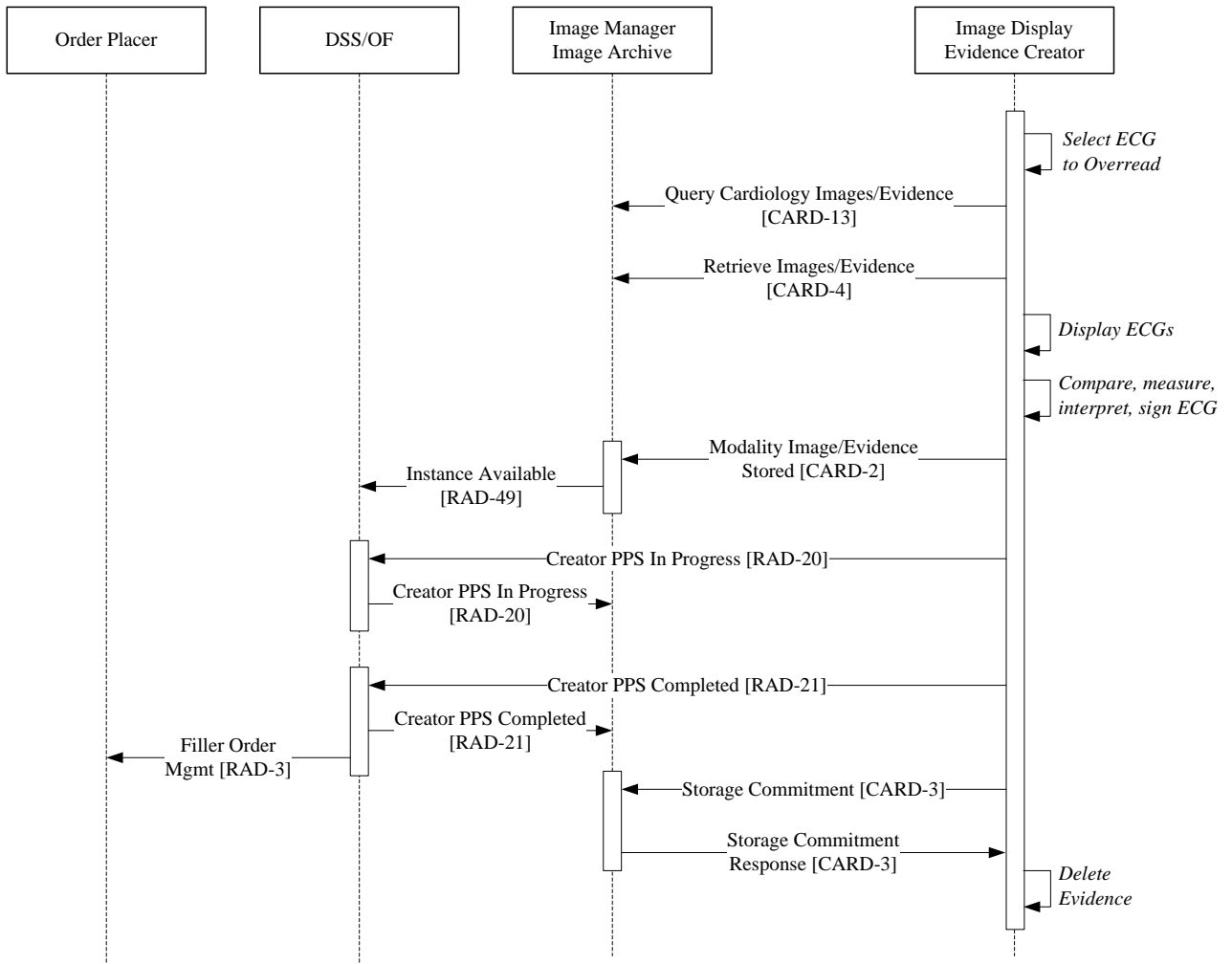

Figure 9.3.1-4: Reporting Flow

335

Upon receiving Instance Available, the Report Creator creates and submits a final, displayable report. See figure 9.3.1-3.

9.3.2 Urgent ECG, Unidentified Patient

340 This use case deals with an unidentified patient who needs an ECG taken as soon as he’s wheeled into the emergency department.

Clinical Context

An unidentified patient arrives at the emergency department. He is given a “John Doe” registration while he is wheeled into triage for a 12-lead ECG. The nurse enters John Doe’s temporary ID into the electrocardiograph and takes an ECG.

345 The ECG is uploaded to the ECG management system and printed on the electrocardiograph. The printed ECG is shown to the ED physician who sees ST elevation and others signs of cardiac ischemia. He initiates their STEMI protocol and pages the interventional cardiologist on call. Before leaving, the cardiologist quickly logs into the hospital’s EMR from his home to view the ECG just taken. He heads to the hospital’s cath lab to perform diagnostic and interventional
350 procedures.

Meanwhile, the patient’s wife arrives, and she provides the registration clerk with her husband’s demographic information. The clerk enters his information and merges it with John Doe’s records.

IHE Context

355 The patient is registered as “John Doe” in the ADT. The ADT sends registration messages to DSS/OF and the Order Placer. In the meantime, an ED nurse starts the urgent ECG by entering John Doe’s temporary patient ID, approximate age, and gender using the device’s keyboard. The Acquisition Modality sends an “in progress” message to DSS/OF for the ad hoc test. DSS/OF does not send a Filler Order Management message to Order Placer because this ECG is
360 unordered. The Acquisition Modality acquires the ECG and performs its automatic analysis. It prints the ECG so the clinicians at the point of acquisition can make quick decisions about the patient.

The Acquisition Modality sends a completed message to DSS/OF. The Acquisition Modality stores the ECG waveforms and automatic evidence in Image Archive, and then Image Manager sends the Instance Available message to DSS/OF. The Acquisition Modality sends the Storage Commitment message to Image Manager to transfer long term archive responsibility. Image
365 Manager sends all previously unsent Storage Commitment responses to the Acquisition Modality, and the Modality deletes those ECGs from its persistent memory.

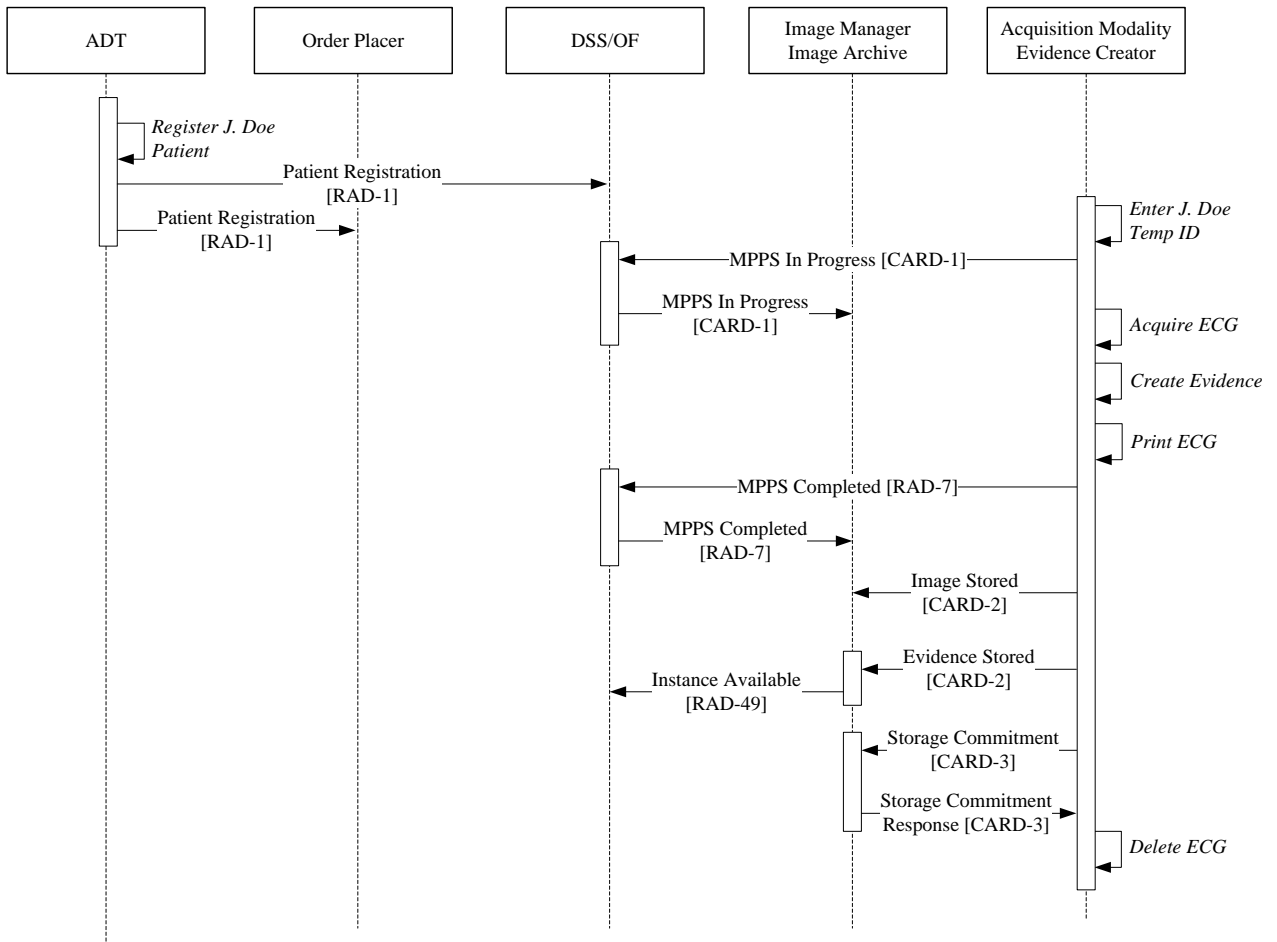

370

Figure 9.3.2-1: John Doe Acquisition Workflow

Like the scheduled case, Report Creator submits a displayable version of the preliminary report to the Report Manager so the interventionist can see the ECG from his home before departing. He must view the ECG using the temporary “John Doe” patient ID.

375

When the correct demographics are entered into the ADT, the information is merged into stored ECGs.

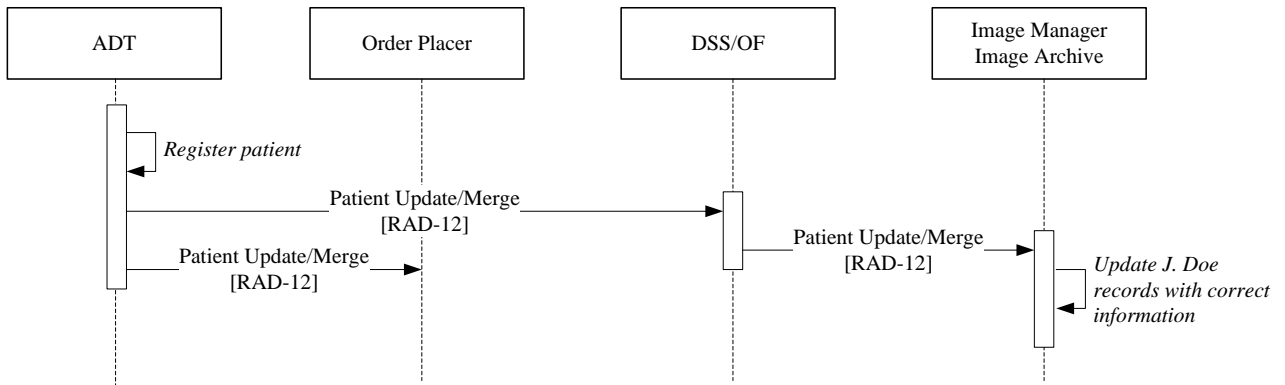

Figure 9.3.2-2: Patient Merge

380 **9.3.3 Scheduled ECG While Offline**

1. Every hour, a tech from the hospital’s central ECG lab makes rounds to collect ECGs. The hospital does not have a WLAN, so her cart is only connected to the network when it is back in the ECG lab. Before leaving the lab, the tech plugs into the LAN and downloads the current list of ECG orders scheduled for the next hour. The tech sorts the orders by care area heads off to the first one.
- 385 2. Meanwhile, an urgent ECG order is placed while the tech is making her rounds. She is paged and informed that an urgent ECG must be taken on a particular patient. The tech does not have the opportunity to plug into the LAN and download more orders, so she looks at the patient’s wristband and enters the patient’s MRN, name, DOB, and gender using the cart’s keyboard.
- 390 3. Once back to the ECG lab, the tech plugs into the LAN and synchronizes the cart. The cart uploads the newly acquired ECGs and downloads the most recent list of ECG orders. Later, an ECG management clerk finds the ECG that is not already matched to an order. She finds the correct order and reconciles the order to the ECG.

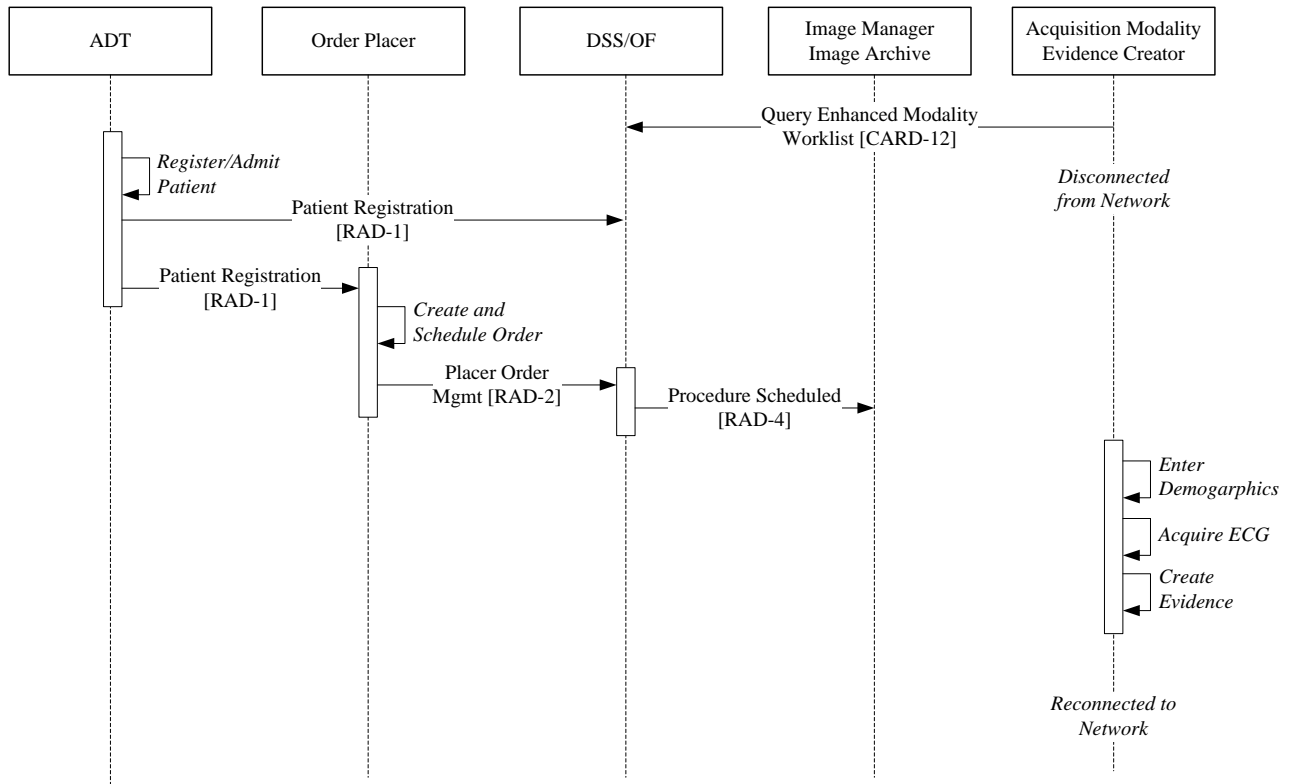

Figure 9.3.3-1: Urgent Order, Disconnected Modality

395

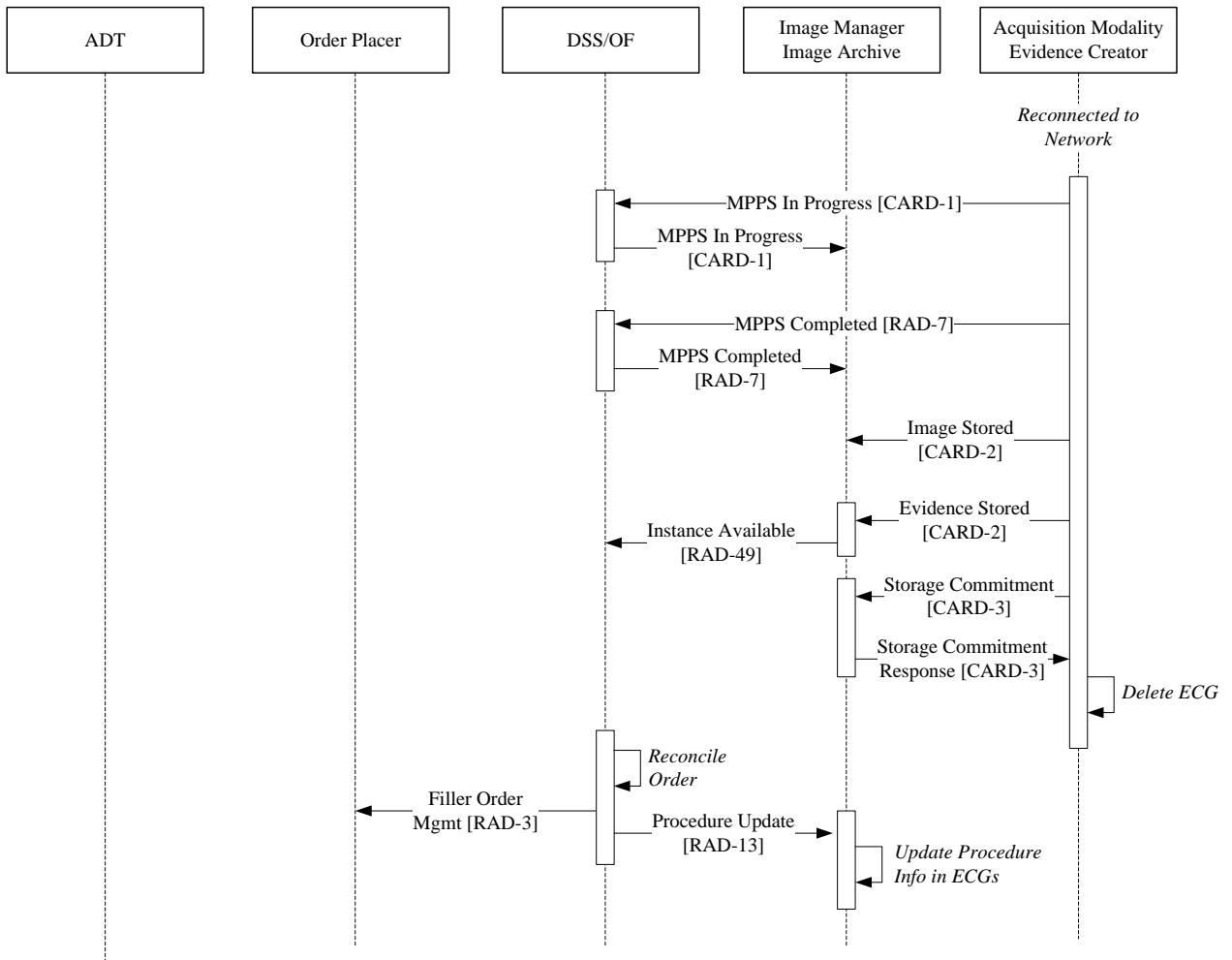

Figure 9.3.3-2: Order Reconciliation

400

9.3.4 Other use cases not completely covered by REWF

The following describe other resting ECG scenarios that are not fully addressed in this profile. These are only intended to be informative.

9.3.4.1 Patient Demographics for Unscheduled ECGs

405

Some institutions do not need to track ECG orders. They do not need to capture who made the decision to take an ECG or when. Care givers know under what circumstances ECGs must be taken based on symptoms and care protocols. When physicians decide to perform ECGs under other circumstances, the decision is communicated outside the usual information systems and interactions.

410

Patients are still registered in these institutions, so the Acquisition Modality needs to query for the demographics because there is no order. The ECG technician will typically scan the patient's

ID bracelet to enter a Patient ID or Admission ID. The Acquisition Modality will query for a list of matching patients and display those to the technician. The technician will need to pick one from the list, or confirm the single record returned before proceeding with the ECG acquisition.

415 When the ECG is stored, there is no need to notify the Order Placer of the order's status, nor is there any need to do orders reconciliation.

To support this use case, the Acquisition Modality should be grouped with a Patient Demographics Query (PDQ) Consumer. The PDQ Consumer will query for patient demographics using the Patient Demographics Query [ITI-21] and Patient Demographics And Visit Query [ITI-22] transactions. When the list of matching patients is returned, the Acquisition Modality will present the list and the technician will select the correct patient.

420

9.3.4.2 Clinical Trials

ECGs are often collected to study the effects of pharmaceuticals on the heart's electrical activity. Although the REWF profile may already have most or all of the framework to support ECG workflow in clinical trials, there are a lot of details to consider. There may also be significant overlap with other IHE profiles such as Radiology's Teaching File and Clinical Trial Export (TCE) profile. ECG clinical trial workflow should be addressed in a separate profile.

425

9.3.4.3 Physician's Office

Physician office and clinic workflow is focused around patient visits. The patient is registered and shown into an exam room. The patient's history, current symptoms, and vitals are recorded in the practice management (PM)/EMR system. While the physician is examining the patient, he may decide to take an ECG by clicking a "Take ECG" button in the PM/EMR system. The ECG is automatically populated with the patient's demographics. After taking the ECG, the physician will view the ECG and may immediately overread and confirm it.

430

This case is mostly covered by the Image Enabled Office (IEO) profile. This can be handled like any other scheduled ECG workflow. When the "Take ECG" button is clicked, the Order Placer immediately places an ECG order and schedules it for the exam room where the button was clicked. If the Acquisition Modality is a PC-based ECG device, it will be launched by the PM/EMR after the order is scheduled. Upon initialization, the PC-based ECG device will do a broad query using its unique AE Title. The DSS/OF will return the just-scheduled workitem for that exam room.

435

440

Many PC-based ECG devices will display the ECG and allow the ECG to be overread and confirmed. After confirmation, the ECG device will store the waveforms and confirmed evidence.

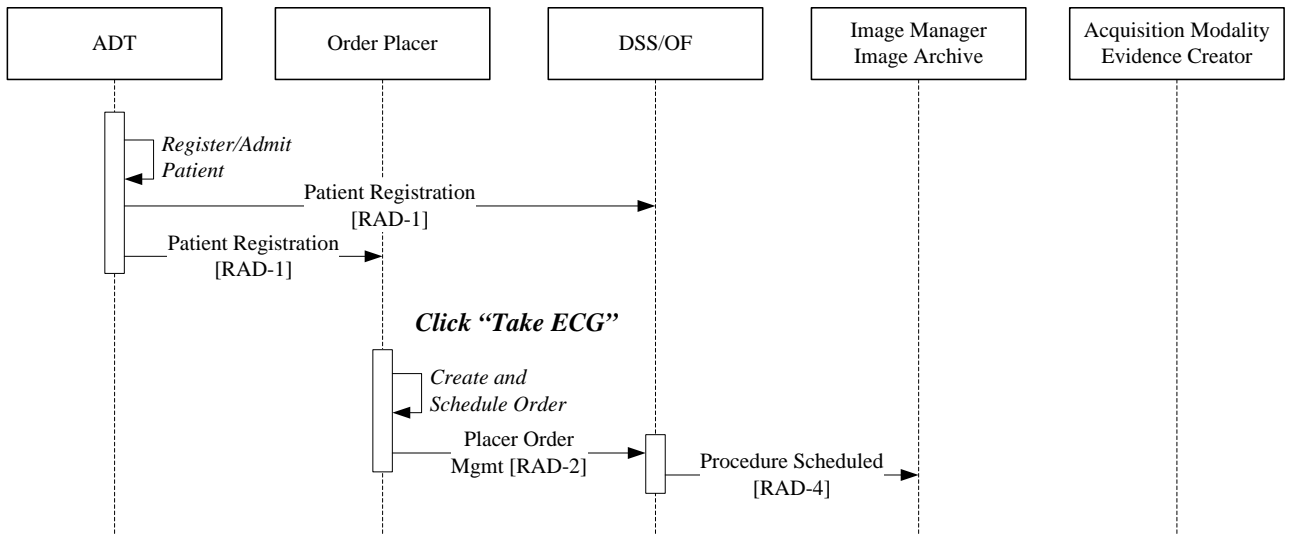

445

Figure 9.3.4-1: Office ECG Scheduling

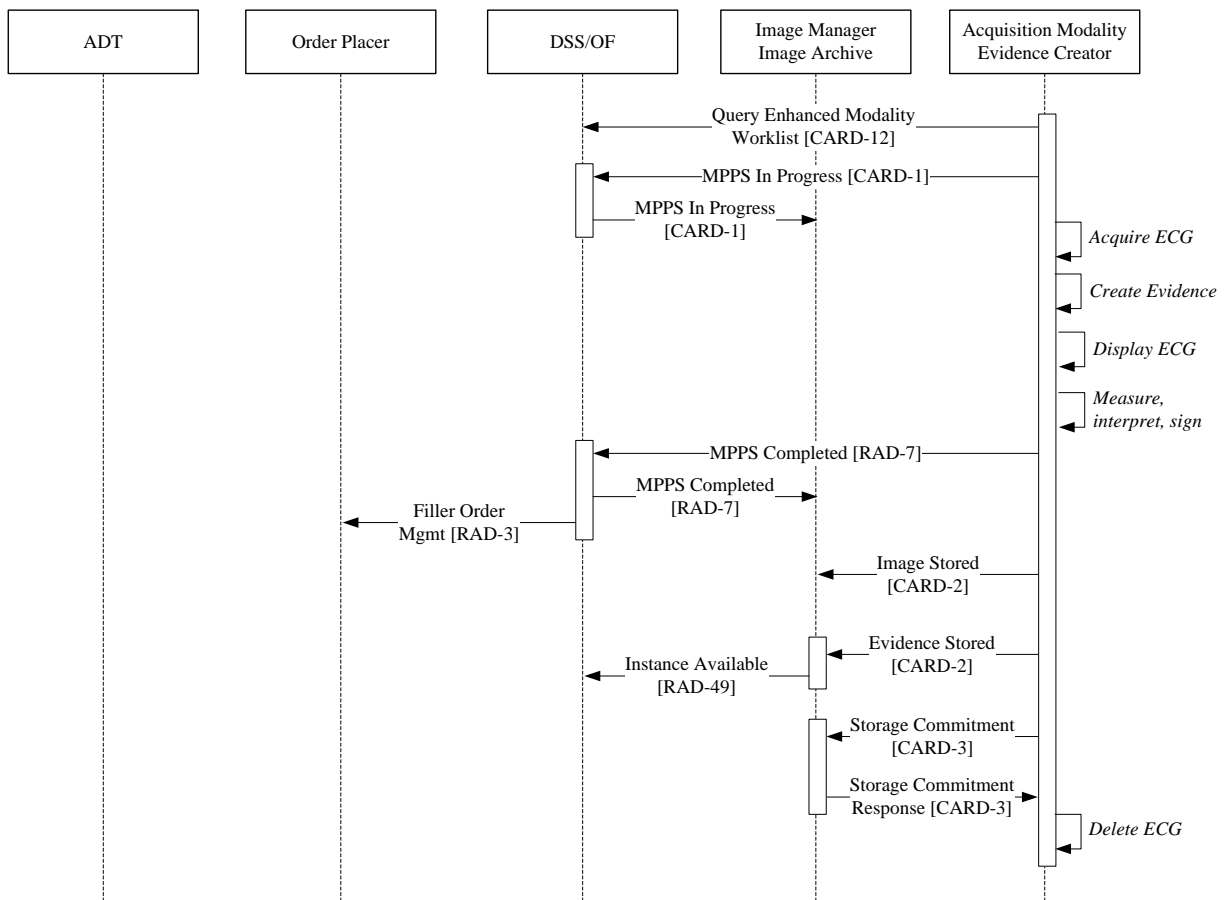

Figure 9.3.4-2: Office ECG Acquisition and Confirmation

450

9.4 Resting ECG Workflow Security Considerations

None

Volume 2 – Transactions

455

Modify the CARD-2 (Modality Images/Evidence Stored) transaction, by adding a NEW section 4.2.9

4.2 Modality Images/Evidence Stored [CARD-2]

...

460 4.2.9 Resting ECG Workflow Profile Behavior

The following subsections describe the requirements that are specific to the actors that create, transmit and store DICOM ECG Waveform and DICOM SR encoded ECG Evidence objects associated with the Resting ECG Workflow Profile.

465 Acquisition Modality actors supporting the Resting ECG Workflow Profile (REWF) shall support the General ECG Waveform Storage SOP Class. Image Archive actors supporting the Resting ECG Workflow shall support both SOP classes listed in table 4.2.9-1 below.

Table 4.2.9-1: Resting ECG SOP Classes

SOP Class UID	SOP Class Name
1.2.840.10008.5.1.4.1.1.9.1.2	General ECG Waveform Storage
1.2.840.10008.5.1.4.1.1.88.22	Enhanced SR

470 Evidence Creator actors shall use the Enhanced SR SOP Class with ECG Report template 3700 as specified in the table below when creating and storing ECG reports including measurements and interpretations.

Table 4.2.9-2: Resting ECG Report Template

Resting ECG Report Template
3700 ECG Report

475

Note: DICOM CP-1079 has been submitted to address the following resting ECG issues in TID 3700 and its associated sub templates:

- Extend TID 3717 to allow multiple reason statements to be associated with each interpretation statement.
 - Remove the mandatory use of SCP codes in 3713.
- 480

- Add other global measurements (CIDs).

485 The General ECG Waveform object allows between 1 and 4 waveform sequences and up to 24 ECG waveform channels of arbitrary duration. To allow downstream actors to distinguish a resting ECG test from other ECG tests, this profile shall require the use of the Performed Protocol Code Sequence (0040,0260) attribute as detailed in the table below. The SNOMED code P2-3120A “12-lead ECG” shall be used as a generic term to indicate a resting ECG regardless of the number of channels acquired.

490 The number of waveform sequences for resting ECGs shall also be limited from its current maximum limit of 4 to 2 as specified in the table below. The Waveform Sequence (5400,0100) attribute shall be limited to 2 waveform sequences (one for rhythm data and another for median data).

The ECG Acquisition Modality is also required to populate other attributes as described in table 4.2.9-3 below. Rationale for IHE strengthening these DICOM requirements is provided.

495 **Table 4.2.9-3: Resting ECG Required Attributes**

Attribute Name	Tag	Requirement	Required Value (if applicable)	Rationale
General Series Module				
Performed Protocol Code Sequence	(0040,0260)	R+		Needed to distinguish resting ECGs from other ECG types
>Code Value	(0008,0100)	R+	“P2-3120A”	
>Coding Scheme Designator	(0008,0102)	R+	“SRT”	
>Code Meaning	(0008,0104)	R+	“12-lead ECG”	Current SNOMED definition (a.k.a. resting ECG)
>Coding Scheme Version	(0008,0103)	O		
Waveform Module				
Waveform Sequence	(5400,0100)	R	2 sequence items required	one multiplex group for rhythm data and another for median data
>Multiplex Group Label	(003A,0020)	R+	Rhythm: “RHYTHM” Median: “MEDIAN_BEAT”	
>Channel Definition Sequence	(003A,0200)	R		(already required by DICOM to contain 1 sequence item per channel/ lead)
>>Channel Status	(003A,0205)	R+		Needed for display
>>Filter Low Frequency	(003A,0220)	R+		Needed for display. Even if a high pass filter hasn’t been

Attribute Name	Tag	Requirement	Required Value (if applicable)	Rationale
				applied to the data, this will be device bandwidth lower cutoff frequency.
>>Filter High Frequency	(003A,0221)	R+		Needed for display. Even if a low pass filter hasn't been applied to the data, this will be device bandwidth upper cutoff frequency.
>>Notch Filter Frequency	(003A,0222)	R+		Needed for display. Required if Notch filter is applied.

Modify the CARD-4 (Retrieve Images/Evidence) transaction, by adding a NEW section 4.4.6

4.4 Retrieve Images/Evidence [CARD-4]

....

500 4.4.6 Scope within the Resting ECG Workflow Profile

The following subsections describe the requirements that are specific to the actors within the Resting ECG Workflow Profile that retrieve and display DICOM ECG Waveform and DICOM SR encoded ECG Evidence objects. In general, only the transaction specification subsections that are different from the “parent” transaction (RAD-16) have been included.

505 In Resting ECG Workflow, the Report Creator Actor is added as a C-CMOVE SCU and a C-STORE SCP.

4.4.6.1 Use Case Roles

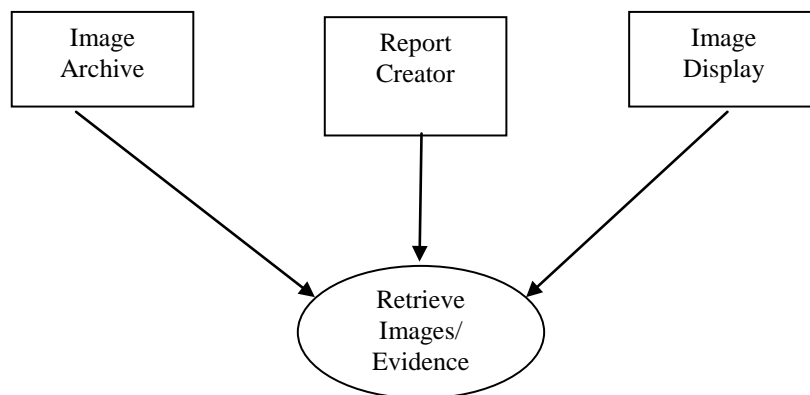

Actor: Image Archive

510 **Role:** Sends requested images, waveforms or evidence to the Image Display or Report Creator Actors.

Actor: Report Creator

Role: Receives requested images, waveforms or evidence from the Image Archive Actor.

Actor: Image Display

515 **Role:** Receives requested images, waveforms or evidence from the Image Archive Actor.

4.4.6.2 Interaction Diagram

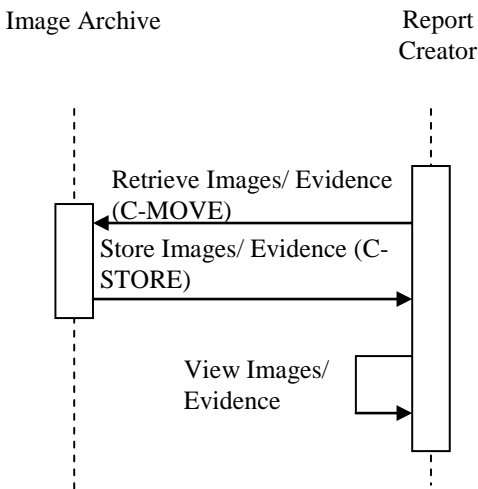
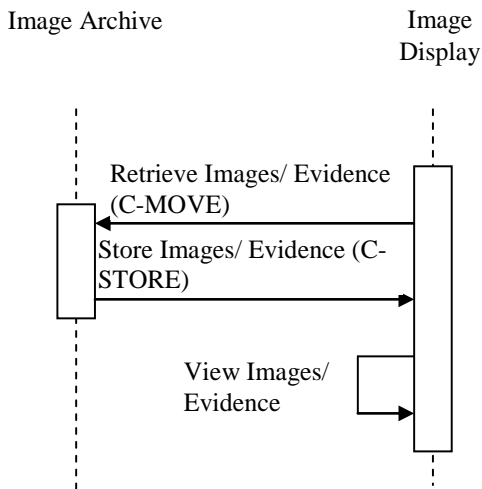

4.4.6.2.1 Message Semantics – Retrieve Images – Resting ECG Workflow

520 Image Manager/Archive, Report Creator and Image Display actors that support the Resting ECG Workflow Profile are required to support all of the SOP classes listed in Table 4.4.6-1 below.

Furthermore, the Report Creator and Image Display Actors shall be capable of displaying all the contents of an Enhanced SR SOP Class whose root template ID is TID 3700 – “ECG Report”.

525

Table 4.4.6-1: Resting ECG SOP Classes

SOP Class UID	SOP Class Name
1.2.840.10008.5.1.4.1.1.9.1.2	General ECG Waveform Storage
1.2.840.10008.5.1.4.1.1.88.22	Enhanced SR

4.4.6.3 Expected Actions – Resting ECG Workflow Profile

530

The Image Display and Report Creator actors shall render the ECG waveforms in a clinically relevant way. The actors shall be able to handle the display of representative beats and rhythm waveforms. Resting ECGs are typically not more than 15 leads or 10 seconds long.

Table 4.4.6-2 lists the information that an Image Display and Report Creator shall be capable of displaying along with a reference to where that information is expected to come from.

Table 4.4.6-2: Resting ECG Required Display Attributes

Displayable Information	Source Value/ Derivation
Type of Waveform Group (Rhythm vs. Median beat)	Value taken from Multiplex Group Label (0037,0020)
Channel/ Lead Name	Value taken from Channel Source Sequence (003A,0208)::Code Meaning (0008,0104)
Channel Status	Value taken from Channel Status (003A,0205).
Voltage scale	Derived from Channel Sensitivity (003A,0210) and display gain. Gain is normally 10mm/mV.
Time scale	Derived from Sampling Frequency (003A,001A) and display speed. Waveform speed is normally 25 mm/s.
Frequency content	Waveform bandwidth. Values taken from Filter Low Frequency (003A,0220), Filter High Frequency (003A,0221), and Notch Filter Frequency (003A,0222) (if present).
Acquisition time	Value taken from Acquisition DateTime (0008,002A)

535

Modify the CARD-7 (Encapsulated Report Submission) transaction, by adding a NEW section 4.7.x

4.7 Encapsulated Report Submission [CARD-7]

....

540 **4.7.x Resting ECG Workflow Profile Behavior**

Report Creator in the REWF profile shall submit displayable ECGs that conform to the requirements described in the Retrieve ECG Document for Display (CARD-6) transaction. Volume 2, section 4.6.4.2.2 establishes minimum requirements for the display of demographics, recording context, waveform fidelity, waveform information, and interpretation.

545 The Report Creator in REWF shall also include discrete results in OBX segments of the HL7 message. Downstream systems can use this information to populate their databases. They can use the data for clinical and management reports, as well as outcomes research. The following table lists the results to be included in OBX segments.

References:

- 550
- TTID 3713 (ECG Global Measurements)
 - TTID 3717 (ECG Qualitative Analysis)
 - TTID 3719 (ECG Summary)

Table 4.7.x-1: Discrete Values to Accompany Displayable ECGs

Parameter	OPT	OBX-2 Value Type	OBX-3 Obs. ID	OBX-5 Value	OBX-5 REP	OBX-6 Units	OBX-17 Obs Method
Ventricular Heart Rate	R	NM	2:16016, MDC, "Ventricular Heart Rate"			/min	
Atrial Heart Rate	O	NM	2:16020, MDC, "Atrial Heart Rate"			/min	
R-R Interval	R	NM	2:16168, MDC, "RR interval global"			ms	
P-P Interval	O	NM				ms	
QRS Duration	R	NM	2:16156, MDC, "QRS duration global"			ms	
PR interval	R	NM	2:15872, MDC, "PR interval global"			ms	
QT interval	R	NM	2:16160, MDC, "QT interval global"			ms	
QT Corrected interval	O	NM	2:16164, MDC, "QTc interval global"			ms	Taken from: DCID(3678) QT Correction Algorithms
P Axis	O	NM	2:16128, MDC, "P Axis"			deg	
QRS Axis	O	NM	2:16132, MDC, "QRS Axis"			deg	
T Axis	O	NM	2:16136, MDC, "T Axis"			deg	
Clinical Interpretation	R	TX	18844-1, LN "EKG impression"		Yes (Note 1)		
Finding	O	CE	18810-2, LN "EKG	Taken from:			

Parameter	OPT	OBX-2 Value Type	OBX-3 Obs. ID	OBX-5 Value	OBX-5 REP	OBX-6 Units	OBX-17 Obs Method
(Summary)			overall finding”	DCID (3677) Summary Codes ECG			

555

Notes:

1. Clinical interpretation can consist of multiple statements. Each statement shall be represented as a repeating value within OBX-5. This provides data to the consuming application that allows it to present the information in a legible format.
2. Each row in the table shall be included in the MDM message as a separate OBX segment.

560

Adapted from DICOM CID 3677 Summary Codes ECG (as modified by CP-1079)

Coding Scheme Designator	Code Value	Code Meaning
SCT2	F-000B7	Normal ECG
SCT2	F-38002	Abnormal ECG
SCT2	F-38056	Borderline Normal ECG

Note: HL7v2 uses the coding scheme designator SCT2 for SNOMED “RT-style”, while DICOM uses SRT.

DICOM CID 3678 QT Correction Algorithms

Coding Scheme Designator	Code Value	Code Meaning
DCM	122730	Bazett QT Correction Algorithm
DCM	122731	Hodges QT Correction Algorithm
DCM	122732	Fridericia QTc Algorithm
DCM	122733	Framingham QTc Algorithm

565

Add NEW transaction, section 4.12 to Volume 2

4.12 Query Enhanced Modality Worklist [CARD-12]

570

This transaction (CARD-12) is based upon the Query Modality Worklist [RAD-5] Transaction (see RAD-TF 2: 4.5), with additional query matching keys that are required to be supported as part of the Message Semantics section portion of the ‘Query Scheduled MWL’ message specification of the transaction. The remainder of the trigger events and expected actions for both messages defined within the transaction as well as the message semantics associated with the ‘Receive Scheduled MWL’ message remain unchanged. Only the changed requirements are described in the following subsections

575 **4.12.1 Query Scheduled MWL Message – Enhanced Message Semantics**

The Acquisition Modality uses the C-FIND Request of the DICOM Modality Worklist SOP Class to query for the worklist from the DSS/Order Filler. The Acquisition Modality performs the SCU role and the DSS/Order Filler the SCP role.

580 Acquisition Modalities shall support individually each one of the required query keys listed in Table 4.12-3 - Matching and Return Keys for Enhanced Modality Worklist. Acquisition Modalities must support the Broad Query. In addition, Acquisition Modalities may optionally support the Patient Based Query.

The bold items in the following two tables are those included in addition to those defined in the baseline Query Modality Worklist (RAD-5) Transaction.

585 **1. The Patient Based Query:** Query for a worklist specific for a particular patient. The SCU shall support all (31) combinations of the matching key attributes listed in table 4.12-1 by including 1 or more keys.

Table 4.12-1: MWL Keys for Query by Patient

Matching Key Attributes	Tag
Patient's Name	(0010,0010)
Patient ID	(0010,0020)
Accession Number	(0008,0050)
Requested Procedure ID	(0040,1001)
Admission ID	(0038,0010)

590

2. The Broad Query: Query for a broad worklist. The SCU shall support all (15) combinations of the matching key attributes listed in table 4.12-2 by including 1 or more keys.

Table 4.12-2: MWL Keys for Broad Worklist Queries

Matching Key Attributes	Tag
Scheduled Procedure Step Start Date	(0040,0002)
Modality	(0008,0060)
Scheduled Station AE Title	(0040,0001)
Scheduled Procedure Step Location	(0040,0011)

595

4.12.1.1 Examples for the Use of Matching Key Attributes

- Using the Modality, Scheduled Procedure Step Start Date, and Scheduled Procedure Step Location: query for all ECG procedures in my department that are scheduled for the date specified.

- 600 • Using the Modality key: query for all the procedures that are scheduled on this type of modality (e.g., all ECG exams).
- Using Scheduled Station AE Title key: query for all the procedures that are scheduled on the modality with the specified AE Title.
- 605 • Using the Scheduled Procedure Step Start Date and Modality keys: query for all the CT procedures that are scheduled for today.
- Using the Patient Name or Patient ID: query for all the procedures that are scheduled for a patient.
- Using Admission ID: patients are often identified by their admission ID rather than their permanent MRN. These are often on patient ID bracelets in addition to, or instead of
- 610 the MRN.
- Using Accession Number: query for the requested procedure with the specified accession number.

Note: DICOM defines that dates and times are matched by their meaning, not as literal strings. If an application is concerned about how a single value matching of dates and times is performed by another application, it may consider using range matching instead (e.g., "<today>-<today>"), which is always performed by meaning.

Note: Applications are recommended to append a wildcard "*", if one was not previously entered by the user, at the end of each component of the structured Patient Name.

4.12.1.2 Matching Keys and Return Keys for Enhanced Modality Worklist

620 Table 4.12-3 summarizes the matching key requirements and lists the optional and required attributes that may be requested and is expected to be returned in order to make these available to the user at the Acquisition Modality. The only requirements that differ from those in the baseline "Query Modality Worklist" (RAD-5) Transaction are associated with the Scheduled Procedure Step Location and Admission ID attributes.

625 See section 2.2 "DICOM Usage Conventions" for more information on the requirements expressed in this table. All display requirements are an addition to the DICOM Standard requirements for the Modality Worklist SOP Class.

Table 4.12-3: Return and Matching Keys for Enhanced Modality Worklist

Attribute Name	Tag	Query Keys Matching		Query Keys Return	
		SCU	SCP	SCU	SCP
Scheduled Procedure Step					
Scheduled Procedure Step Sequence	(0040,0100)			[IHE-1]	[IHE-2]
>Scheduled Station AE Title	(0040,0001)	R+	R	R+*	R
>Scheduled Procedure Step Start Date	(0040,0002)	R+	R	R+	R
>Scheduled Procedure Step Start Time	(0040,0003)	O	R	R+	R

IHE Cardiology Technical Framework Supplement – Resting ECG Workflow (REWF)

Attribute Name	Tag	Query Keys Matching		Query Keys Return	
		SCU	SCP	SCU	SCP
> Scheduled Procedure Step Location [IHE-4]	(0040,0011)	R+ (Note 2)	R+ (Note 2)	R+	R+
>Modality	(0008,0060)	R+	R	R+	R
>Scheduled Performing Physician's Name	(0040,0006)	O	R	O	R
>Scheduled Procedure Step ID	(0040,0009)	O	O	R+*	R
>Scheduled Protocol Code Sequence	(0040,0008)				
>>Code Value	(0008,0100)	O	O	R+*	R
>>Coding Scheme Version	(0008,0103)	O	O	O	O
>>Coding Scheme Designator	(0008,0102)	O	O	R+*	R
>>Code Meaning	(0008,0104)	O	O	R+	R+
>Scheduled Procedure Step Description	(0040,0007)	O	O	R+	R
Requested Procedure					
Requested Procedure Comments	(0040,1400)	O	O	O	O
Requested Procedure Description	(0032,1060)	O	O	R+	R
Requested Procedure Code Sequence	(0032,1064)				
>Code Value	(0008,0100)	O	O	R+*	R
>Coding Scheme Version	(0008,0103)	O	O	O	O
>Coding Scheme Designator	(0008,0102)	O	O	R+*	R
>Code Meaning	(0008,0104)	O	O	R+	R+
Requested Procedure ID	(0040,1001)	R+ (Note 1)	R+ (Note 1)	R+	R
Names of Intended recipients of results	(0040,1010)	O	O	O	O
Study Instance UID	(0020,000D)	O	O	R+*	R
Referenced Study Sequence [IHE-3]	(0008,1110)				
>Referenced SOP Class UID	(0008,1150)	O	O	R+*	R
>Referenced SOP Instance UID	(0008,1155)	O	O	R+*	R
Imaging Service Request					
Imaging Service Request Comments	(0040,2400)	O	O	O	O
Accession Number	(0008,0050)	R+ (Note 1)	R+ (Note 1)	R+	R+ [IHE-3]
Requesting Physician	(0032,1032)	O	O	O	R
Requesting Service	(0032,1033)	O	O	O	O
Referring Physician's Name	(0008,0090)	O	O	R+	R
Visit Identification					

Attribute Name	Tag	Query Keys Matching		Query Keys Return	
		SCU	SCP	SCU	SCP
Admission ID [IHE-4]	(0038,00100)	R+	R+	R+	R
Visit Status					
Current Patient Location	(0038,0300)	O	O	O	R
Visit Relationship					
Referenced Patient Sequence	(0008,1120)				
>Referenced SOP Class UID	(0008,1150)	O	O	O	R
>Referenced SOP Instance UID	(0008,1155)	O	O	O	R
Patient Identification					
Patient's Name	(0010,0010)	R+	R	R+	R
Patient ID	(0010,0020)	R+	R	R+	R
Other Patient ID's	(0010,1000)	O	O	O	O
Patient Demographic					
Patients Birth Date	(0010,0030)	O	O	R+	R
Patient's Sex	(0010,0040)	O	O	R+	R
Confidentiality constraint on patient data	(0040,3001)	O	O	O	R
Ethnic Group	(0010,2160)	O	O	O	O
Patient Comment	(0010,4000)	O	O	O	O
Patient Medical					
Patient State	(0038,0500)	O	O	O	R
Pregnancy Status	(0010,21C0)	O	O	O	R
Medical Alerts	(0010,2000)	O	O	O	R
Additional Patient History	(0010,21B0)	O	O	O	O
Contrast Allergies	(0010,2110)	O	O	O	R
Patient Weight	(0010,1030)	O	O	O	R
Special Needs	(0038,0050)	O	O	O	R

Notes:

630

1. The matching performed by the SCP for the Requested Procedure ID and Accession Number attributes shall be single value (SV) matching.
2. The matching performed by the SCP for the Scheduled Procedure Step Location attributes shall support wild card (WC) matching.

635

(IHE-1): SCU implementations may choose to obtain the values contained in attributes that are part of the Scheduled Procedure Step sequence in either one of three ways. The first one is to request a universal match on the sequence attribute (zero length attribute). The second one is a universal sequence match (zero length item) for all attributes of the Scheduled Procedure Step sequence. The third one is to request a universal attribute match for selected attributes contained

640

in the Scheduled Procedure Step sequence.

645 (IHE-2): SCP implementations shall support, per the DICOM Standard, three ways to let the Query SCU obtain the values contained in attributes that are part of the Scheduled Procedure Step sequence. The first one is to support a universal match on the sequence attribute (zero length attribute), and all managed attributes will be returned. The second one is to support a universal sequence match (zero length item) for all attributes of the Scheduled Procedure Step sequence, and all managed attributes will be returned. The third one is to support a universal attribute match for selected attributes contained in the Scheduled Procedure Step sequence, and the managed attributes that were selected will be returned.

650 (IHE-3): A value (Non empty field) shall be returned in the Accession Number attribute if the field was requested by the MWL SCU.

655 (IHE-4): The Scheduled Procedure Step Location attribute is completely optional in the RAD-5 transaction. The Scheduled Procedure Step Location in this transaction shall be supported as both a return and matching key by both the SCU and the SCP. The RAD-5 transaction only requires that the Admission ID attribute be supported as a return key by the SCP. The Admission ID in this transaction shall also be supported as a return key by the SCU and as a matching key by both the SCU and SCP.

Add NEW Transaction, section 4.13 to Volume 2

660 **4.13 Query Cardiology Images/ Evidence [CARD-13]**

This transaction [CARD-13] is based upon the Query Images [RAD-14] and Query Evidence [RAD-44] Transactions (see RAD TF-2: 4.14 and RAD TF-2: 4.44), with several additional query return keys that are required to be supported as part of the Message Semantics section portion of the ‘Query Images’ message specification of the transaction. A Report Creator Actor is added as a participant in this transaction, fulfilling the same role as the Image Display Actor (query SCU).

665

The remainder of the trigger events, referenced standards and expected actions for the message defined within the transaction remain unchanged from the “parent” transactions (RAD-14 & RAD-44). Only the changed requirements are described in the following subsections.

670 **4.13.1 Use Case Roles**

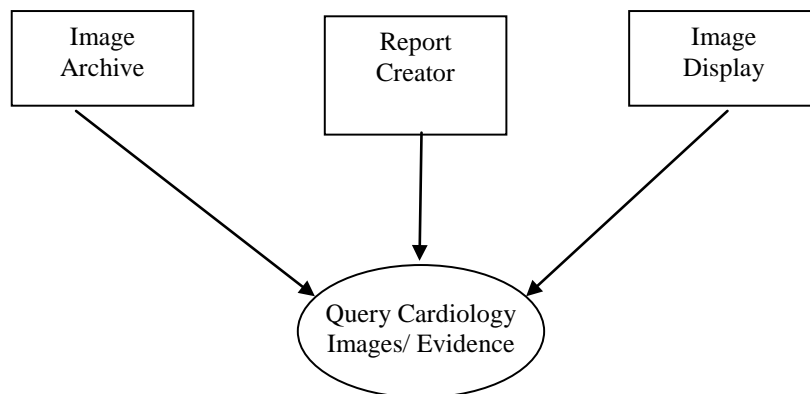

Actor: Image Archive

Role: Responds to queries for Studies, Series, and Images.

Actor: Image Display

675 **Role:** Issues Queries for Studies, Series, Images, Waveforms

Actor: Report Creator

Role: Issues Queries for Studies, Series, Images, Waveforms

4.13.2 Interaction Diagram

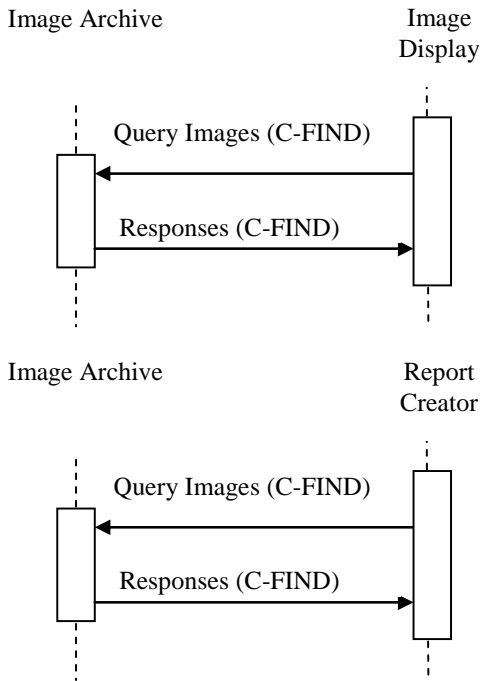

680

4.13.3 Message Semantics – Query Images – Resting ECG Workflow Profile Query Requirements

In addition to the required and unique keys defined by the DICOM Standard, the IHE Technical Framework has defined matching and return keys to be supported by query SCUs and SCPs. The conventions for key usage are defined in RAD TF-2: 2.2. The keys required by the behavior of the baseline transaction (RAD-14) are defined in table 4.14-1 in RAD TF-2: 4.14.4.1.2. This derived transaction places additional requirements on the Image Display, Report Creator (SCU) and the Image Archive (SCP) Actors for the return and matching keys within the context of the Resting ECG Workflow Profile. These additional requirements are defined in table 4.13-1.

690

Table 4.13-1: Return and Matching Keys for Resting ECG Workflow

Attribute Name	Tag	Query Keys Matching		Query Keys Return	
		SCU	SCP	SCU	SCP
Series Level					
Performed Protocol Code Sequence	(0040,0260)				
>Code Value	(0008,0100)	O	O	R+*	R+
>Coding Scheme Version	(0008,0103)	O	O	O	O
>Coding Scheme Designator	(0008,0102)	O	O	R+*	R+
>Code Meaning	(0008,0104)	O	O	R+	R+

Update Volume 2, Appendix A as follows:

Appendix A: Clarification on MPPS for Intermittently Connected Modality

695 When an Acquisition Modality (**or an Evidence Creator grouped with an Acquisition Modality**) is only intermittently connected to the network, in particular when it is not connected during the performance of a procedure, it may not be able to send Modality Procedure Step In Progress [CARD-1 and RAD-6], **Creator Procedure Step Completed [RAD-21]** and Modality Procedure Step Completed [RAD-7] transactions in real time.

700 The trigger events for these transactions (user begins or completes a procedure step) remain the same as specified in those transaction definitions, but the message remains queued for transmission until the modality reconnects to the network.

The Acquisition Modality **or Evidence Creator** shall send both an MPPS N-CREATE (with status IN PROGRESS) and an MPPS N-SET (with status COMPLETED or DISCONTINUED) message. The Acquisition Modality **or Evidence Creator** shall not send the MPPS N-SET until it receives a response from the Performed Procedure Step Manager for the MPPS N-CREATE.

710 The expected actions of the Performed Procedure Step Manager, DSS/OF, and Image Manager are the same as specified in the Modality Procedure Step In Progress, **Creator Procedure Step Completed** and Modality Procedure Step Completed transaction definitions.