

Integrating the Healthcare Enterprise



5

**IHE Cardiology
Technical Framework Supplement**

10

**Displayable Reports
(DRPT)**

**(Second Major Revision
incorporating CDA reports)**

15

Trial Implementation

20 Date: August 29, 2013
Author: IHE Cardiology Technical Committee
Email: cardio@ihe.net

Foreword

25 This is a supplement to the IHE Cardiology Technical Framework 5.0. Each supplement undergoes a process of public comment and trial implementation before being incorporated into the volumes of the Technical Frameworks.

This supplement is submitted for trial implementation as of August 29, 2013 and may be available for testing at subsequent IHE Connectathons. The supplement may be amended based on the results of testing. Following successful testing it will be incorporated into the Cardiology Technical Framework. Comments are invited and may be submitted at http://www.ihe.net/Cardiology_Public_Comments.

30 This supplement describes changes to the existing technical framework documents and where indicated amends text by addition (**bold underline**) or removal (**~~bold strikethrough~~**), as well as addition of large new sections introduced by editor’s instructions to “add new text” or similar, which for readability are not bolded or underlined.

35 “Boxed” instructions like the sample below indicate to the Volume Editor how to integrate the relevant section(s) into the relevant Technical Framework volume:

40

<i>Replace section X.X by the following:</i>
--

General information about IHE can be found at: www.ihe.net.

Information about the IHE Cardiology domain can be found at: http://www.ihe.net/IHE_Domains.

45 Information about the organization of IHE Technical Frameworks and Supplements and the process used to create them can be found at: http://www.ihe.net/IHE_Process and <http://www.ihe.net/Profiles>.

The current version of the IHE Cardiology Technical Framework can be found at: http://www.ihe.net/Technical_Frameworks.

50

CONTENTS

	Introduction.....	6
	Selection of a Standard in the First Revision.....	7
55	Selection of a Standard in the Second Revision.....	8
	Closed Issues.....	8
	Volume 1 – Integration Profiles.....	10
	1.7 IHE Cardiology Current Year Scope.....	10
	1.9 Copyright Permission.....	11
60	1.10 Patent Disclaimer.....	11
	2.2.4 Displayable Reports (DRPT).....	11
	6.0 Displayable Reports (DRPT).....	15
	6.1 Actors/Transactions.....	15
	6.1.1 Actor Groupings.....	17
65	6.1.1.1 Report Repository.....	17
	6.1.1.2 Integrated Report Manager / Repository.....	17
	6.2 DRPT Integration Profile Options.....	17
	6.2.1 Encapsulated Reports and By-Reference Reports Options.....	18
	6.3 Process Flow.....	18
70	6.4 Use Cases.....	20
	6.5 Relationship to Content Profiles.....	22
	Appendix Y: Displayable Report Distribution Using the DRPT, RID and XDS Profiles.....	23
	Y.1 Three Repositories.....	23
	Y.2 Two Repositories – Distributed Enterprise Storage.....	24
75	Y.3 Two Repositories – Distributed Enterprise Storage, No DICOM Access.....	25
	Y.4 Two Repositories – Distributed Cross-Enterprise Storage.....	26
	Appendix Z: Displayable Report Signing.....	27
	Volume 2 – Transactions.....	29
	4.7 Encapsulated Report Submission [CARD-7].....	29
80	4.7.1 Scope.....	29
	4.7.2 Use Case Roles.....	29
	4.7.3 Referenced Standards.....	29
	4.7.4 Interaction Diagram.....	30
	4.7.4.1 Encapsulated Report Submission.....	30
85	4.7.4.1.1 Trigger Events.....	30
	4.7.4.1.2 Message Semantics.....	30
	4.7.4.1.2.1 MSH Segment.....	31
	4.7.4.1.2.2 EVN Segment.....	32
	4.7.4.1.2.3 PID and PV1 Segments.....	32
90	4.7.4.1.2.4 ORC Segment.....	33
	4.7.5.1.2.5 OBR Segment.....	33
	4.7.4.1.2.6 TXA Segment.....	34
	4.7.4.1.2.7 OBX for Study Instance UID.....	36

	4.7.4.1.2.8 OBX for Encapsulated Report	36
95	4.7.4.1.2.9 Additional OBX Segments	38
	4.7.4.1.3 Expected Actions	38
	4.7.4.2 Encapsulated Report Update	39
	4.7.4.2.1 Trigger Events.....	40
	4.7.4.2.2 Message Semantics	40
100	4.7.4.2.2.1 MSH Segment.....	40
	4.7.4.2.2.2 TXA Segment	40
	4.7.4.2.3 Expected Actions	41
	4.7.4.3 Encapsulated Report Submission to Enterprise.....	41
	4.7.4.3.1 Trigger Events.....	41
105	4.7.4.3.2 Message Semantics	41
	4.7.4.3.2.1 ORC, OBR, and TXA Segments	42
	4.7.4.3.2.2 OBX for Study Instance UID	42
	4.7.4.3.3 Expected Actions	42
	4.7.4.4 Encapsulated Report Update Submission to Enterprise	42
110	4.7.4.4.1 Trigger Events.....	42
	4.7.4.4.2 Message Semantics	42
	4.7.4.4.3 Expected Actions	43
	4.8 Report Reference Submission [CARD-8].....	43
	4.8.1 Scope.....	43
115	4.8.2 Use Case Roles	43
	4.8.3 Referenced Standards	43
	4.8.4 Interaction Diagram	43
	4.8.4.1 Report Reference Initial Submission.....	44
	4.8.4.1.1 Trigger Event	44
120	4.8.4.1.2 Message Semantics	45
	4.8.4.1.2.1 TXA Segment	45
	4.8.4.1.2.2 OBX Segment.....	46
	4.8.4.1.3 Expected Actions	46
	4.8.4.2 Report Reference Update Submission.....	47
125	4.8.4.2.1 Trigger Event	47
	4.8.4.2.2 Message Semantics	47
	4.8.4.2.2.1 TXA Segment	47
	4.8.4.2.3 Expected Actions	48
	4.9 Encapsulated Report Storage [CARD-9].....	48
130	4.9.1 Scope.....	48
	4.9.2 Use Case Roles	49
	4.9.3 Referenced Standards	49
	4.9.4 Interaction Diagram	49
	4.9.4.1 Report Storage	49
135	4.9.4.1.1 Trigger Events.....	50
	4.9.4.1.2 Message Semantics	50
	4.9.4.1.3 Expected Actions	52

	4.10 Encapsulated Report Query [CARD-10]	53
	4.10.1 Scope	53
140	4.10.2 Use Case Roles	53
	4.10.3 Referenced Standards	53
	4.10.4 Interaction Diagram	53
	4.10.4.1 Query Reports	54
	4.10.4.1.1 Trigger Events	54
145	4.10.4.1.2 Message Semantics	54
	4.10.4.1.3 Expected Actions	55
	4.11 Encapsulated Report Retrieve [CARD-11]	56
	4.11.1 Scope	56
	4.11.2 Use Case Roles	56
150	4.11.3 Referenced Standards	56
	4.11.4 Interaction Diagram	57
	4.11.4.1 Retrieve Reports	57
	4.11.4.1.1 Trigger Events	57
	4.11.4.1.2 Message Semantics	57
155	4.11.4.1.3 Expected Actions	57
	4.11.4.2 View Reports	58
	4.11.4.2.1 Trigger Events	58
	4.11.4.2.2 Invocation Semantics	58
	4.11.4.2.3 Expected Actions	58
160	Appendix D: Coded Report Titles	59

Introduction

165 This Supplement adds a profile to the IHE Cardiology Technical Framework describing a means to distribute “display ready” clinical reports from a creating application, to the department, to the enterprise, and beyond. It covers the workflow in production, release, and distribution of report documents.

170 Note that “documents” are distinguished from “results”. Documents have properties of persistence, stewardship, potential for authentication, context, wholeness, and human readability¹ that may not apply to results (such as lab results).

175 The specification of this Profile in the IHE Cardiology Technical Framework should not be viewed as limiting its application in other clinical domains. It is potentially applicable to all domains that involve imaging, including radiology, oncology, obstetrics/gynecology, gastroenterology, ophthalmology, and orthopedics.

180 This Displayable Reports Integration Profile (DRPT) was originally published as a 2005 Supplement to the IHE Cardiology Technical Framework, specifying the use of PDF documents for the reports. During the Trial Implementation period of June 2005 through March 2006, inconsistencies were noted between the Profile and current understandings for the use of the HL7 Standard. Indeed, finding such inconsistencies is precisely the point of the Trial Implementation period. Therefore, the IHE Cardiology Technical Committee reissued the Supplement in 2008 with major technical corrections to the use of HL7 in DRPT Profile.

185 In the years since 2005, the HL7 Clinical Document Architecture (CDA) has emerged as a consensus format for a wide variety of clinical reports; for example, the majority of profiles of the IHE Patient Care Coordination Domain are based on CDA. In 2009, the IHE Cardiology Domain began work on Content Profile for cardiac imaging reports similarly based on CDA. In order to support the creation and management of these CDA reports, a second major revision to the DPRT Trial Implementation version was developed.

190 This second revision also adds clarifications to better support the use of the Profile for ECG reporting, and restructures the actors to avoid the use of options.

195 Because this reissued Supplement introduces substantive changes to the Profile’s Transactions, developers and users are cautioned that the DRPT Profile Connectathon results for the years that the Trial Implementation versions of the Profile have been tested may not be compatible with each other, or with results using the eventual Final Text version. It is important to note the following statement in the IHE Cardiology Technical Framework (CARD TF-1: 1.10.3):

Products implemented based on Trial Implementation text are expected to review the subsequent Final Text and update their products as necessary.

¹ HL7 v3 Clinical Document Architecture Release 2.0, Section 1.1

Selection of a Standard in the First Revision

200 The 2005-2006 Trial Implementation version of this Profile specified that PDF formatted reports would be exchanged using the HL7 v2.3.1 ORU (unsolicited observation) message. However, new in the HL7 v2.5 standard was this language:

If the observation being reported meets one or more of the following criteria, then the content would qualify as a medical document management message (MDM) rather than an observation message (ORU). The reader is referred to the MDM message type in Chapter 9.

- 205
- *Documents/reports that require succession management to reflect the evolution of both document addenda and replacement documents. Document succession management is described in HL7 v2.5 section 9.6.1.17.*
 - *Documents/reports where the Sender wants to indicate the availability of the report for use in patient care using the availability status present in the TXA segment, as described in Chapter 9.*
- 210

...

Using these criteria, the following examples of documents/reports would typically qualify as medical document management (MDM) messages. Note that as clinical content, the following documents/reports typically require succession management and/or report availability, thus would require an MDM message even if the payload utilizes CDA.

- 215
- *History and Physical*
 - *Consultation reports*
 - *Discharge summaries*
 - *Surgical/anatomic pathology reports*
- 220
- *Diagnostic imaging reports*
 - *Cardio-diagnostic reports*
 - *Operative reports*

It was therefore a fundamental error to use ORU rather than MDM for the purposes of this Profile. And, in fact, there were also technical deficiencies with the use of ORU in regard to report document identifiers and document succession. This revised Profile therefore uses the MDM message, which is similar to the ORU, but adds a TXA segment.

225

A second major issue with the 2005-2006 Trial Implementation version of this Profile was the absence of a use case and mechanism for demographic updates to be applied to documents in the repository. The revised DRPT Profile therefore requires the Report Repository actor to receive demographic update transactions.

230

Finally, PDF in its native form cannot guarantee long-term reproducibility of stored documents, therefore recent initiatives to define the format of long term storage of PDF documents has led to a new Standard governing electronic document archiving:

235 ISO-19005-1 - Document management - Electronic document file format for long-term preservation - Part 1: Use of PDF 1.4 (PDF/A-1). This format supports a wide variety of content like text, images, graphics, fonts, color information and much more used in creation of clinical reports. This revised profile therefore requires the use of the new PDF/A format for the transactions in this profile.

Selection of a Standard in the Second Revision

240 The 2005 and 2007 Trial Implementation versions of this Profile specified that PDF is the only allowed format for reports to be exchanged. However, CDA has emerged as a consensus format for reports for patient care coordination, and is used extensively in IHE Profiles. In fact, an IHE Profile for a Cardiac Imaging Report using CDA is in development. DICOM Supplement 114
245 added an Encapsulated CDA information object definition to the DICOM Standard. This revised profile therefore allows the use of either PDF or CDA format for the transactions in this profile. Receivers are expected to be able to support and display both formats.

This revision also updates the version of HL7 used for MDM messages to v2.6. The prior revision used v2.5, but “pre-adopted” the changes to the ED data type that had been approved by the HL7 Orders and Observations Technical Committee for v2.6. Since v2.6 has been published,
250 this Supplement uses the most current version.

Closed Issues

1. The scope of the profile includes a Report Repository that is responsible for long-term storage of the report *within the department*. Architectures that use only an Enterprise Report Repository and not any departmental long term storage are not covered by this
255 profile.
2. There are two options for the departmental long term Report Repository: an Integrated Report Manager/Repository can manage the storage itself, or a Report Manager can use the capabilities of a DICOM Repository (i.e., PACS).
3. The Report Repository in this profile must support RID Profile HTTP access to reports. It
260 may also support DICOM Q/R access.
4. The same transaction (CARD-7) is used between the Report Creator and the Report Manager, and between the Report Manager and the Enterprise Report Repository. A Report Creator that supports this profile could thus be hooked directly to such an Enterprise Report Repository (outside the scope of this profile).
- 265 5. The Enterprise Report Repository does not need to be broken up into two actors (Enterprise Report Registry and Enterprise Report Repository) for the two types of messages that will be sent to this actor.
6. There does not need to be an optional DICOM based encapsulated document transaction from the Report Creator to the Report Manager. This may be included in a revision to the
270 SINR profile, which has been discussed with the Radiology Technical Committee.

7. The Study Instance UID in an HL7 encapsulation uses an OBX segment (as done in the SINR profile), not the ZDS segment (as done in the SWF profile).
8. The departmental Report Repository is required to be grouped with the Information Source actor of the RID Profile.
- 275 9. HL7 Application-level acknowledgements are not necessary from the Report Manager or the Enterprise Report Repository.
10. It is appropriate to require the ITI-12 (RID) format for URLs; arbitrary application-defined URLs are not allowed in this Profile. Note that the ITI-12 transaction specifies some desirable behavior on the part of the actors.
- 280 11. If the Report Creator and the Report Manager are grouped in a product implementation, that grouping must support the CARD-7 transaction from other Report Creators.
12. It is optional to support query by document title as a matching key for SCP implementation
- 285 13. Valid DICOM identifier are required as the document unique identifier by the report creator for TXA-12
14. Specification of HL7 messages have been updated in the Trial Implementation version to use the current HL7 message profiling style.
15. Use of Stylesheets is described in PCC-TF-2: 6.3.1.1.4 and additional notes are in sections 4.7.4.1.2.8 and 4.11.4.2.3 of this Supplement.
- 290 16. There is no DRPT use case for a “submission set” of multiple documents, such as is used in the XDS Profile, nor for a separate signature document that applies a digital signature to another document by reference, such as is used in the DSG Profile.
- 295 17. For Trial Implementation, the Report Repository uses the IHE Radiology Patient Update transaction [RAD-12] for demographics updates to archived data. Before Final Text, the IHE Cardiology Technical Committee will reevaluate using the Patient Identity Feed transaction [ITI-30] of the Patient Administration Management Profile.
- 300 18. The Profile includes a table to link report types as sent in the MDM TXA-2 field to RID summary classes (see 4.7.4.1.2.6). DICOM CP1078 provides a mechanism for conveying the TXA-2 value in the DICOM encapsulated report instances, so that the Report Repository can respond appropriately to RID queries.

Volume 1 – Integration Profiles

305 Add the following bullet in section 1.7

1.7 IHE Cardiology Current Year Scope

...

- 310 • The Displayable Reports Profile describes mechanisms for the transmission of PDF- or CDA-formatted clinical reports between report creators, managers, repositories, and displays. This profile describes the departmental production of reports, which can be further distributed using the Retrieve Information for Display and Cross-Enterprise Document Sharing Profiles (defined in the IHE IT Infrastructure Domain).

Add the following dependencies in section 2.1

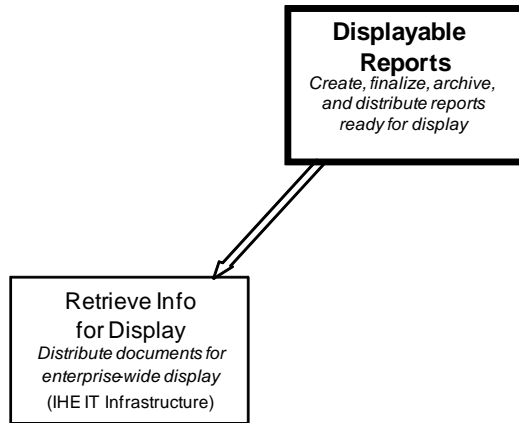

315

Figure 2-1: IHE Cardiology Integration Profiles and Dependencies

Table 2-1: Cardiology Integration Profiles Dependencies

Integration Profile	Depends on	Dependency Type	Comments
...			
Displayable Reports	ITI-TF Retrieve Info for Display	The Report Repository actor is required to be grouped with Information Source actor of RID	

320 The following section is reproduced here from the Technical Framework for legal reasons.

1.9 Copyright Permission

Health Level Seven, Inc., has granted permission to the IHE to reproduce tables from the HL7 standard. The HL7 tables in this document are copyrighted by Health Level Seven, Inc. All rights reserved.

325 The National Electrical Manufacturers Association (NEMA) has granted permission to the IHE to incorporate portions of the DICOM standard.

Material drawn from these documents is credited where used.

330 *Add the following subsection to the Technical Framework and renumber any subsequent subsections on section 1.*

1.10 Patent Disclaimer

Attention is called to the possibility that implementation of the specifications in this document may require use of subject matter covered by patent rights. By publication of this document, no position is taken with respect to the existence or validity of any patent rights in connection therewith. IHE International is not responsible for identifying Necessary Patent Claims for which a license may be required, for conducting inquiries into the legal validity or scope of Patents Claims or determining whether any licensing terms or conditions provided in connection with submission of a Letter of Assurance, if any, or in any licensing agreements are reasonable or non-discriminatory. Users of the specifications in this document are expressly advised that determination of the validity of any patent rights, and the risk of infringement of such rights, is entirely their own responsibility. Further information about the IHE International patent disclosure process including links to forms for making disclosures is available at http://www.ihe.net/Patent_Disclosure_Process. Please address questions about the patent disclosure process to the secretary of the IHE International Board: secretary@ihe.net.

345

Add the following summary section 2.2.4

2.2.4 Displayable Reports (DRPT)

350 The Displayable Reports Profile specifies transactions supporting the creation, revision, intra/inter-department transmission, and reading of display-ready clinical reports. In the imaging procedure context, it provides linkage between the report, the imaging and other evidence of the procedure. The report is provided to actors outside the department for broad distribution (e.g., using other profiles).

355 The DRPT Profile requires the use of the Portable Document Format (PDF) or the HL7 Clinical Document Architecture (CDA), which are both means of encoding documents ready for presentation, including graphical content. For reporting on imaging procedures, especially on

cardiac procedures, they are able to present the full range of documentation generated by a wide variety of reporting packages.

Add the following Actors to the list in section 2.3

- 360 **Report Creator** – A system that generates and transmits clinical reports.
- Report Manager** – A system that manages the status of reporting, and distributes reports to report repositories.
- Report Reader** – A system that can query/retrieve and view reports encoded as DICOM objects.
- 365 **Report Repository** – A departmental system that receives reports and stores them for long-term access.
- Integrated Report Manager/Repository** – A system that manages the status of reporting, and additionally maintains an internal report repository.
- 370 **Enterprise Report Repository** – A system that receives reports and/or references to reports, and stores them for long-term access throughout the healthcare enterprise

Add the following Actors to the table in section 2.3

Table 2.3-1: Integration Profile Actors

Actor \ Integration Profile	CATH	ECHO	ECG	<u>DRPT</u>	ED
...					
Department System Scheduler/Order Filler	X	X		<u>X</u>	
...					
Report Creator				<u>X</u>	X
<u>Report Manager</u>				<u>X</u>	
<u>Report Reader</u>				<u>X</u>	
<u>Report Repository</u>				<u>X</u>	
<u>Integrated Report Manager/Repository</u>				<u>X</u>	
<u>Enterprise Report Repository</u>				<u>X</u>	

375

Add the following Transactions to the list in section 2.4

Encapsulated Report Submission – A Report Creator sends a preliminary, final, or corrected final clinical report to the Report Manager. [CARD-7]

380 **Report Reference Submission** – A Report Manager sends a reference to a report to the Enterprise Report Repository for storage. [CARD-8]

Encapsulated Report Storage – A Report Manager sends a preliminary, final, or corrected final clinical report to the Report Repository. [CARD-9]

385 **Encapsulated Report Query** – A Report Reader requests a list of clinical reports known by the Report Repository matching a set of selection criteria. [CARD-10]

Encapsulated Report Retrieve – A Report Reader requests and retrieves a clinical report from the Report Repository. [CARD-11]

Add the following Transactions to the table in section 2.4

390

Table 2.4-1: Integration Profile Transactions

Transaction	Integration Profile	...	<u>DRPT</u>
...			
Procedure Scheduled [RAD-4]			<u>X</u>
...			
Storage Commitment [CARD-3]			<u>X</u>
Patient Update [RAD-12]			<u>X</u>
Procedure Update [RAD-13]			<u>X</u>
...			
Maintain Time [ITI-1]			
Retrieve Specific Info for Display [ITI-11]			<u>(note 2)</u>
Retrieve ECG List [CARD-5]			<u>(note 2)</u>
Retrieve ECG Document for Display [CARD-6]			<u>(note 2)</u>
<u>Encapsulated Report Submission [CARD-7]</u>			<u>X</u>
<u>Report Reference Submission [CARD-8]</u>			<u>X</u>
<u>Encapsulated Report Storage [CARD-9]</u>			<u>X</u>
<u>Encapsulated Report Query [CARD-10]</u>			<u>X</u>
<u>Encapsulated Report Retrieve [CARD-11]</u>			<u>X</u>
<u>Retrieve Document for Display [ITI-12]</u>			<u>(note 2)</u>

Notes:

- 395
1. The Maintain Time transaction is not formally part of the Cath Workflow Profile, but it is required for the Time Client actor grouped with certain actors in that Profile.
 2. **This transaction is not formally part of the Displayable Reports Profile, but may be required for the Information Source actor grouped with the Report Repository actor in that Profile.**

Add the following grouping to the list in section 2.5

400 In general, a product implementation may incorporate any single actor or combination of actors.
However, in the cases specified below, the implementation of one actor requires the
implementation of one or more additional actors:

...

- 405 • **The Report Repository Actor and Integrated Report Manager/Repository Actor participating in Displayable Reports Integration Profile shall be grouped with the Information Source Actor of the Retrieve Information for Display Profile.**

When multiple actors are grouped in a single product implementation, all transactions originating or terminating with each of the supported actors shall be supported (i.e., the IHE transactions shall be offered on an external product interface). The exceptions to this rule are any transactions defined between actors in the required groupings defined above.

410

<i>Add the following new profile</i>

6.0 Displayable Reports (DRPT)

415 The Displayable Reports Profile specifies transactions supporting the creation, revision, intra/ inter-department transmission, and reading of display-ready clinical reports. In the imaging procedure context, it provides linkage between the report, the imaging and other evidence of the procedure. The report is provided to actors outside the department for broad distribution (e.g., using other profiles).

420 The DRPT Profile specifies use of the Portable Document Format (PDF) or the HL7 Clinical Document Architecture (CDA), which are both means of encoding documents ready for presentation, including graphical content. For reporting on imaging procedures, especially on cardiac procedures, they are able to present the full range of documentation generated by a wide variety of reporting packages.

425 This profile does not address a standardized Reporting Worklist Management function. In the context of reporting on cath lab and similar interventional procedures, there is often not a need for such Worklist management as reports are created by the performing physician immediately after the case. Those may be addressed in other profiles.

6.1 Actors/Transactions

430 Figure 6.1-1 diagrams the actors involved with this profile and the transactions between actors. The Retrieve Information for Display (RID) Profile actors are shown in gray, since the Report Repository actor in the DRPT profile must be grouped with the Information Source actor in the RID Profile (see sections 2.5 and 6.1.1.1).

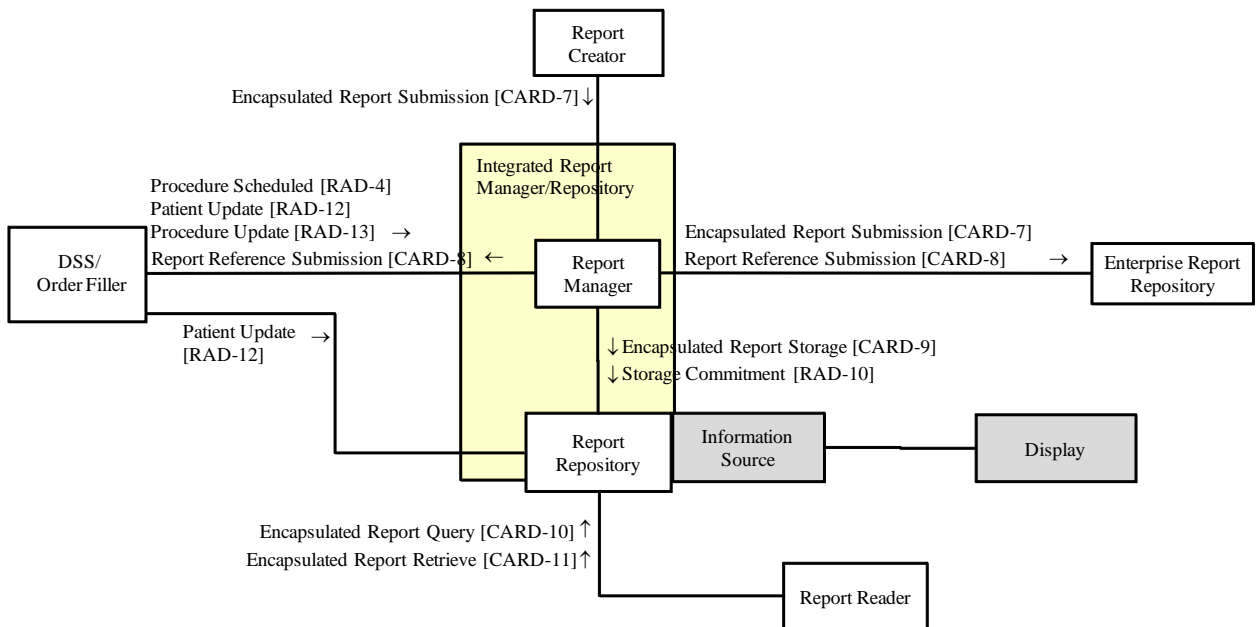

Figure 6.1-1: DRPT Profile Diagram, with RID Profile for Reference

435 Table 6.1-1 lists the transactions for each actor directly involved in the DRPT Integration Profile. In order to claim support of this Integration Profile, an implementation must perform the required Transactions (labeled “R”). Transactions labeled “O” are optional. A complete list of options defined by this Integration Profile that implementations may choose to support is listed in section 6.2.

440

Table 6.1-1 DRPT – Actors and Transactions

Actors	Transactions	Optionality	Section
Report Creator	Encapsulated Report Submission [CARD-7]	R	CARD-TF 2: 4.7
Report Manager	Encapsulated Report Submission [CARD-7]	R	CARD-TF 2: 4.7
	Report Reference Submission [CARD-8]	R	CARD-TF 2: 4.8
	Procedure Scheduled [RAD-4]	R	RAD-TF 2: 4.4
	Patient Update [RAD-12]	R	RAD-TF 2: 4.12
	Procedure Update [RAD-13]	R	RAD-TF 2: 4.13
	Encapsulated Report Storage [CARD-9]	R	CARD-TF 2: 4.8
	Storage Commitment [RAD-10]	R	RAD-TF 2: 4.10
Report Repository	Encapsulated Report Storage [CARD-9]	R	CARD-TF 2: 4.9
	Storage Commitment [RAD-10]	R	RAD-TF 2: 4.10
	Patient Update [RAD-12]	R	RAD-TF 2: 4.12
	Encapsulated Report Query [CARD-10]	R	CARD-TF 2: 4.10
	Encapsulated Report Retrieve [CARD-11]	R	CARD-TF 2: 4.11
Integrated Report Manager/Repository	Encapsulated Report Submission [CARD-7]	R	CARD-TF 2: 4.7
	Report Reference Submission [CARD-8]	R	CARD-TF 2: 4.8
	Procedure Scheduled [RAD-4] (as Report Manager)	R	RAD-TF 2: 4.4
	Patient Update [RAD-12] (as Report Manager)	R	RAD-TF 2: 4.12
	Procedure Update [RAD-13] (as Report Manager)	R	RAD-TF 2: 4.13
Enterprise Report Repository	Encapsulated Report Submission [CARD-7]	O (see note 1)	CARD-TF 2: 4.12
	Report Reference Submission [CARD-8]	O (see note 1)	CARD-TF 2: 4.8
Report Reader	Encapsulated Report Query [CARD-10]	R	CARD-TF 2: 4.10
	Encapsulated Report Retrieve [CARD-11]	R	CARD-TF 2: 4.11
Department System Scheduler/Order Filler	Report Reference Submission [CARD-8]	R	CARD-TF 2: 4.8
	Procedure Scheduled [RAD-4]	R	RAD-TF 2: 4.4
	Patient Update [RAD-12]	R	RAD-TF 2: 4.12
	Procedure Update [RAD-13]	R	RAD-TF 2: 4.13

Note: The Enterprise Report Repository is required to support one or both of the transactions defined for it; see 6.2 for options.

In each of the transactions assigned in table 6.1-1, actors shall implement the HL7 v2.5.1 Message Semantics when such semantics are defined. Those transactions are:

445

- Procedure Scheduled [RAD-4]
- Patient Update [RAD-12]

- Procedure Updated [RAD-13]

6.1.1 Actor Groupings

450 This section describes required grouping of defined actors within the DRPT Profile. (See also section 2.5 for discussion of grouping of actors in an implementation.)

6.1.1.1 Report Repository

The Report Repository shall be grouped with the Information Source actor of the ITI Retrieve Information for Display Profile.

6.1.1.2 Integrated Report Manager / Repository

455 The Integrated Report Manager/Repository Actor combines the functionality of the Report Manager and Report Repository actors into a single actor, but excluding all DICOM transactions. Thus it does not initiate nor accept the Encapsulated Report Storage [CARD-9] and Storage Commitment [CARD-10] transaction, which are internal to the combined actor. It does not support Encapsulated Report Query [CARD-10] and Retrieve [CARD-11] transactions.

460 Note: Installations desiring DICOM Query/Retrieve capability for report documents should utilize an implementation that claims conformance as a Report Repository actor.

This actor may replace the Report Manager actor from the perspective of the Procedure Scheduled [RAD-4], Patient Update [RAD-12], and Procedure Update [RAD-13] transactions.

465 The Integrated Report Manager/Repository shall be grouped with the Information Source actor of the ITI Retrieve Information for Display Profile.

6.2 DRPT Integration Profile Options

Some Actors have Options defined in order to accommodate variations in use across domains or implementations. Options that may be selected for this Integration Profile are listed in the table 6.2-1 along with the Actors to which they apply.

470

Table 6.2-1: DRPT – Actors and Options

Actor	Option Name	Optionality	Vol. & Section
Report Creator	<i>No options defined</i>	-	-
Report Manager	<i>No options defined</i>	-	-
Report Repository	<i>No options defined</i>	-	-
Integrated Report Manager/Repository	<i>No options defined</i>	-	-
Enterprise Report Repository	Encapsulated Reports	O (see 6.2.1)	CARD-TF 2: 4.7
	By-Reference Reports	O (see 6.2.1)	CARD-TF 2: 4.8
Report Reader	<i>No options defined</i>	-	-
Department System Scheduler/ Order Filler	<i>No options defined</i>	-	-

6.2.1 Encapsulated Reports and By-Reference Reports Options

475 This Profile allows two different architectures for report submissions to the Enterprise Report Repository actor. In one architecture, the Enterprise Report Repository receives the report document in the submission transaction. In the second architecture, the Enterprise Report Repository receives a reference to the report document in the submission transaction, and may later retrieve the document through another transaction.

The Enterprise Report Repository is required to support one or both of the Encapsulated Reports and By-Reference Reports options.

480 Note: The use of the By-Reference Reports Option may be necessary due to message size constraints on HL7 messages passing through interface engines to the Enterprise Report Repository.

6.3 Process Flow

The basic process flow for the DRPT Profile is shown in figure 6.3-1.

485 When a procedure or exam is ordered and scheduled, the Department System Scheduler/Order Filler informs the Report Manager using the Procedure Scheduled (RAD-4) transaction. This allows the Report Manager to keep track of orders being fulfilled, and match incoming reports to those orders. The DSS/OF also sends changes in the scheduled procedures using the Procedure Update (RAD-13) transaction.

490 Following the procedure or exam, the reporting clinician uses an application at the Report Creator to create a display-ready clinical report. This report may incorporate text, graphics such as coronary tree diagrams or wall motion scoring charts, embedded images, etc. The report may be unverified, preliminary, final, or a corrected final; if preliminary, final, or corrected final, it needs to be signed (using a mechanism not specified in this profile; see Appendix Z). The report is sent using the Encapsulated Report Submission [CARD-7] transaction to the Report Manager, 495 including an identifier for the Requested Procedure (i.e., a Study Instance UID).

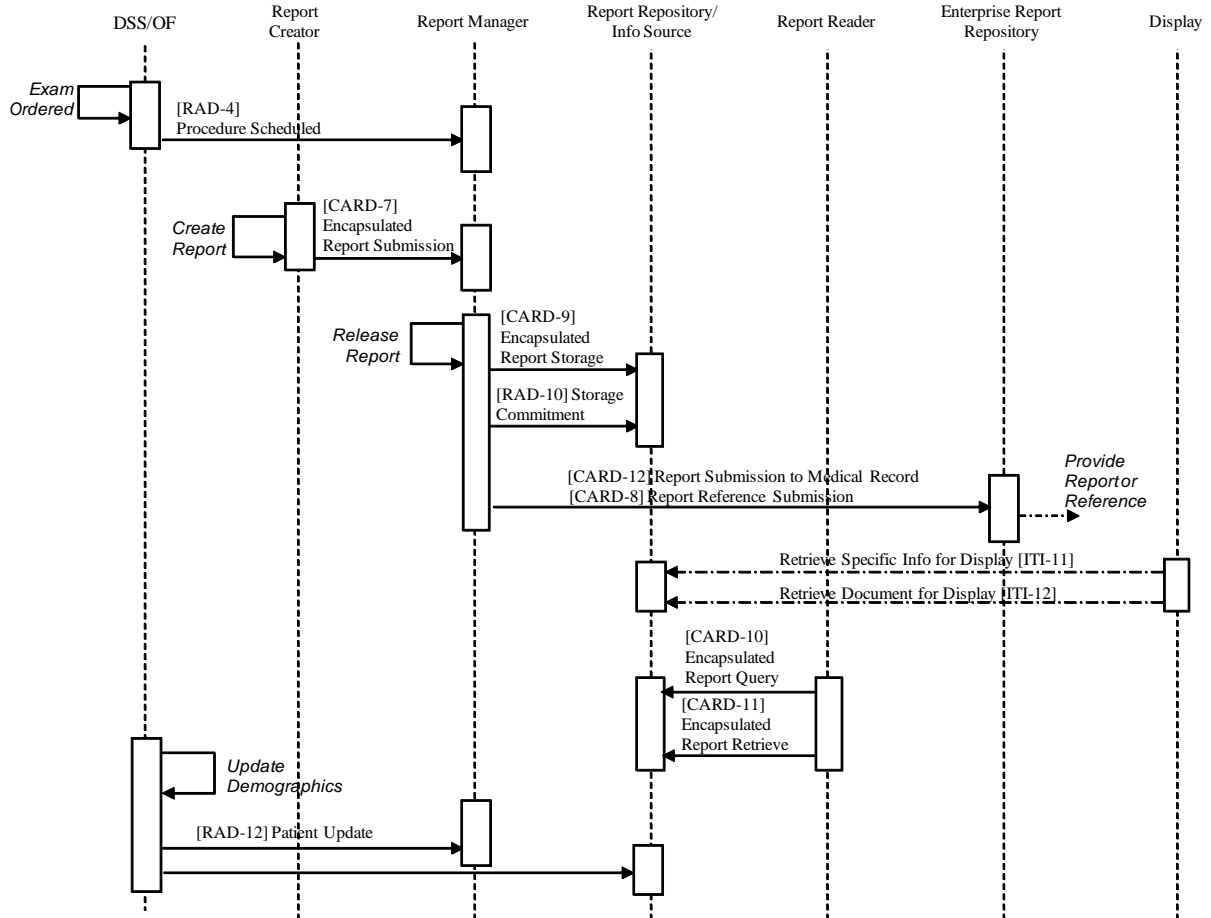

Figure 6.3-1: DRPT Process Flow

500 In this Profile the Report Manager may apply processing rules to reports, e.g., presentation of an unverified report to a user for verification or signature. The Report Manager is responsible for managing the status of reports and determining when a report is to be made available to the enterprise. The Report Manager may choose to change the status of a report from a Report Creator. When it has determined that the report is to be released, it stores the report in the departmental Report Repository.

505 The Report Manager may be implemented with a Report Repository (as an Integrated Report Manager/Repository actor), in which case the storage uses a proprietary mechanism. If the Report Manager uses a separate Report Repository actor, it re-encapsulates the report as a DICOM Encapsulated PDF or Encapsulated CDA object and sends it to the Report Repository.

510 When a report is released, which may be workflow dependent or automated, the Report Manager also forwards the report to the Enterprise Report Repository. The Enterprise Report Repository elects to receive the reports either encapsulated in the Report Submission [CARD-7] transaction, or by reference URL in the Report Reference Submission [CARD-8] transaction or both; the

Report Manager must support both transactions. The Enterprise Report Repository may be responsible for distribution of the report outside the department.

515 The department Report Repository is required to be grouped with the Information Source actor of the Retrieve Information for Display Profile, and as such provides access to stored reports for any Display actor using the Retrieve Specific Info for Display [ITI-11] and Retrieve Document for Display [ITI-12] transactions of the Retrieve Information for Display Profile. Additionally, if the Report Repository is a separate actor from the Report Manager, it also provides access using 520 DICOM Query/Retrieve functions through the Encapsulated Report Query [CARD-10] and Encapsulated Report Retrieve [CARD-11] transactions.

The department Report Repository is also required to receive patient demographic updates from the ADT using the Patient Update [RAD-12] transaction.

525 Notes: 1. The Report Creator may create an unverified, preliminary, final, or corrected final report. The Report Manager manages the release process for submitted reports, and may change an unverified or preliminary report to final. The Report Manager application-specific processing rules may dictate that some or all unverified or preliminary reports are made available to the enterprise, or that only final reports are made available.

530 2. The Report Manager creates a URL link to the report for the Report Reference Submission transaction. If the Report Manager is not integrated with the Report Repository, it needs to be configurable for the web service access point of the Report Repository as the target of the Retrieve Document for Display [ITI-12] transaction. It uses the encapsulated document Instance UID as the documentUID for the [ITI-12] transaction.

3. Distribution of the report outside the department by the system that incorporates the Enterprise Report Repository actor may use the RID Profile or the XDS Profile – see Appendix Y.

535 4. The DRPT profile does not specify the demographic updates for the Enterprise Report Repository. DRPT specifies only the demographic update for the departmental Report Repository.

540 5. The Report Manager may notify the Department System Scheduler/Order Filler of a signed report. This is a notification only, without the document itself, but with a report retrieval reference (to the Report Repository) in accordance with the RID Profile. The Department System Scheduler/Order Filler may use this information to determine when to send the ORM to the Order Placer with status “CM”. The Report Manager will not assert that neither the order nor the Requested Procedure is complete; that is a responsibility of the Department System Scheduler/Order Filler. In the case of an order that has multiple Requested Procedures, or that requires multiple reports for order completion (e.g., a stress test with ECG and imaging components separately read), the Department System Scheduler/Order Filler may be able to implement an automated process, but may require manual review of the reports to verify completion of all order requirements.. The Department System Scheduler/Order Filler is expected to participate in the order fulfillment aspect of a workflow function such as the 545 Radiology Scheduled Workflow, CATH, ECHO or STRESS Profiles

6.4 Use Cases

Case R1: Report manager provides local storage and distribution of reports

550 **Clinical Context:** A departmental report management system may have the capability to provide long-term storage of the report. The report management system will be used for distribution of the report to workstations both within and outside the department.

IHE Context: The Integrated Report Manager/Repository provides long-term storage of reports. These reports may be stored in proprietary formats.

555 The Integrated Report Manager/Repository / Information Source supports requests from workstations that implement the RID Display actor to access the reports using HTTP.

Case R2: Image manager/archive provides storage and distribution of reports

560 **Clinical Context:** A departmental report management system uses an existing PACS capability to provide long-term storage of the report. The PACS will be used for distribution of the report to workstations within and outside the department.

IHE Context: The Report Manager sends reports as DICOM objects to the PACS for long-term storage. The PACS acts as the Report Repository actor.

565 The PACS Report Repository will both support DICOM report queries, and be a RID Information Source for report requests using HTTP. Workstations may implement either the Report Reader actor using standard DICOM Q/R, or the RID Display actor to access the reports using HTTP.

Case R3: Multiple Reports on one Requested Procedure

Clinical Context: A common occurrence in cardiology is the use of procedures requiring multiple reports, potentially from different participating physicians.

570 One example is the exercise stress study with an imaging component. The stress component is interpreted by a physician, and the results reported. Similarly, the imaging component may be interpreted separately by a different physician. The reports must be distributed electronically to the referring physician.

575 Another example is a cardiac cath procedure where both diagnostic and interventional phases are completed, and reported on by different performing physicians.

580 **IHE Context:** One or more Report Creators may provide reports on the various individual components of the Requested Procedure. The Report Manager is required to support separate management of reports with different titles within a single Requested Procedure. The fact that IHE accommodates multiple reports within a single Requested Procedures mitigates the need to have multiple requested procedures (with the additional administrative overhead inherent in same) for a complex cardiology study.

585 The multiple reports in each of these cases are distinguished by their report titles, e.g., “Exercise Stress Test Report” and “Nuclear Stress Test Report” in the first example, or “Diagnostic Cardiac Catheterization Report” and “Interventional Cardiac Catheterization Report” in the second example.

Case R4: Unverified, Preliminary, Final and Corrected Final Reports

590 **Clinical Context:** Reporting workflow often requires multiple stages and contributors before a report is completed. In many cases there are valid clinical reasons to distribute the information in the report throughout the various stages, even though it is not “complete”, e.g., preliminary measurements without final interpretation. Furthermore even after “completion”, there may be valid reasons to update or otherwise correct the report and hence a need to re-issue it.

595 **IHE Context:** The Report Creator may create an unverified, preliminary, final, or corrected final report. In all cases the Report Manager manages the release process for submitted reports. The Report Manager typically will have application-specific processing rules dictating that some or all unverified or preliminary reports are made available to the enterprise, or that only finalized reports are made available. There is a dedicated report-status flag in the HL7 MDM Encapsulated Report Submission and Report Reference Submission messages to facilitate management and query/retrieval of reports based on status.

600 Each intermediate report product will have its own unique object identifier, so that it can be individually accessed.

Case R5: Demographic Update to Stored Reports

605 **Clinical Context:** After a report has been created, verified, signed and released, the patient registration application/patient identity source may send a demographic data update or may send data that would change patient identifiers for the patient whose report has been finalized. This necessitates a mechanism to support demographic information and patient identifier updates for patients for whom reports have been created and stored.

610 **IHE Context:** The department Report Repository is required to support the Patient Update transaction. If the ADT actor sends a patient merge message (ADT^A40), the department Report Repository matches the patient based on the identifiers in the message and merges demographics data and the reports that are linked to the identifier.

The updates are for the metadata associated with the reports in the report repository to enable searching of the reports based on demographics

6.5 Relationship to Content Profiles

615 Displayable Reports is a *workflow* profile – it is agnostic with respect to the clinical content of the data produced and handled. However, reports that are produced for specific specialties may have very specific requirements with regard to the clinical data used in those specialties. Thus, for instance, cardiology imaging procedure reports will have requirements with regard to cardiac-related data elements, such as cardiac function and morphology. Such specialty specific data interoperability requirements are described in IHE Technical Frameworks as *content*

620 profiles.

625 CDA documents, in particular, may be produced in accordance a variety of guidelines defined by IHE or medical professional societies. Thus products for a particular market may need to claim compliance to both workflow and content profiles – e.g., Displayable Reports *and* Cardiology Imaging Report Content. However, content profiles are not within the scope of this Profile.

Add the following new appendices

Appendix Y: Displayable Report Distribution Using the DRPT, RID and XDS Profiles

630

Different mechanisms may be used to access displayable report data from systems in the department in which it was generated, from other departments within the enterprise, and from outside the institution, even though the accessed content is the same to all these users.

635

IHE specifies three Profiles generally corresponding to the three environments: DRPT for departmental access, RID for intra-enterprise access, and XDS for cross-enterprise access (see table Y-1).

Table Y-1: Comparison of Displayable Report Distribution Profiles

Profile		DRPT	RID	XDS
Scope		Departmental	Enterprise	Cross-enterprise
Actors	Report Source	Report Manager	<not specified>	Document Source
	Server	Report Repository	Information Source	Document Repository
	Directory	Report Repository	Information Source	Document Registry
	Client	Report Reader	Display	Document Consumer
Transactions / protocols	Document submission	Encapsulated Report Storage [CARD-9] / DICOM Store	<not specified>	Provide and Register Document Set [ITI-15] / ebXML
	Query	Query Reports [CARD-10] / DICOM Query	Retrieve Specific Information for Display [ITI-11] / HTTP	Query Registry [ITI-16] / ebXML+SQL
	Retrieve	Retrieve Reports [CARD-11] / DICOM Retrieve	Retrieve Document for Display [ITI-12] / HTTP	Retrieve Document [ITI-17] / HTTP

640

While the three access mechanisms are associated with different actors, a product implementation may in fact group actors so that, for instance, a single repository may serve as the server for more than one mechanism. In fact, such grouping between the Report Repository actor of the DRPT Profile and the Information Source actor of the RID Profile is mandatory. This Appendix describes several typical grouping combinations; this is by no means an exhaustive list.

645

In these examples, grouping is facilitated by the use of a single report content format in all three Profiles.

Y.1 Three Repositories

650

In this example, separate repositories at the department, enterprise, and cross-enterprise levels each keep a copy of the report. See figure Y-1, where each repository is marked in gray; each repository may include several actors from different Profiles.

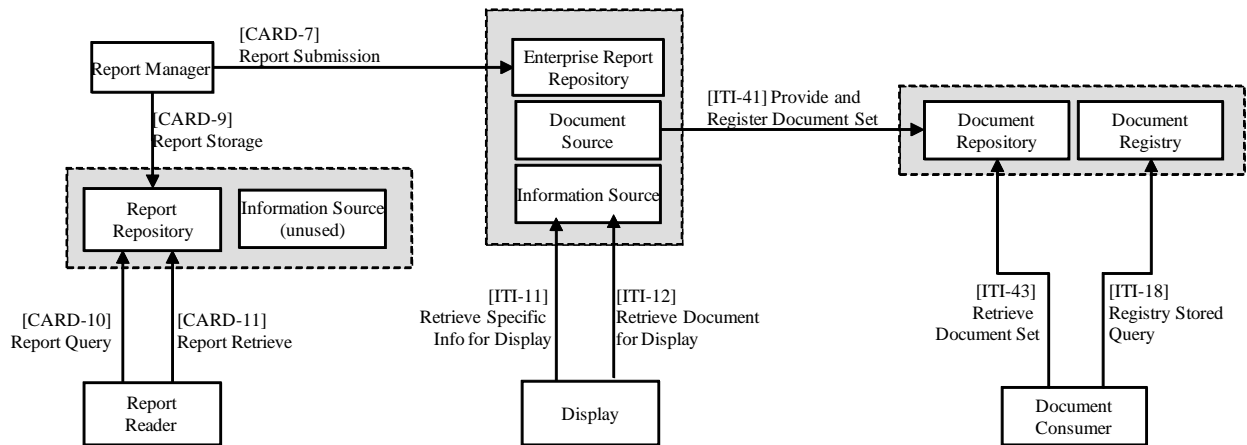

655

Figure Y-1: Three Repositories

The report is finalized in PDF or CDA format in the Report Manager. It is encapsulated in a DICOM object and sent to the Report Repository for departmental storage. It is encapsulated in an HL7 message and sent to the Enterprise Report Repository. The Enterprise Report Repository is grouped with the XDS Document Source, and when it is desired to share the report externally, it is re-wrapped in ebXML and forwarded to the XDS Document Repository.

660

Thus a departmental DICOM-based Report Reader workstation can query the Report Repository for the report and retrieve it using the DICOM protocol. Any enterprise Display workstation can query the Enterprise Report Repository for the report, as that repository is here also grouped with a RID Information Source actor, and retrieve the (unwrapped) PDF or CDA using the HTTP protocol. Similarly, any Document Consumer workstation in the cross-enterprise sharing domain can query the XDS Document Registry, and retrieve the report from the XDS Document Repository.

665

In this example, even though the Report Repository is grouped with a RID Information Source actor, the environment does not require that capability to be used.

670 **Y.2 Two Repositories – Distributed Enterprise Storage**

In this example, the departmental Report Repository stores the report for both department and enterprise access; a separate repository is used for cross-enterprise access. See figure Y-2, where each repository is marked in gray. This architecture is typical of an enterprise storage architecture where the central repository only maintains reference links to the data actually held in distributed departmental level storage systems.

675

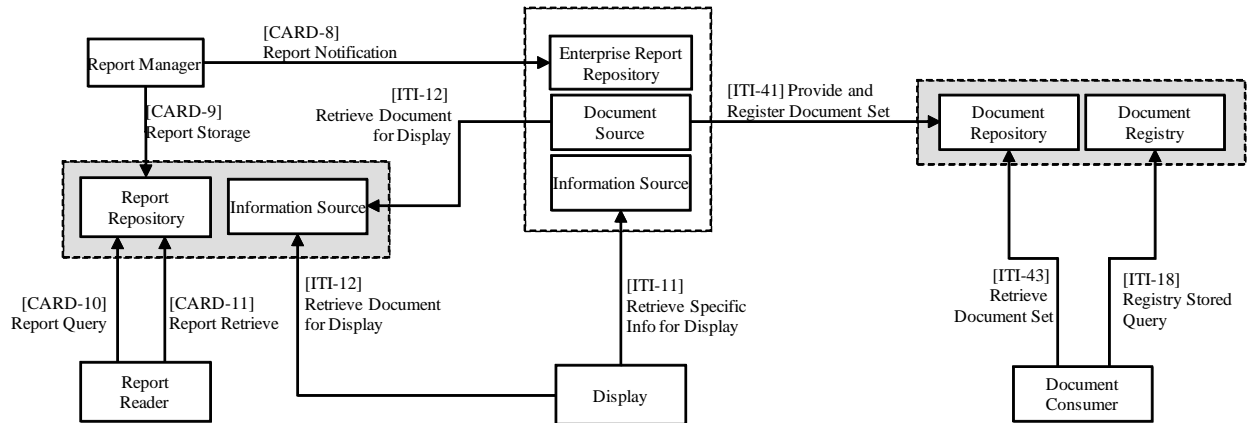

680 **Figure Y-2: Two Repositories – Distributed Enterprise Storage**

The report is finalized in PDF or CDA format in the Report Manager. It is encapsulated in a DICOM object and sent to the Report Repository for departmental/enterprise storage. The Report Repository is grouped with a RID Information Source actor, which will support HTTP GET of the document using the Retrieve Document for Display transaction.

685 The Report Manager sends the Enterprise Report Repository an HL7 message with a reference pointer to the report, using the RID URI to the report in the Report Repository.

As in the previous example, the Enterprise Report Repository is grouped with the XDS Document Source. To externally share the report, it must retrieve it from the Report Repository using the RID transaction, and then re-wrap the report in ebXML to be forwarded to the XDS Document Repository.

690 Query and retrieve of the report is the same as in the previous example, except for enterprise Display workstations. They may query the Enterprise Report Repository for the report, but receive a link to the departmental Report Repository for retrieving the (unwrapped) PDF or CDA, rather than retrieving it from the Enterprise Report Repository.

695 **Note:** The Enterprise Report Repository could also provide a document retrieval link to itself, but then use an HTTP Redirect to throw the retrieval to the departmental Report Repository.

Y.3 Two Repositories – Distributed Enterprise Storage, No DICOM Access

700 In this example, the Integrated Report Manager/Repository stores the report for both department and enterprise access; as in the previous example, a separate repository is used for cross-enterprise access. However, no DICOM access to the report is provided, and in this case intra-departmental report access uses the RID Profile. See figure Y-3.

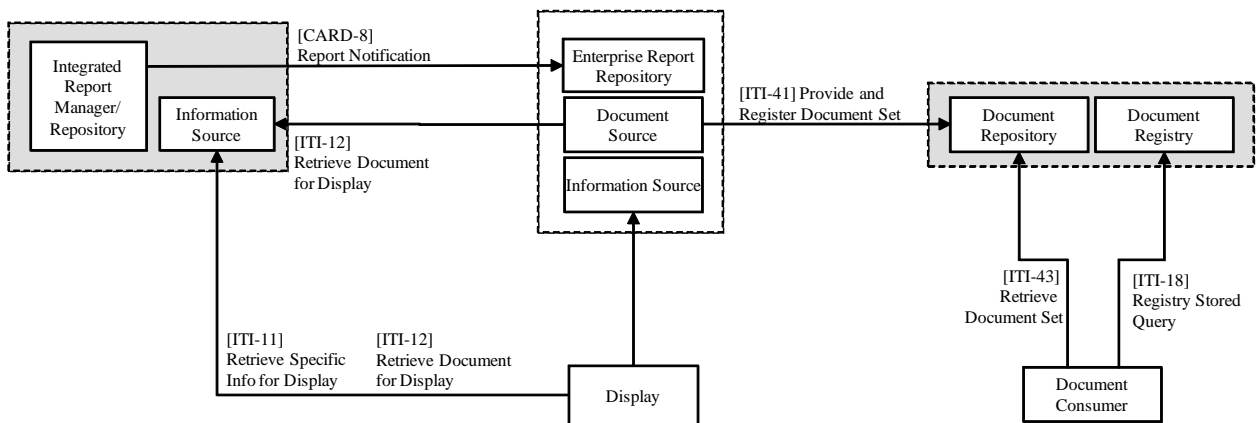

705

Figure Y-3: Two Repositories – Distributed Enterprise Storage

The report is finalized in PDF or CDA format in the Report Manager, which also stores the report in its grouped Report Repository. The Report Repository is also grouped with a RID Information Source actor, which will support HTTP GET of the document using the Retrieve Document for Display transaction. This system does not support the DICOM Storage Option, so all workstations that wish to access the reports must use the RID Profile.

710

Operation of the Enterprise Report Repository, Display, and XDS actors is identical to the previous example.

Note: The Display actor could also directly query the Information Source grouped with the Report Manager to access a list of departmental reports.

715

Y.4 Two Repositories – Distributed Cross-Enterprise Storage

In this example, a single repository stores the report for both intra-enterprise and cross-enterprise access; a separate repository is used for department access. See figure Y-4. This architecture is typical of a cross-enterprise storage architecture where the domain supports only a central registry, and data is managed by each of the participating institutions.

720

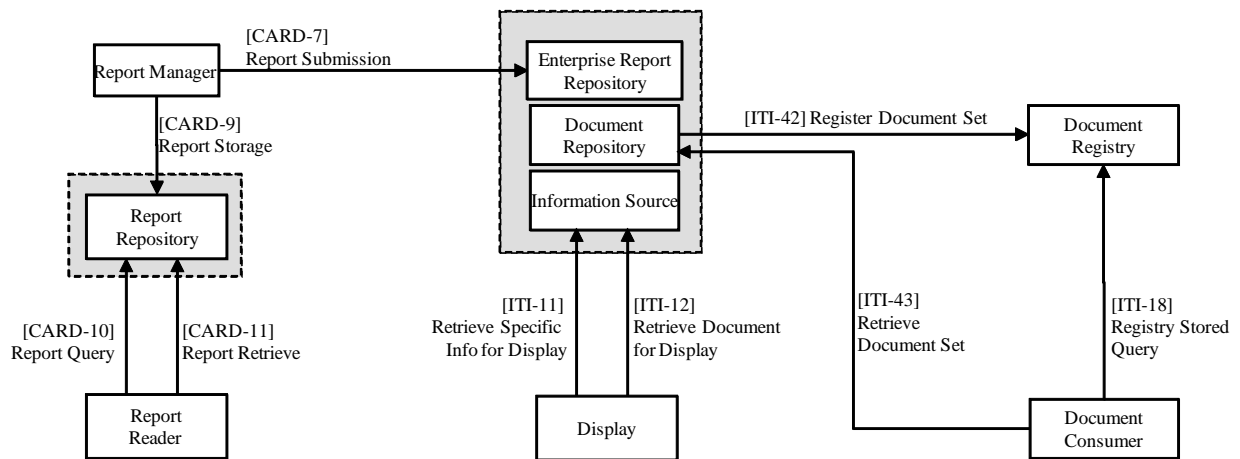

Figure Y-4: Two Repositories – Distributed Cross-Enterprise Storage

725 This example is similar to the three repositories example. The difference is that the Enterprise Report Repository is grouped with the XDS Document Repository, and only submits document registration to the XDS Document Registry.

Appendix Z: Displayable Report Signing

730 A displayable report that has been finalized by the reporting clinician may be signed in a number of ways. More than one of these methods may be used for a single document, but those multiple signatures must be consistent. The DRPT Profile does not specify a required signature mechanism, and there may be others beyond those described here.

The first method is to simply include a graphic or image of the clinician’s signature in the displayable page content. While this is useful for display, it is not electronically secure.

735 A second mechanism is to maintain a “signature on file”; i.e., the document asserts that it has been signed, but verification of the signature requires an audit process of the report creation and finalization application. The audit must be able to show that the asserted signature corresponds to a signing act by the identified clinician, and that the distributed document is identical to the original data presented during the signing process.

740 A third method is to attach a signature to the encapsulation of the document. For the DICOM encapsulation, a cryptographic digital signature mechanism is specified in the DICOM Standard (see PS3.3, section C.12.1.1.3). However, such a signature is lost when the document is extracted from the encapsulating message or object and distributed “naked”.

Notes: 1. HL7 v2.x does not define a digital signature mechanism.

745 2. Since a report may be persistently stored as a DICOM object in the Report Repository, a digital signature in that object can be treated as part of a “signature on file” mechanism.

750 The IHE Document Digital Signature (DSG) Profile specifies a digital signature by reference mechanism. A separate document provides a digital signature associates with a digital hash of the signed document. The DRPT Profile does not describe workflow for production of such external signatures from the Report Creator.

755 Finally, PDF includes its own internal cryptographic digital signature mechanism. Its use provides additional assurance that the content of the document has not been altered after application of the digital signature. While verification of the signature requires an audit process, that process can use the digital certificate registration authority, rather than the original report creating system.

760 An implementation may reasonably use several of these mechanisms, e.g., a displayable graphic for user convenience in hard-copy or soft-copy display plus a PDF digital signature, or a Legal Authenticator participation in a CDA plus a digital signature on the archival DICOM encapsulation of the report.

Volume 2 – Transactions

Add the following new transactions

4.7 Encapsulated Report Submission [CARD-7]

765 This section corresponds to Transaction CARD-7 of the IHE Cardiology Technical Framework. Transaction CARD-7 is used by the Report Creator, Report Manager and EHR-S actors.

4.7.1 Scope

In the Encapsulated Report Submission transaction, the Report Creator transmits PDF or CDA formatted reports as unsolicited HL7 Original Document Notification and Content message.

770 **4.7.2 Use Case Roles**

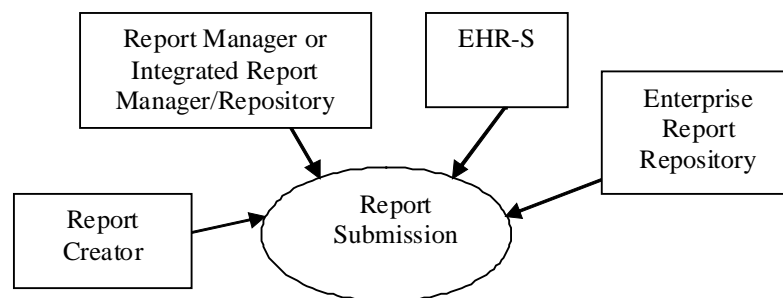

Actor: Report Creator

Role: Creates PDF or CDA report as a preliminary, final, or corrected final, and sends it to a Report Manager or EHR-S.

775 **Actor:** Report Manager or Integrated Report Manager/Repository

Role: Accepts report from Report Creator, releases report for distribution, and sends it to multiple repositories.

Actor: EHR-S

Role: Accepts report from Report Creator, and places it in its clinical data repository.

780 **Actor:** Enterprise Report Repository

Role: Accepts report from Report Manager or Integrated Report Manager/Repository, and makes it available for use across the enterprise.

4.7.3 Referenced Standards

HL7 Messaging Standard v.2.6, Chapter 9

785 ISO 19005-1. Document management – Electronic document file format for long-term preservation – Part 1: Use of PDF (PDF/A)

HL7 v3 Clinical Document Architecture Release 2

4.7.4 Interaction Diagram

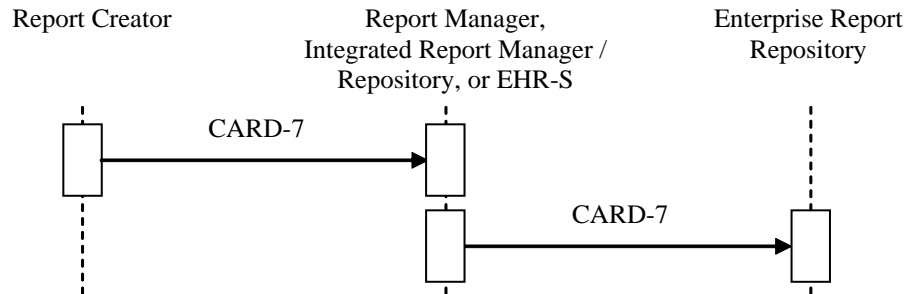

790

4.7.4.1 Encapsulated Report Submission

This section relates to the CARD-7 transaction between the Report Creator and the Report Manager, Integrated Report Manager/Repository, or EHR-S in the above interaction diagram in section 4.7.4.

4.7.4.1.1 Trigger Events

When a Report Creator has a new clinical report to be submitted, the Report Creator initiates the CARD-7 transaction with the Report Manager, Integrated Report Manager/Repository, or EHR-S using the Original Document Notification and Content message.

- 800 Notes:
1. The overall structure and content of a CDA document may be specified by a Content Profile or other implementation guide (e.g., see the IHE PCC XDS Medical Summaries Profile).
 2. The Report Creator may provide functionality to transcode portions of Evidence Documents or Key Image Notes (including image references) into the report, or to incorporate illustrative images, based on the study data.

4.7.4.1.2 Message Semantics

805 The CARD-7 transaction shall be an HL7 V2 MDM^T02 message from the Report Creator to the Report Manager, Integrated Report Manager/Repository, or EHR-S with a corresponding ACK message back to the Report Creator. Refer to the HL7 2.6 Standard, Chapter 9 for general message semantics.

810

Table 4.7-1: IHE Profile – Encapsulated Report Submission MDM Message

MDM^T02	Document Notification and Content	Chapter in HL7 2.6	Comment
MSH	Message Header	2	
EVN	Event Type	3	
PID	Patient Identification	3	
PV1	Patient Visit	3	
ORC	Order Common	4	
OBR	Order detail	4	
TXA	Document Notification	9	
{OBX}	Observation/Result	7, 9	

The PV1 Segment is required if use of PV1-19 Visit Number is required per the applicable regional or national appendices to the IHE Technical Framework (See RAD TF-4).

815 The following subsections provide field-by-field definitions of the required segments of the MDM message of the CARD-7 transaction. The tables shall be interpreted according to the HL7 Standard v2.6, unless otherwise specified in notes beneath the tables.

4.7.4.1.2.1 MSH Segment

Table 4.7-2: IHE Profile – MSH segment

SEQ	LEN	DT	OPT	Rep/#	TBL#	ITEM #	ELEMENT NAME
1	1	ST	R			00001	Field Separator
2	4	ST	R			00002	Encoding Characters
3	180	HD	R			00003	Sending Application
4	180	HD	R			00004	Sending Facility
5	180	HD	R			00005	Receiving Application
6	180	HD	R			00006	Receiving Facility
9	7	CM	R			00009	Message Type
10	20	ST	R			00010	Message Control ID
11	3	PT	R			00011	Processing ID
12	60	VID	R		0104	00012	Version ID
18	6	ID	C		0211	00692	Character Set
21	427	EI	R2	Y		01598	Message Profile Identifier

Adapted from the HL7 Standard, version 2.6

820 The IHE Technical Framework requires that applications support HL7-recommended values for the fields MSH-1 Field Separator and MSH-2 Encoding Characters.

Field MSH-9 Message Type shall have three components: “MDM^T02^MDM_T02”.

825 Field MSH-21 Message Profile Identifier shall contain one field repetition with the value “CARD-7^IHE”. The purpose is to provide guidance to the receiver on expected actions associated with this message.

Implementations supporting sequence number protocol shall be configurable to allow them to perform this transaction without such protocol.

4.7.4.1.2.2 EVN Segment

Table 4.7-3 identifies required fields in the EVN segment.

830

Table 4.7-3: IHE Profile - EVN segment

SEQ	LEN	DT	OPT	Rep/#	TBL#	ITEM#	ELEMENT NAME
2	26	DTM	R			00100	Recorded Date/Time

Adapted from the HL7 Standard, version 2.6

4.7.4.1.2.3 PID and PV1 Segments

835

Table 4.7-4: IHE Profile - PID segment

SEQ	LEN	DT	OPT	Rep/#	TBL#	ITEM#	ELEMENT NAME
3	250	CX	R			00106	Patient Identifier List
5	250	XPN	R			00108	Patient Name
7	26	DTM	RE			00110	Date/Time of Birth
8	1	IS	RE		0001	00111	Sex
10	80	CE	RE		0005	00113	Race
11	250	XAD	RE			00114	Patient Address
18	250	CX	RE			00121	Patient Account Number

Adapted from the HL7 standard, version 2.6

Table 4.7-5: IHE Profile – PV1 segment

SEQ	LEN	DT	OPT	Rep/#	TBL#	ITEM#	ELEMENT NAME
2	1	IS	R		0004	00132	Patient Class
19	20	CX	RE			00149	Visit Number
51	1	IS	C		0326	01226	Visit Indicator

Adapted from the HL7 standard, version 2.6

840

Note: The fields *PID-18 Patient Account Number* and *PV1-19 Visit Number* have requirements for the values in the use of the PID segment in ADT and Order Messages (see, e.g., transactions RAD-3 and RAD-4). In the context of this MDM message, these values may not be known, but if known, shall be included in the message.

Field *PV1-51 Visit Indicator* shall be valued with value “V” if the field *PV1-19 Visit Number* is present. It may be omitted otherwise.

845 **4.7.4.1.2.4 ORC Segment**

Table 4.7-6: IHE Profile - ORC Segment

SEQ	LEN	DT	OPT	Rep/#	TBL #	ITEM #	ELEMENT NAME
1	2	ID	R		0119	00215	Order Control
2	122	EI	R			00216	Placer Order Number
3	122	EI	R			00217	Filler Order Number
4	2	DT	R		0038	00219	Order Status

Adapted from the HL7 Standard, version 2.6

ORC-1 shall have the value “SC” (status change); ORC-5 shall have the value “CM”.

850 The ORC-2 Placer Order Number and ORC-3 Filler Order Number fields are required to be filled by the Report Creator.

Note: The method by which the Report Creator obtains the Placer Order Number (ORC-2, OBR-2, TXA-14), Filler Order Number (ORC-3, OBR-3, TXA-15) and Study Instance UID (OBX-5) is beyond the scope of this transaction. The Report Creator may receive this information from a Procedure Scheduled [RAD-4] transaction. It may also obtain this information from images or other study evidence that are referenced during the reporting process.

855

If the Report Creator does not have these identifiers from the actual Placer and Filler systems, it shall fill the fields with an identifier that it creates, and identify the assigning authority as itself.

4.7.5.1.2.5 OBR Segment

Table 4.7-7: IHE Profile - OBR Segment

SEQ	LEN	DT	OPT	Rep/#	TBL#	ITEM#	ELEMENT NAME
1	4	SI	R			00237	Set ID OBR
2	122	EI	RE			00216	Placer Order Number
3	122	EI	RE			00217	Filler Order Number
4	200	CE	R			00238	Universal Service ID
7	26	DTM	R			00241	Observation Date/Time
25	1	ID	R		See table 4.7-8	00258	Result Status

860

Adapted from the HL7 Standard, version 2.6

Field OBR-7 is the clinically relevant date/time of the observation; i.e. it is the date/time of the procedure, not the date/time of the report.

The Result Status values of table 4.7-8 shall be supported in field OBR-25.

865

Table 4.7-8: Supported Result Status Values

Value	Description
R	Results stored; not yet verified
P	Preliminary: A verified early result is available,

Value	Description
	final results not yet obtained
F	Final results; results stored and verified. Can only be changed with a corrected result.
C	Correction to results

Adapted from the HL7 Standard, version 2.6, Table 0123

870

Note: Unverified reports, commonly referred to as “preliminary”, are reported with status value “R” rather than “P”. Only results that have had clinician overreading and signature may be reported with status value “P”. “P” is used more in the case of laboratory results, where a final result may be awaiting development of a culture, but the preliminary results are usable for clinical treatment planning.

4.7.4.1.2.6 TXA Segment

Table 4.7-9: IHE Profile – TXA Segment for Encapsulated Report

SEQ	LEN	DT	OPT	Rep/#	TBL#	ITE M#	ELEMENT NAME
1	4	SI	R			00914	Set ID- TXA
2	30	IS	R		See table 4.7-9a	00915	Document Type
3	2	ID	R			00916	Document Content Presentation
7	26	DT M	R			00920	Transcription Date/Time
11	250	XC N	C	Y		00924	Transcriptionist Code/Name
12	70	EI	R			00925	Unique Document Number
13	70	EI	C			00926	Parent Document Number
14	122	EI	RE	Y		00216	Placer Order Number
15	122	EI	RE			00217	Filler Order Number
17	2	ID	R		See table 4.7-10	00928	Document Completion Status
21	30	ST	C			00933	Document Change Reason
22	250	PP N	RE	Y		00934	Authentication Person, Time Stamp

Adapted from the HL7 Standard, version 2.6

875

TXA-2 Document Type: Table 4.7-9a specifies the values that shall be used for listed report types. (Other Document Type code values can be used for report types that are not represented in the table.) The table 4.7-9a values can be mapped to the categories of summary requests specified in the Retrieve Specific Info for Display [ITI-11] and Retrieve ECG List [CARD-5] transactions.

880

Table 4.7-9a: IHE Profile – Document type

Value	Description	Comment	Mapping to ITI-11 requestType value
CD	Cardiology	from table 0270	SUMMARY-CARDIOLOGY
DI	Diagnostic imaging	from table 0270	SUMMARY-RADIOLOGY
DS	Discharge summary	from table 0270	SUMMARY-DISCHARGE
ED	Emergency department report	from table 0270	SUMMARY-EMERGENCY
ECG	Electrocardiogram report	IHE addition	SUMMARY-CARDIOLOGY-ECG (requestType value from CARD-5 transaction)
ICU	Intensive care report	IHE addition	SUMMARY-ICU
LAB	Laboratory report	IHE addition	SUMMARY-LABORATORY
OP	Operative report	from table 0270	SUMMARY-SURGERY

Adapted from the HL7 Standard, version 2.6 Table 0270

885 TXA-3 shall have the same value as OBX-5.2 of the OBX segment with the encapsulated report.
TXA-7 shall contain the date and time that the report was originally created.

Note: This field is required because TXA-17 in this transaction is never valued “DI” (dictated).

TXA-11 shall have a value if the report is manually transcribed from dictation. It does not apply for reports transcribed by automated voice recognition.

890 TXA-12 shall contain a unique document identifier. If multiple reports are created for the order, each report shall be sent in a separate MDM message and shall contain a unique identifier in TXA-12. Each intermediate report version shall have its own unique object identifier, so that it can be individually accessed. The unique identifier shall be an OID in accordance with ITI TF 2: Appendix B.

895 Note: This requires the OID to be limited to 64 characters

TXA-17 Document Completion Status: This field contains the reference to the current completion state of the document, in accordance with table 4.7-10.

900 TXA-22: This field shall be present if TXA-17 value is “AU” or “LA”. At least one of TXA-22.2 or TXA-22.3 (Family name and Given Name) shall be valued and TXA-22.15 (Date /Time Action Performed) shall be valued.

Table 4.7-10: IHE Profile – Document completion status

Value	Description	Comment	Mapping to OBR-25 Result Statuses
PA	Pre-authenticated		R
AU	Authenticated		P, F, C
LA	Legally authenticated		F, C

Adapted from the HL7 Standard, version 2.6 Table 0271

4.7.4.1.2.7 OBX for Study Instance UID

905 An OBX Segment is defined to convey the DICOM Study Instance UID for which the report is submitted, if applicable (see table 4.7-11). This Segment shall be included in the MDM if the report is created for a Requested Procedure managed by the Department System Scheduler/Order Filler.

910 **Table 4.7-11: IHE Profile – OBX Segment with DICOM Study Instance UID**

SEQ	LEN	DT	OPT	Rep/#	TBL#	ITEM#	ELEMENT NAME
1	4	SI	R			00569	Set ID – OBX
2	3	ID	R		0125	00570	Value Type = HD
3	80	CE	R			00571	Observation Identifier
5	70	HD	R			00573	Observation Value
11	1	ID	R		0085	00579	Observation Result Status = O

Adapted from the HL7 Standard, version 2.6

The OBX-3 Observation Identifier field shall have the value “113014^DICOM Study^DCM”.

The OBX-5 Observation Value shall include the Study Instance UID as an ISO OID.

The OBX-11 Observation Result Status shall have the value “O” (Order detail description).

915 Note: The method by which the Report Creator obtains the Study Instance UID (OBX-5) is beyond the scope of this transaction. The Report Creator may receive this information from a Procedure Scheduled [RAD-4] transaction. It may also obtain this information from images that are referenced during the reporting process.

4.7.4.1.2.8 OBX for Encapsulated Report

An OBX Segment is defined to convey the encapsulated report (see table 4.7-12).

920

Table 4.7-12: IHE Profile – OBX Segment with Encapsulated Report

SEQ	LEN	DT	OPT	Rep/#	TBL#	ITEM#	ELEMENT NAME
1	4	SI	R			00569	Set ID – OBX
2	3	ID	R		0125	00570	Value Type = ED
3	80	CE	R			00571	Observation Identifier
5	*	ED	R			00573	Observation Value
11	1	ID	R		See table 4.7-13	00579	Observation Result Status

Adapted from the HL7 Standard, version 2.6

925 Field OBX-3 Observation Identifier shall be used for the report title. In accordance with HL7 CE Data Type requirements, a local (private) title may be encoded only with OBX-3.2 valued (e.g., “^Interventional Radiology Report”).

Note: This field may use document names from the HIPAA Attachments class of the LOINC coding scheme. See Appendix D for examples of report titles. If LOINC does not have appropriate titles, the Report Creator can assign titles from some other resource (including private titles).

930 Field OBX-5 Observation Value contains the report document in PDF/A or CDA Release 2 format. The values of the OBX-5 components shall be in accordance with table 4.7-12a.

Table 4.7-12a: OBX-5 Component Values

Component ID	Value for PDF/A Content	Value for CDAR2 Content
OBX-5.1 Source Application	<i>not used</i>	<i>not used</i>
OBX-5.2 Type of Data	Application	Text
OBX-5.3 Data Subtype	PDF	XML
OBX-5.4 Encoding	Base64	A
OBX-5.5 Data	<i>PDF document in accordance with ISO 19005-1, encoded in base64</i>	<i>CDA document with HL7v2 delimiters escaped</i>

- 935 Notes: 1. An actor participating in this transaction must support encapsulated data with a length beyond the nominal 65536 byte limit of the OBX-5.
2. Considering that a PDF document may become disassociated from its HL7 or DICOM encapsulation, it is recommended that a PDF document contain in its displayable content the patient identification, and the dates of the procedure and of the report. (This data is part of the CDA Header, and included in every CDA document.)
- 940 3. The OBX-5.5 Data encoded stream must not include CR/LF characters, which are forbidden within HL7 field text streams.
- Breaking a base64 encoded stream into lines of 76 characters or less is used for email in accordance with RFC 822, but is not applicable to encapsulated data in HL7. PDF binary files should be encoded into a continuous stream of base64 characters without line breaks.
- 945 CDA XML must have its characters that are also used as HL7 v2 delimiters escaped in accordance with HL7 v2.6 section 2.7 (e.g., ^ becomes \^). CR/LF characters are then escaped to the repetition delimiter (~) in accordance with the specification for the TX data type.
- 950 4. The overall structure and content of a CDA document may be specified by a Content Profile or other implementation guide (e.g., see the Cardiac Imaging Report Template Profile). CDA Level 3 (structured entry) content may be based on measurements or observations from DICOM Structured Report objects (Evidence Documents). The relationship between specific SR Template Content Items and the CDA entries may be specified in the Content Profile.
- The mechanism the Report Creator uses to transcode from DICOM SR to CDA is outside the scope of this Profile.
- 955 5. A stylesheet for rendering CDA documents may be referenced by URL in the CDA (see PCC-TF-2: 6.3.1.1.4). This URL may reference a server that is widely accessible within the local deployment environment (i.e., accessible by local area network to all local receivers of the CDA document). The stylesheet does not need to be distributed with the CDA document within the local deployment environment, but may need to be sent if the CDA is forwarded outside the institution (by wide area network or by exchange media) using mechanisms outside the scope of this transaction.
- 960 The Observation Result Status values of table 4.7-13 shall be supported in field OBX-11. The value shall be consistent with the value in field OBR-25.

Table 4.7-13: Supported Observation Result Status Values

Value	Description	Corresponding OBR-25 Value
R	Results entered – not verified	R
P	Preliminary results	P
F	Final results; Can only be changed with a corrected final result.	F
C	Record coming over is a correction and thus replaces a final result	C

Adapted from the HL7 Standard, version 2.6, Table 0085

965 4.7.4.1.2.9 Additional OBX Segments

Additional OBX segments, beyond the ones conveying the Study Instance UID and the encapsulated report, may be present in the MDM. These may be used to convey significant measurements present in the displayable report in a manner conducive to automated processing. Such use may be specified for specific profiles in this section, or in a Content Profile that has a binding to this transaction.

Note: The Report Creator may create these OBX segments based on measurements or observations from DICOM Structured Report objects (Evidence Documents). The relationship between specific SR Template Content Items and the OBX Segments may be specified in the Content Profile.

975 The mechanism the Report Creator uses to transcode from DICOM SR to OBX is outside the scope of this Profile.

4.7.4.1.2.9.1 ECG Content Profile

Reserved for ECG Content Profile specification of data elements to be conveyed in OBX segments.

980 4.7.4.1.3 Expected Actions

Upon receipt of this message, the Report Manager, Integrated Report Manager/Repository, or EHR-S may apply application-specific report processing rules (e.g., presentation to a user for verification or signature). The Report Manager, Integrated Report Manager/Repository, or EHR-S shall determine when the report is to be released, or made available, to the enterprise.

985 For PDF documents, the Report Manager, Integrated Report Manager/Repository, or EHR-S shall have the capability to edit the PDF content, at a minimum by adding a “cover page” with the report status, and identity of signing clinician. This may also involve further modification of the PDF content (e.g., to add a digital signature).

990 For CDA documents, the Report Manager, Integrated Report Manager/Repository, or EHR-S shall have the capability to edit the CDA content, at a minimum by adding a Legal Authenticator participation.

995 The Report Manager, Integrated Report Manager/Repository, or EHR-S shall also have the capability to modify the status of the report. If a prior transaction to the Enterprise Report Repository had already occurred, the transaction following the status change shall be an HL7 V2 MDM T^10 Document Replacement notification from the Report Manager or Integrated Report Manager/Repository to the Enterprise Report Repository.

1000 The Report Manager, Integrated Report Manager/Repository, or EHR-S shall support multiple reports with different titles (Encapsulated Report segment OBX-3 Observation Identifier) submitted for the same Requested Procedure or Order. Each document title shall be treated independently for the purpose of the report processing rules.

1005 Notes: 1. The Report Manager, Integrated Report Manager/Repository, or EHR-S must support multiple reports with same or different titles submitted for the same Order, and if the Order is mapped to multiple Requested Procedures, and then it must support multiple reports with different titles submitted for each Requested Procedure identified in the OBX with the Study Instance UID. To uniquely identify each document, each document shall contain a unique document identifier (OID) in TXA -12 of the message.

2. For example, a Requested Procedure for a Cardiac Catheterization may result in the Report Creator submitting one report titled “Cardiac Cath Diagnostic Report” and a second report titled “Cardiac Cath Intervention Report”. Verification, signature, and distribution of these two reports are handled separately, and may indeed be associated with two different physicians.

1010 When the Report Manager, Integrated Report Manager/Repository, or EHR-S has determined that the report is to be made available to the enterprise, it shall guarantee long term storage of the report in the department; for a Report Manager not part of an Integrated Report Manager/Repository, this is done by forwarding the report to the Report Repository (see Transaction CARD-9).

1015 Note: The Report Manager application-specific processing rules may dictate that some or all unverified or preliminary reports are made available to the enterprise, or that only finalized and corrected final reports are made available.

The Integrated Report Manager/Repository or EHR-S shall make reports available through the grouped Information Source actor of the ITI Retrieve Information for Display Profile.

1020 Note: The Integrated Report Manager/Repository in the DRPT Profile and the EHR-S in the IEO Profile are grouped with the RID Profile Information Source actor. The list of available reports is made available using transaction ITI-11 Retrieve Specific Info for Display, and the PDF or CDA content is made available for retrieve using transaction ITI-12 Retrieve Document for Display.

1025 The ITI-11 requestType values supported by the Information Source are not specified by this transaction. The Integrated Report Manager/Repository or EHR-S may classify reports in accordance with the TXA-2 value as shown in table 4.7-9a, or by their titles to respond to different requestTypes. For classification by title, e.g., CT Head Report (LOINC code 11539-4) and MRI Report (LOINC 18755-9) would be included in a response to the SUMMARY-RADIOLOGY requestType, while Cardiac Catheterization Report (LOINC 18745-0) and Echocardiography Report (LOINC 11522-0) would be included in a response to the SUMMARY-CARDIOLOGY requestType.

1030 **4.7.4.2 Encapsulated Report Update**

This transaction relates to the CARD-7 transaction between the Report Creator and the Report Manager, Integrated Report Manager/Repository, or EHR-S in the above interaction diagram.

4.7.4.2.1 Trigger Events

1035 When a Report Creator has a revision of a prior report to be submitted, the Report Creator initiates the CARD-7 transaction with the Report Manager, Integrated Report Manager/Repository, or EHR-S using the Document Replacement Notification and Content message.

4.7.4.2.2 Message Semantics

1040 The CARD-7 transaction shall be an HL7 V2 MDM^T10 message from the Report Creator to the Report Manager with a corresponding ACK message back to the Report Creator. Refer to the HL7 2.6 Standard, Chapter 9 for general message semantics.

Table 4.7-14: IHE Profile – Encapsulated Report Submission MDM Message

MDM^T10	Document Replacement Notification and Content	Chapter in HL7 2.6	Comment
MSH	Message Header	2	
EVN	Event Type	3	
PID	Patient Identification	3	
PV1	Patient Visit	3	
ORC	Order Common	4	
OBR	Order detail	4	
TXA	Document Notification	9	
{OBX}	Observation/Result	7, 9	

1045 Except as provided below, the content of this message is identical to that of the MDM^T02 message specified in 4.7.4.1.1.

4.7.4.2.2.1 MSH Segment

MSH-9 shall have the value “MDM^T10^MDM_T02”.

4.7.4.2.2.2 TXA Segment

Table 4.7-15: IHE Profile – TXA Segment with Reference to a Report

SEQ	LEN	DT	OPT	Rep/#	TBL#	ITEM#	ELEMENT NAME
1	4	SI	R			00914	Set ID- TXA
2	30	IS	R		See table 4.7-9a	00915	Document Type
3	2	ID	R			00916	Document Content Presentation
7	26	DT M	C			00920	Transcription Date/Time
11	250	XC N	C	Y		00924	Transcriptionist Code/Name

SEQ	LEN	DT	OPT	Rep/#	TBL#	ITEM#	ELEMENT NAME
12	70	EI	R			00925	Unique Document Number
13	70	EI	RE			00926	Parent Document Number
14	122	EI	RE	Y		00216	Placer Order Number
15	122	EI	RE			00217	Filler Order Number
17	2	ID	RE		See table 4.7-10	00928	Document Completion Status
21	30	ST	C			00933	Document Change Reason
22	250	PPN	RE	Y		00934	Authentication Person, Time Stamp

1050

Adapted from the HL7 Standard, version 2.6

TXA-13 Parent Document shall contain the Unique Document Number of the document being replaced. This shall be the value of TXA-12 Unique Document Number in the MDM message for the parent document.

4.7.4.2.3 Expected Actions

1055

Upon receipt of this message, the Report Manager, Integrated Report Manager/Repository, or EHR-S may apply application-specific report processing rules, as described in 4.7.4.1.3.

The Report Manager, Integrated Report Manager/Repository, or EHR-S shall replace the existing document, identified in TXA-13 of the MDM^T10, with the new document, in accordance with its rules for accepting replacement notifications from external sources.

1060

4.7.4.3 Encapsulated Report Submission to Enterprise

This transaction relates to the CARD-7 transaction between the Report Manager or Integrated Report Manager/Repository and the Enterprise Report Repository.

4.7.4.3.1 Trigger Events

1065

When the Report Manager or Integrated Report Manager/Repository deems a clinical report ready for communication to the enterprise, e.g., by completion of a signature process, and the Enterprise Report Repository supports the Encapsulated Reports option, the Report Manager or Integrated Report Manager/Repository initiates the CARD-7 transaction with the Enterprise Report Repository using the Original Document Notification and Content message.

1070

Note: The Report Manager or Integrated Report Manager/Repository will be configured to initiate either a CARD-7 or a CARD-8 transaction with the Enterprise Report Repository whenever a clinical report is deemed ready for communication to the enterprise. The appropriate transaction is determined by the option supported by the Enterprise Report Repository.

4.7.4.3.2 Message Semantics

1075

The CARD-7 transaction shall be an unsolicited HL7 V2 MDM^T02 message from the Report Manager or Integrated Report Manager/Repository to the Enterprise Report Repository with a

corresponding ACK message back to the Report Manager or Integrated Report Manager/Repository. Except as provided below, the content of this message is identical to that of the MDM^T02 message described in 4.7.4.1.2.

4.7.4.3.2.1 ORC, OBR, and TXA Segments

1080 If the ORC-2/OBR-2/TXA-14 Placer Order Number and ORC-3/OBR-3/TXA-15 Filler Order Number fields were filled by the Report Creator with identifiers assigned by the Report Creator, the Report Manager or Integrated Report Manager/Repository shall replace them with the identifiers assigned by the Order Placer and Order Filler systems, respectively.

1085 Note: In the DRPT Profile, the Report Manager obtains the Placer Order Number and Filler Order Number through the RAD-4 Procedure Scheduled transaction.

4.7.4.3.2.2 OBX for Study Instance UID

The OBX that conveys the Study Instance UID (see 4.7.4.1.2.6) is optional for the MDM^T02 message from the Report Manager or Integrated Report Manager/Repository to the Enterprise Report Repository.

1090 4.7.4.3.3 Expected Actions

The Enterprise Report Repository shall make the report available to other systems in the Enterprise, in a manner outside the scope of this transaction.

4.7.4.4 Encapsulated Report Update Submission to Enterprise

4.7.4.4.1 Trigger Events

1095 When the Report Manager or Integrated Report Manager/Repository has a revision of a prior report ready for communication to the enterprise, and the Enterprise Report Repository supports the Encapsulated Reports option, the Report Manager or Integrated Report Manager/Repository initiates the CARD-7 transaction with the Enterprise Report Repository using the Document Replacement Notification and Content message.

1100 4.7.4.4.2 Message Semantics

The CARD-7 transaction shall be an HL7 V2 MDM^T10 message from the Report Manager or Integrated Report Manager/Repository to the Enterprise Report Repository with a corresponding ACK message back to the Report Manager or Integrated Report Manager/Repository. The content of this message is identical to that of the MDM^T10 message described in 4.7.4.1.2. The requirement for Placer Order Number and Filler Order Number described in 4.7.4.3.2.1 applies here as well. The OBX that conveys the Study Instance UID (see 4.7.4.1.2.6) is optional for the MDM^T10 message from the Report Manager or Integrated Report Manager/Repository to the Enterprise Report Repository

4.7.4.4.3 Expected Actions

1110 The Enterprise Report Repository shall replace the existing document, identified in TXA-13 of the MDM^T10, with the new document, and make the report available to other systems in the Enterprise, in a manner outside the scope of this transaction.

4.8 Report Reference Submission [CARD-8]

1115 This section corresponds to Transaction CARD-8 of the IHE Cardiology Technical Framework. Transaction CARD-8 is used by the Report Manager, Integrated Report Manager/Repository, Enterprise Report Repository and the Department System Scheduler/Order Filler actors.

4.8.1 Scope

In the Report Reference Submission transaction, the Report Manager or Integrated Report Manager/Repository transmits URL references to reports as Document Notifications.

1120 4.8.2 Use Case Roles

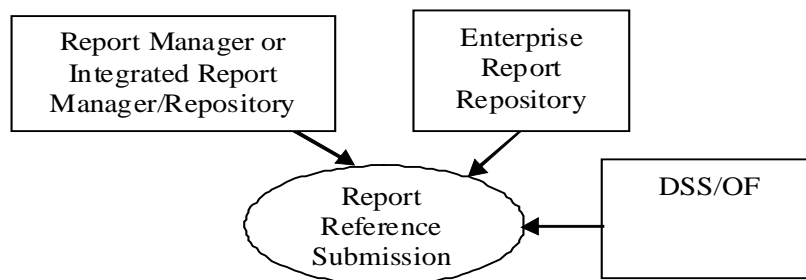

Actor: Report Manager or Integrated Report Manager/Repository

Role: Sends URL reference to report to an Enterprise Report Repository and the Department System Scheduler/Order Filler.

1125 **Actors:** Enterprise Report Repository and Department System Scheduler/Order Filler

Role: Accepts and stores the URL reference to report transmitted by the Report Manager or Integrated Report Manager/Repository.

4.8.3 Referenced Standards

HL7 Messaging Standard v.2.6

1130 4.8.4 Interaction Diagram

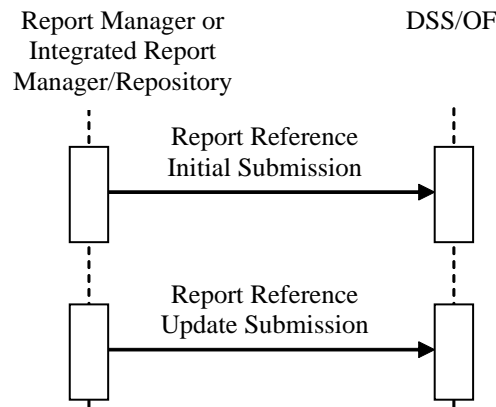
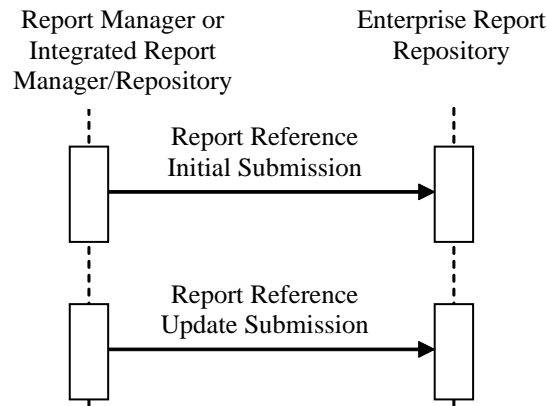

1135

4.8.4.1 Report Reference Initial Submission

This section relates to the Report Reference Initial Submission transaction between the Report Manager or Integrated Report Manager/Repository, Department System Scheduler/Order Filler and the Enterprise Report Repository in the above interaction diagram.

1140 4.8.4.1.1 Trigger Event

The Report Manager or Integrated Report Manager/Repository has determined that a new report is to be made available to the enterprise, and it has guaranteed long term storage of the report in the department by forwarding the report to the Report Repository. For a transaction to the Enterprise Report Repository, the Enterprise Report Repository must support the By-Reference Reports option.

1145

Note: The Report Manager or Integrated Report Manager/Repository will be configured to initiate either a CARD-7 or a CARD-8 transaction with the Enterprise Report Repository whenever a clinical report is deemed ready for communication to the enterprise. The appropriate transaction is determined by the option supported by the Enterprise Report Repository.

1150 **4.8.4.1.2 Message Semantics**

The transaction shall be an HL7 V2 MDM^T01 message. Refer to the HL7 2.6 Standard for general message semantics.

Table 4.8-1 IHE Profile – Encapsulated Report Submission MDM Message

MDM^T01	Original Document Notification	Chapter in HL7 2.6	Comment
MSH	Message Header	2	
EVN	Event Type	3	
PID	Patient Identification	3	
PV1	Patient Visit	3	
ORC	Order Common	4	
OBR	Order detail	4	
TXA	Document Notification	9	

1155 Except as provided below, the content of this message is identical to that of the MDM^T02 message described in 4.7.4.1.

4.8.4.1.2.1 TXA Segment

Table 4.8-2 IHE Profile - TXA Segment with Reference to a Report

SEQ	LEN	DT	OPT	Rep /#	TBL#	ITEM#	ELEMENT NAME
1	4	SI	R			00914	Set ID- TXA
2	30	IS	R		See table 4.7-9a	00915	Document Type
3	2	ID	R			00916	Document Content Presentation
7	26	DTM	R			00920	Transcription Date/Time
11	250	XCN	C	Y		00924	Transcriptionist Code/Name
12	70	EI	R			00925	Unique Document Number
13	70	EI	C			00926	Parent Document Number
14	122	EI	RE	Y		00216	Placer Order Number
15	122	EI	RE			00217	Filler Order Number
16	999	ST	RE			00927	Unique Document File Name
17	2	ID	RE		See table 4.7-10	00928	Document Completion Status
21	30	ST	C			00933	Document Change Reason
22	250	PPN	RE	Y		00934	Authentication Person, Time Stamp

Adapted from the HL7 Standard, version 2.6

1160 Field TXA-16 Unique Document File Name contains the reference to the report document. The field shall include the URL to access the stored report document in the format as specified in the Retrieve Document for Display (ITI-12) transaction (see ITI-TF 2: 3.12.4.1.2).

Note: The target address of the service of the URL is the RID Profile Information Source actor grouped with the Report Repository. The Report Manager or Integrated Report Manager/Repository needs to be configurable with the network address of the Information Source actor, in particular if the Information Source is in a separate system.

1165

4.8.4.1.2.2 OBX Segment

There are no OBX segments in an MDM^T01 message.

4.8.4.1.3 Expected Actions

1170 The Enterprise Report Repository receives the MDM with the URL reference to the report, and shall make the report available to other systems in the enterprise, in a manner outside the scope of this transaction.

Note: The Enterprise Report Repository may retrieve the report based on the URI, or use the reference as an index for a distributed “virtual” repository.

1175 The Enterprise Report Repository shall be prepared to receive, and make available to other systems in the enterprise, multiple reports with different OIDs (TXA12-5 Document Unique Identifier Value) for the same order number (see 4.7.4.1.3).

1180 The method by which the reports are made available to other systems by the Enterprise Report Repository is outside the scope of this profile. The Enterprise Report Repository may make the stored reports available by supporting the Retrieve Specific Info for Display [ITI-11] and Retrieve Document for Display [ITI-12] transactions of the Retrieve Information for Display Profile (see CARD TF-1: Appendix Y for sample implementations of this architecture).

1185 The Department System Scheduler/Order Filler actor shall receive a HL7 v2.6 MDM^T01 (Original Document Notification) in the CARD-8 transaction. The Department System Scheduler/Order Filler can use the information in the CARD-8 message to determine when to send an Order Complete message (ORM with status CM) to the Order Placer.

1190 Note: The Report Manager or Integrated Report Manager/Repository will not assert that the order is complete, and will not state that a Requested Procedure is complete; that is a responsibility of the Department System Scheduler/Order Filler. In the case of an order that has multiple Requested Procedures, or which requires multiple reports for order completion (e.g., a stress test with ECG and imaging components separately read), the Department System Scheduler/Order Filler *may* be able to implement an automated process, but may require manual review of the reports to verify completion of all order requirements.

The order complete message is described in RAD TF-2: 3.3, Filler Order Management

The Department System Scheduler/Order Filler must participate in a scheduled workflow or equivalent such as STRESS, CATH or ECHO profiles

1195 The Department System Scheduler/Order Filler shall be prepared to receive multiple reports with different OIDs (TXA-12 Document Unique Identifier) for the same order number (see 4.7.4.1.3).

4.8.4.2 Report Reference Update Submission

1200 This transaction relates to the Report Reference Update Submission transaction between the Report Manager or Integrated Report Manager/Repository, Department System Scheduler/Order Filler and the Enterprise Report Repository in the above interaction diagram.

4.8.4.2.1 Trigger Event

1205 The Report Manager or Integrated Report Manager/Repository has determined that a changed report is to be made available to the enterprise, and it has guaranteed long term storage of the report in the department by forwarding the report to the Report Repository. For a transaction to the Enterprise Report Repository, the Enterprise Report Repository must support the BY-REFERNCE REPORTS option.

4.8.4.2.2 Message Semantics

1210 The transaction shall be an HL7 V2 MDM^T09 message. Refer to the HL7 2.5 Standard for general message semantics.

Table 4.7-10: IHE Profile – Report Reference Update Submission MDM Message

MDM^T09	Document Replacement Notification	Chapter in HL7 2.6	Comment
MSH	Message Header	2	
EVN	Event Type	3	
PID	Patient Identification	3	
PV1	Patient Visit	3	
ORC	Order Common	4	
OBR	Order detail	4	
TXA	Document Notification	9	

1215 Except as provided below, the content of this message is identical to that of the MDM^T01 message specified in 4.8.4.1.1.

4.8.4.2.2.1 TXA Segment

Table 4.7-11: IHE Profile - TXA Segment with Reference to a Report

SEQ	LEN	DT	OPT	Rep/#	TBL#	ITEM#	ELEMENT NAME
1	4	SI	R			00914	Set ID- TXA
2	30	IS	R		See table 4.7-9a	00915	Document Type
3	2	ID	C			00916	Document Content Presentation
5	250	XC N	C	Y		00918	Primary Activity Provider Code/Name

SEQ	LEN	DT	OPT	Rep/#	TBL#	ITEM#	ELEMENT NAME
7	26	DT M	C			00920	Transcription Date/Time
11	250	XC N	C	Y		00924	Transcriptionist Code/Name
12	70	EI	R			00925	Unique Document Number
13	70	EI	RE			00926	Parent Document Number
14	122	EI	RE	Y		00216	Placer Order Number
15	122	EI	RE			00217	Filler Order Number
16	30	ST	RE			00927	Unique Document File Name
17	2	ID	RE		See table 4.7-10	00928	Document Completion Status
21	30	ST	C			00933	Document Change Reason
22	250	PPN	RE	Y		00934	Authentication Person, Time Stamp

Adapted from the HL7 Standard, version 2.6

1220 TXA-13 Parent Document shall contain the OID of the document being replaced.

4.8.4.2.3 Expected Actions

The Enterprise Report Repository shall replace the existing document, identified in TXA-13 of the MDM^T09, with the new document, and make the report available to other systems in the Enterprise, in a manner outside the scope of this transaction.

1225 The Department System Scheduler/Order Filler can use the information in the CARD-8 message to determine when to send an Order Complete message (ORM with status CM) to the Order Placer.

4.9 Encapsulated Report Storage [CARD-9]

1230 This section corresponds to Transaction CARD-9 of the IHE Technical Framework. Transaction CARD-9 is used by the Report Manager and Report Repository actors.

4.9.1 Scope

In the Encapsulated Report Storage transaction, the Report Manager transmits a DICOM Encapsulated PDF or Encapsulated CDA to the Report Repository for persistent storage. Alternatively, the encapsulated report may be sent from an EHR-S to an Image Archive.

1235 **4.9.2 Use Case Roles**

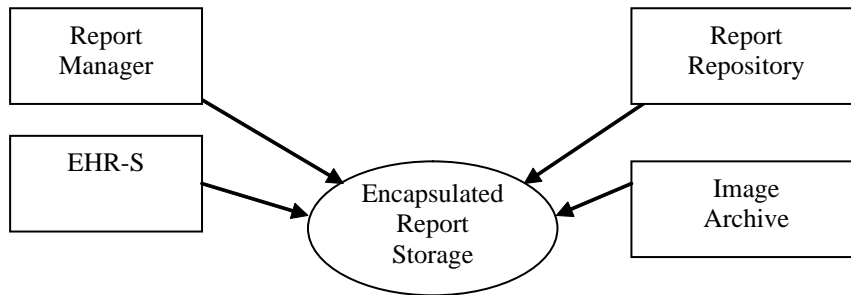

Actor: Report Manager

Role: Transmit reports to Report Repository.

Actor: EHR-S

1240 **Role:** Transmit reports to Report Repository.

Actor: Report Repository

Role: Accept and store DICOM Encapsulated PDF and Encapsulated CDA reports.

Actor: Image Archive

Role: Accept and store DICOM Encapsulated PDF and Encapsulated CDA reports.

1245 **4.9.3 Referenced Standards**

DICOM 2009 PS 3.4: Encapsulated PDF and Encapsulated CDA Storage SOP Classes

4.9.4 Interaction Diagram

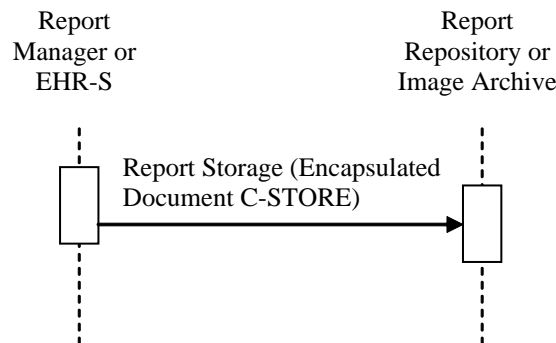

1250 **4.9.4.1 Report Storage**

This transaction relates to the “Report Storage (Encapsulated Document C-STORE)” event between the Report Manager or EHR-S and the Report Repository or Image Archive in the above interaction diagram.

4.9.4.1.1 Trigger Events

1255 When the Report Manager or EHR-S has determined that a report is to be permanently stored, it shall encapsulate the PDF or CDA report in a DICOM Instance and forward the report to the Report Repository or Image Archive.

4.9.4.1.2 Message Semantics

1260 The Report Manager or EHR-S uses the DICOM C-STORE message to transfer DICOM Encapsulated PDF and Encapsulated CDA objects. If the document was received through the Encapsulated Report Submission [CARD-7] transaction, the SOP Instance UID of the DICOM Instance shall be the report OID encoded in the TXA-12 Unique Document Number field in the MDM message of Transaction CARD-7.

1265 The Report Manager or EHR-S shall assign values to all Type 1 attributes of the Encapsulated Document Instance, in accordance with the DICOM Standard, based on fields in the MDM message of Transaction CARD-7 where applicable. The Report Manager or EHR-S shall also assign values to Type 2 attributes that have values available from appropriate fields in the CARD-7 transaction.

1270 The Encapsulated Document Instance shall include the attributes shown in table 4.9-1 with the semantics as defined. Other attributes may be required depending on the content (e.g., (0008,0005) Specific Character Set for a non-ASCII patient name). Type 2 and 3 attributes with a mapping from HL7 shall be filled if the corresponding HL7 field has a value.

Table 4.9-1: Encapsulated PDF and Encapsulated CDA IOD Attributes

Attribute Name	Tag	Type	Description
SOP Class UID	(0008,0016)	1	For PDF: 1.2.840.10008.5.1.4.1.1.104.1 For CDA: 1.2.840.10008.5.1.4.1.1.104.2
SOP Instance UID	(0008,0018)	1	Populate from TXA-12
Study Date	(0008,0020)	2	
Content Date	(0008,0023)	2	Populate from TXA-7 YYYYMMDD
Study Time	(0008,0030)	2	
Content Time	(0008,0033)	2	Populate from TXA-7 HHMMSS.FFFF to resolution present in TXA-7
Acquisition Datetime	(0008,002A)	3	Populate Acquisition Datetime from OBR-7
Accession Number	(0008,0050)	2	Populate from ORC-3
Modality	(0008,0060)	1	If the report manager does not know the value, the value shall default to DOC (see note)
Manufacturer	(0008,0070)	2	Producer of the system that creates the DICOM instance (not the original document).
Referring Physician's Name	(0008,0090)	2	
Patient Name	(0010,0010)	2	Populate Patient Name from PID-5

Attribute Name	Tag	Type	Description
Patient ID	(0010,0020)	2	Populate Patient ID from PID-3.1
Issuer of Patient ID	(0010,0021)	3	Populate from PID-3.4.1
Patient's Birth Date	(0010,0030)	2	Populate from PID-7
Patient's Sex	(0010,0040)	2	Populate from PID-8
Other Patient IDs Sequence	(0010,1002)	3	Populate from second and subsequent repetition values of PID-3, if present
Study Instance UID	(0020,000D)	1	Populate Study Instance UID from OBX-5
Series Instance UID	(0020,000E)	1	The Report Manager or EHR-S shall generate this value
Study ID	(0020,0010)	2	
Series Number	(0020,0011)	1	The Report Manager or EHR-S shall generate this value
Instance Number	(0020,0013)	1	The Report Manager or EHR-S shall generate this value
Burned In Annotation	(0028,0301)	1	Indicates whether or not the encapsulated document contains sufficient burned in annotation to identify the patient and date the data was acquired (This is always the case for report content). Enumerated Value: YES
Verification Flag	(0040,A493)	3	Indicates whether the Encapsulated Document is Verified. Enumerated Values: UNVERIFIED = Not attested by a legally accountable person; corresponds to an HL7 TXA-17 Document Completion Status value other than "LA". VERIFIED = Attested by a Verifying Observer or Legal Authenticator who is accountable for its content; corresponds to an HL7 TXA -17 Document Completion Status value "LA"
Concept Name Code Sequence	(0040,0A43)	2	Populate Document Title as Code Sequence from OBX-3
HL7 Instance Identifier	(0040,E001)	1C	For PDF: not used For CDA: the ClinicalDocument,id element
Document Title	(0042,0010)	2	Populate Document Title from OBX-3
Document Class Code Sequence	(0040, E008)	3	Populate from TXA-2, with Coding Scheme Designator value "HL70270"
Encapsulated Document	(0042,0011)	1	For PDF: Translate OBX-5.5 by unencoding from base64 to PDF binary For CDA: Copied from OBX-5.5, with restoration of HL7v2 escaped characters
MIME Type of Encapsulated Document	(0042,0012)	1	For PDF: application/PDF For CDA: text/xml

Attribute Name	Tag	Type	Description
List of MIME Types	(0042,0014)	1C	For PDF: not used For CDA: List of mediaType element values for all observationMedia entries in the CDA

1275

Notes: 1. A Modality code of ECG may be appropriate for ECG Reports (LOINC code 11524-0) that include a rendered electrocardiogram, e.g., a PDF as specified in the Retrieve ECG Document for Display [CARD-6] transaction.

4.9.4.1.3 Expected Actions

1280 The Report Repository or Image Archive shall support Level 2 (Full) storage, which means all DICOM Type 1, 2 and 3 attributes (public and private) are stored.

The Report Repository or Image Archive shall store the received DICOM Encapsulated PDF and Encapsulated CDA objects. It shall make them available for query and retrieve.

1285

Note: The Report Repository in the DRPT Profile is grouped with the RID Profile Information Source actor. The list of available reports is made available using transaction ITI-11 Retrieve Specific Info for Display, and the PDF or CDA content is made available for retrieve using transaction ITI-12 Retrieve Document for Display. The Retrieve Document for Display transaction provides the document content only, not the encapsulation of the document in the DICOM Instance.

1290

The ITI-11 requestType values supported by the Information Source (Report Repository) are not specified by this transaction. The Report Repository may classify reports by their title to respond to different requestTypes, e.g., CT Head Report (LOINC code 11539-4) and MRI Report (LOINC 18755-9) would be included in a response to the SUMMARY-RADIOLOGY requestType, while Cardiac Catheterization Report (LOINC 18745-0) and Echocardiography Report (LOINC 11522-0) would be included in a response to the SUMMARY-CARDIOLOGY requestType. Document Class Code Sequence (0040,E008) provides a mechanism for conveying the TXA-2 document classification, which may be used with table 4.7-9a to map to a RID requestType.

1295

4.10 Encapsulated Report Query [CARD-10]

1300 This section corresponds to Transaction CARD-10 of the IHE Technical Framework.
Transaction CARD-10 is used by the Report Reader and Report Repository actors.

4.10.1 Scope

In the Encapsulated Report Query Transaction, the Report Reader queries the Report Repository for DICOM Encapsulated Document Reports.

4.10.2 Use Case Roles

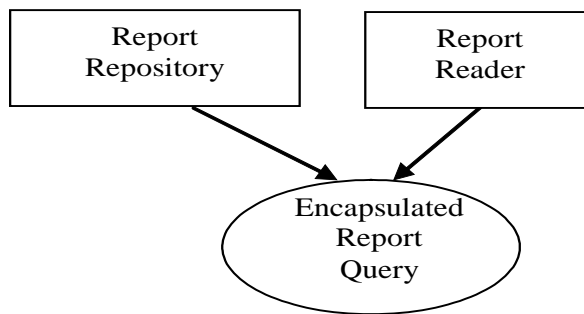

1305

Actor: Report Repository

Role: Responds to queries for DICOM Encapsulated Document Reports.

Actor: Report Reader

1310 **Role:** Queries Report Repository for DICOM Encapsulated Document Reports and makes them available for selection.

4.10.3 Referenced Standards

DICOM 2009 PS 3.4: Query/Retrieve Service Class

4.10.4 Interaction Diagram

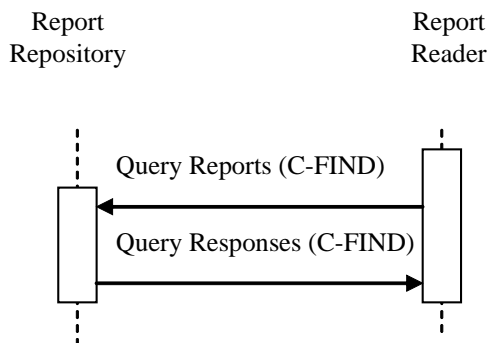

1315

4.10.4.1 Query Reports

This transaction relates to the query section of the above interaction diagram. The Query (Study Root – FIND and optionally Patient Root – FIND) SOP Classes will be supported. Refer to DICOM 2009 PS 3.4: Query/Retrieve Service Class for detailed descriptive semantics.

1320 Note: This Transaction is used in the DRPT Profile only by a Report Repository that supports the DICOM Storage Option.

4.10.4.1.1 Trigger Events

The user at the Report Reader wishes to view selected reports.

4.10.4.1.2 Message Semantics

1325 The message semantics are defined by the DICOM Query/Retrieve SOP Classes.

A C-FIND Request from the DICOM Study Root Query/Retrieve Information Model – FIND SOP Class or the DICOM Patient Root Query/Retrieve Information Model – FIND SOP Class shall be sent from the Report Reader to the Report Repository.

1330 The Report Reader uses one or more matching keys as search criteria to obtain the list of matching entries in the Report Repository at the selected level (Patient & Study/Series/Instance).

1335 In addition to the required and unique keys defined by the DICOM Standard, the IHE Technical Framework has defined matching and return keys to be supported by query SCUs and SCPs. The keys are defined in RAD-TF 2: 4.14.4.1.2, Table 4.14-1. The conventions for key usage are defined in section 2.2. For the Report Reader (SCU) and the Report Repository (SCP) the additional Encapsulated Document Instance specific keys are defined in table 4.10-1.

Table 4.10-1: Encapsulated Document Instance Specific Query Matching and Return Keys

Attribute Name	Tag	Query Keys Matching		Query Keys Return	
		SCU	SCP	SCU	SCP
Encapsulated Document Instance Specific Level					
Verification Flag	(0040,A493)	R+	R+	R+	R+
Content Date	(0008,0023)	O	O	O	R+
Content Time	(0008,0033)	O	O	O	R+
Concept Name Code Sequence	(0040,A043)	R+	R+	R+	R+
>Code Value	(0008,0100)	R+	R+	R+	R+
>Coding Scheme Designator	(0008,0102)	R+	R+	R+	R+
>Coding Scheme Version	(0008,0103)	O	O	O	R+
>Code Meaning	(0008,0104)	O	O	R+	R+
Document Title	(0042,0010)	O	O	R+	R+

4.10.4.1.3 Expected Actions

1340 The Report Repository receives the C-FIND request, performs the matching on the provided keys and sends the list of matching records back to the Report Reader via C-FIND responses.

Note: See discussion of expected actions for Query in RAD-TF 2: 4.14.4.1.3.

4.11 Encapsulated Report Retrieve [CARD-11]

1345 This section corresponds to Transaction CARD-11 of the IHE Technical Framework.
Transaction CARD-11 is used by the Report Reader and Report Repository actors.

4.11.1 Scope

In the Retrieve Reports Transaction, the requested DICOM Encapsulated PDF or Encapsulated CDA Reports are transferred from the Report Repository to the Report Reader for viewing.

4.11.2 Use Case Roles

1350

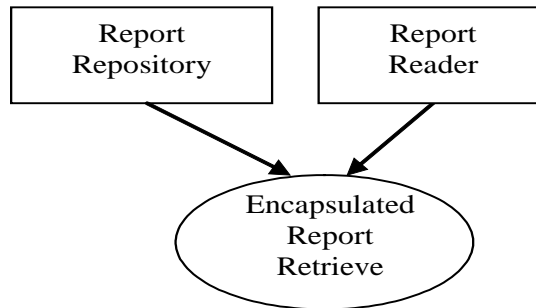

Actor: Report Repository

Role: Sends requested DICOM Encapsulated PDF or Encapsulated CDA Reports to Report Reader.

1355 **Actor:** Report Reader

Role: Retrieves DICOM Encapsulated PDF or Encapsulated CDA Reports from Report Repository and makes them available for viewing.

4.11.3 Referenced Standards

DICOM 2009 PS 3.4: Query/Retrieve Service Class

1360 DICOM 2009 PS 3.4: Storage SOP Class

4.11.4 Interaction Diagram

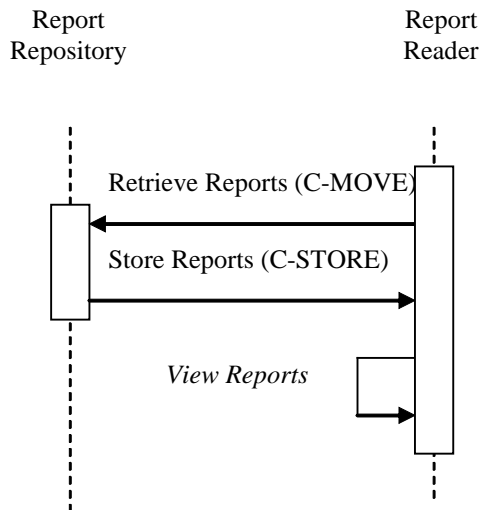

4.11.4.1 Retrieve Reports

1365 This transaction relates to the retrieve section of the above interaction diagram. The Retrieve (Study Root – MOVE and optionally Patient Root – MOVE) SOP Classes shall be supported. The Report Reader as an SCP and the Report Repository as an SCU shall support the DICOM Encapsulated PDF and Encapsulated CDA Storage SOP Classes. Refer to DICOM PS 3.4, Annex C, for detailed descriptive semantics.

1370 Note: This Transaction is used in the DRPT Profile only by a Report Repository that supports the DICOM Storage Option.

4.11.4.1.1 Trigger Events

The user at the Report Reader selects specific reports to view.

4.11.4.1.2 Message Semantics

1375 The DICOM Query/Retrieve SOP Classes and the DICOM Encapsulated PDF and Encapsulated CDA Storage SOP Classes define the message semantics.

A C-MOVE Request from the DICOM Study Root Query/Retrieve Information Model – MOVE SOP Class or the DICOM Patient Root Query/Retrieve Information Model – MOVE SOP Class shall be sent from the Report Reader to the Report Repository.

1380 4.11.4.1.3 Expected Actions

The Report Repository receives the C-MOVE request, establishes a DICOM association with the Report Reader and uses the DICOM Encapsulated PDF or Encapsulated CDA Storage SOP Class to transfer the requested reports.

4.11.4.2 View Reports

1385 This transaction relates to the “View Reports” event of the above interaction diagram.

4.11.4.2.1 Trigger Events

The Report Reader receives reports from the Report Repository.

4.11.4.2.2 Invocation Semantics

1390 This is a local invocation of functions at the Report Reader to initiate display of the encapsulated PDF or CDA report data.

4.11.4.2.3 Expected Actions

The Report Reader presents to the user the encapsulated report document in accordance with the requirements of the PDF or CDA specification.

1395 CDA documents may reference a stylesheet by URL. If the URL is accessible to the Report Reader, it shall be used for rendering the CDA document.

Add the following new appendices

Appendix D: Coded Report Titles

1400 Table D-1 shows examples of LOINC coded report titles that are appropriate for cardiology and radiology studies. This is not an exhaustive list, and LOINC may continue to add new report titles.

Note: This table is similar to DICOM Context Group 7000.

1405

Table D-1: Example LOINC Report Titles

Coding Scheme Designator	Code Value	Code Meaning
LN	18745-0	Cardiac Catheterization Report
LN	18750-0	Cardiac Electrophysiology Report
LN	18747-6	CT Report
LN	11540-2	CT Abdomen Report
LN	11538-6	CT Chest Report
LN	11539-4	CT Head Report
LN	18748-4	Diagnostic Imaging Report
LN	11522-0	Echocardiography Report
LN	11524-0	ECG Report
LN	18752-6	Exercise Stress Test Report
LN	18754-2	Holter Study Report
LN	18755-9	MRI Report
LN	11541-0	MRI Head Report
LN	18756-7	MRI Spine Report
LN	18757-5	Nuclear Medicine Report
LN	18758-3	PET Scan Report
LN	11528-7	Radiology Report
LN	18760-9	Ultrasound Report
LN	11525-3	Ultrasound Obstetric and Gyn Report