

## Integrating the Healthcare Enterprise



5

# IHE Patient Care Coordination (PCC) Technical Framework Supplement

10

## Perinatal Workflow (PW)

15

## Trial Implementation

Date: August 30, 2010

Author: Keith W. Boone

Email: [pcc@ihe.net](mailto:pcc@ihe.net)

20

## Foreword

This is a supplement to the IHE Patient Care Coordination Technical Framework V6.0. Each supplement undergoes a process of public comment and trial implementation before being incorporated into the volumes of the Technical Frameworks.

- 25 This supplement is submitted for Trial Implementation as of August 30, 2010 and will be available for testing at subsequent IHE Connectathons. The supplement may be amended based on the results of testing. Following successful testing it will be incorporated into the Patient Care Coordination Technical Framework. Comments are invited and may be submitted on the IHE forums at <http://forums.rsna.org/forumdisplay.php?f=309> or by email to [pcc@ihe.net](mailto:pcc@ihe.net).
- 30 This supplement describes changes to the existing technical framework documents and where indicated amends text by addition (**bold underline**) or removal (~~**bold strikethrough**~~), as well as addition of large new sections introduced by editor’s instructions to “add new text” or similar, which for readability are not bolded or underlined.
- 35 “Boxed” instructions like the sample below indicate to the Volume Editor how to integrate the relevant section(s) into the relevant Technical Framework volume:

<i>Replace Section X.X by the following:</i>
--

General information about IHE can be found at: [www.ihe.net](http://www.ihe.net)

- 40 Information about IHE Patient Care Coordination can be found at:  
<http://www.ihe.net/Domains/index.cfm>

Information about the structure of IHE Technical Frameworks and Supplements can be found at:  
<http://www.ihe.net/About/process.cfm> and <http://www.ihe.net/profiles/index.cfm>

- 45 The current version of the IHE Technical Framework can be found at:  
[http://www.ihe.net/Technical\\_Framework/index.cfm](http://www.ihe.net/Technical_Framework/index.cfm)

**CONTENTS**

	Introduction .....	4
50	Open Issues and Questions .....	5
	Closed Issues .....	5
	<b>Volume 1 – Integration Profiles .....</b>	<b>7</b>
	2.5 Dependencies among Integration Profiles .....	7
	2.2.X Perinatal Workflow (PW) Integration Profile .....	8
55	2.7 History of Annual Changes .....	8
	X Perinatal Workflow (PW) Integration Profile .....	8
	X.1 Purpose and Scope .....	8
	X.2 Process Flow .....	9
	X.2.1 Use Cases .....	11
60	X.2.2 Diagrams .....	15
	X.3 Actors/ Transactions.....	22
	X.3.1 Patient Registration .....	24
	X.3.2 Health Information Exchange.....	24
	X.3.3 Personal Health Record .....	24
65	X.3.4 Care Manager Actor .....	24
	X.3.5 Order Placer .....	25
	X.3.6 Imaging Order Filler.....	25
	X.3.7 Laboratory Order Filler .....	26
	X.3.8 Enterprise Report Repository .....	26
70	X.3.9 Device Observation Consumer / Alarm Manager .....	26
	X.3.10 Device Gateway .....	26
	X.3.11 Form Manager .....	26
	X.3.12 Form Receiver .....	27
	X.3.13 Decision Support Service .....	27
75	X.3.14 Device Observation Reporter .....	27
	X.4 Perinatal Workflow (PW) Integration Profile Options .....	30
	X.4.1 Patient Registration Option .....	31
	X.4.2 Obstetrics Option.....	31
	X.4.3 Labor and Delivery Option.....	31
80	X.4.4 Newborn Care Option .....	31
	X.4.5 Content Creator Option .....	32
	X.4.6 Imaging Data Option .....	32
	X.4.7 Administrative Services Option .....	32
	X.4.8 Clinical Decision Support .....	32
85	X.5 Perinatal Workflow (PW) Security Considerations .....	32
	X.5.1 Misidentified Patient .....	32
	X.5.2 Malicious attempts to obtain patient information.....	33
	X.5.3 Accidental Release of Protected Health Information .....	33
	X.5.4 Inability to Communicate Orders due to System Failure or Malicious Attack.....	33
90	X.5.5 Inappropriate Communication of Mother / Child Identity in Adoption Cases.....	34

	X.5.6 Externally sourced data may be inaccurate or unreliable.....	34
	X.7 Content Modules .....	34
	X.7.1 Antepartum Folder .....	34
	X.7.2 Labor and Delivery Folder .....	35
95	Glossary .....	36
	<b>Volume 2 - Transactions.....</b>	<b>39</b>
	3.0 Exchange Content .....	40
	3.0.1 Scope .....	40
	3.0.2 Use Case Roles .....	40
100	3.0.3 Referenced Standard .....	40
	3.0.4 Interaction Diagram.....	40
	6.2 Folder Specifications.....	43
	6.2.A Antepartum Folder Specification.....	44
	6.2.L Labor and Delivery Folder Specification.....	45
105	6.2.N Newborn Folder Specification .....	46
	6.2.P Postpartum Folder Specification.....	47

110

## Introduction

This supplement defines the Perinatal Workflow (PW) profile provided for Trial Implementation. It is written as changes to the documents listed below. The reader should have already read and understood these documents:

- 115
1. [PCC Technical Framework Volume 1, Revision 6.0](#)
  2. [PCC Technical Framework Volume 2, Revision 6.0](#)

This supplement also references other documents<sup>1</sup>. The reader should have already read and understood these documents:

- 120
1. [IT Infrastructure Technical Framework Volume 1, Revision 7.0](#)
  2. [IT Infrastructure Technical Framework Volume 2, Revision 7.0](#)
  3. [The Patient Identifier Cross-Reference \(PIX\) and Patient Demographic Query \(PDQ\) HL7 v3 Supplement to the IT Infrastructure Technical Framework.](#)
  4. [Radiology Technical Framework: Volume 1 Integration Profiles, Revision 9.0](#)
  5. [Radiology Technical Framework: Volume 2 Transactions, Revision 9.0](#)

125

  6. [Radiology Technical Framework: Volume 3 Transactions \(continued\), Revision 9.0](#)
  7. [Laboratory Technical Framework: Volume 1, Integration Profiles, Revision 2.1](#)
  8. [Laboratory Technical Framework: Volume 2, Transactions, Revision 2.1](#)
  9. [Laboratory Technical Framework: Volume 3, Content, Revision 2.1](#)
  10. HL7 and other standards documents referenced in the technical frameworks above.

130

  11. Dilbert 2.0: 20 Years of Dilbert by Scott Adams, ISBN-10: 0740777351, ISBN-13: 978-0740777356

This profile principally updates Volume 1 of the IHE PCC Technical Framework and references transactions, content profiles and Actors from other IHE domains, including IT Infrastructure, Laboratory, Patient Care Devices, Quality, Research and Public Health, and Radiology.

---

<sup>1</sup> The first nine documents can be located on the IHE Website at [http://www.ihe.net/Technical\\_Framework/index.cfm#IT](http://www.ihe.net/Technical_Framework/index.cfm#IT). The remaining documents can be obtained from their respective publishers.

## 135 **Open Issues and Questions**

1. An episode of care identifier is needed for folders used in this profile. How should that episode of care identifier be conveyed in XDS Metadata? How will encounters versus episodes of care be differentiated? I understand there will be different folders for each encounter in L&D.(see p. 7 ) We need to address the overall episode of care (the pregnancy).
2. LOINC Submissions are needed for X-Newborn Records, and X-Postpartum Records. LOINC code for Antepartum Records is 57082-0. LOINC Codes need to be requested for X-Newborn Records and X-Postpartum Records
3. The LOINC Code used for the Labor and Delivery Folder (15508-5 Labor and Delivery Records) is presently the same as is used for the Labor and Delivery Summary. We will need advice from LOINC on what the right codes are to use. The Labor and Delivery folder is correctly identified as 15508-5. The Labor and Delivery Summary is 57057-2.

## **Closed Issues**

1. It isn't clear which transaction should be used for ADT. Should it be ITI-8 (PIX), ITI-30 (PAM), LAB-1 (LTW) or RAD-1 (SWF) or some combination thereof. I would recommend PAM. ITI Recommended us of PAM, so we are using ITI-30.
2. The Section Import Option is rarely used, should it be referenced as an option for this profile? We will not call out this option.
3. How do we handle exchange of content. Should their be options supporting topology, or should their be a required grouping with actors from XDS, XDR and XDM. I would recommend the latter. We will require systems grouped with XDS, XDR or XDM to support all content in the grouping.
4. Should the Order Filler actor be divided into an Laboratory Order Filler and an Imaging Order Filler actor? Yes
5. Do we need to address care prior to conception (e.g., fertility treatment) in the perinatal episode of care? Care prior to conception is addressed in the Antepartum Folder. These documents may be included in the folder if the care provider deems them relevant.
6. What do we do about patient monitoring in the Labor and Delivery center (e.g, Fetal Heart Monitor). Added the Device Gateway and Remove/Central Viewer Actors.
7. What about Personal Health Records? Added the Personal Health Record Actor.
8. Vital Records need to be addressed in the Newborn Option, question from Mike on National vs. State requirements. Added Forms Manager and Forms Reciever and Vital Records option on Care Manager.

- 170
9. Should PCC-0 Exchange Content require use of PIX/PDQ at least once per patient (as we have been demonstrating annually for the last 5 years)? We will recommend this behavior where needed, but not require it.

## Volume 1 – Integration Profiles

*Add the following to section 2.4*

### 175 2.4 Dependencies among Integration Profiles

*Add the following to Table 2.4-1*

PW	CT	All actors of the PW Profile must be grouped with the Time Client Actor of the CT Profile.	A consistent time base is necessary to ensure accurate logging and security.
PW	APS, APE, APHP, APL, PPVS	A Care Manager Actor implementing the Obstetric Option must demonstrate the ability to be a Content Creator and Content Consumer of these profiles. All Care Managers must demonstrate the ability to implement the View Option of the Content Consumer of these profiles.	Systems designed for obstetric use will support creation of necessary content for providers in those settings, and viewing of all content that may be generated during the pregnancy under this profile.
PW	APE, APL	All Care Managers must demonstrate the ability to implement the View Option of the Content Consumer for these Profiles	Systems designed for obstetric use will support viewing of all content that may be generated during the pregnancy under this profile.
PW	LDHP, LDS, MDS	A Care Manager implementing the Labor and Delivery Option must demonstrate the ability to be a Content Creator of the Labor and Delivery History and Physical (LDHP). All Care Managers must demonstrate the ability to implement the View Option of the Content Consumer for the LDHP profile.	Systems designed for labor and delivery use will support creation of necessary content for providers in those settings, and viewing of all content that may be generated during the pregnancy under this profile.
PW	NDS, NBS	A Care Manager implementing the Newborn Option must demonstrate the ability to be a Content Creator of the Newborn Discharge Summary (NDS). All Care Managers must demonstrate the ability to implement the View option of the Content Consumer of the NDS profile.	Systems designed for labor and delivery use will support creation of necessary content for providers in those settings, and viewing of all content that may be generated during the pregnancy under this profile.
PW	XDS	All Content Creators must support the Folder Management option if used with the XDS Document Source Actor.	Folders are used by this profile to organize episodes of care.



*Add the following section to Section 2.2*

### **2.2.X Perinatal Workflow (PW) Integration Profile**

180 *Error! Reference source not found. Add the following to section 2.7*

## **2.7 History of Annual Changes**

*Add the following bullet to the end of the bullet list in Section 1.7*

- 185 • Added the Perinatal Workflow (PW) profile to simplify exchanges between various providers of perinatal care utilizing profiles and transactions from several IHE domains to support the continuum of care of expectant mothers and newborns.

## **X Perinatal Workflow (PW) Integration Profile**

190 Perinatal workflows involve communication between ambulatory providers, laboratories, imaging facilities, and labor and delivery centers. The Perinatal Workflow profile simplifies exchanges between these various providers of care by utilizing profiles and transactions from several IHE domains to support the continuum of care of expectant mothers and newborns.

### **X.1 Purpose and Scope**

195 Today, a large portion of mothers still arrive at a birthing facility without complete documentation. In a recent U.S. study at one hospital, approximately 70 % of mothers (with paper charts) arrived at the birthing facility without their chart being available. A pregnant mother may find herself at a different hospital than planned due to preterm labor, rapid labor, travel, or being treated by a physician without direct knowledge of her obstetric history due to other circumstances. The information subsequently collected during labor, delivery, and the immediate postpartum period is similarly important and often unavailable for follow-up care for  
200 both mother and infant.

A typical pregnancy duration is approximately 40 weeks. After pregnancy, the new mother usually receives care for at least six more weeks to ensure proper recovery. During this extended period of perinatal care, the mother will receive care from a variety of care providers. The mother's aggregated record of care provides important information for all health care  
205 professionals who are part of her obstetric care team. Availability of key information electronically to all members of the team will significantly enhance patient safety, reduce costs, and increase patient satisfaction. The mother may also incorporate the data from this aggregated record into her own personal health record (PHR).

210 The period of perinatal care constitutes an episode of care that covers the period from conception through delivery of the newborn and finishes at the final postpartum visit. This episode of care is subdivided into three smaller episodes of care.

1. The antepartum period runs from conception to delivery<sup>2</sup>.
2. The labor and delivery period runs from admission for delivery to discharge of the mother.
- 215 3. The postpartum period runs from delivery to the final post partum visit (typically at six weeks).

Each of these periods may include several encounters at various institutions and results in documentation of the services performed within each encounter. Critical information from each of these periods of care will often be needed in the next one.

220 The Antepartum Workflow profile describes the movement of this information through the various healthcare IT systems that consume and produce it. It provides guidelines on what information should be transferred, and rules for how those transfers should occur within information systems. These ensure the interoperable exchange of data necessary to ensure appropriate care continuity.

## 225 **X.2 Process Flow**

During a normal pregnancy, a mother will undergo several encounters in an obstetric setting. These encounters will track the progression of the pregnancy. Diagnostic tests, such as labs and imaging studies will be ordered, and the results incorporated into the record of care for the antepartum period. As the expectant mother nears her delivery date, many of these records will  
230 be shared with the delivery location.

In the delivery setting, the mother will undergo an admission history and physical. The mother and fetus will be monitored as labor progresses and additional diagnostic tests may be ordered. The mother may be placed on an infusion pump. Eventually the delivery will be performed. The baby (or babies in the case of multiple birth) may be monitored, as may the mother post delivery.  
235 A labor and delivery summary will be produced which describes the outcome for both the mother and the newly delivered baby (or babies).

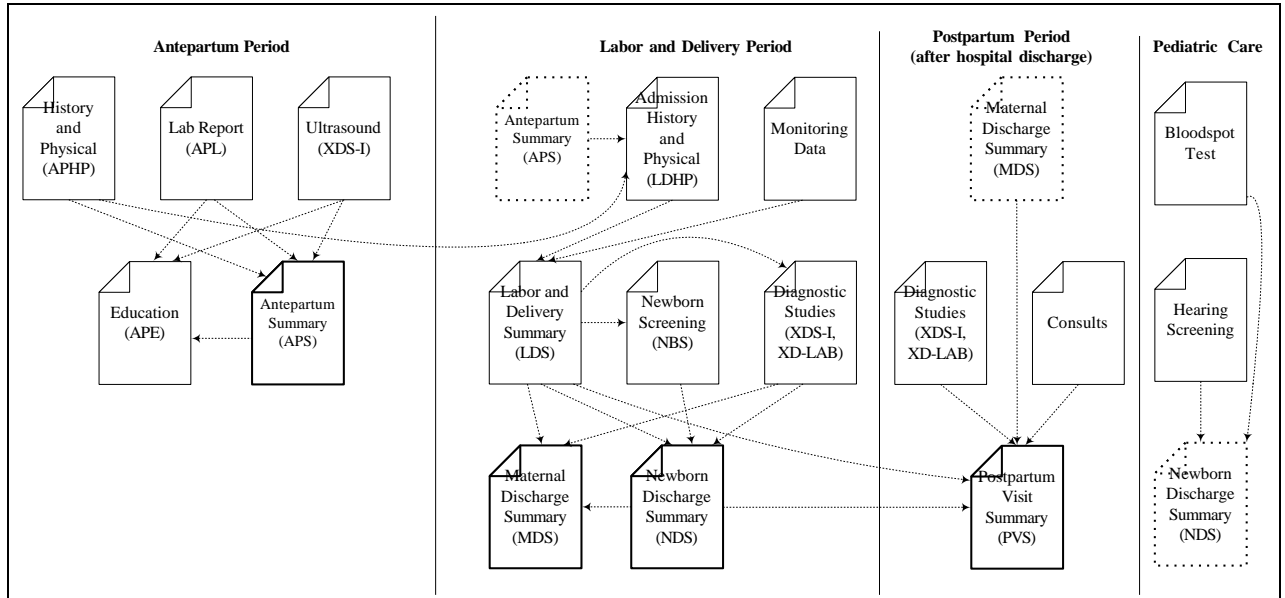
The baby will be admitted, and undergo a more complete evaluation at that time. Additional tests on the newborn will be performed (e.g., the newborn blood spot test and a hearing screening). Vital records data will be collected and sent to the appropriate authorities to issue a certificate of birth. Other consults for lactation, nutrition, and/or social services may also be necessary to for the mother and child. The results of newborn screening tests (and possibly others) will be summarized in the newborn's discharge summary. Finally, the outcome of the delivery will also be summarized in the mother's discharge summary.  
240

After the discharge of the mother from the hospital, she will undergo follow up care, and more diagnostic tests and/ or procedures may be performed. Finally, the mother will complete a final postpartum visit, which will summarize all the events that occurred since delivery.  
245

---

<sup>2</sup> Prior episodes of care related to this period might include fertility treatment or conception and/or genetic counseling. This is not within the scope of this profile.

Figure X-2.1 below provides one non-exhaustive example of these information flows.



**Figure X.2-1 Information Flow**

250 Note that each period of care includes a document that summarizes the care than went on in that period (shown in bold) and supports transfers of care into the next period. This document transfers into the the next period (dotted outline) and is used to supply relevant data during that period of care.

255 Records for each period are maintained in folders in the information exchange. The folders are marked with codes that describe their content. The codes used for these folders are prescribed by each region that implements the profile in National Extensions as different countries use different coding systems to represent these collections of data. IHE recommends a set of codes that may be used, and the codes that are selected by the National Extensions should represent the same concepts. The folders also have textual names that describe the data that they contain.

260 This profile makes some recommendations about the names, but leaves the formal specification of these textual names to be defined by the affinity domain. To ensure patient privacy, patient identifying characteristics should not be used in folder names (e.g., Jane Doe’s First Pregnancy).

265 This profile specifies four folders that are created and used by the information systems used during the antepartum, labor and delivery, and postpartum periods for the mother and the newborn period for the baby. These are specified in PCC TF-2:6.A, 6.L, 6.N and 6.P. These folders must be created at the appropriate times by information systems when they share content. Where possible<sup>3</sup>, these systems first search for a folder of an appropriate type in the Health Information Exchange. If an appropriate folder can be found, it should be verified by the user

<sup>3</sup> The “Health Information Exchange” actor can be implemented using XDS, XDR or XDM. XDS and XDM provide mechanisms to locate existing folders. XDR does not. Note that XDM only provides this capability when adding information to pre-existing media.

270 before new documents are added to it. If an appropriate folder cannot be found the system must create it in the first submission that is exchanged.

### **X.2.1 Use Cases**

In the following uses cases, it has been assumed that all care settings utilize an EHR that participates in a health information exchange and that prior documents related to the mother's pregnancy are accessible in the HIE (1).

#### **275 X.2.1.1 Basic Antepartum Record Use Case**

This use case reflects the course of care during an uncomplicated pregnancy.

##### **Pre-condition**

280 The mother's obstetrician sees her for the initial and subsequent prenatal visits. During the initial and/or subsequent prenatal visits, information is collected and may be updated within the office Electronic Health Record (EHR), these include (but are not limited to):

- Patient demographics
- Menstrual history
- Obstetric history
- 285 • Medical history including surgical history, psych-social history
- Genetic history and screening/Teratology counseling
- Infection history
- Family history
- Initial and subsequent physical examination
- 290 • Medications
- Problems and risk factors for preterm birth
- Allergies and adverse reactions
- Prenatal visit information
- Prenatal laboratory results
- 295 • Documentation of patient education and counseling
- Plans for care

The information collected during the mother's prenatal visits are included in the mother's antepartum record.

##### **Event(s)**

300 *Scenario 1* - At specified times the documents making up the antepartum record are transmitted by the mother's prenatal care provider EHR to the intended facility for delivery.

The intended facility of delivery health information system receives the transmitted records.

*Scenario 2* - At specified times the documents making up the antepartum record are transmitted by the mother's obstetrician EHR to an XDS Registry and Repository.

305 The delivery facility's health information system queries the registry for the mother's antepartum records, and they are then retrieved from the repository by the delivery facility.

**Post-condition**

The received records can be viewed and/or imported into the delivery facilities health information system to facilitate patient care.

310 **X.2.1.2 Antepartum Consultative Care**

This use case reflects an example of perinatologist consultative prenatal care.

**Pre-condition**

315 The mother's prenatal care provider sees the mother for her pregnancy. During the pregnancy, the mother is noted to have a medical problem requiring consultation with a maternal-fetal medicine specialist (perinatologist).

**Events**

320 The mother is seen in the prenatal care provider's office where a complete health history is obtained and recorded in the office EHR and sent to the consultant's EHR. The perinatologist orders laboratory and imaging tests and evaluates the mother. The perinatologist completes and shares a consultation report. The prenatal care provider is able to access this consultation report, as well as the laboratory and imaging reports ordered by the perinatologist. The prenatal care provider reviews the consultation report from the perinatologist's office and imaging studies ordered by the perinatologist along with current recorded data. The prenatal care provider orders additional laboratory studies, and sends the mother for her lab tests.

325 When the laboratory results return, the prenatal care provider completes the admission history and physical, captures the allergies and medications, and includes the data prepared or ordered by the perinatologist, and makes it available to the hospital or birthing facility. This data includes an assessment of the mother's health status, and the requisite data summarized from the antepartum care given. The care team assures the complete collection of documents needed is available and that there is a suitable environment with appropriate support for post-delivery after-care.

**Post-condition**

335 The pre-delivery history and physical, Antepartum Summary, the perinatologist's consultation report, all the Antepartum laboratory and imaging studies, as well as the Antepartum education provided are available to the obstetrician and the hospital or birthing center personnel for incorporation into the care provided and their respective EHRs. These are also available to the mother for viewing and incorporation into her PHR, and into the newborn baby's PHR.

**X.2.1.3 Antepartum Collaborative Care**

This use case reflects two-way transmission of data in an example of collaborative care.

340 **Pre-condition**

A pregnant diabetic mother is seen by her prenatal care provider in the office for prenatal care. An ultrasound is performed to determine gestational age. The mother is sent to a consultant as a high-risk mother. Her prenatal care provider transmits labs and anticipated route of delivery to the consultant and/or hospital birthing facility.

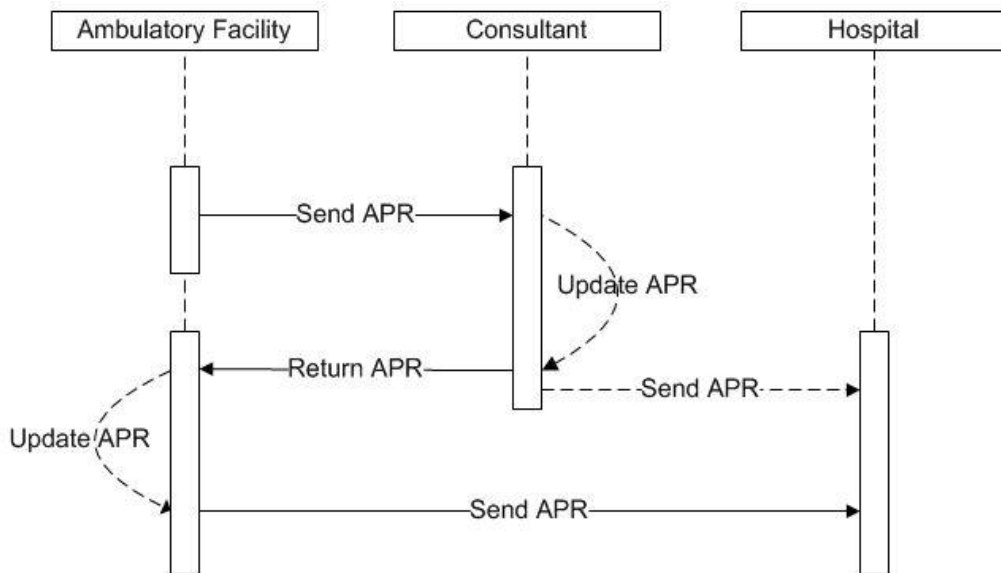
345 **Events**

The mother returns to her consultant biweekly for blood testing and ultrasounds (when necessary) in addition to regular obstetric visits. The consultant reports back to the obstetrician after each visit. Complete history and physical, imaging, and additional labs are performed during mother’s regular visit with her prenatal care provider.

350 The mother arrives at birthing facility. Prenatal care provider completes the admission history and physical, allergies, medications, and includes the data prepared or ordered by the consultant, and makes it available to the hospital birthing facility. This data includes an assessment of the mother’s health status, and the requisite data summarized from the antepartum care given. The care team documents that the complete collection of documents required is available.

355 **Post-condition**

The mother’s obstetric care provider delivers by cesarean section after anesthesia. The care team assures that there is a suitable environment with appropriate support for post-delivery after-care. Delivery information, (e.g. birth weight, APGAR scores, type of delivery, etc.) is available for pediatrician. The mother’s postpartum record is sent to the consultant for incorporation into the mother’s record. The mother can incorporate the history and physical into her own PHR and the newborn’s records into the newborn's PHR.



**Figure X.2.1.3-1 Antepartum Record Process Flow**

365 This process flow diagram above shows the movement of the antepartum record over the course of care for a pregnancy involving an ambulatory facility (obstetric provider), consultant, and

hospital (birthing facility). This diagram specifically excludes other infrastructure interactions for simplicity and readability. These infrastructure interactions may be found elsewhere in the framework.

370 Data from the mother’s prenatal care aggregates into her electronic antepartum summary by the obstetric provider. The antepartum summary is then sent to a consultant who updates the antepartum summary, and returns it to the obstetric provider. The electronic antepartum summary is then sent to the birthing facility at the appropriate time(s). The consultant may also send the antepartum summary directly to the hospital.

### **X.3.3.2 Complex Delivery**

#### **375 Events**

A 36+ week multiparous pregnant woman moves to the area and establishes care with a new obstetrician. The woman had a Group B Streptococcus test performed by her previous obstetrician just before moving (2).

The obstetrician reviews existing documents, which include:

- 380
- Positive results of the Group B streptococcus culture.
  - Prenatal ultrasounds and a consult report indicating that a lung mass is a small congenital cystic adenomatoid malformation, and has regressed over the course of the pregnancy. Here prior care provider has deemed it unlikely to cause any respiratory compromise at birth.

385 Her obstetric care provider reviews the lab results and informs the mother she will need antibiotics during labor to prevent transmitting Group B Streptococcus to her baby.

390 On Saturday, she has a rapid onset of labor at 37 weeks gestation, rushes to the local birthing center, and rapidly delivers an infant 3 hours after arrival, with an APGAR score of 5 at 1 minute, and a score of 8 at 5 minutes. The mother, aware of the positive Group B Streptococcus result, tells the nurse of her need for antibiotics. The nurse verifies the culture results and administers penicillin per protocol. As the mother’s negative hepatitis B surface status is known, the baby is not given hepatitis B immune globulin. Her Rh-negative status is also known (3, 4).

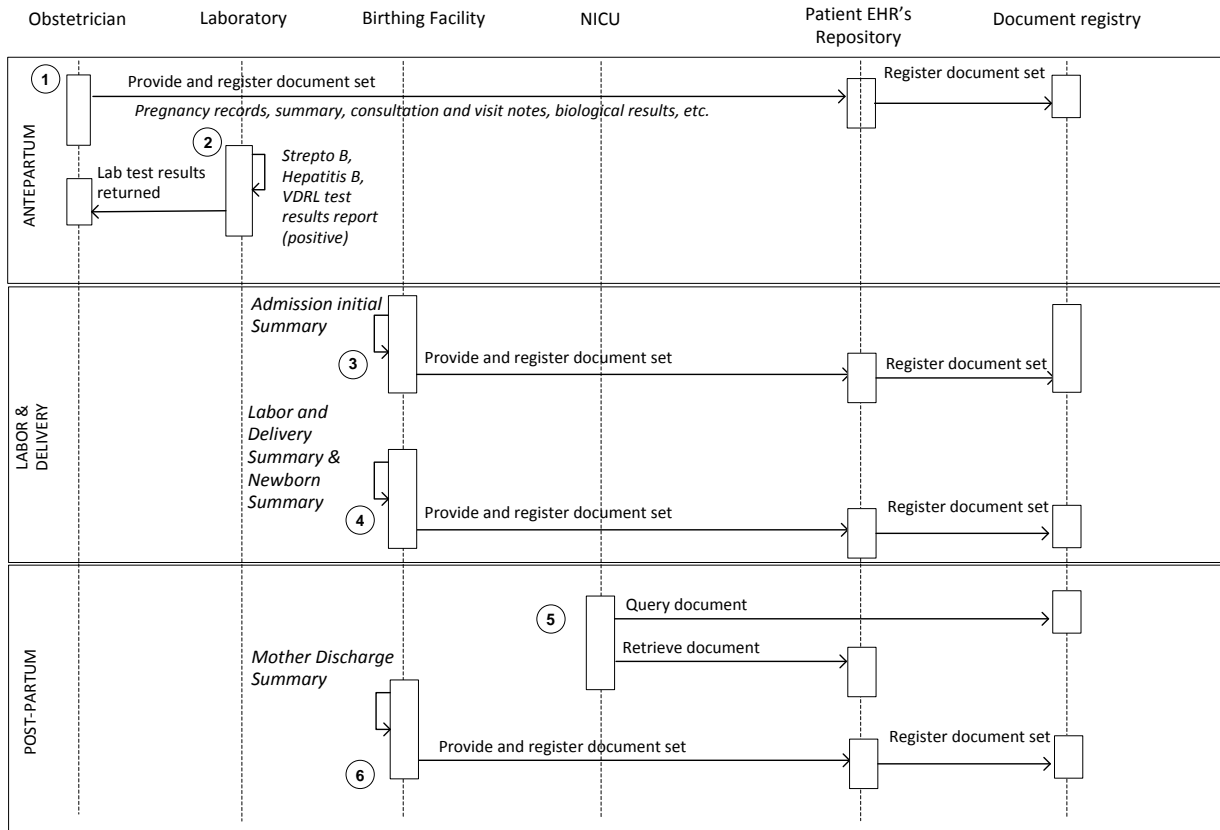
395 The neonate shows signs of respiratory distress. The pediatrician consults with the on-call neonatologist at the regional NICU, who reviews the labor and delivery summary (5). As the baby delivered less than 3 hours after receiving antibiotics for Group B Streptococcus prophylaxis, there is early suspicion of early onset Group B Streptococcal pneumonia and/ or sepsis. The neonatologist has the pediatrician initiate a sepsis work up and begins intravenous antibiotics and arranges for transport to the regional NICU. Because of the unavailability of Special Care Nursery services at the birthing center, the infant is transported to the nearest NICU  
400 five miles away. Antibiotics are continued at the NICU.

When the mother's obstetric care provider calls the NICU the next morning, she is extremely happy to hear that evaluation and treatment were initiated immediately and the baby is doing fine.

The mother and the newborn are discharged and a maternal discharge summary is created (6).

405 **Post Conditions**

Several opportunities for performing unnecessary treatment (1), repeated testing (2), extended hospitalization, or further complications (5) due to inaccessible information (2, 4) are avoided.



**Figure X.3-1 Basic Process Flow in LDR Profile - Desired Situation**

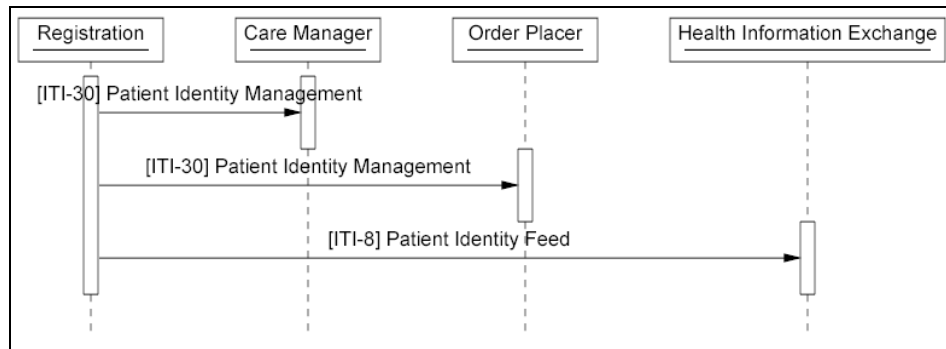
410 **X.2.2 Diagrams**

Figure X.3-1 shows the basic flows expected in the Perinatal Workflow profile. The registration actor performs registration and updates of mother information. These updates can be sent to the Care Manager, Order Placer, Order Filler, or Health Information Exchange.

**X.2.2.1 Registration**

415 Registration of the mother can occur in the obstetric or labor and delivery setting, or in the Health Information exchange prior to, or during the mother's first visit to the organization providing perinatal care.

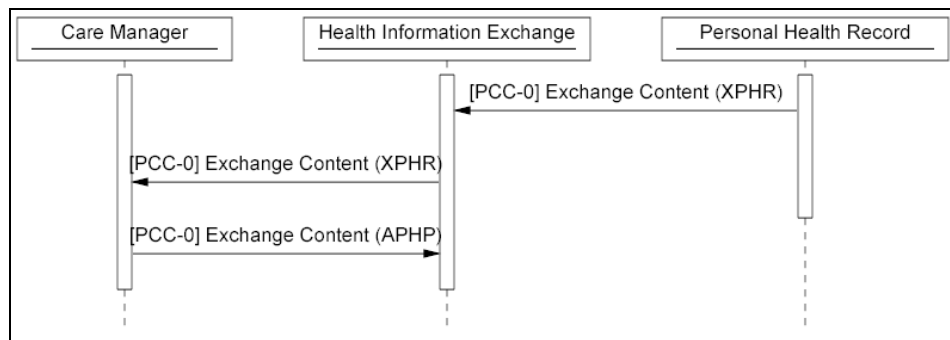




**Figure X.2.2.1-1 Registration Process Flow**

420 **X.2.2.2 Initial Visit**

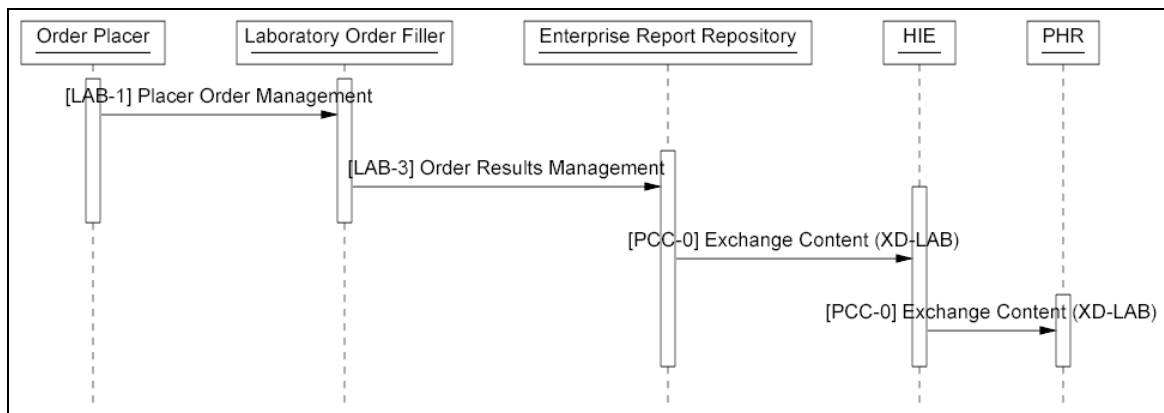
During the initial obstetric visit the healthcare provider will examine the new mother, generating a history and physical. Information about the date of conception and last menstrual period is gathered to help in estimating the date of delivery and the gestational age of the fetus. This information may be supplemented by the mothers PHR.



425

**Figure X.2.2.2-1 Initial Visit H&P Process Flow**

An initial panel of prenatal lab tests may be ordered. When the results are returned, the provider will notify the mother of the result. The provider will share this lab result in the healthcare exchange and the new mother can look at the result online.

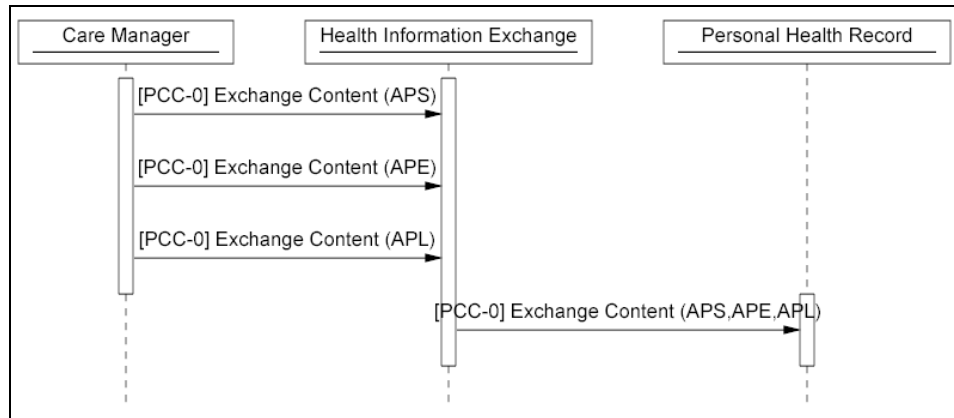


430

**Figure X.2.2.2-2 Pregnancy Test Process Flow**

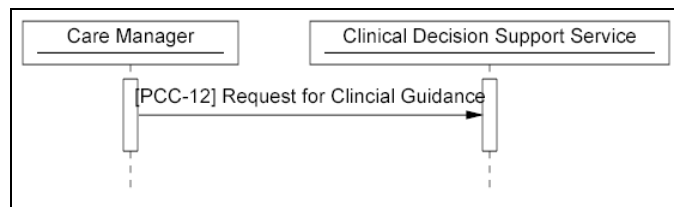
### X.2.2.3 Prenatal Care

As the pregnancy progresses, the mother will meet with a clinician in the obstetric providers office periodically to review the progress of the pregnancy. Additional laboratory tests will be ordered, and the results will be reported back to the obstetric provider. The results will also be added to the mother's antepartum summary and antepartum labs. The mother will be educated on birthing procedures and laboratory testing and results. The antepartum education report will also be produced.



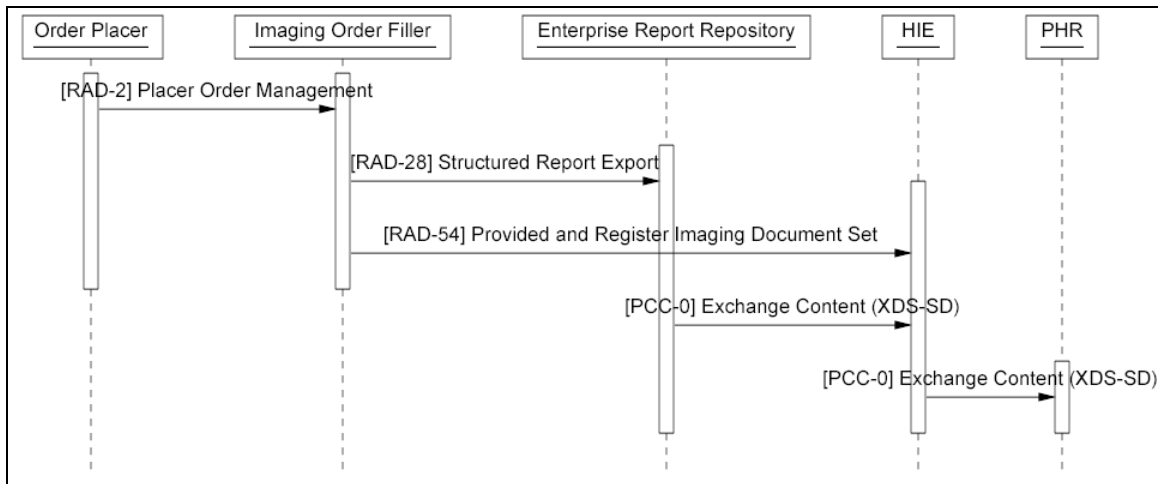
440 **Figure X.2.2.3-1 subsequent Visit Process Flow**

A clinical decision support system may be used to help in the evaluation of the results of some of these laboratory tests (e.g., in the case of genetic tests), or to identify specific immunizations that the expectant mother should receive based upon her past immunization history. Information systems can integrate with clinical decision support using the Request for Clinical Guidance transaction.



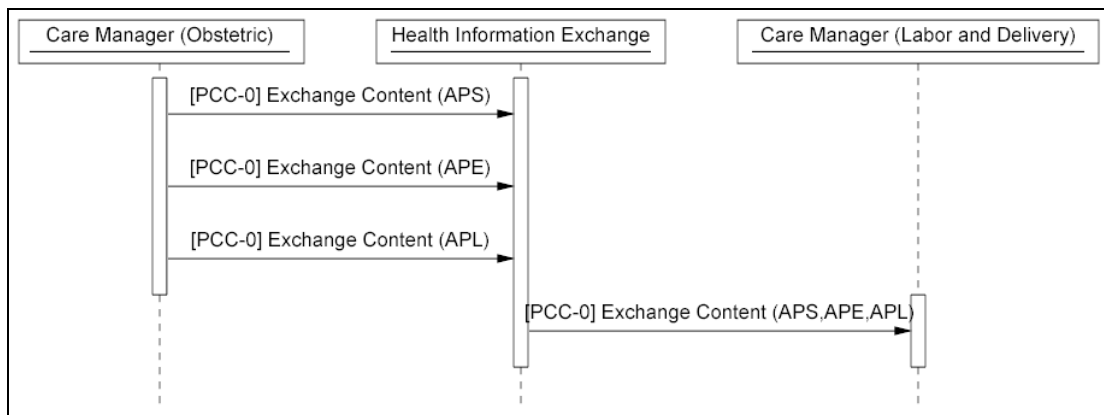
445 **Figure X.2.2.3-2 Clinical Decision Support Process Flow**

An ultrasound study may be ordered, and an updated date of delivery may be computed based on the results of that study. The images and results from this study can be shared for access by other providers, and also to the mothers PHR. An image enabled PHR can let the mother actually see the ultrasound results through her PHR.



**Figure X.2.2.3-3 Ultrasound Process Flow**

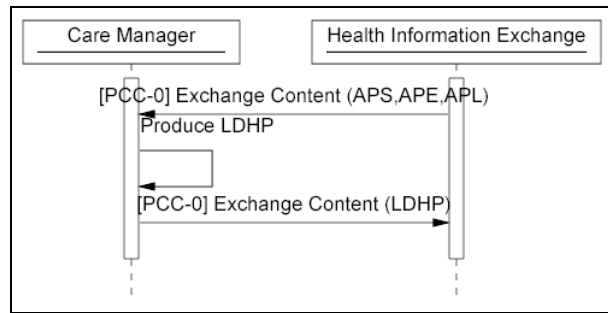
455 As the mother nears the date of delivery, the antepartum summary, the antepartum education, and lab results will be shared so that they may be accessed by the birthing center.



**Figure X.2.2.3-4 Predelivery Process Flow**

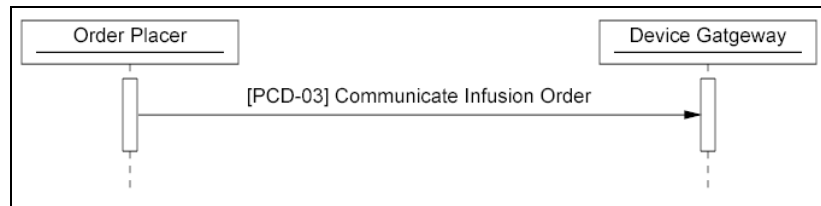
### X.2.2.4 Labor and Delivery

460 When the mother begins labor, she will be treated by the birthing center, which will access the prior documents as well as information from the mother’s PHR. A copy of the mothers most recent antepartum summary will be copied over to her labor and delivery records. Occasionally, another history and physical examination will be done at the time of admission.



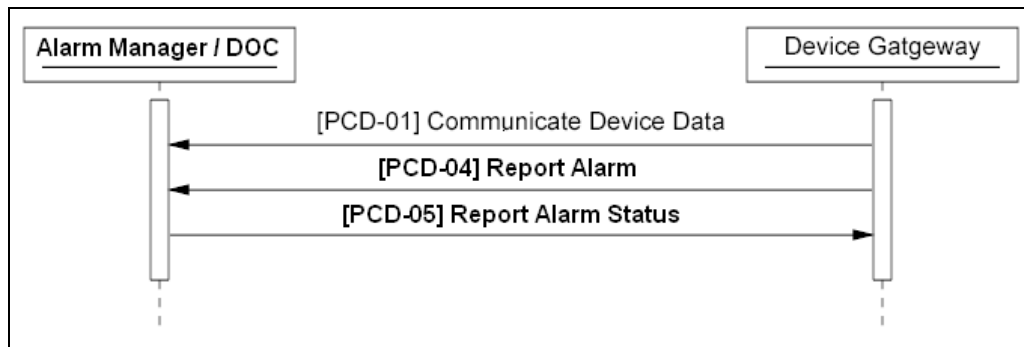
**Figure X.2.2.4-1 Labor and Delivery Admission H&P Process Flow**

465 As labor progresses, the mother may receive anesthesia through a programmable infusion pump. The order can be generated and transmitted to the pump by the order entry system for subsequent activation by the obstetric care provider.



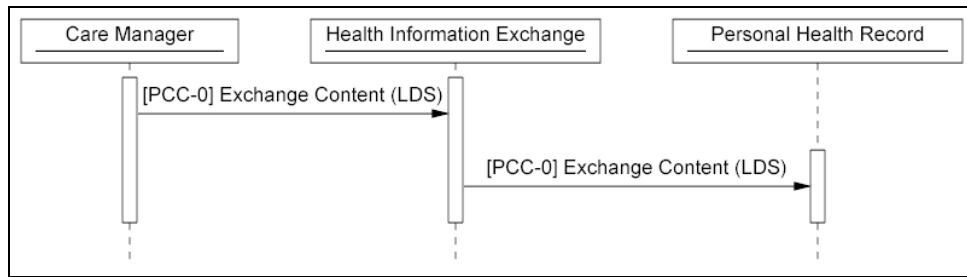
**Figure X.2.2.4-2 Anesthesia Process Flow**

470 The mother will be attached to monitors that will monitor both her and her unborn fetus(es). The monitoring data, and any alarms that might be generated, can be routed to the central monitoring station in the labor and delivery unit, or to pagers or other devices used to contact healthcare personnel at the labor and delivery facility.



475 **Figure X.2.2.4-3 Monitoring and Alarm Communication Process Flow**

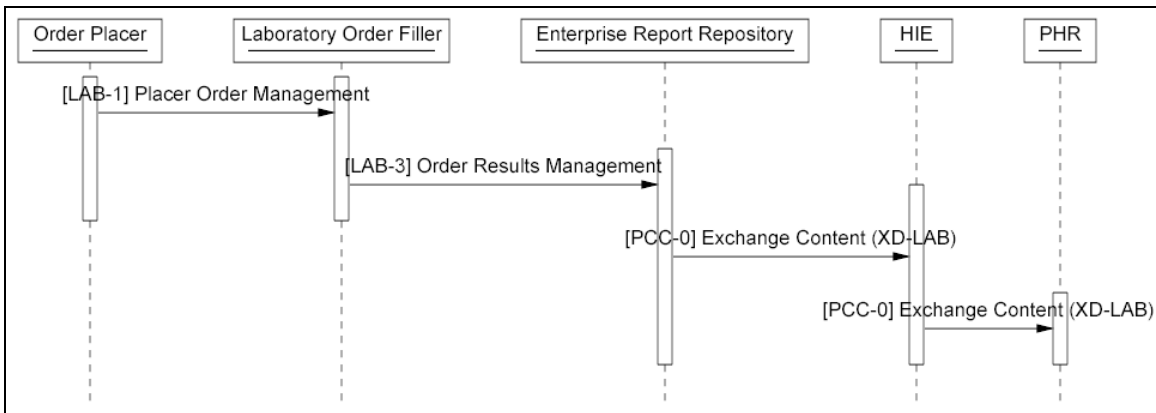
After successful delivery of the newborn, the labor and delivery summary is produced, and can be shared for subsequent access by the newborn’s pediatrician.



**Figure X.2.2.4-4 Labor and Delivery Summary Process Flow**

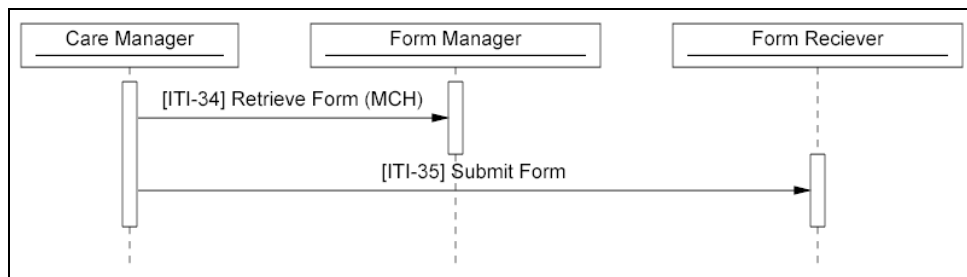
480 **X.2.2.5 After Delivery**

Per protocol, tests for the newborn hearing screening and a dried bloodspot test are ordered. The results of these tests are reported and placed in the newborn’s pediatric care folder.



**Figure X.2.2.5-1 Newborn Screening Process Flow**

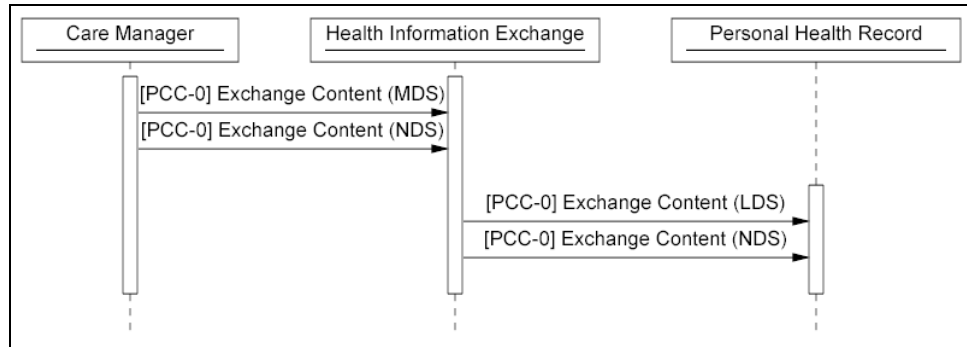
485 Information is communicated from the labor and delivery EHR to appropriate forms for submission of the birth certificate. When the mother is available (and has recovered) after delivery, she completes the necessary information not available from the EHR to obtain a birth certificate for her new baby (or babies). The form is submitted and a birth certificate is eventually mailed to the mother’s home.



490

**Figure X.2.2.5-2 Administrative Records Process Flow**

After a day or two, the mother and baby are discharged from the hospital. A discharge summary is produced for both of them. A copy of the mother’s discharge summary is made in the postpartum care folder, and the baby’s is placed in the newborn’s pediatric care folder.



495

**Figure X.2.2.5-3 Newborn and Mother Discharge Process Flow**

### X.2.2.6 Postpartum Care

500 After discharge, the mother follows up with her obstetric provider. Information from the delivery can be accessed by that provider through the health exchange. After the six-week, post partum visit, the mother’s obstetric provider completes the postpartum visit summary.

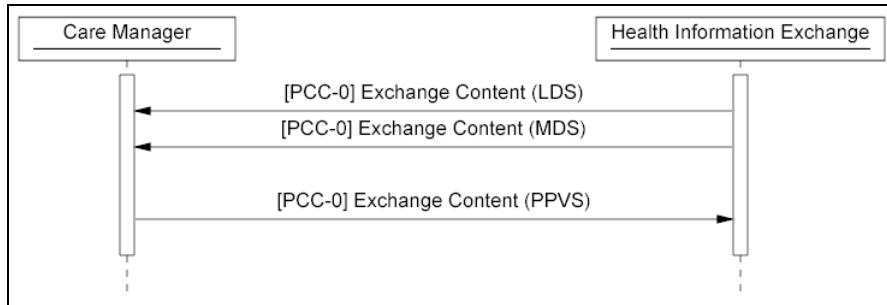
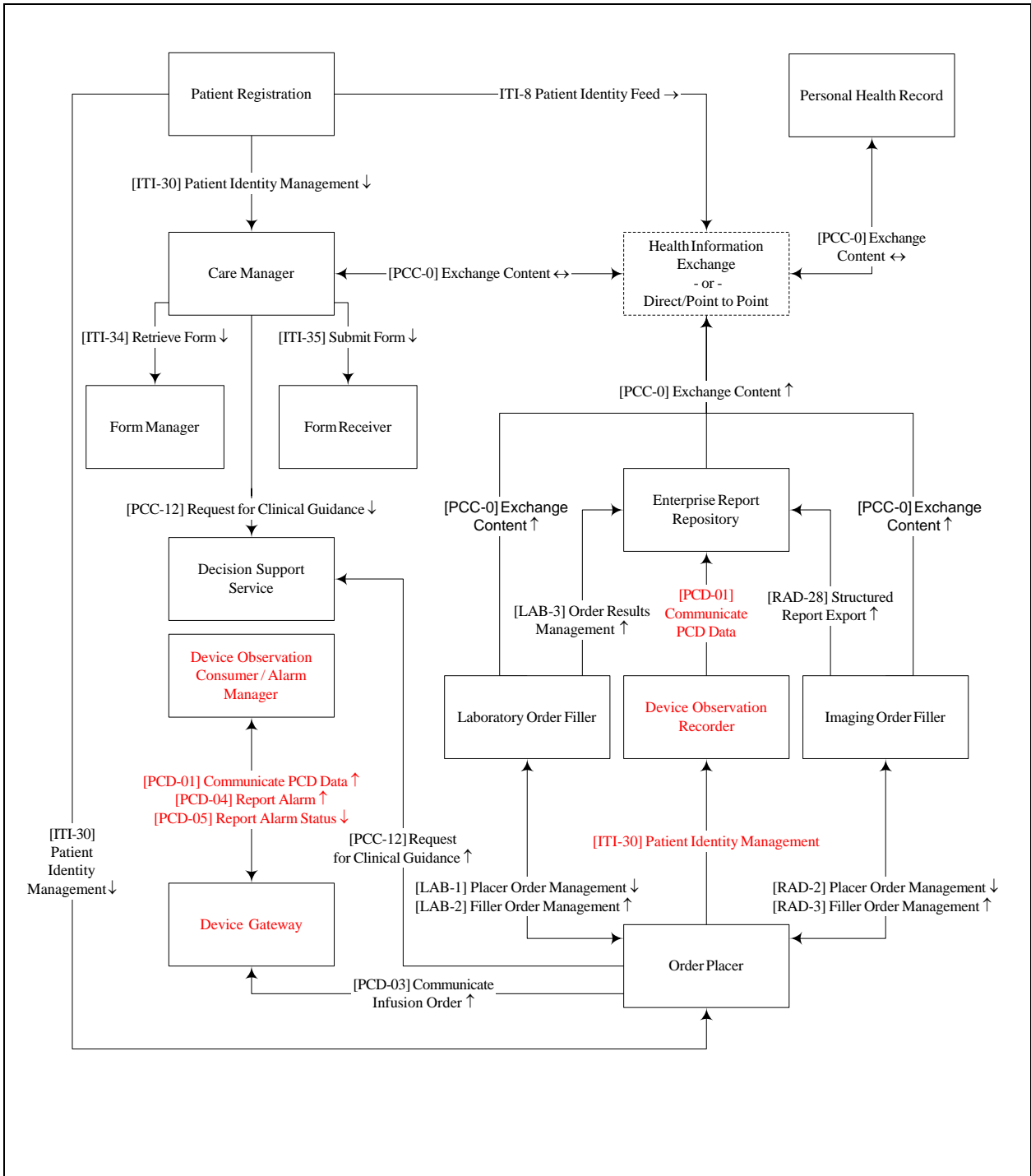


Figure X.2.2.6-1 Postpartum Process Flow

### X.3 Actors/ Transactions

505 There are 13 actors in this profile. Each actor represents a different information system or component of an information system. Figure X.3-1 shows the actors directly involved in the Perinatal Workflow (PW) Integration Profile and the relevant transactions between them. Other actors that may be indirectly involved due to their participation in other related profiles are not necessarily shown.



510

Figure X.3-1. Perinatal Workflow (PW) Actor Diagram



### **X.3.1 Patient Registration**

515 The Patient Registration Actor is responsible for communicating patient demographics and administrative data (e.g., insurance) to other actors in this profile. These other actors may choose to accept this information from the Patient Registration Actor, or may provide another mechanism to support registration. The actors that support the Patient Registration Option will accept this communication from the Patient Registration Actor. Actors that support this option  
520 must accept the information as specified in the ITI-30 Patient Administration Management transaction, IHE ITI TF-2:3.30.

### **X.3.2 Health Information Exchange**

The Health Information Exchange Actor is virtual in this profile. This actor represents the necessary components of a Health Information Exchange. When the PCC-0 Content Exchange  
525 transaction is performed using XDS actors, the Health Information Exchange represents an XDS Registry and Repository. When these exchanges are performed using the XDR or XDM profiles, the Health Information Exchange serves no purpose since the exchange occurs directly between the other actors of this profile using either point-to-point communications or media.

The Health Information Exchange accepts patient identity information using the ITI-8 Patient  
530 Identity Feed when XDS is used for the exchange. This is because the Health Information Exchange is only interested in a limited set of demographics used to uniquely identify the patient. It does not require additional information such as insurance or other administrative data.

### **X.3.3 Personal Health Record**

The Personal Health Record Actor represents the information system storing a mother's personal  
535 health data. This actor is responsible for supplying personal health data to the Care Manager actors through the PCC-0 Exchange Content transaction using the PHR Extract content specified in the Exchange of Personal Health Record Content profile.

### **X.3.4 Care Manager Actor**

The Care Manager Actor represents the component of the electronic health record that a  
540 healthcare provider interacts with. Its principal responsibility in this profile is to create the content appropriate to its setting and to share that information with other Care Manager actors in similar and other settings, and with the mother's PHR. The Care Manager has two options specific to the care setting, at least one of which must be implemented. A Care Manager implementing the Obstetric Option is intended to support obstetric care of the mother. A Care  
545 Manager implementing the Labor and Delivery Option is intended to support care of mother and newborn in a labor and delivery setting. Care Managers are required to produce the set of documents appropriate to the healthcare settings they support. All Care Managers must demonstrate the ability to access clinical documents from any setting. This is because more than one Obstetric setting or Labor and Delivery setting may be involved during the entire pregnancy,  
550 and providers at these settings may need to access documents produced in physically different settings serving the same function (obstetric care or labor and delivery). For example, while

traveling, a mother may experience premature labor. Her records of the successfully halted labor would still be needed at the labor and delivery setting where the final delivery of the newborn occurs.

555 The Care Manager implementing the Administrative Services option (e.g., Vital Records) also interacts as a Form Filler with the Form Manager and Form Receiver actors. It supports the gathering and submission of vital statistics to the appropriate authorities for issuance of appropriate birth documentation, or for referral to social services if needed.

### **X.3.5 Order Placer**

560 The Order Placer Actor represents the information system where the provider enters an order (e.g., CPOE). The Order Placer of this profile is composed of actors and transactions appearing in the IHE Radiology, Laboratory, and Patient Care Devices Technical Frameworks. The Order Placer of this profile implements all the ordering of specific transactions of the Structured Workflow (SWF) profile from the Radiology domain, the Laboratory Testing Workflow (LTW) profile from the Laboratory domain, and the Point of Care Infusion Verification (PIV) profile in the Patient Care Devices domain. Healthcare providers will need to order laboratory tests, and possibly imaging studies, during the care of the mother or newborn regardless of the healthcare setting.

570 Order Placers must be able to order tests from different locations. This profile requires that an Order Placer be able to order diagnostic tests from multiple locations. A typical obstetric setting may order lab tests from several laboratories depending upon the test, or several imaging centers depending upon the imaging study required.

### **X.3.6 Imaging Order Filler**

575 The Imaging Order Filler Actor represents the information system that receives and processes orders for imaging services. The Imaging Order Filler is a minor variation of Order Filler in the Structured Workflow (SWF) profile of the IHE Radiology Technical Framework. It supports the same ordering transactions as found in the SWF profile, but has one required and two optional transactions. From the perspective of the care providers in this profile, an Imaging Order Filler is a single information system that manages orders and results for a given type of study. To avoid unnecessary complexity, it is represented as a single actor in this profile even though the implementation may involve the coordination of several components on the Order Filler side.

580 The RAD-28 Structured Report Export transaction is used by the Imaging Order Filler to supply the report results to the Enterprise Report Repository. This transaction is the same one used by the Simple Image and Numeric Reporting (SINR) profile of the Radiology Technical Framework to supply imaging reports via an HL7 message.

590 The Imaging Order Filler implementing the Content Exchange option also supports the direct exchange of imaging reports via the PCC-0 Exchange Content transaction using the content specified in the XDS-SD profile. The Imaging Order Filler that implements the Imaging Data Exchange option supports direct exchange of imaging data and reports using the RAD-54 Provide and Register Imaging Document Set from the XDS-I profile.

### **X.3.7 Laboratory Order Filler**

The Laboratory Order Filler Actor represents the information system that receives and processes orders for laboratory testing. The Laboratory Order Filler is a simplification<sup>4</sup> of the Order Filler in the Laboratory Testing Workflow (LTW) profile of the IHE Laboratory Technical  
595 Framework. It supports the same ordering transactions as found in the LTW profile, but has one optional transaction. The Laboratory Order Filler implementing the Content Exchange option also supports the direct exchange of laboratory reports via the PCC-0 Exchange Content transaction using the content specified in XD-LAB profile.

### **X.3.8 Enterprise Report Repository**

600 The Enterprise Report Repository is able to share results with the Health Information Exchange by transforming them into the appropriate form (XD-LAB for laboratory results or XDS-SD for imaging results). This operation need not be automatic. It can be initiated by a user of the information system represented by the Enterprise Report Repository. It can also be performed  
605 automatically based on the business rules that are configured into that actor. For example, a laboratory result might be automatically shared if the patient has consented to sharing it, the provider has acknowledged its receipt, three days have elapsed since the report was acknowledged by the provider, and the report does not contain certain restricted results (e.g., HIV status). Enterprise Report Repositories that support rule based exporting must also provide a mechanism whereby providers can share a document based upon their professional judgement.

### **X.3.9 Device Observation Consumer / Alarm Manager**

610 The Device Observation Consumer / Alarm Manager Actor accepts monitoring and alarm data from the Device Gateway and makes it available to healthcare providers.

### **X.3.10 Device Gateway**

615 The Device Gateway Actor coordinates communication between the recording/viewing equipment and specialized monitoring (e.g., electronic fetal monitoring [EFM]) or treatment (e.g., Infusion Pump) devices.

### **X.3.11 Form Manager**

620 The Form Manager is used to retrieve forms that need to be completed for administrative purposes during the process of birth and delivery. Such forms may be used to submit data to obtain a birth certificate for the newborn child, or to support referrals of the mother and newborn for social services. The Care Manager sends clinical information about the birth to the forms manager using the Maternal Child Health content specified in the Maternal Child Health Profile. The Form Manager responds with the appropriate forms for these administrative services which can then be filled out by the Care Manager acting as the Forms Filler.

---

<sup>4</sup> A complete implementation of the Order Filler Actor from LTW meets all requirements of the Laboratory Order Filler Actor of this profile.

625 **X.3.12 Form Receiver**

Upon completion of these administrative forms, the Care Manager can submit them to the Form Receiver to initiate appropriate administrative actions, such as the submission of a birth certificate.

**X.3.13 Decision Support Service**

630 The Decision Support Service may be used by the Care Manager to identify appropriate education, testing, or treatment options for the mother or newborn.

**X.3.14 Device Observation Reporter**

635 The Device Observation Reporter communicates information from the Hearing Screening Device, and may accept information from the Order Placer to identify the newborn being screened.

640 All the actors described above, the transactions they must support, and the options for each actor are described in more detail in the table and sections following. Table X.3.14-1 lists the transactions for each actor directly involved in the Perinatal Workflow (PW) Profile. In order to claim support of this Integration Profile, an implementation must perform the required transactions for the profile and each of the options it supports.

645 In the following table the “Actors” column identifies the actors and their requirements in subsequent columns. The “Option” column identifies the defined options that requires a specific transaction or content from an IHE profile. This column will contain “All” if the requirements of the subsequent columns apply to any implementation of the actor. Otherwise it will identify the named option for which it applies.

650 The “Transactions/Content” column identifies the transactions or content that is supported by actors implementing the given option. The “Req” column indicates whether the transaction or content is required (labeled “R”) or is optional (labeled “O”). The last column provides a reference to the IHE publication and profile where the transaction was originally defined.

**Table X.3.14-1 Perinatal Workflow (PW) Integration Profile - Actors and Transactions**

Actors	Transactions	Req	Reference
Patient Registration	ITI-8 Patient Identity Feed	R	(PIX) ITI TF-2:3.8
	ITI-30 Patient Identity Management	R	(PAM) ITI TF-2:3.30
Personal Health Record	PCC-0 Exchange Content	R	(PW) PCC TF-2:3.0
Care Manager <sup>1</sup>	PCC-0 Exchange Content	R	(PW) PCC TF-2:3.0
Decision Support Service	PCC-12 Request for Clinical Guidance	R	(RGC) PCC TF-2:3.12

Actors	Transactions	Req	Reference
Order Placer	RAD-2 Placer Order Management	R	(SWF) RAD TF-2:4.2
	RAD-3 Filler Order Management	R	(SWF) RAD TF-2:4.3
	LAB-1 Placer Order Management	R	(LTW) LAB TF-2:4.1
	LAB-2 Filler Order Management	R	(LTW) LAB TF-2:4.2
	ITI-30 Patient Identity Management (as Patient Demographics Consumer)	C <sup>2</sup>	(PAM) ITI TF-2:3.30
	PCD-03 Communicate Infusion Order	C <sup>5</sup>	(PIV) PCD PIV
	PCC-12 Request for Clinical Guidance	C <sup>3</sup>	(RCG) PCC TF-2:3.12
	ITI-30 Patient Identity Management (as Patient Demographics Supplier)	C <sup>6</sup>	(PAM) ITI TF-2:3.30
Imaging Order Filler	RAD-2 Placer Order Management	R	(SWF) RAD TF-2:4.2
	RAD-3 Filler Order Management	R	(SWF) RAD TF-2:4.3
	RAD-28 Structured Report Export	R	(SINR) RAD TF-2:4.28
	RAD-54 Provide and Register Imaging Document Set	C <sup>9</sup>	(XDS-1) RAD TF-3:4.54
	PCC-0 Exchange Content	C <sup>8</sup>	(PW) PCC TF-2:3.0
Laboratory Order Filler	LAB-1 Placer Order Management	R	(LTW) LAB TF-2:4.1
	LAB-2 Filler Order Management	R	(LTW) LAB TF-2:4.2
	LAB-3 Order Results Management	R	(LTW) LAB TF-2:4.3
	PCC-0 Exchange Content	C <sup>8</sup>	(PW) PCC TF-2:3.0
Device Observation Reporter	PCD-01 Communicate PCD Data	R	(DEC) PCD TF-2:3.1
	ITI-30 Patient Identity Management	O	(PAM) ITI TF-2:3.30
Enterprise Report Repository	RAD-28 Structured Report Export	R	(SWF) RAD TF-2:4.28
	LAB-3 Order Results Management	R	(LTW) LAB TF-2:4.3
	PCC-0 Exchange Content	R	(PW) PCC TF-2:3.0
	PCD-01 Communicate Device Data	C <sup>6</sup>	(DEC) PCD TF-2:3.1
Device Observation Consumer / Alarm Manager	PCD-01 Communicate Device Data	R	(DEC) PCD TF-2:3.1
	PCD-04 Report Alarm	R	(ACM) PCD ACM
	PCD-05 Report Alarm Status	R	(ACM) PCD ACM
Device Gateway	PCD-01 Communicate Device Data	R	(DEC) PCD TF-2:3.1
	PCD-03 Communicate Infusion Order	R	(PIV) PCD PIV
	PCD-04 Report Alarm	R	(ACM) PCD ACM
	PCD-05 Report Alarm Status	R	(ACM) PCD ACM
Form Manager	ITI-34 Retrieve Form	R	(RFD) ITI RFD-2:3.34
Form Receiver	ITI-35 Submit Form	R	(RFD) ITI RFD-2:3.35

Note 1: The Care Manager must support the View Option of Content Consumer for all content profiles listed.

Note 2: Required if the Patient Registration Management option is supported.

Note 3: Required if the Clinical Decision Support option is supported.

Note 4: Required if the Obstetrics option is supported.

Note 5: Required if the Labor and Delivery option is supported.

Note 6: Required if the Newborn Care option is supported.

Note 7: Required if the Administrative Services option is supported.

Note 8: Required if the Content Creator Option is supported.

Note 9: Required if the Imaging Data Option is supported.

655

660

**Table X.3.14-2 Perinatal Workflow (PW) Integration Profile - Actors and Content Requirements**

665

Actors	Content	Req	Reference
Patient Registration	None		
Personal Health Record	PHR Extract	R	(XPHR) PCC TF-2:6.3.1.5
	MDS Maternal Discharge Summary (as Consumer)	R	(APR) PCC APR:C
	NDS Newborn Discharge Summary (as Consumer)	R	(NDS) PCC NDS
	LDS Labor and Delivery Summary (as Consumer)	R	
Care Manager <sup>1</sup>	PHR Extract	R	(XPHR) PCC TF-2:6.3.1.5
	XDS-SD Scanned Documents	O	(XDS-SD) ITI TF-3:5.2
	XD-LAB Sharing Laboratory Reports	O	(XD-LAB) LAB TF-3:2
	APS Antepartum Summary	C <sup>4</sup>	(APR) PCC APR:W
	APHP Antepartum H & P	C <sup>4</sup>	(APR) PCC APR:X
	APE Antepartum Education	O	(APR) PCC APR:Y
	APL Antepartum Laboratory	O	(APR) PCC APR:Z
	PPVS Post Partum Visit Summary	C <sup>4</sup>	(PPVS) PCC PPVS
	LDHP Labory and Delivery History and Physical	C <sup>5</sup>	(LDR) PCC LDR:A
	LDS Labor and Delivery Summary	C <sup>5</sup>	(LDR) PCC LDR:B
	MDS Maternal Discharge Summary	C <sup>5</sup>	(LDR) PCC LDR:C
	NDS Newborn Discharge Summary	C <sup>6</sup>	(NDS) PCC NDS
	MCH Maternal Child Health (Vital Records)	C <sup>7</sup>	(MCH) QRPH MCH
	Decision Support Service	None	
Order Placer	None		
Imaging Order Filler	XDS-SD Scanned Documents	C <sup>8</sup>	(XDS-SD) ITI TF-3:5.2
Laboratory Order Filler	XD-LAB Sharing Laboratory Reports	C <sup>8</sup>	(XD-LAB) LAB TF-3:2
	Newborn Bloodspot Test	C <sup>6</sup>	<i>TBD</i>
Device Observation Reporter	None		
Enterprise Report Repository	XD-LAB Sharing Laboratory Reports	R	(XD-LAB) LAB TF-3:2
	XDS-SD Scanned Documents	R	(XDS-SD) ITI TF-3:5.2
Device Observation Consumer / Alarm Manager	None		
Device Gateway	None		
Form Manager	MCH Maternal Child Health	R	(MCH) QRPH MCH
Form Receiver	None		

Note 1: The Care Manager must support the View Option of Content Consumer for all content profiles listed.

Note 2: Required if the Patient Registration Management option is supported.

Note 3: Required if the Clinical Decision Support option is supported.

Note 4: Required if the Obstetrics option is supported.

Note 5: Required if the Labor and Delivery option is supported.

Note 6: Required if the Newborn Care option is supported.

Note 7: Required if the Administrative Services option is supported.

670

Note 8: Required if the Content Creator Option is supported.

Note 9: Required if the Imaging Data Option is supported.

675

## X.4 Perinatal Workflow (PW) Integration Profile Options

Options that may be selected for this Integration Profile are listed in table X.4-1 along with the Actors to which they apply. Dependencies between options, when applicable, are specified in notes.

680

**Table X.4-1 Perinatal Workflow (PW) - Actors and Options**

Actor	Options	Vol & Section
Patient Registration	<i>No options defined</i>	--
Personal Health Record	<i>No options defined</i>	--
Care Manager	<i>Patient Registration Option</i>	X.4.1
	<i>Obstetrics Option<sup>1</sup></i>	X.4.2
	<i>Labor and Delivery Option<sup>1</sup></i>	X.4.3
	<i>Newborn Care Option<sup>1</sup></i>	X.4.4
	<i>Clinical Decision Support Option</i>	X.4.8
	<i>Administrative Services Option</i>	X.4.7
Decision Support Service	<i>No options defined</i>	--
Order Placer	<i>Patient Registration Option</i>	X.4.1
	<i>Newborn Care Option</i>	X.4.4
Imaging Order Filler	<i>Content Creator Option</i>	X.4.5
	<i>Imaging Data Option</i>	X.4.6
Laboratory Order Filler	<i>Content Creator Option</i>	X.4.5
Enterprise Report Repository	<i>Newborn Care Option</i>	X.4.4
Device Observation Consumer/Alarm Manager	<i>No options defined</i>	--
Device Observation Reporter		
Device Gateway	<i>No options defined</i>	--
Form Manager	<i>No options defined</i>	--
Form Receiver	<i>No options defined</i>	--

Note 1: At least one of these options shall be specified.

#### **X.4.1 Patient Registration Option**

685 An actor implementing the Patient Registration option must implement transaction ITI-30 Patient Identity Management. A system that passes the tests for the Patient Demographics Consumer as described in the IHE ITI Patient Administration Management (PAM) profile has successfully demonstrated implementation of this option.

#### **X.4.2 Obstetrics Option**

690 A Care Manager that implements the Obstetrics Option is intended for use in that setting and is capable of creating the necessary content that is shared from an outpatient obstetric setting (office) to a labor and delivery setting. A system that passes tests for the Content Creator actors defined for the Antepartum Summary (APS) and Antepartum History and Physical (APHP) content profiles has successfully demonstrated implementation of this option.

#### **X.4.3 Labor and Delivery Option**

Actors that implement the Labor and Delivery Option are intended for use in that setting.

695 The Care Manager must also be capable of creating the necessary content that is shared from a labor and delivery setting to other providers. A Care Manager system that passes tests for the Content Creator actors defined for the Labor and Delivery History and Physical (LDHP), Labor and Delivery Summary (LDS), and Maternal Discharge Summary (MDS) has successfully demonstrated implementation of this option.

700 Order Placer actors must demonstrate the ability to place orders to control an infusion pump, and so is required to implement the PCD-03 Communicate Infusion Order transaction from the Point of Care Infusion Verification (PIV) profile.

#### **X.4.4 Newborn Care Option**

705 Actors that implement the Newborn Care Option are intended for use in settings that provide care for newborns.

Care Manager actors implementing this option support the creation of the Newborn Discharge Summary (NDS) specified in profile supplements issued this year. A system that passes tests for the Content Creator actors defined for these profiles has demonstrated implementation of this option.

710 Order Placer actors that support the newborn care option must implement the Patient Demographics Supplier actor of the Patient Administration Management Profile to ensure that patient identification information can be transmitted to hearing screening equipment.

Laboratory Order Fillers that implement this option must implement the Content Creator actor of the Newborn Bloodspot Test results in the LAB-3 Order Results Management message in response to orders for those tests.

715

Note: Please provide feedback on the use of the LTW profile to order a newborn hearing screening. Although the LTW use case is specifically for laboratory orders, it seems as if it could be used to order other non-laboratory diagnostic tests.



720 Enterprise Report Repositories that implement this option must act as a Device Observation Consumer to receive results from a hearing screening device acting as a Device Observation Reporter using the PCD-01 Communicate PCD Data transaction.

#### **X.4.5 Content Creator Option**

An Order Filler implementing the Content Creator option demonstrates that it can exchange the result of that order with other systems (e.g., through a Health Information Exchange).

725 A Laboratory Order Filler must share results (implement the Content Creator actor) using the XD-LAB Sharing Laboratory Results profile. An Imaging Order Filler must share results (implement the Content Creator actor) using the XDS-SD Scanned Documents profile

#### **X.4.6 Imaging Data Option**

730 An Imaging Order Filler that implements the Imaging Data Option is required to implement transaction RAD-54 Provide and Register Imaging Document Set as described in the XDS-I profile. Actors supporting this option are able to support the exchange of images (e.g., ultrasounds).

#### **X.4.7 Administrative Services Option**

735 A Care Manager that implements the Vital Records option is able to submit vital records data to a vital records registry through the use of the ITI Request Form for Data Capture (RFD) profile and the QRPH Maternal Child Health (MCH) profile.

#### **X.4.8 Clinical Decision Support**

740 Actors that implement the Clinical Decision Support option are able to issue a PCC-12 Request for Clinical Guidance transaction prior to completing another transaction specified in this profile to ensure that appropriate care is being given. The Perinatal Workflow profile does not provide specific content guidelines on the types of clinical decision support that could be provided.

### **X.5 Perinatal Workflow (PW) Security Considerations**

745 The Perinatal Workflow profile incorporates transactions and actors from previously existing IHE profiles. Security considerations appropriate to those actors and transactions are also relevant in this profile, as are some new considerations that arise from the combination of these actors and transactions.

#### **X.5.1 Misidentified Patient**

750 During patient registration, a patient may be misidentified as a result of insufficient differentiating demographics. This risk is present in any system that has a registration function and is not specific to this profile. It is potentially present in any system that uses the Patient Identity Cross Referencing (PIX), Patient Demographics Query (PDQ), or Patient Administration Management (PAM) profiles.

755 Patient misidentification can result in comingling of administrative and medical data for two patients. This may result in the loss of integrity of the health information for both patients, and could result in the use of inappropriate treatments for one or both patients. The transactions used in this profile for patient identity management support the inclusion of additional demographics which can be used to confirm the identity of a patient. Systems implementing this profile should ensure that appropriate details are incorporated into transactions communicating patient identity (e.g., addresses and other identifiers).

#### 760 **X.5.2 Malicious attempts to obtain patient information**

Malicious attackers or users may attempt to gain patient identity information to perpetrate fraud (e.g., identity theft, insurance theft), or to obtain health information for other purposes (e.g., report a pregnancy of a well-known individual).

765 This is a general threat to any application which contains healthcare information and is not specific to this profile.

To protect the information, the users of the applications providing access to it should be able to authenticate themselves to the application. When information is exchanged electronically, the communications channel should either be physically secured, encrypted, or both. Finally, any access to patient health data should be audited. Actors of this profile can be grouped with the  
770 IHE Enterprise User Authentication (EUA) profile to establish their credentials. They can also be grouped with the IHE ATNA profile to ensure that communications are encrypted, and access to patient health information is audited.

#### **X.5.3 Accidental Release of Protected Health Information**

775 Certain kinds of health information is often recognized by law or regulation as being more sensitive and requiring additional protection before exchange or disclosure. For example, psychiatric records, or participation in alcohol or substance abuse programs are protected by state and federal law in the US.

This is a general threat to any application which contains sensitive healthcare information and is not specific to this profile.

780 Applications implementing this profile must ensure that appropriate access controls and permissions are applied to users. IHE Enterprise User Authentication (EUA) profile can be used to establish user credentials within an enterprise, or the Cross Enterprise User Authentication (XUA) profile can be used to communicate user information across enterprises. Data requiring an additional level of protection can be identified as has been specified in the IHE Basic Patient  
785 Privacy Consents (BPPC) profile.

#### **X.5.4 Inability to Communicate Orders due to System Failure or Malicious Attack**

790 The Order Placer in this profile may not be able to communicate orders to a receiving system. The failure of this communication will become obvious to providers, and fallback mechanisms can be used to ensure orders are executed. Typical communication failures will be immediately obvious through application behaviors. Failures due to malicious attack would not be

795 immediately obvious but would eventually be detected by lack of response to the order, and would be more rare. Orders described by this profile are for diagnostic tests rather than therapeutic treatments, which reduces risk somewhat that the failure to communicate the order would result in loss of life or quality of life issues. Implementors of this profile should ensure that appropriate responses to orders are monitored.

### **X.5.5 Inappropriate Communication of Mother / Child Identity in Adoption Cases**

800 In cases of pregnancy where the child is subsequently placed for adoption by the mother, information about the mother or the child may be inappropriately communicated to the other through exchange of medical documents describing results affecting both patients (e.g., the labor and delivery summary). Applications implementing this profile should provide a mechanism to disable communication of the mother's data to the child's record and visa versa, or anonymize that data. Anonymization of the mother's and/or child's record is out of scope for this profile, but may be the subject of future work in the PCC or ITI domain.

### **X.5.6 Externally sourced data may be inaccurate or unreliable**

805 One concern often expressed about the exchange of information between patients and providers, or even between two providers is that data coming from outside the organization may be inaccurate or unreliable. Because there are multiple data sources from which information can be gathered, there will rarely be a single source for a relevant piece of health information. The availability of multiple sources for health information enables providers a cross check for certain health information. In cases where there is a new finding, the provider would simply use the same mechanisms to verify the information as they would if it came to them through non-electronic means (as they already do today).

815 Information that comes from external sources through the XDS, XDM or XDR profiles uses a message authentication code, so that providers can be assured that it has not been altered in transit. Furthermore, this information can also be digitally signed by the information source using the IHE Digital Signature profile (DSG). This assures the receiver of the information that it cannot be repudiated by the signer of the data. This does not address the reliability of the information source itself. Providers must use existing methods to verify information they receive from external sources (e.g., as are used with patient communicated histories, or paper copies of medical records).

## **X.7 Content Modules**

### **X.7.1 Antepartum Folder**

825 The Antepartum Folder is intended to contain documents that contain the record of antepartum care including initial patient history and physical, recurring evaluations of mother and fetus(es), laboratory studies, patient education, and on-going plans of care. The following PCC content profiles may appear in the Antepartum Folder:

1. Antepartum History & Physical (APHP) – The initial assessment, patient histories and physical examination
2. Antepartum Summary (APS) – Aggregation of significant events, diagnoses and plans of care derived from the visits over the course of an antepartum episode
3. Antepartum Laboratory (APL) – Laboratory evaluations pertinent to the antepartum episode
4. Antepartum Education (APE) – Education provided during the antepartum episode

A sample form showing the data elements for the content listed above may be found at:

<http://www.acog.org/bookstorefiles/aa128.pdf>.

### **X.7.2 Labor and Delivery Folder**

The Labor and Delivery Folder provides comprehensive information regarding the course of labor and delivery to healthcare providers caring for both the mother and the newborn in the postpartum period. For example, in cases such as chorioamnionitis or birth trauma, if the postpartum nurse or the attending obstetrician were not present at the birth, the LDR would be crucial for risk identification and appropriate inpatient postpartum care. The pediatrician uses the information present in the LDR to develop the infant’s plan of care.

In some settings, public health officials are interested in the labor, delivery and inpatient postpartum information as to better monitor the mother and child’s health, and develop quality improvement processes if necessary. Certain data present in the Labor and Delivery Folder may be monitored anonymously as to conduct studies about population health.

## Glossary

*Add the following terms to the Glossary:*

- 850 **Anesthesia**  
Loss of the ability to feel pain, caused by administration of a drug or other medical intervention.
- Antepartum**  
Of or occurring in the period before childbirth
- 855 **Antibody screen**  
A blood test to detect antibodies against red blood cell antigens.
- Apgar scores**
- 860 A score that assesses the general physical condition of a newborn infant by assigning a value of 0, 1, or 2 to each of five criteria: heart rate, respiratory effort, muscle tone, skin color, and response to stimuli. The five scores are added together, with a perfect score being 10.
- Blood type**
- 865 Test to determine blood group, i.e., A, B, AB or O
- Certified Nurse Midwife**  
A nurse with specialized education and training in providing care to childbearing women during all stages of pregnancy including the postpartum period.
- 870 **Contraception (birth control)**  
A process that prevents pregnancy by interfering with the normal process of ovulation, fertilization, and implantation. There are different kinds of birth control that act at different points in the process.
- 875 **Contractions**  
Obstetric volleys of tightening and shortening of the myometrium (uterine muscle), which occur during labor, cause dilatation and thinning of the cervix and aid in the descent of the infant in the birth canal.
- 880 **Delivery**  
Expulsion or extraction of the infant, placenta and membranes at birth.
- D(Rh) Antibody Screen**
- 885 A blood screening test for presence of IgG antibodies to the Rh D antigen on red blood cells.
- D (Rh) Sensitized**

890 Rh negative mother is sensitized to the Rh D antigen. A sensitized mother produces IgG anti-D (antibody) that crosses the placenta and coats D-positive fetal red cells which are then destroyed in the fetal spleen.

**Erythrocytes**

A red blood cell that transports oxygen through the body.

895 **Gestation**

The period of development in the uterus from conception until birth; pregnancy.

**Hematocrit**

900 The volume percentage of erythrocytes in whole blood.

**Hepatitis B**

A serious liver infection caused by the hepatitis B virus (HBV). Pregnant women who are infected with hepatitis B can transmit the virus to their newborns during pregnancy or delivery.

905 **Incision**

A cut into a body tissue or organ, especially one made during surgery or the scar resulting from such a cut.

**Inpatient**

910 A patient who is admitted to a hospital or clinic for treatment that requires at least one overnight stay.

**Labor**

915 The function of the female by which the infant is expelled through the vagina to the outside world: the first stage begins with onset of regular uterine contractions and ends when the os is completely dilated and flush with the vagina; the second extends from the end of the first stage until the expulsion of the infant is completed; the third extends from expulsion of the infant until the placenta and membranes are expelled; the fourth denotes the hour or two after delivery, when uterine tone is established.

920

**Multiparous**

Having given birth to more than one offspring.

**Multiple Gestation or Multiple Birth**

925 A multiple gestation or multiple birth occurs when more than one fetus is carried to term in a single pregnancy.

**Myometrium**

The muscular wall of the uterus.

930

**Neonatal**

Pertaining to a newborn child < 28 days of age or 44 weeks postconceptual age.

**NICU**

935 Neonatal intensive-care unit. Unit of a hospital specializing in the care of ill or premature newborn infants.

**Obstetrician**

940 A physician whose practice of medicine focuses on the care of women during pregnancy, through childbirth, and immediately following delivery. Often informally known as ob-gyn (obstetrician-gynecologist).

**Outpatient**

945 A patient not hospitalized >24 hours or housed in an extended care facility, who is being treated in an office, clinic, or other ambulatory care facility.

**Pediatrician**

950 A specialist in pediatrics. Pediatrics is the branch of medicine that deals with the development and care of infants and children and the treatment of their diseases.

**Postpartum**

Of or occurring in the period shortly after childbirth.

**RPR (Rapid Plasma Reagin)**

955 Rapid Plasma Reagin (RPR) refers to a type of test that looks for non-specific antibodies in the blood of the patient that may indicate that the organism (*Treponema pallidum*) that causes syphilis is present.

**Sepsis**

960 Sepsis refers to a bacterial infection in the bloodstream or body tissues. In the use case, the newborn sepsis is a severe systemic infection of the newborn.

**Streptococcus B**

965 Group B streptococcus (group B strep) is a bacterium that causes life-threatening infections in newborn infants. Group B strep can also cause serious diseases in pregnant women, the elderly, and adults with other illnesses. The letter "B" refers to a classification of bacteria in the genus *Streptococcus* according to the makeup of the organism's cell wall.

**VDRL (Venereal Disease Research Laboratories)**

970 A blood test to screen for the presence of antibodies against *Treponema pallidum*, the bacteria that causes syphilis.

## Volume 2 - Transactions

*Add Section 3.Y*

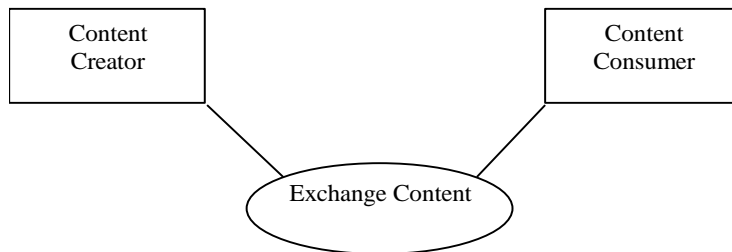


### 3.0 Exchange Content

975 This section corresponds to Transaction 0 of the IHE PCC Technical Framework. Transaction 0 is used by the Content Creator and Content Consumer actors of various IHE Content profiles.

#### 3.0.1 Scope

#### 3.0.2 Use Case Roles



980

**Actor:** Content Creator

**Role:** Create Content

**Actor:** Content Consumer

**Role:** View or Import Content

#### 985 3.0.3 Referenced Standard

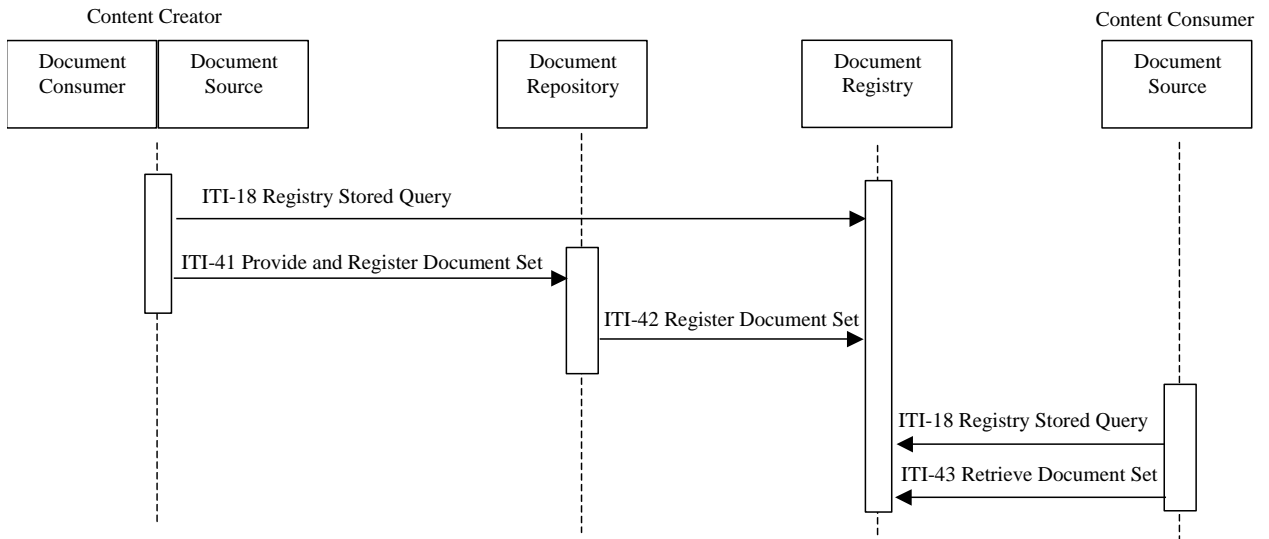
IHE XDS, XDR or XDM profiles of ebXML RIM and Registry Services.

#### 3.0.4 Interaction Diagram

Interactions for the PCC 0 Exchange Content transaction vary depending upon the infrastructure used for the health information exchange.

#### 990 3.0.4.1 Exchange Content with Cross Enterprise Document Sharing

See IHE Cross Enterprise Document Sharing (XDS) in ITI TF-1: 10 and the related transactions in ITI TF-2a:18 and ITI TF-2b:41 and 42. The sequence of operations is as shown in Figure 3.0-1 below



995

**Figure 3.0-1 XDS Actors and Transactions for Exchange Content**

**3.0.4.1.1 ITI-18 Registry Stored Query**

1000 This interaction is optional in most cases. It may be required when a specific folder must be used in an exchange operation, and that folder must be discovered.

**3.0.4.1.2 ITI-41 Provide and Register Document Set**

1005 The Provide and Register Document set interaction is required to communicate the contents of the exchange to the document repository. The repository is then required to communicate the registration information to the document registry for subsequent (asynchronous) retrieval by the content consumer.

**3.0.4.1.3 ITI-18 Registry Stored Query**

This interaction is used by the content consumer to locate the documents that have been submitted.

**3.0.4.1.4 ITI-43 Retrieve Document Set**

1010 This interaction is used by the content consumer to retrieve the documents that have been submitted.

### 3.0.4.2 Exchange Content with Cross Enterprise Document Reliable Interchange

1015 See IHE Cross Enterprise Document Reliable Exchange (XDR) and the related transactions in ITI TF-2b:41. The sequence of operations is as shown in Figure 3.0-2 below

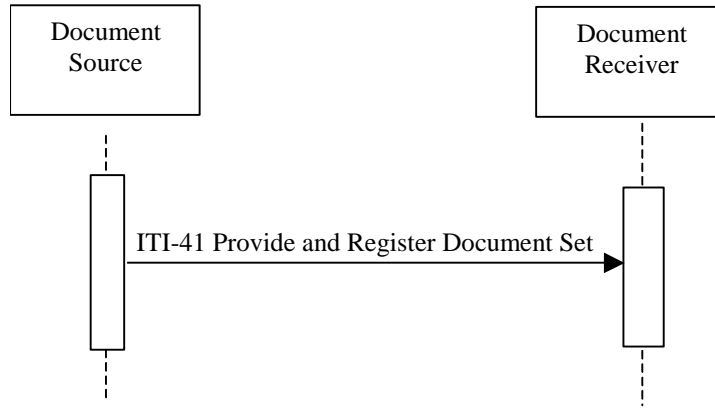


Figure 3.0-2 XDR Actors and Transactions for Exchange Content

#### 3.0.4.2.1 ITI-41 Provide and Register Document Set

1020 The Provide and Register Document set interaction is required to communicate the contents of the exchange to the document receiver. There is no mechanism to query for appropriate folders to place documents in when using the Provide and Register Document Set.

### 3.0.4.3 Exchange Content with Cross Enterprise Document Sharing on Media

1025 See IHE Cross Enterprise Document Sharing on Media (XDM) and the related transaction in ITI TF-2b:32. The sequence of operations is as shown in Figure 3.0-3 below

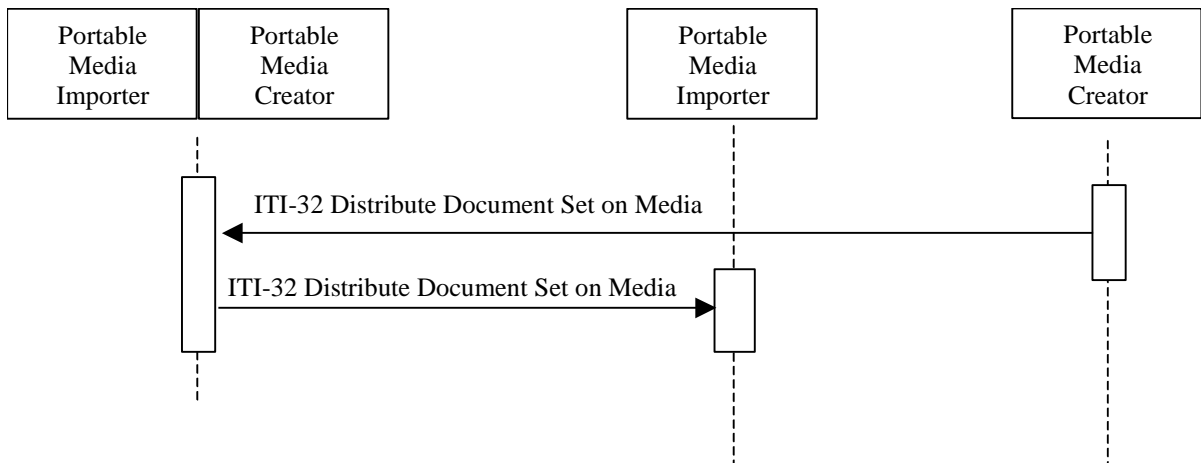


Figure 3.0-3 XDM Actors and Transactions for Exchange Content

### 3.0.4.3.1 ITI-32 Distributed Document Set on Media

1030 The location of folders to use on the media can be determined by looking at existing media.

### 3.0.5 Security Considerations

Content Creator Actors are responsible for ensuring that only authorized users create content, that the author of this content is identified within the documents exchanged, and that communications are secured between the sender and receiver.

1035 Content Consumer Actors are responsible for ensuring that only authorized users obtain access to content that is being retrieved and/or imported into the receiving system, and that communications are secured between it and the sender.

#### 3.0.5.1 Security Audit Considerations

1040 Appropriate audit messages must be generated according to the specifications for the transactions used from the ITI Technical Framework.

*Insert Section 6.2 below*

## 6.2 Folder Specifications

1045 Folders can be used for many purposes in information exchanges that support the XDS, XDR and XDM profiles. One such use is to gather information together for a single episode of care, where that episode has a defined starting and ending point. Folders that are used for this purpose are created based on a given trigger event that signals the start of an episode of care. Often this will be the creation of a particular kind of document that signals the new episode. Because it is hard to automate the determination of episode of care, applications using folders for this purpose should provide a mechanism to allow users to validate the folder where documents are being

1050 created. Figure 6.2-1 below shows an example of the metadata used with a Folder being used for this purpose.

```

1055 <RegistryPackage id="Folder">
  <Name>
    <LocalizedString value="Labor and Delivery Records"/>
  </Name>
  <Description>
    <LocalizedString value="comments"/>
  </Description>
1060 <!-- Classify registry package Folder as being an XDSFolder -->
  <Classification
    classificationNode="urn:uuid:d9d542f3-6cc4-48b6-8870-ea235fbc94c2"
    classifiedObject="Folder"/>
  <!-- Classify this Folder as being a collection of labor and delivery records -->
1065 <Classification
    classificationScheme="urn:uuid:1ba97051-7806-41a8-a48b-8fce7af683c5"
    classifiedObject="Folder" nodeRepresentation="15508-5">
  <Name>
    <LocalizedString value="Labor and Delivery Records"/>
  </Name>
1070 <Slot name="codingScheme">
  <ValueList>

```

```

1075   <Value>LOINC</Value>
        </ValueList>
        </Slot>
        </Classification>
        <!-- Patient Identifier -->
        <ExternalIdentifier
1080   identificationScheme="urn:uuid:f64ffdf0-4b97-4e06-b79f-a52b38ec2f8a"
        value="6578946^^^&1.3.6.1.4.1.21367.2005.3.7&ISO">
        <Name>
        <LocalizedString value="XDSFolder.patientId"/>
        </Name>
        </ExternalIdentifier>
1085   <!-- Folder Identifier -->
        <ExternalIdentifier
        identificationScheme="urn:uuid:75df8f67-9973-4fbe-a900-df66cefecc5a"
        value="1.3.6.1.4.1.21367.2005.3.7.3670984664">
        <Name>
1090   <LocalizedString value="XDSFolder.uniqueId"/>
        </Name>
        </ExternalIdentifier>
        </RegistryPackage>

```

Figure 6.2-1 Folder Metadata Example

## 1095 6.2.A Antepartum Folder Specification

The Antepartum Folder contains information from the Antepartum Care period of a pregnancy.

1100 This folder should be coded as required for the Region where it is used. A recommended code to use is 57082-0 Antepartum Records from LOINC. The Antepartum Folder contains a set of documents describing care given during the Antepartum period of a pregnancy. This period is defined as the period between determination of pregnancy and the beginning of the final labor of the pregnancy.

1105 Under exceptional conditions a pregnancy can have multiple periods of labor and delivery which may also overlap the antepartum period. For example, a premature labor may occur which is successfully stopped. In these cases, a Labor and Delivery folder is created for each distinct Labor and Delivery period (see Labor and Delivery Folder below).

1110 The Antepartum Folder is expected to contain documents conforming to the content specifications for the Antepartum History and Physical (APHP), Antepartum Education (APE), Antepartum Labs (APL) and Antepartum Summary (APS). In addition, it may contain other documents such as imaging studies (XDS-I), laboratory results (XD-LAB), or other content pertinent to the antepartum care of the patient.

When an APHP, APE, APL or APS document is shared, the Content Creator shall:

1. Determine the appropriate Antepartum Folder to use for sharing
- or
2. Create an Antepartum Folder if an appropriate one does not already exist.

1115 The first step is completed by:

1. Locating the most recently updated (XDSFolder.lastUpdate) Antepartum Folder for the patient (either on existing XDM media being updated, or in an XDS registry).

- 1120 2. Verifying that this folder is correct. The reason for this step is that there may be multiple antepartum periods corresponding to different pregnancies that are less than nine months apart (e.g., in cases where a miscarriage occurs).

If an appropriate Antepartum Folder cannot be found it shall be created by:

- 1125 1. Creating a new Folder using the 57082-0 Antepartum Records code from LOINC or the code required by the National Extension.
2. The folder should have a name identifying it as an Antepartum Folder, and should have an indication of which antepartum period it references so that it can be readily verified by a provider. For example, the date that the Antepartum Period started, or the number of this pregnancy (e.g, Antepartum Record starting 2/2/2010, or Antepartum Record for Pregnancy 1).

1130 The APHP, APE, APL, or APS documents are placed in the the folder that was found or created. Other documents known to be part of, or relevant to Antepartum care, may also follow this protocol. For example, documents describing fertility treatment leading to conception may also be included in the Antepartum folder.

### **6.2.L Labor and Delivery Folder Specification**

1135 The Labor and Delivery Folder contains information from the Labor and Delivery period of a pregnancy.

1140 This folder should be coded as required for the Region where it is used. A recommended code to use is 15508-5 Labor and Delivery Records from LOINC. The Labor and Delivery Folder contains a set of documents describing care given during the Labor and Delivery period of a pregnancy. This period is defined as the period between onset of Labor and its completion or termination.

1145 Under exceptional conditions a pregnancy can have multiple periods of labor and delivery which may also overlap the antepartum period. For example, a premature labor may occur which is successfully stopped. A separate Labor and Delivery Folder shall be created for each episode of labor experienced by the mother. The definition of episode of labor should be coordinated with regional or local policies where they exist. If no such policy exists, we recommend that two occurrences of labor in a 24 hour period be treated as a single episode of labor.

1150 The Labor and Delivery Folder is expected to contain documents conforming to the content specifications for the Labor and Delivery History and Physical (LDHP), Labor and Delivery Summary (LDS), and Maternal Discharge Summary (MDS). In addition, it may contain other documents such as imaging studies (XDS-I), laboratory results (XD-LAB), or other content pertinent to the labor and delivery care of the patient.

When an LDHP, LDS, or MDS document is shared, the Content Creator shall:

- 1155 1. Determine the appropriate Labor and Delivery Folder to use for sharing  
or
2. Create a Labor and Delivery Folder if an appropriate one does not already exist.

The first step is completed by:

1. Locating the most recently updated Labor and Delivery Folder for the patient (either on existing XDM media being updated, or in an XDS registry).
2. Verifying that this folder is correct. The reason for this step is that there may be multiple labor and delivery episodes for a single pregnancy as described above.

If an appropriate Labor and Delivery Folder cannot be found it shall be created by:

1. Creating a new Folder using the 15508-5 Labor and Delivery Records from LOINC or the code required by the National Extension.
2. The folder should have a name identifying it as a Labor and Delivery Folder, and should have an indication of which labor and delivery period it references so that it can be readily verified by a provider. For example, the date that the Labor started (Labor starting 2/2/2010).

Placing the newly submitted document(s) in that folder.

Other documents known to be part of Labor and Delivery care may also follow this protocol.

- 1170 When the Labor and Delivery Folder is created, the submitter shall locate the most recent Antepartum Folder, verify that it is correct, locate the most recent Antepartum Summary in that folder, and ensure that document also appears in the newly created Labor and Delivery Folder.

There are additional requirements when a Maternal Discharge Summary (MDS) is shared, see Postpartum Folder below.

## 1175 **6.2.N Newborn Folder Specification**

The Newborn Folder contains information about a newborn child.

- 1180 This folder should be coded as required for the Region where it is used. A recommended code to use is X-Newborn Records from LOINC. The Newborn Folder contains a set of documents describing care given during the Newborn period of a child. This period is defined as the period between delivery and the beginning of the neonatal period (usually one month according to various regional policies).

- 1185 The Newborn Folder is expected to contain documents conforming to the content specifications for the Labor and Delivery Summary (LDS), Newborn Discharge Summary (MDS) and Newborn Screening (NBS) profiles. In addition, it may contain other documents such as imaging studies (XDS-I), laboratory results (XD-LAB), or other content pertinent to care of the newborn.

When an NDS or NBS document is shared, the Content Creator shall:

1. Determine the appropriate Newborn Folder to use for sharing  
or
- 1190 2. Create a Newborn Folder if an appropriate one does not already exist.

The first step is completed by:

1. Locating the most recently updated Newborn Folder for the newborn (either on existing XDM media being updated, or in an XDS registry).
2. Verifying that this folder is correct.

1195 If an appropriate Newborn Folder cannot be found it shall be created by:

1. Creating a new Folder using the X-Newborn Records from LOINC or the code required by the National Extension.
2. The folder should have a name identifying it as a Newborn Folder.

Placing the newly submitted document(s) in that folder.

1200 Other documents known to be part of Newborn care may also follow this protocol.

When the Newborn Folder is created, the submitter shall locate the most recently updated Labor and Delivery Folder for the mother, verify that it is correct, locate the most recent Labor and Delivery Summary in that folder, and ensure that document also appears in the newly created Newborn Folder. This capability must be able to be overridden in certain scenarios where the connection between the mother and newborn should not be made (e.g., in cases of a newborn being placed for adoption).

1205

### **6.2.P Postpartum Folder Specification**

The mother's Postpartum Folder contains information from the Postpartum period of a pregnancy.

1210 This folder should be coded as required for the Region where it is used. A recommended code to use is X-Postpartum Records from LOINC. The Postpartum Folder contains a set of documents describing care given during the Postpartum period of a pregnancy. This period is defined as the period between Delivery and the final follow up visit with the provider of obstetric care in the outpatient setting.

1215 The Postpartum Folder is expected to contain documents conforming to the content specifications for the, Labor and Delivery Summary (LDS), Maternal Discharge Summary (MDS), and Postpartum Visit Summary (PPVS). In addition, it may contain other documents such as imaging studies (XDS-I), laboratory results (XD-LAB), or other content pertinent to the Postpartum care of the patient.

1220 When an MDS or PPVS document is shared, the Content Creator shall:

1. Determine the appropriate Postpartum Folder to use for sharing  
or
2. Create a Postpartum Folder if an appropriate one does not already exist.

The first step is completed by:



- 1225
1. Locating the most recently updated Postpartum Folder for the patient (either on existing XDM media being updated, or in an XDS registry).
  2. Verifying that this folder is correct.

If an appropriate Postpartum Folder cannot be found it shall be created by:

- 1230
1. Creating a new Folder using the X-Postpartum Records from LOINC or the code required by the National Extension.
  2. The folder should have a name identifying it as a Postpartum Folder

Placing the newly submitted document(s) in that folder.

Other documents known to be part of Newborn care may also follow this protocol.

- 1235
- When the Postpartum Folder is created, the submitter shall locate the most recent Labor and Delivery Folder, verify that it is correct, locate the most recent Labor and Delivery Summary (LDS) and Maternal Discharge Summary (MDS) in that folder, and ensure the LDS and MDS also appear in the newly created Postpartum Folder.