

Integrating the Healthcare Enterprise



5

**IHE Radiology (RAD)
Technical Framework**

10

**Volume 2
IHE RAD TF-2
Transactions**

15

20

**Revision 16.0 Final Text
August 4, 2017**

25

Please verify you have the most recent version of this document, which is published [here](#).

CONTENTS

30	1	Introduction	18
	1.1	Overview of Technical Framework	18
	1.2	Overview of Volume 2.....	19
	1.3	Audience	19
	1.4	Relationship to Standards	19
35	1.5	Relationship to Real-world Architectures.....	20
	1.6	Comments	20
	1.7	Copyright Permission.....	21
	2	Conventions	22
	2.1	The Generic IHE Transaction Model.....	22
40	2.2	DICOM Usage Conventions	23
	2.3	HL7 Profiling Conventions.....	25
	2.3.1	Static definition – Segment level and Data Type level.....	26
	2.3.2	Static definition - Message level.....	28
	2.4	HL7 Implementation Notes.....	29
45	2.4.1	Common HL7 Message Implementation Requirements.....	29
	2.4.1.1	Network Guidelines.....	29
	2.4.1.2	Acknowledgement Mode.....	29
	2.4.1.3	HL7 Versioning	29
	2.4.1.4	Empty Field	30
50	2.4.1.5	Z-Segment	30
	2.4.2	HL7 v2.3.1 Message Implementation Requirements	30
	2.4.2.1	Acknowledgement Message.....	30
	2.4.2.2	Message Control.....	30
	2.4.2.3	Acknowledgement Modes	31
55	2.4.2.4	ERR – Error Segment.....	31
	2.4.3	HL7 v2.4 Message Implementation Requirements	32
	2.4.4	HL7 v2.5 Message Implementation Requirements	32
	2.4.4.1	Acknowledgement Message.....	32
	2.4.4.2	Message Control.....	32
60	2.4.4.3	Acknowledgement Modes	35
	2.4.4.4	ERR - Error segment	35
	2.5	HL7 and DICOM Mapping Considerations.....	37
	2.6	Use of Coded Entities and Coding Schemes.....	37
	3	Framework Overview.....	38
65	4	IHE Transactions.....	39
	4.1	Patient Registration [RAD-1]	39
	4.1.1	Scope.....	39
	4.1.2	Use Case Roles	39
	4.1.3	Referenced Standards	40
70	4.1.4	Interaction Diagram	40

	4.1.4.1 Patient Management – Admit/Register Patient	40
	4.1.4.1.1 Trigger Events.....	40
	4.1.4.1.2 Message Semantics	40
75	4.1.4.1.2.1 Message Semantics (HL7 v2.3.1).....	40
	4.1.4.1.2.1.1 MSH Segment (HL7 v2.3.1)	41
	4.1.4.1.2.1.2 EVN Segment (HL7 v2.3.1).....	41
	4.1.4.1.2.1.3 PID Segment (HL7 v2.3.1).....	42
	4.1.4.1.2.1.4 PV1 Segment (HL7 v2.3.1).....	43
	4.1.4.1.2.1.5 AL1 Segment (HL7 v2.3.1).....	45
80	4.1.4.1.2.1.6 OBX Segment (HL7 v2.3.1).....	45
	4.1.4.1.2.2 Message Semantics (HL7 v2.5.1 Option).....	46
	4.1.4.1.2.2.1 MSH Segment (HL7 v2.5.1 Option)	47
	4.1.4.1.2.2.2 EVN Segment (HL7 v2.5.1 Option).....	47
	4.1.4.1.2.2.3 PID Segment (HL7 v2.5.1 Option).....	47
85	4.1.4.1.2.2.4 PV1 Segment (HL7 v2.5.1 Option).....	48
	4.1.4.1.2.2.5 ROL Segment (HL7 v2.5.1 Option).....	49
	4.1.4.1.2.2.6 OBX Segment (HL7 v2.5.1 Option).....	49
	4.1.4.1.2.2.7 AL1 Segment (HL7 v2.5.1 Option).....	49
	4.1.4.1.3 Expected Actions	49
90	4.1.4.2 Patient Management – Cancel Admit/Register Patient	50
	4.1.4.2.1 Trigger Events.....	50
	4.1.4.2.2 Message Semantics	50
	4.1.4.2.2.1 Message Semantics (HL7 v2.3.1).....	50
95	4.1.4.2.2.1.1 MSH Segment (HL7 v2.3.1)	51
	4.1.4.2.2.1.2 EVN Segment (HL7 v2.3.1).....	51
	4.1.4.2.2.1.3 PID Segment (HL7 v2.3.1).....	51
	4.1.4.2.2.1.4 PV1 Segment (HL7 v2.3.1).....	51
	4.1.4.2.2.2 Message Semantics (HL7 v2.5.1 Option).....	52
100	4.1.4.2.2.2.1 MSH Segment (HL7 v2.5.1 Option)	52
	4.1.4.2.2.2.2 EVN Segment (HL7 v2.5.1 Option).....	52
	4.1.4.2.2.2.3 PID Segment (HL7 v2.5.1 Option).....	52
	4.1.4.2.2.2.4 PV1 Segment (HL7 v2.5.1 Option).....	53
	4.1.4.2.3 Expected Actions	53
105	4.2 Placer Order Management [RAD-2].....	54
	4.2.1 Scope.....	54
	4.2.2 Use Case Roles	54
	4.2.3 Referenced Standards	54
	4.2.4 Interaction Diagram	54
	4.2.4.1 Order Management – New Order from Order Placer	55
110	4.2.4.1.1 Trigger Events.....	55
	4.2.4.1.2 Message Semantics	55
	4.2.4.1.2.1 Message Semantics (HL7 v2.3.1).....	55
	4.2.4.1.2.1.1 MSH Segment (HL7 v2.3.1)	56
	4.2.4.1.2.1.2 PID Segment (HL7 v2.3.1).....	56

115	4.2.4.1.2.1.3 PV1 Segment (HL7 v2.3.1).....	56
	4.2.4.1.2.1.4 ORC Segment (HL7 v2.3.1).....	57
	4.2.4.1.2.1.5 OBR Segment (HL7 v2.3.1).....	58
	4.2.4.1.2.2 Message Semantics (HL7 v2.5.1 Option).....	60
	4.2.4.1.2.2.1 MSH Segment (HL7 v2.5.1 Option)	60
120	4.2.4.1.2.2.2 PID Segment (HL7 v2.5.1 Option).....	61
	4.2.4.1.2.2.3 PV1 Segment (HL7 v2.5.1 Option).....	61
	4.2.4.1.2.2.4 ORC Segment (HL7 v2.5.1 Option).....	61
	4.2.4.1.2.2.5 TQ1 Segment (HL7 v2.5.1 Option).....	63
	4.2.4.1.2.2.6 OBR Segment (HL7 v2.5.1 Option).....	64
125	4.2.4.1.3 Expected Actions	66
	4.2.4.2 Order Management - Order Cancelled by Order Placer	66
	4.2.4.2.1 Trigger Events.....	66
	4.2.4.2.2 Message Semantics	66
	4.2.4.2.2.1 Message Semantics (HL7 v.2.3.1).....	66
130	4.2.4.2.2.1.1 MSH Segment (HL7 v2.3.1)	67
	4.2.4.2.2.1.2 PID Segment (HL7 v2.3.1).....	67
	4.2.4.2.2.1.3 PV1 Segment (HL7 v2.3.1).....	67
	4.2.4.2.2.1.4 ORC Segment (HL7 v2.3.1).....	68
	4.2.4.2.2.2 Message Semantics (HL7 v2.5.1 Option).....	68
135	4.2.4.2.2.2.1 MSH Segment (HL7 v2.5.1 Option)	69
	4.2.4.2.2.2.2 PID Segment (HL7 v2.5.1 Option).....	69
	4.2.4.2.2.2.3 PV1 Segment (HL7 v2.5.1 Option).....	69
	4.2.4.2.2.2.4 ORC Segment (HL7 v2.5.1 Option).....	70
	4.2.4.2.3 Expected Actions	70
140	4.3 Filler Order Management [RAD-3]	71
	4.3.1 Scope.....	71
	4.3.2 Use Case Roles	71
	4.3.3 Referenced Standards	71
	4.3.4 Interaction Diagram	71
145	4.3.4.1 Filler Order Management – New Order from Order Filler or Change Order from Order Filler	72
	4.3.4.1.1 Trigger Events.....	72
	4.3.4.1.2 Message Semantics	73
	4.3.4.1.2.1 Message Semantics (HL7 v2.3.1).....	73
150	4.3.4.1.2.1.1 MSH Segment (HL7 v2.3.1)	74
	4.3.4.1.2.1.2 MSA Segment (HL7 v2.3.1)	74
	4.3.4.1.2.1.3 PID Segment (HL7 v2.3.1).....	74
	4.3.4.1.2.1.4 PV1 Segment (HL7 v2.3.1).....	74
	4.3.4.1.2.1.5 ORC Segment (HL7 v2.3.1).....	75
155	4.3.4.1.2.1.6 OBR Segment (HL7 v2.3.1).....	75
	4.3.4.1.2.1.7 ERR Segment (HL7 v2.3.1)	76
	4.3.4.1.2.2 Message Semantics (HL7 v2.5.1 Option).....	76
	4.3.4.1.2.2.1 MSH Segment (HL7 v2.5.1 Option)	77

	4.3.4.1.2.2.2 MSA Segment (HL7 v2.5.1 Option)	78
160	4.3.4.1.2.2.3 PID Segment (HL7 v2.5.1 Option).....	78
	4.3.4.1.2.2.4 PV1 Segment (HL7 v2.5.1 Option).....	78
	4.3.4.1.2.2.5 ORC Segment (HL7 v2.5.1 Option).....	79
	4.3.4.1.2.2.6 TQ1 Segment (HL7 v2.5.1 Option).....	79
	4.3.4.1.2.2.7 OBR Segment (HL7 v2.5.1 Option).....	80
165	4.3.4.1.2.2.8 ERR Segment (HL7 v2.5.1 Option)	81
	4.3.4.1.3 Expected Actions	81
	4.3.4.2 Filler Order Management - Order Status Update	81
	4.3.4.2.1 Trigger Events.....	81
	4.3.4.2.2 Message Semantics	82
170	4.3.4.2.2.1 Message Semantics (HL7 v2.3.1).....	82
	4.3.4.2.2.1.1 MSH Segment (HL7 v2.3.1)	82
	4.3.4.2.2.1.2 ORC Segment (HL7 v2.3.1).....	82
	4.3.4.2.2.2 Message Semantics (HL7 v2.5.1 Option).....	83
	4.3.4.2.2.2.1 MSH Segment (HL7 v2.5.1 Option)	83
175	4.3.4.2.2.2.2 ORC Segment (HL7 v2.5.1 Option).....	83
	4.3.4.2.2.2.3 TQ1 Segment (HL7 v2.5.1 Option).....	84
	4.3.4.2.2.2.4 OBR Segment (HL7 v2.5.1 Option).....	85
	4.3.4.2.3 Expected Actions	85
	4.3.4.3 Filler Order Management - Order Cancelled by the Order Filler.....	86
180	4.3.4.3.1 Trigger Events.....	86
	4.3.4.3.2 Message Semantics	86
	4.3.4.3.2.1 Message Semantics (HL7 v2.3.1).....	86
	4.3.4.3.2.1.1 MSH Segment (HL7 v2.3.1)	86
	4.3.4.3.2.1.2 PID Segment (HL7 v2.3.1).....	87
185	4.3.4.3.2.1.3 PV1 Segment (HL7 v2.3.1)	87
	4.3.4.3.2.1.4 ORC Segment (HL7 v2.3.1).....	87
	4.3.4.3.2.2 Message Semantics (HL7 v2.5.1 Option).....	88
	4.3.4.3.2.2.1 MSH Segment (HL7 v2.5.1 Option)	88
	4.3.4.3.2.2.2 PID Segment (HL7 v2.5.1 Option).....	89
190	4.3.4.3.2.2.3 PV1 Segment (HL7 v2.5.1 Option).....	89
	4.3.4.3.2.2.4 ORC Segment (HL7 v2.5.1 Option).....	89
	4.3.4.3.2.2.5 OBR Segment (HL7 v2.5.1 Option).....	90
	4.3.4.3.3 Expected Actions	90
	4.4 Procedure Scheduled [RAD-4]	91
195	4.4.1 Scope.....	91
	4.4.2 Use Case Roles	92
	4.4.3 Referenced Standards	92
	4.4.4 Interaction Diagram	92
	4.4.4.1 Procedure Scheduled Message	94
200	4.4.4.1.1 Trigger Events.....	94
	4.4.4.1.2 Message Semantics	95
	4.4.4.1.2.1 Message Semantics (HL7 v2.3.1).....	95

	4.4.4.1.2.1.1 MSH Segment (HL7 v2.3.1)	95
	4.4.4.1.2.1.2 PID Segment (HL7 v2.3.1).....	95
205	4.4.4.1.2.1.3 PV1 Segment (HL7 v2.3.1).....	96
	4.4.4.1.2.1.4 ORC Segment (HL7 v2.3.1).....	97
	4.4.4.1.2.1.5 OBR Segment (HL7 v2.3.1).....	98
	4.4.4.1.2.2 Message Semantics (HL7 v2.5.1 Option).....	101
210	4.4.4.1.2.2.1 MSH Segment (HL7 v2.5.1 Option)	102
	4.4.4.1.2.2.2 PID Segment (HL7 v2.5.1 Option).....	102
	4.4.4.1.2.2.3 PV1 Segment (HL7 v2.5.1 Option).....	102
	4.4.4.1.2.2.4 ROL Segment (HL7 v2.5.1 Option).....	103
	4.4.4.1.2.2.5 ORC Segment (HL7 v2.5.1 Option).....	104
215	4.4.4.1.2.2.6 TQ1 Segment (HL7 v2.5.1 Option).....	105
	4.4.4.1.2.2.7 OBR Segment (HL7 v2.5.1 Option).....	106
	4.4.4.1.2.2.8 IPC Segment (HL7 v2.5.1 Option).....	107
	4.4.4.2 Expected Actions.....	108
	4.4.4.2.1 Use Cases	108
220	4.5 Query Modality Worklist [RAD-5]	111
	4.5.1 Scope.....	111
	4.5.2 Use Case Roles	111
	4.5.3 Referenced Standards	112
	4.5.4 Interaction Diagram	112
225	4.5.4.1 Query Scheduled MWL Message.....	112
	4.5.4.1.1 Trigger Events.....	113
	4.5.4.1.2 Message Semantics	113
	4.5.4.1.2.1 Examples for the Use of Matching Key Attributes	114
	4.5.4.1.2.2 Matching Keys and Return Keys.....	114
	4.5.4.1.3 Expected Actions	117
230	4.5.4.2 Receive Scheduled MWL Message.....	117
	4.5.4.2.1 Trigger Events.....	117
	4.5.4.2.2 Message Semantics	117
	4.5.4.2.2.1 Scheduled Protocol Sequence for Import	118
	4.5.4.2.3 Expected Actions	119
235	4.6 Modality Procedure Step In Progress [RAD-6].....	120
	4.6.1 Scope.....	120
	4.6.2 Use Case Roles	121
	4.6.3 Referenced Standards	121
240	4.6.4 Interaction Diagram	122
	4.6.4.1 Procedure Step In Progress Message.....	122
	4.6.4.1.1 Trigger Event	122
	4.6.4.1.2 Message Semantics	122
	4.6.4.1.2.1 Patient/Procedure/Scheduled Procedure Step Information.....	123
245	4.6.4.1.2.2 Required Attributes.....	123
	4.6.4.1.2.3 Relationship between Scheduled and Performed Procedure Steps..	123
	4.6.4.1.2.3.1 Simple Case	123

	4.6.4.1.2.3.2	Unscheduled Case	123
	4.6.4.1.2.3.3	Append Case.....	124
	4.6.4.1.2.3.4	Group Case	125
250	4.6.4.1.2.3.5	Abandoned Case.....	126
	4.6.4.1.2.3.6	Group Case with Presentation of Grouped Procedures	126
	4.6.4.1.2.4	Protocol Handling.....	128
	4.6.4.1.2.4.1	Manual Modality Setting.....	128
	4.6.4.1.2.4.2	Assisted Acquisition Protocol Setting Option	129
255	4.6.4.1.3	Expected Actions	131
	4.7	Modality Procedure Step Completed/Discontinued [RAD-7]	132
	4.7.1	Scope.....	132
	4.7.2	Use Case Roles	132
	4.7.3	Referenced Standards	133
260	4.7.4	Interaction Diagram	133
	4.7.4.1	Procedure Step Completed/Discontinued.....	133
	4.7.4.1.1	Trigger Event	133
	4.7.4.1.2	Message Semantics	133
	4.7.4.1.2.1	Retrieve AE Title.....	134
265	4.7.4.1.2.2	PPS Exception Management Option	134
	4.7.4.1.2.3	Billing and Material Management Information.....	136
	4.7.4.1.2.4	Protocol Handling.....	137
	4.7.4.1.3	Expected Actions	137
	4.7.4.1.3.1	PPS Exception Management Option	137
270	4.7.4.1.3.2	Billing and Material Management Information.....	138
	4.8	Modality Images Stored [RAD-8]	139
	4.8.1	Scope.....	139
	4.8.2	Use Case Roles	139
	4.8.3	Referenced Standards	139
275	4.8.4	Interaction Diagram	140
	4.8.4.1	Images Stored	140
	4.8.4.1.1	Trigger Events.....	140
	4.8.4.1.1.1	Study UIDs and Series UIDs	140
	4.8.4.1.2	Message Semantics	141
280	4.8.4.1.2.1	Storage of Localizer Images (MR and CT)	141
	4.8.4.1.2.2	Storage of NM Images (NMI)	141
	4.8.4.1.2.3	Storage of Full Field Digital Mammography Images.....	144
	4.8.4.1.2.3.1	Partial View Option.....	147
	4.8.4.1.2.3.2	Background Air Suppression	147
285	4.8.4.1.2.3.3	Cleavage Views.....	147
	4.8.4.1.2.3.4	Digitized Film	147
	4.8.4.1.2.4	Recording of Dose Information.....	148
	4.8.4.1.2.5	Storage of Enhanced DICOM Objects	148
	4.8.4.1.2.6	Storage of Stereotactic Mammography Images.....	148
290	4.8.4.1.2.7	Storage of Digital Breast Tomosynthesis Images.....	149

	4.8.4.1.2.7.1 Partial View Option.....	153
	4.8.4.1.3 Expected Actions	153
	4.8.4.1.3.1 DICOM Image Storage SOP Classes	153
	4.9 Modality Presentation State Stored [RAD-9]	156
295	4.9.1 Scope.....	156
	4.9.2 Use Case Roles	156
	4.9.3 Referenced Standards	156
	4.9.4 Interaction Diagram	157
	4.9.4.1 Modality Presentation State Stored	157
300	4.9.4.1.1 Trigger Events.....	157
	4.9.4.1.2 Message Semantics	157
	4.9.4.1.3 Expected Actions	157
	4.10 Storage Commitment [RAD-10].....	158
	4.10.1 Scope	158
305	4.10.2 Use Case Roles	158
	4.10.3 Referenced Standards	158
	4.10.4 Interaction Diagram.....	159
	4.10.4.1 Images Committed.....	159
	4.10.4.1.1 Trigger Events.....	159
310	4.10.4.1.2 Message Semantics	159
	4.10.4.1.3 Expected Actions	160
	4.11 Image Availability Query [RAD-11].....	161
	4.11.1 Scope	161
	4.11.2 Use Case Roles	162
315	4.11.3 Referenced Standards	162
	4.11.4 Interaction Diagram.....	162
	4.11.4.1 Query Image Availability	163
	4.11.4.1.1 Trigger Events.....	163
	4.11.4.1.2 Message Semantics	163
320	4.11.4.1.3 Expected Actions	164
	4.12 Patient Update [RAD-12]	165
	4.12.1 Scope	165
	4.12.2 Use Case Roles	165
	4.12.3 Referenced Standards	166
325	4.12.4 Interaction Diagram.....	166
	4.12.4.1 Patient Management – Patient Transfer	167
	4.12.4.1.1 Trigger Events.....	167
	4.12.4.1.2 Message Semantics	167
	4.12.4.1.2.1 Message Semantics (HL7 v2.3.1).....	167
330	4.12.4.1.2.1.1 MSH Segment (HL7 v2.3.1)	167
	4.12.4.1.2.1.2 EVN Segment (HL7 v2.3.1).....	167
	4.12.4.1.2.1.3 PID Segment (HL7 v2.3.1)	167
	4.12.4.1.2.1.4 PV1 Segment (HL7 v2.3.1).....	168
	4.12.4.1.2.2 Message Semantics (HL7 v2.5.1 Option).....	168

335	4.12.4.1.2.2.1	MSH Segment (HL7 v2.5.1 Option)	169
	4.12.4.1.2.2.2	EVN Segment (HL7 v2.5.1 Option).....	169
	4.12.4.1.2.2.3	PID Segment (HL7 v2.5.1 Option)	169
	4.12.4.1.2.2.4	PV1 Segment (HL7 v2.5.1 Option).....	169
	4.12.4.1.2.2.5	ROL Segment (HL7 v2.5.1 Option).....	170
340	4.12.4.1.3	Expected Actions	170
	4.12.4.2	Patient Management – Update Patient Class	171
	4.12.4.2.1	Trigger Events.....	171
	4.12.4.2.2	Message Semantics	171
	4.12.4.2.2.1	Message Semantics (HL7 v2.3.1).....	171
345	4.12.4.2.2.1.1	MSH Segment (HL7 v2.3.1)	171
	4.12.4.2.2.1.2	EVN Segment (HL7 v2.3.1).....	172
	4.12.4.2.2.1.3	PID Segment (HL7 v2.3.1)	172
	4.12.4.2.2.1.4	PV1 Segment (HL7 v2.3.1).....	172
	4.12.4.2.2.2	Message Semantics (HL7 v2.5.1 Option).....	173
350	4.12.4.2.2.2.1	MSH Segment (HL7 v2.5.1 Option)	174
	4.12.4.2.2.2.2	EVN Segment (HL7 v2.5.1 Option).....	174
	4.12.4.2.2.2.3	PID Segment (HL7 v2.5.1 Option)	174
	4.12.4.2.2.2.4	PV1 Segment (HL7 v2.5.1 Option).....	175
	4.12.4.2.2.2.5	ROL Segment (HL7 v2.5.1 Option).....	176
355	4.12.4.2.3	Expected Actions	176
	4.12.4.3	Patient Management – Patient Information Update.....	176
	4.12.4.3.1	Trigger Events.....	176
	4.12.4.3.2	Message Semantics	177
	4.12.4.3.2.1	Message Semantics (HL7 v2.3.1).....	177
360	4.12.4.3.2.1.1	MSH Segment (HL7 v2.3.1)	177
	4.12.4.3.2.1.2	EVN Segment (HL7 v2.3.1).....	178
	4.12.4.3.2.1.3	PID Segment (HL7 v2.3.1)	178
	4.12.4.3.2.1.4	PV1 Segment (HL7 v2.3.1).....	178
	4.12.4.3.2.1.5	AL1 Segment (HL7 v2.3.1).....	178
365	4.12.4.3.2.1.6	OBX Segment (HL7 v2.3.1)	178
	4.12.4.3.2.2	Message Semantics (HL7 v2.5.1 Option).....	179
	4.12.4.3.2.2.1	MSH Segment (HL7 v2.5.1 Option)	179
	4.12.4.3.2.2.2	EVN Segment (HL7 v2.5.1 Option).....	179
	4.12.4.3.2.2.3	PID Segment (HL7 v2.5.1 Option)	179
370	4.12.4.3.2.2.4	PV1 Segment (HL7 v2.5.1 Option).....	180
	4.12.4.3.2.2.5	OBX Segment (HL7 v2.5.1 Option)	180
	4.12.4.3.2.2.6	AL1 Segment (HL7 v2.5.1 Option)	180
	4.12.4.3.3	Expected Actions	180
	4.12.4.4	Patient Management – Patient Merge	181
375	4.12.4.4.1	Trigger Events.....	181
	4.12.4.4.2	Message Semantics	181
	4.12.4.4.2.1	Message Semantics (HL7 v2.3.1).....	181
	4.12.4.4.2.1.1	MSH Segment (HL7 v2.3.1)	181

	4.12.4.4.2.1.2	EVN Segment (HL7 v2.3.1).....	182
380	4.12.4.4.2.1.3	PID Segment (HL7 v2.3.1)	182
	4.12.4.4.2.1.4	PV1 Segment (HL7 v2.3.1).....	182
	4.12.4.4.2.1.5	MRG Segment (HL7 v2.3.1).....	182
	4.12.4.4.2.2	Message Semantics (HL7 v2.5.1 Option).....	183
	4.12.4.4.2.2.1	MSH Segment (HL7 v2.5.1 Option)	183
385	4.12.4.4.2.2.2	EVN Segment (HL7 v2.5.1 Option).....	183
	4.12.4.4.2.2.3	PID Segment (HL7 v2.5.1 Option)	183
	4.12.4.4.2.2.4	PV1 Segment (HL7 v2.5.1 Option).....	184
	4.12.4.4.2.2.5	MRG Segment (HL7 v2.5.1 Option).....	184
	4.12.4.4.3	Expected Actions	185
390	4.12.4.5	Patient Management – Cancel Patient Transfer/Discharge	185
	4.12.4.5.1	Trigger Events.....	185
	4.12.4.5.2	Message Semantics	185
	4.12.4.5.2.1	Message Semantics (HL7 v2.3.1).....	185
	4.12.4.5.2.1.1	MSH Segment (HL7 v2.3.1)	186
395	4.12.4.5.2.1.2	EVN Segment (HL7 v2.3.1).....	186
	4.12.4.5.2.1.3	PID Segment (HL7 v2.3.1)	186
	4.12.4.5.2.1.4	PV1 Segment (HL7 v2.3.1).....	186
	4.12.4.5.2.2	Message Semantics (HL7 v2.5.1 Option).....	187
	4.12.4.5.2.2.1	MSH Segment (HL7 v2.5.1 Option)	187
400	4.12.4.5.2.2.2	EVN Segment (HL7 v2.5.1 Option).....	187
	4.12.4.5.2.2.3	PID Segment (HL7 v2.5.1 Option)	187
	4.12.4.5.2.2.4	PV1 Segment (HL7 v2.5.1 Option).....	188
	4.12.4.5.3	Expected Actions	188
	4.13	Procedure Update [RAD-13]	189
405	4.13.1	Scope	189
	4.13.2	Use Case Roles	189
	4.13.3	Referenced Standards	190
	4.13.4	Interaction Diagram.....	190
	4.13.4.1	Trigger Events.....	191
410	4.13.4.2	Message Semantics	191
	4.13.4.2.1	Message Semantics (HL7 v2.3.1)	191
	4.13.4.2.2	Message Semantics (HL7 v2.5.1)	193
	4.13.4.3	Expected Actions	194
	4.14	Query Images [RAD-14].....	195
415	4.14.1	Scope	195
	4.14.2	Use Case Roles	195
	4.14.3	Referenced Standards	195
	4.14.4	Interaction Diagram.....	196
	4.14.4.1	Query Images	196
420	4.14.4.1.1	Trigger Events.....	196
	4.14.4.1.2	Message Semantics	196
	4.14.4.1.3	Expected Actions	200

	4.15 Query Presentation States [RAD-15].....	201
	4.15.1 Scope	201
425	4.15.2 Use Case Roles	201
	4.15.3 Referenced Standards	201
	4.15.4 Interaction Diagram.....	202
	4.15.4.1 Query for Grayscale Softcopy Presentation States	202
	4.15.4.1.1 Trigger Events.....	202
430	4.15.4.1.2 Message Semantics	202
	4.15.4.1.3 Expected Actions	203
	4.16 Retrieve Images [RAD-16].....	204
	4.16.1 Scope	204
	4.16.2 Use Case Roles	204
435	4.16.3 Referenced Standards	204
	4.16.4 Interaction Diagram.....	205
	4.16.4.1 Retrieve Images	205
	4.16.4.1.1 Trigger Events.....	206
	4.16.4.1.2 Message Semantics	206
440	4.16.4.1.3 Expected Actions	206
	4.16.4.1.3.1 NM Image Profile	206
	4.16.4.1.3.2 Mammography Image Profile	206
	4.16.4.1.3.3 Basic Image Review Profile.....	206
	4.16.4.1.3.4 MR Diffusion Imaging Profile.....	207
445	4.16.4.1.3.5 CT/MR Perfusion Imaging with Contrast Profile.....	207
	4.16.4.1.3.6 Stereotactic Mammography Image Profile.....	207
	4.16.4.1.3.7 Digital Breast Tomosynthesis Profile	207
	4.16.4.2 View Images	207
	4.16.4.2.1 Trigger Events.....	207
450	4.16.4.2.2 Invocation Semantics	207
	4.16.4.2.2.1 Display of Digital X-Ray, Mammo and Intra-Oral Images	208
	4.16.4.2.2.1.1 Display of Digital Mammography Images.....	208
	4.16.4.2.2.1.2 Display of Stereotactic Mammography Images	217
	4.16.4.2.2.1.3 Display of DBT Images	217
455	4.16.4.2.2.2 Display of Localizer Lines.....	225
	4.16.4.2.2.3 Display of NM Images.....	225
	4.16.4.2.2.3.1 Frame Selection Support	227
	4.16.4.2.2.3.2 Display Capabilities	229
	4.16.4.2.2.3.3 Intensity and Color	230
460	4.16.4.2.2.3.4 Image Zoom	231
	4.16.4.2.2.3.5 Review Option	231
	4.16.4.2.2.4 Display of Result Screens	231
	4.16.4.2.3 Expected Actions	232
	4.16.4.2.3.1 NM Image Specifics	232
465	4.17 Retrieve Presentation States [RAD-17]	233
	4.17.1 Scope	233

	4.17.2	Use Case Roles	233
	4.17.3	Referenced Standards	234
	4.17.4	Interaction Diagram	234
470	4.17.4.1	Retrieve Grayscale Softcopy Presentation State	235
	4.17.4.1.1	Trigger Events	235
	4.17.4.1.2	Message Semantics	235
	4.17.4.1.3	Expected Actions	236
	4.17.4.2	View Presentation States	236
475	4.17.4.2.1	Trigger Events	236
	4.17.4.2.2	Invocation Semantics	236
	4.17.4.2.3	Expected Actions	236
	4.18	Creator Images Stored [RAD-18]	237
	4.18.1	Scope	237
480	4.18.2	Use Case Roles	237
	4.18.3	Referenced Standards	237
	4.18.4	Interaction Diagram	238
	4.18.4.1	Images Stored	238
	4.18.4.1.1	Trigger Events	238
485	4.18.4.1.2	Message Semantics	238
	4.18.4.1.2.1	Storage of Localizer Images (MR and CT)	239
	4.18.4.1.2.2	Storage of NM Images (NM)	239
	4.18.4.1.2.3	Storage of Cardiac Images (NM)	239
	4.18.4.1.2.4	Result Screen Export Option	239
490	4.18.4.1.2.5	Storage of DBT Reconstructions	241
	4.18.4.1.3	Expected Actions	241
	4.18.4.1.3.1	DICOM Image Storage SOP Classes	242
	4.19	Creator Presentation State Stored [RAD-19]	243
	4.19.1	Scope	243
495	4.19.2	Use Case Roles	243
	4.19.3	Referenced Standards	243
	4.19.4	Interaction Diagram	244
	4.19.4.1	Creator Presentation State Stored	244
	4.19.4.1.1	Trigger Events	244
500	4.19.4.1.2	Message Semantics	244
	4.19.4.1.3	Expected Actions	245
	4.20	Creator Procedure Step In Progress [RAD-20]	246
	4.20.1	Scope	246
	4.20.2	Use Case Roles	246
505	4.20.3	Referenced Standards	247
	4.20.4	Interaction Diagram	247
	4.20.4.1	Procedure Step Started Message	247
	4.20.4.1.1	Trigger Event	247
	4.20.4.1.2	Message Semantics	247
510	4.20.4.1.2.1	Patient/Procedure/Procedure Step Information	247

	4.20.4.1.2.2	Required Attributes.....	248
	4.20.4.1.2.3	Relationship between Scheduled and Performed Procedure Steps..	248
	4.20.4.1.2.3.1	Append Case	248
	4.20.4.1.3	Expected Actions	249
515	4.21	Creator Procedure Step Completed [RAD-21]	250
	4.21.1	Scope	250
	4.21.2	Use Case Roles	250
	4.21.3	Referenced Standards	250
	4.21.4	Interaction Diagram.....	251
520	4.21.4.1	Procedure Step Completed/Discontinued	251
	4.21.4.1.1	Trigger Event	251
	4.21.4.1.2	Message Semantics	251
	4.21.4.1.2.1	PPS Exception Management Option	251
	4.22	Intentionally Left Blank.....	253
525	4.23	Print Request with Presentation LUT [RAD-23].....	254
	4.23.1	Scope	254
	4.23.2	Use Case Roles	254
	4.23.3	Referenced Standards	255
	4.23.4	Interaction Diagram.....	255
530	4.23.4.1	DICOM Film Session N-CREATE.....	255
	4.23.4.1.1	Trigger Events.....	256
	4.23.4.1.2	Message Semantics	256
	4.23.4.1.3	Expected Actions	256
	4.23.4.2	DICOM Presentation LUT N-CREATE.....	256
535	4.23.4.2.1	Trigger Events.....	256
	4.23.4.2.2	Message Semantics	256
	4.23.4.2.3	Expected Actions	257
	4.23.4.2.4	User Specifiable Lighting Condition Option	257
	4.23.4.3	DICOM Film Box N-CREATE	257
540	4.23.4.3.1	Trigger Events.....	257
	4.23.4.3.2	Message Semantics	257
	4.23.4.3.3	Expected Actions	258
	4.23.4.4	DICOM Image Box N-SET	258
	4.23.4.4.1	Trigger Events.....	258
545	4.23.4.4.2	Message Semantics	258
	4.23.4.4.3	Expected Actions	258
	4.23.4.5	DICOM Film Box N-ACTION.....	259
	4.23.4.5.1	Trigger Events.....	259
	4.23.4.5.2	Message Semantics	259
550	4.23.4.5.3	Expected Actions	259
	4.23.4.6	DICOM Film Session N-ACTION	259
	4.23.4.6.1	Trigger Events.....	259
	4.23.4.6.2	Message Semantics	259
	4.23.4.6.3	Expected Actions	259

555	4.23.4.7	Print Status (N-EVENT-REPORT)	260
	4.23.4.7.1	Trigger Events.....	260
	4.23.4.7.2	Message Semantics	260
	4.23.4.7.3	Expected Actions	260
	4.23.4.8	Mammography Image and Digital Breast Tomosynthesis Profile	260
560	4.24	Report Submission [RAD-24].....	263
	4.24.1	Scope	263
	4.24.2	Use Case Roles	263
	4.24.3	Referenced Standards	263
	4.24.4	Interaction Diagram.....	264
565	4.24.4.1	Report Creation.....	264
	4.24.4.1.1	Trigger Events.....	264
	4.24.4.1.2	Invocation Semantics	264
	4.24.4.1.2.1	Coded Entries.....	264
	4.24.4.1.2.2	Retrieve AE Title.....	265
570	4.24.4.1.2.3	Study Identification and Identical Documents Sequence	265
	4.24.4.1.3	Expected Actions	265
	4.24.4.2	Report Submission.....	265
	4.24.4.2.1	Trigger Events.....	265
	4.24.4.2.2	Message Semantics	266
575	4.24.4.2.3	Expected Actions	266
	4.25	Report Issuing [RAD-25].....	267
	4.25.1	Scope	267
	4.25.2	Use Case Roles	267
	4.25.3	Referenced Standards	268
580	4.25.4	Interaction Diagram.....	268
	4.25.4.1	Report Issuing (Step 1)	268
	4.25.4.1.1	Trigger Events.....	268
	4.25.4.1.2	Message Semantics	268
	4.25.4.1.3	Expected Actions	269
585	4.25.4.2	Report Modification.....	269
	4.25.4.2.1	Trigger Events.....	269
	4.25.4.2.2	Invocation Semantics	269
	4.25.4.2.2.1	Retrieve AE Title.....	270
	4.25.4.2.2.2	Study Identification and Identical Documents Sequence	271
590	4.25.4.2.3	Expected Actions	272
	4.25.4.3	Report Issuing (Step 2)	272
	4.25.4.3.1	Trigger Events.....	272
	4.25.4.3.2	Message Semantics	273
	4.25.4.3.3	Expected Actions	273
595	4.26	Query Reports [RAD-26].....	274
	4.26.1	Scope	274
	4.26.2	Use Case Roles	274
	4.26.3	Referenced Standards	274

	4.26.4	Interaction Diagram.....	275
600	4.26.4.1	Query Reports.....	275
	4.26.4.1.1	Trigger Events.....	275
	4.26.4.1.2	Message Semantics.....	275
	4.26.4.1.3	Expected Actions.....	277
	4.27	Retrieve Reports [RAD-27].....	278
605	4.27.1	Scope.....	278
	4.27.2	Use Case Roles.....	278
	4.27.3	Referenced Standards.....	279
	4.27.4	Interaction Diagram.....	279
	4.27.4.1	Retrieve Reports.....	280
610	4.27.4.1.1	Trigger Events.....	280
	4.27.4.1.2	Message Semantics.....	281
	4.27.4.1.3	Expected Actions.....	281
	4.27.4.2	View Reports.....	281
	4.27.4.2.1	Trigger Events.....	281
615	4.27.4.2.2	Invocation Semantics.....	281
	4.27.4.2.2.1	Retrieve AE Title.....	282
	4.27.4.2.3	Expected Actions.....	282
	4.28	Structured Report Export [RAD-27].....	283
	4.28.1	Scope.....	283
620	4.28.2	Use Case Roles.....	283
	4.28.3	Interaction Diagram.....	284
	4.28.3.1	Structured Report Export.....	284
	4.28.3.1.1	Trigger Events.....	284
	4.28.3.1.2	Message Semantics.....	284
625	4.28.4	DICOM SR to Structured Report Export Mapping.....	286
	4.28.5	Expected Actions.....	289
	4.29	Key Image Note Stored [RAD-29].....	290
	4.29.1	Scope.....	290
	4.29.2	Use Case Roles.....	290
630	4.29.3	Referenced Standards.....	290
	4.29.4	Interaction Diagram.....	291
	4.29.4.1	Key Image Note Stored.....	291
	4.29.4.1.1	Trigger Events.....	291
	4.29.4.1.2	Message Semantics.....	291
635	4.29.4.1.3	Expected Actions.....	291
	4.30	Query Key Image Notes [RAD-30].....	292
	4.30.1	Scope.....	292
	4.30.2	Use Case Roles.....	292
	4.30.3	Referenced Standards.....	292
640	4.30.4	Interaction Diagram.....	293
	4.30.4.1	Query Key Image Notes.....	293
	4.30.4.1.1	Trigger Events.....	293

	4.30.4.1.2 Message Semantics	293
	4.30.4.1.3 Expected Actions	294
645	4.31 Retrieve Key Image Notes [RAD-31].....	295
	4.31.1 Scope	295
	4.31.2 Use Case Roles	295
	4.31.3 Referenced Standards	295
	4.31.4 Interaction Diagram.....	296
650	4.31.4.1 Retrieve Key Image Notes	296
	4.31.4.1.1 Trigger Events.....	296
	4.31.4.1.2 Message Semantics	297
	4.31.4.1.3 Expected Actions	297
	4.31.4.2 Render Key Image Notes	297
655	4.31.4.2.1 Trigger Events.....	297
	4.31.4.2.2 Invocation Semantics	297
	4.31.4.2.2.1 Retrieve AE Title.....	297
	4.31.4.2.3 Expected Actions	298
660	4.31.4.2.3.1 Presentation of rejected or incorrect images in Mammography Acquisition Workflow	298
	4.31.4.2.3.2 Presentation of rejected or incorrect images in Imaging Object Change Management	298
	Appendix A: Attribute Consistency between Modality Worklist, Composite IODs, Evidence Documents, KIN and Modality Performed Procedure Step.....	299
665	A.1:Image Acquisition Integration-critical Attributes	299
	A.2:Evidence Documents Integration - Critical Attributes.....	314
	A.3:Context-critical Attributes	316
	A.4:Consistency Data Model	316
	A.5: Imported Object Integration – Critical Attributes.....	318
670	Appendix B: HL7 Order Mapping to DICOM MWL.....	327
	Appendix C: Departmental Access to Non-Radiology Information.....	338
	C.1: Scope.....	338
	C.2: Query Protocol	338
	C.3: External Report Content	340
675	Appendix D: Clarification of Patient Identifiers for Merge Cases.....	341
	D.1: Introduction.....	341
	D.2: Administrative Process Flow (RAD TF-1: 3.3.1).....	342
	D.3: Patient Merge (RAD TF-1: 3.3.2).....	342
	D.4: Trauma Cases 1 and 2 (RAD TF-1: 4.3).....	343
680	D.5: Trauma Case 3 (RAD TF-1: 4.3)	343
	D.6: Trauma Case 4 (RAD TF-1: 4.3)	344
	D.7: Trauma Case 5 (RAD TF-1: 4.3)	345
	Appendix E: HL7 Version 2.3.1 Message Field Replaced with HL7 Version 2.5.1 Summary 346	
685	E.1: RAD-1 Patient Registration/RAD-12 Patient Update.....	346
	E.2: RAD-2 Place Order Management/RAD-3 Filler Order Management	346

E.3: RAD-4 Procedure Scheduled/RAD-13 Procedure Update 347
GLOSSARY 348

690

1 Introduction

695 Integrating the Healthcare Enterprise (IHE) is an initiative that promotes the use of standards to achieve interoperability of health information technology (HIT) systems and effective use of electronic health records (EHRs). IHE provides a forum for volunteer committees of care providers, HIT experts and other stakeholders in several clinical and operational domains to reach consensus on standards-based solutions to critical interoperability issues. IHE publishes the implementation guides they produce (called *IHE profiles*), first to gather public comment and then for trial implementation by HIT vendors and other system developers.

700 IHE provides a process for developers to test their implementations of IHE profiles, including regular testing events called Connectathons. After a committee determines that a profile has undergone sufficient successful testing and deployment in real-world care settings, it is incorporated in the appropriate IHE Technical Framework, of which the present document is a volume. The Technical Frameworks provide a unique resource for developers and users of HIT systems: a set of proven, standards-based solutions to address common interoperability issues and support the convenient and secure use of EHRs.

705 Purchasers can specify conformance with appropriate IHE profiles as a requirement in requests for proposal. Vendors who have successfully implemented IHE profiles in their products can publish conformance statements (called IHE Integration Statements) in the IHE Product Registry (<http://product-registry.ihe.net>).

710 The current versions of this and all IHE Technical Framework documents are available at http://www.ihe.net/Technical_Frameworks/. Comments may be submitted at http://www.ihe.net/Radiology_Public_Comments.

715 IHE domain committees are responsible for developing and publishing Technical Framework documents. This document is published by the IHE Radiology committees. Information on the activities of this domain, including its committee rosters and how to participate, is available at <http://wiki.ihe.net/index.php?title=Domains>.

General information about IHE, including its governance structure, sponsorship, member organizations and work process, is available at www.ihe.net.

1.1 Overview of Technical Framework

720 This document, the IHE Technical Framework, defines specific implementations of established standards to achieve integration goals that promote appropriate sharing of medical information to support optimal patient care. It is expanded annually, after a period of public review, and maintained regularly through the identification and correction of errata. The latest version of the document is always available via the Internet at http://www.ihe.net/Technical_Frameworks.

725 The IHE Technical Framework defines a subset of the functional components of the healthcare enterprise, called IHE actors, and specifies their interactions in terms of a set of coordinated, standards-based transactions. It defines this body of transactions in progressively greater depth. RAD TF-1 provides a high-level view of IHE functionality, showing the transactions organized

730 into functional units called Integration Profiles that highlight their capacity to address specific clinical needs. Volume 2 provides detailed technical descriptions of IHE transactions RAD-1 - RAD-31 along with a description of the conventions used to define IHE transactions and an overview of the concepts of IHE actors and transactions. Volume 3 provides detailed technical descriptions of IHE transactions RAD-32 - RAD-75.

1.2 Overview of Volume 2

735 Section 2 presents the conventions used in this volume to define the transactions implemented under IHE.

Section 3 provides an overview of the concepts of IHE actors and transactions used in IHE to define the functional components of a distributed healthcare environment.

740 Section 4 defines transactions RAD-1 to RAD-31 in detail, specifying the roles for each actor, the standards employed, the information exchanged, and in some cases, implementation options for the transaction.

745 The appendices following the main body of this volume provide clarification of technical details of the IHE data model and transactions. The final section of the volume is a glossary of terms and acronyms used in the IHE Technical Framework, including those from relevant standards (currently HL7^{®1} and DICOM^{®2}).

1.3 Audience

The intended audience of this document is:

- Technical staff of vendors planning to participate in the IHE initiative
- IT departments of healthcare institutions
- 750 • Experts involved in standards development
- Anyone interested in the technical aspects of integrating healthcare information systems

1.4 Relationship to Standards

755 The IHE Technical Framework identifies functional components of a distributed healthcare environment solely from the point of view of their interactions in the healthcare enterprise. At its current level of development, it defines a coordinated set of transactions based on the HL7 and DICOM standards. As the scope of the IHE initiative expands, transactions based on other standards will be included as required.

In some cases, IHE recommends selection of specific options supported by these standards; however, IHE does not introduce technical choices that contradict conformance to these

¹ HL7 is the registered trademark of Health Level Seven International.

² DICOM is the registered trademark of the National Electrical Manufacturers Association for its standards publications relating to digital communications of medical information.

760 standards. If errors in or extensions to existing standards are identified, IHE’s policy is to submit
those to the appropriate standards bodies for resolution within their conformance and standards
evolution strategy. IHE is therefore an implementation framework, not a standard. Referencing
IHE as a standard and claiming conformance to IHE are both inappropriate. Conformance claims
765 state that the products they describe are “implemented in accordance with the IHE Technical
Framework”. See RAD TF-1: Appendix D for the suggested form of such statements.

IHE encourages implementers to ensure that products implemented in accordance with the IHE
Technical Framework also meet the full requirements of the standards underlying IHE, allowing
the products to interact, although possibly at a lower level of integration, with products that have
770 been implemented in compliance with the standards but that may not meet the IHE requirements.

1.5 Relationship to Real-world Architectures

The actors and transactions described in the IHE Technical Framework are abstractions of the
real-world healthcare information system environment. While some of the transactions are
traditionally performed by specific product categories (e.g., HIS, RIS, PACS, or modalities), the
775 IHE Technical Framework intentionally avoids associating functions or actors with such product
categories. For each actor, the IHE Technical Framework defines only those functions associated
with integrating information systems. The IHE definition of an actor should therefore not be
taken as the complete definition of any product that might implement it, nor should the
framework itself be taken as the complete definition of a healthcare information system
780 architecture.

The reason for defining actors and transactions is to provide a basis for defining the interactions
among functional components of the healthcare information system environment. In situations
where a single physical product implements multiple functions, only the interfaces between the
product and external functions in the environment are considered to be significant by the IHE
785 initiative. Therefore, the IHE initiative takes no position on the relative merits of an integrated
environment based on a single, all-encompassing information system versus one based on
multiple systems that together achieve the same end. To illustrate most dramatically the
possibilities of the IHE Technical Framework, however, the IHE demonstrations emphasize the
integration of multiple vendors’ systems based on the IHE Technical Framework.

790 1.6 Comments

HIMSS and RSNA welcome comments on this document and the IHE initiative. They should be
submitted at http://www.ihe.net/Radiology_Public_Comments or to:

Chris Carr
IHE Secretary
795 820 Jorie Boulevard
Oak Brook, IL 60523
Email: radiology@ihe.net

1.7 Copyright Permission

800 Health Level Seven, Inc. has granted permission to the IHE to reproduce tables from the HL7 standard. The HL7 tables in this document are copyrighted by Health Level Seven, Inc. All rights reserved.

The National Electrical Manufacturers Association (NEMA) has granted permission to the IHE to incorporate portions of the DICOM standard.

Material drawn from these documents is credited where used.

805 **2 Conventions**

This document has adopted the following conventions for representing the framework concepts and specifying how the standards upon which the IHE Technical Framework is based shall be applied.

2.1 The Generic IHE Transaction Model

810 Transaction descriptions are provided in Section 4. In each transaction description, the actors, the roles they play, and the transactions between them are presented as use cases.

The generic IHE transaction description includes the following components:

- Scope: a brief description of the transaction.
- Use case roles: textual definitions of the actors and their roles, with a simple diagram relating them, e.g.,:

815

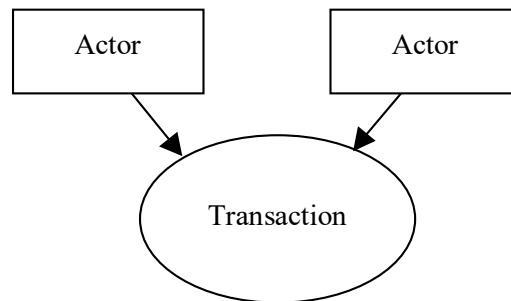

- *Referenced Standards*: the standards (stating the specific parts, chapters or sections thereof) to be used for the transaction.
- *Interaction Diagram*: a graphical depiction of the actors and transactions, with related processing within an actor shown as a rectangle and time progressing downward, similar to:

820

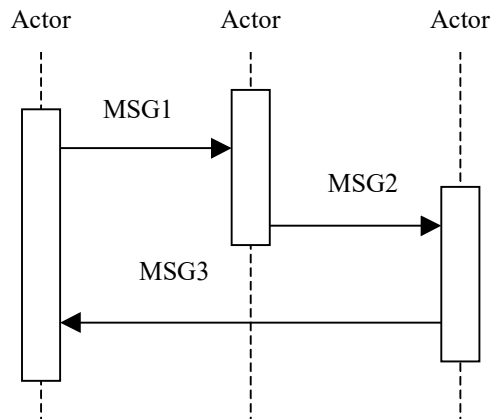

825 The interaction diagrams used in the IHE Technical Framework are modeled after those described in Grady Booch, James Rumbaugh, and Ivar Jacobson, *The Unified Modeling Language User Guide*, ISBN 0-201-57168-4. Simple acknowledgment messages are omitted from the diagrams for brevity.

- 830 • *Message definitions*: descriptions of each message involved in the transaction, the events that trigger the message, its semantics, and the actions that the message triggers in the receiver.

2.2 DICOM Usage Conventions

For some DICOM transactions described in this document, IHE has strengthened the requirements on the use of selected Type 2 and Type 3 attributes. These situations are explicitly documented in Section 4 and in the appendices.

835 IHE specifically emphasizes that DICOM Type 2 attributes (for instance, Patient Name, Patient ID) shall be transmitted with zero length if the source system does not possess valid values for such attributes; in other words, the source system shall not assign default values to such attributes. The receiving system must be able to handle zero-length values for such attributes.

840 IHE has defined requirements related to the support for and use of attributes in DICOM storage transactions by both Service Class Users (SCUs) and Service Class Providers (SCPs):

- O The attribute or its value is optional, i.e., in DICOM it is Type 2 or 3.
- R The attribute is required, and is not an IHE extension of the DICOM requirements; i.e., it is already Type 1 in DICOM, but additional constraints are placed by IHE, for example on the value set that may be used for the attribute.
- 845 • R+ The Requirement is an IHE extension of the DICOM requirements, and the attribute shall be present with a value in images created by the Acquisition Modality, i.e., is Type 1, whereas the DICOM requirement may be Type 2 or 3.

- 850
- RC+ The Requirement is an IHE extension of the DICOM requirements, and the attribute shall be present with a value in images created by the Acquisition Modality when the condition is satisfied, i.e., is Type 1C, whereas the DICOM requirement may be Type 2 or 3.

IHE has also defined requirements related to the support for and use of matching and return keys in DICOM queries by both Service Class Users (SCUs) and Service Class Providers (SCPs).

- 855
- Matching keys are used to select instances for inclusion in the response by the query SCP to the SCU, whereas return keys only return specific data and are not used for matching.

- Required matching key SCU:

860

A key that the Query SCU shall have the ability to offer to its user as a selection criterion. The definition of the means offered to the user of the Query SCU to trigger the sending of a matching key in the Query request is beyond the scope of IHE (e.g., enter a value, select an entry). A Query SCU shall include as a Matching Key in each C-FIND request all attributes specified as R or R+ for which the user provided a value. If the user does not provide a value, the Query SCU shall send the attribute zero-length (i.e., as a Return Key).

- 865
- Required matching key SCP:

An IHE required matching key is processed by the Query SCP just as if it were a DICOM-required matching key. In most cases, IHE-required matching keys are also DICOM-required matching keys.

- Required return key SCU:

870

A key that the Query SCU requests from the Query SCP and receives in the query responses. The definition of the means offered to the user of the Query SCU to request a return key (e.g., by default, check a box) and to make it visible to the user is beyond the scope of IHE. A Query SCU shall include as Return Keys in each C-FIND request all attributes specified as R, R+, R*, or R+*. A Query SCU shall display for the user the returned value of all attributes specified as R or R+ in the normal user interface.

875

- Required return key SCP:

- IHE-required return keys specified within DICOM as type 1 or type 2 return keys are processed according to their DICOM type. IHE-required return keys specified within DICOM as type 3 will be processed as if they were type 2.

880

Query Key Requirement Tables in the framework use the following legend to specify requirements for SCUs and SCPs:

- R Required
- O Optional

The following modifiers are also used:

- 885
- R+ The Requirement is an IHE extension of the DICOM requirements

- R* The attribute is not required to be displayed
- R+* The Requirement is an IHE extension of the DICOM requirements, but the attribute is NOT required to be displayed

890 Table 2.2-1 provides an example table defining matching and return keys. Note that sequence attributes are used as a structuring header in these matching and return key tables, and requirements are given for individual sequence items.

Table 2.2-1: Images Query Matching and Return Keys

Attributes Name	Tag	Query Keys Matching		Query Keys Return		Notes
		SCU	SCP	SCU	SCP	
Scheduled Human Performers Sequence	(0040,4034)					
>Human Performer Code Sequence	(0040,4009)					
>>Code Value	(0008,0100)	R+	R	R+*	R	
>>Coding Scheme Designator	(0008,0102)	R+	R	R+*	R	
>>Code Meaning	(0008,0104)	-	-	R+	R	Query Keys Matching SCU or SCP do not use the Code Meaning values (“-“).
>Human Performer's Name	(0040,4037)	R+	R+	R+	R+	
>Human Performer's Organization	(0040,4036)	O	O	O	R+	
Input Information Sequence	(0040,4021)					
>Study Instance UID	(0020,000D)	O	O	R+*	R	
...

2.3 HL7 Profiling Conventions

895 The HL7 tables included in this document have been modified from the corresponding HL7 standard documents. Such a modification is called a profile using static definitions as described for HL7 constrainable message profiles; refer to HL7 v2.5.1, Chapter 2, Section 2.12.6.

The static definition of an IHE-profiled message is represented within tables in the Technical Framework. The message level table represents the IHE-profiled message structure with its list

900 of usable segments. The segment level table represents the IHE-profiled content of one segment with its usable fields.

2.3.1 Static definition – Segment level and Data Type level

The Segment table and the Data Type table each contain 8 columns (HL7 v2.3.1 messages use only 7 columns) as described below:

- **SEQ:** Position (sequence) of the field within the segment.
- 905 • **LEN:** Maximum length of the field.
Since version 2.5, the HL7 standard also defines the maximum length of each component with a field. IHE profiled HL7 messages shall conform to the HL7 standard if not otherwise stated in this Technical Framework.
- **DT:** Field Data Type
- 910 • **Usage:** Usage of the field (column noted as **OPT** in HL7 v2.3.1 message static definition.)
The coded values used in this column are:
 - R:** Required: A compliant sending application shall populate all "R" elements with a non-empty value. A compliant receiving application may ignore the information conveyed by required elements. A compliant receiving application shall not raise an error due to the presence of a required element, but may raise an error due to the absence of a required element.
 - 915 **R+:** Required as IHE extension: This is a field optional in the original HL7 standard but required in the IHE-profiled messages. Only HL7 v2.3.1 messages use this notation to indicate the difference between OPT in the IHE profiles and in the base HL7 standard.
 - 920 **RE:** Required but may be empty. (“R2” in HL7 v2.3.1 messages)
The element may be missing from the message, but shall be sent by the sending application if there is relevant data. A conformant sending application shall be capable of providing all "RE" elements. If the conformant sending application knows a value for the element, then it shall send that value. If the conformant sending application does not know a value, then that element may be omitted. Receiving applications may ignore data contained in the element, but shall be able to successfully process the message if the element is omitted (no error message should be generated if the element is missing).
 - 925 **O:** Optional. The usage for this field within the message is not defined. The sending application may choose to populate the field; the receiving application may choose to ignore the field.
 - 930 **C:** Conditional. This usage has an associated condition predicate. (See HL7 v2.5.1, Chapter 2, Section 2.12.6.6, "Condition Predicate".)
 - 935

If the predicate is satisfied: A compliant sending application shall populate the element. A compliant receiving application may ignore data in the element. It may raise an error if the element is not present.

940

If the predicate is NOT satisfied: A compliant sending application shall NOT populate the element. A compliant receiving application shall NOT raise an error if the condition predicate is false and the element is not present, though it may raise an error if the element IS present.

945

The condition predicate is not explicitly defined when it depends on functional characteristics of the system implementing the transaction and it does not affect data consistency.

CE: Conditional but may be empty. This usage has an associated condition predicate. (See HL7 Version 2.5, Chapter 2, Section 2.12.6.6, "Condition Predicate".)

950

If the conforming sending application knows the required values for the element, then the application must populate the element. If the conforming sending application does not know the values required for this element, then the element shall be omitted.

955

The conforming sending application must be capable of populating the element (when the predicate is true) for all 'CE' elements. If the element is present, the conformant receiving application may ignore the values of that element. If the element is not present, the conformant receiving application shall not raise an error due to the presence or absence of the element.

If the predicate is NOT satisfied: The conformant sending application shall not populate the element. The conformant receiving application may raise an application error if the element is present.

960

X: Not supported. For conformant sending applications, the element will not be sent. Conformant receiving applications may ignore the element if it is sent, or may raise an application error.

- **Cardinality:** Minimum and maximum number of occurrences for the field in the context of this Transaction.

- This column is not used in IHE-profiled HL7 v2.3.1 message.

965

- **TBL#:** Table reference (for fields using a set of defined values)

- **ITEM#:** HL7 unique reference for this field

- **Element Name:** Name of the field in a Segment table. / **Component Name:** Name of a subfield in a Data Type table.

970

Table 2.3-1 provides a sample profile for an imaginary HL7 segment. Tables for actual segments are copied from the corresponding HL7 standard versions with modifications made only to the OPT (Usage) column.

Table 2.3-1: Sample HL7 Profile

SEQ	LEN	DT	OPT	TBL#	ITEM #	ELEMENT NAME
1	1	ST	R		xx001	Element 1
2	4	ST	O		xx002	Element 2
3	180	HD	R2		xx003	Element 3
4	180	HD	C		xx004	Element 4
5	180	HD	O		xx005	Element 5
6	180	HD	R		xx006	Element 6

Note: This sample table is made for HL7 v2.3.1 message definition in this Technical Framework. For HL7 v2.5.1, one more column "Cardinality" will be added between columns OPT and TBL#.

975

The lengths of the fields specified in the **LEN** column of profiling tables shall be interpreted in accordance with HL7 standard, where it indicates the calculated length of the single occurrence of the field based on the expected maximum lengths of its individual components.

980

As such, IHE requires that the receiving actors are able to properly process the fields where each occurrence is up to the maximum length specified in the HL7 profiling tables. Sending actors shall be able to generate messages where single occurrences of fields do not exceed maximum lengths specified in the profiling tables. Both receiving and sending actors shall take into account the mapping of values between HL7 and DICOM (see Section 2.5) so that values of components that are mapped into DICOM do not exceed length limitations of that standard.

985

Handling of fields with single occurrence longer than maximum length is out of scope of IHE specifications.

2.3.2 Static definition - Message level

The message table representing the static definition contains 5 columns (HL7 v2.3.1 messages use only 3 columns) as described below:

990

- **Segment:** gives the segment name, and places the segment within the hierarchy of the message structure designed by HL7.
- The beginning and end lines of a segment group (see HL7 v2.5.1, Chapter 2, Section 2.5.2 for definition) are designated in this column by --- (3 dashes). The square brackets and braces that designate optionality and repeatability are hidden.

995

- **Meaning:** Meaning of the segment as defined by HL7.
- **Usage:** Usage of the segment. Same coded values used in the segment level: R, RE, O, C, CE, and X (see Section 2.3.1).

1000

- This column is not used in HL7 v2.3.1 messages.
- **Cardinality:** Minimum and maximum number of occurrences authorized for this segment in the context of the IHE-profiled HL7 message.
- This column is not used in HL7 v2.3.1 messages.

HL7 chapter: Reference of the HL7 standard document chapter that describes this segment.

2.4 HL7 Implementation Notes

1005 This section describes the guidance and requirements for the general aspects of implementing IHE-profiled HL7 messages, e.g., message control, acknowledgement, version policy and network associations. Section 2.4.1 lists common requirements for HL7 messages of all versions supported in this Technical Framework, followed by specific requirements for each supported version in individual sections starting from Section 2.4.2.

2.4.1 Common HL7 Message Implementation Requirements

1010 Systems implementing IHE-profiled HL7 messages shall do so according to the HL7 Standard unless otherwise specified in Section 2.4 or the specific transaction.

2.4.1.1 Network Guidelines

1015 The HL7 standards do not define a network communications protocol. The HL7 v2.1 standard defines lower layer protocols in an appendix. These definitions were moved to the Implementation Guide in 2.2 and subsequent versions, but are not HL7 requirements. The IHE Framework makes these recommendations:

1. Applications shall use the Minimal Lower Layer Protocol defined in Appendix C of the HL7 Implementation Guide.
- 1020 2. An application that wants to send a message (initiate a transaction) will initiate a network connection to start the transaction. The receiver application will respond with an acknowledgement or response to query but will not initiate new transactions on this network connection.

2.4.1.2 Acknowledgement Mode

1025 Applications that receive HL7 messages shall send acknowledgments using the HL7 Original Mode (versus Enhanced Acknowledgment Mode).

2.4.1.3 HL7 Versioning

The selection of a particular version of HL7 for any given HL7 based transaction within the Technical Framework is based upon a number of factors. These include:

- Whether the version of HL7 provides the functionality needed for the transaction.
- 1030 • How widely the version of HL7 is supported at the time of specification

Since the transactions are self-contained communications, the implementation of each HL7 transaction may use a different version of HL7.

1035 An application implementing an IHE transaction with HL7 messages must comply with the message structure and contents defined by the specified version(s) of the HL7 standard as defined in the transaction technical specification, as well as in this section. It is acceptable if the HL7 standard version value (MSH-12) in a conformant message is higher than that specified in the transaction specification of the Technical Framework as long as the message structure and contents meet the requirements of the specification.

2.4.1.4 Empty Field

1040 According to the HL7 standard, if the value of a field is not present, the receiver shall not change corresponding data in its database. However, if sender includes explicit NULL value (i.e., two double-quotes “”), it shall cause removal of any values for that field in the receiver’s database.

2.4.1.5 Z-Segment

1045 IHE prohibits sending Z-segments unless one is defined for a transaction in the IHE Technical Framework.

2.4.2 HL7 v2.3.1 Message Implementation Requirements

2.4.2.1 Acknowledgement Message

1050 The IHE Technical Framework provides for each HL7 message to be acknowledged by the HL7 ACK message sent by the receiver of an HL7 message to its sender. The segments of the ACK message listed below are required, and their detailed descriptions are provided in the following subsections. The ERR segment is optional and may be included if the *MSA-1 Acknowledgment Code* field identifies an error condition.

Table 2.4-1: Common ACK Message static definition

Segment	Meaning	HL7 chapter
MSH	Message Header	2
MSA	Message Acknowledgement	2
[ERR]	Error	2

Adapted from the HL7 Standard, version 2.3.1

1055 **2.4.2.2 Message Control**

The MSH (message header) segment contains control information set in the beginning of each message sent.

Table 2.4-2: IHE Profile - MSH segment

SEQ	LEN	DT	OPT	TBL#	ITEM #	ELEMENT NAME
1	1	ST	R		00001	Field Separator
2	4	ST	R		00002	Encoding Characters
3	180	HD	R+		00003	Sending Application
4	180	HD	R+		00004	Sending Facility
5	180	HD	R+		00005	Receiving Application
6	180	HD	R+		00006	Receiving Facility
7	26	TS	R		00007	Date/Time Of Message
8	40	ST	O		00008	Security
9	13	CM	R	0076/ 0003	00009	Message Type

SEQ	LEN	DT	OPT	TBL#	ITEM #	ELEMENT NAME
10	20	ST	R		00010	Message Control ID
11	3	PT	R		00011	Processing ID
12	60	VID	R	0104	00012	Version ID
13	15	NM	O		00013	Sequence Number
14	180	ST	O		00014	Continuation Pointer
15	2	ID	O	0155	00015	Accept Acknowledgment Type
16	2	ID	O	0155	00016	Application Acknowledgment Type
17	3	ID	O	0399	00017	Country Code
18	16	ID	C	0211	00692	Character Set
19	250	CE	O		00693	Principal Language Of Message
20	20	ID	O	0356	01317	Alternate Character Set Handling Scheme

Adapted from the HL7 Standard, version 2.3.1

1060 IHE requires that applications support HL7-recommended values for the fields *MSH-1-Field Separator* and *MSH-2-Encoding Characters*.

Field *MSH-18-Character Set* shall only be valued if the message utilizes character sets other than ISO IR-6, also known as ASCII.

1065 Implementations supporting sequence number protocol (and using the field *MSH-13-Sequence Number*) shall be configurable to allow them to perform transactions without such protocol.

2.4.2.3 Acknowledgement Modes

This segment contains information sent while acknowledging another message.

Table 2.4-3: IHE Profile - MSA segment

SEQ	LEN	DT	OPT	TBL#	ITEM#	ELEMENT NAME
1	2	ID	R	0008	00018	Acknowledgment Code
2	20	ST	R		00010	Message Control ID
3	80	ST	O		00020	Text Message
4	15	NM	O		00021	Expected Sequence Number
5	1	ID	O	0102	00022	Delayed Acknowledgment Type
6	100	CE	O		00023	Error Condition

Adapted from the HL7 standard, version 2.3.1

1070 Field *MSA-2 Message Control ID* shall contain the Message ID from the *MSH-10 Message Control ID* of the incoming message for which this acknowledgement is sent.

2.4.2.4 ERR – Error Segment

This segment contains information sent while field MSA-1 (acknowledgement code) identifies an error condition.

1075

Table 2.4-4: IHE Profile - ERR segment

SEQ	LEN	DT	OPT	TBL#	ITEM#	ELEMENT NAME
1	80	ID	R		00024	Error code and location

*Adapted from the HL7 standard, version 2.3.1***2.4.3 HL7 v2.4 Message Implementation Requirements**

HL7 v2.4 is fully backward compatible with HL7 v2.3. Refer to Section 2.4.2 when implementing HL7 v2.4.

1080

2.4.4 HL7 v2.5 Message Implementation Requirements**2.4.4.1 Acknowledgement Message**

1085

The IHE Technical Framework provides for each HL7 message to be acknowledged by the HL7 ACK message sent by the receiver of an HL7 message to its sender. The segments of the ACK message listed below are required, and their detailed descriptions are provided in the following subsections. The ERR segment is optional and may be included if the *MSA-1 Acknowledgment Code* field identifies an error condition.

Table 2.4-5: Common ACK Message static definition

Segment	Meaning	Usage	Card.	HL7 chapter
MSH	Message Header	R	[1..1]	2
MSA	Message Acknowledgement	R	[1..1]	2
ERR	Error	C	[0..*]	2

*Adapted from the HL7 Standard, version 2.5.1***2.4.4.2 Message Control**

1090

The MSH (message header) segment contains control information set in the beginning of each message sent.

Table 2.4-6: IHE Profile - MSH segment

SEQ	LEN	DT	Usage	Card.	TBL #	ITEM#	Element name
1	1	SI	R	[1..1]		00001	Field Separator
2	4	ST	R	[1..1]		00002	Encoding Characters
3	227	HD	R	[1..1]		00003	Sending Application
4	227	HD	R	[1..1]		00004	Sending Facility
5	227	HD	R	[1..1]		00005	Receiving Application
6	227	HD	R	[1..1]		00006	Receiving Facility
7	26	TS	R	[1..1]		00007	Date/Time of Message
8	40	ST	X	[0..0]		00008	Security

SEQ	LE N	DT	Usage	Card.	TBL #	ITEM#	Element name
9	15	MSG	R	[1..1]		00009	Message Type
10	20	ST	R	[1..1]		00010	Message Control Id
11	3	PT	R	[1..1]		00011	Processing Id
12	60	VID	R	[1..1]		00012	Version ID
13	15	NM	O	[0..1]		00013	Sequence Number
14	180	ST	X	[0..0]		00014	Continuation Pointer
15	2	ID	O	[0..0]	0155	00015	Accept Acknowledgement Type
16	2	ID	O	[0..0]	0155	00016	Application Acknowledgement Type
17	3	ID	RE	[1..1]	0399	00017	Country Code
18	16	ID	C	[0..1]	0211	00692	Character Set
19	250	CE	RE	[1..1]		00693	Principal Language of Message
20	20	ID	X	[0..0]	0356	01317	Alternate Character Set Handling Scheme
21	427	EI	RE	[0..*]		01598	Message Profile Identifier

Adapted from the HL7 standard, version 2.5.1

1095 **MSH-1 Field Separator**, required: IHE requires that applications support any ASCII value for field separator as specified in the HL7 standard. The value recommended by HL7 is “|” (ASCII 124).

1100 **MSH-2 Encoding Characters**, required: This field contains the four characters in the following order: the component separator, repetition separator, escape character, and subcomponent separator. IHE requires that applications support any ASCII values for encoding characters as specified in the HL7 standard. The values recommended by HL7 are “^~\&” (ASCII 94, 126, 92, and 38, respectively).

MSH-9 Message Type (MSG), required:

Components: <Message Code (ID)> ^ <Trigger Event (ID)> ^ <Message Structure (ID)>

1105 Definition: This field contains the message type, trigger event, and the message structure ID for the message. All three components are required.

MSH-10 Message Control Id (ST), required:

1110 Definition: This field contains a number or other identifier that uniquely identifies the message in the context of exchange between trading partners. Each message should be given a unique identifier by the sending system. The receiving system will echo this ID back to the sending system in the Message Acknowledgment segment (MSA). The combination of this identifier and the name of the sending application (MSH-3) should be unique across the message exchange environment.

MSH-12 Version ID (VID), required:

1115 Components: <Version ID (ID)> ^ <Internationalization Code (CE)> ^ <International Version ID (CE)>

Definition: This field is matched by the receiving system to its supported version(s) to be sure the message will be interpreted correctly.

The first component SHALL be populated with the value "2.5.1" or higher, representing HL7 Version 2.5.1 or higher. See Section 2.4.1.3.

1120 **MSH-17 Country Code (ID)**, required if available.

Definition: This field contains the country of origin for the message. The values to be used are those of ISO 3166, using the 3-character alphabetic form. Refer to *HL7 Table 0399 - Country code*.

Examples of valid values:

- 1125 JPN = Japan
 USA = United States
 GBR = United Kingdom
 ITA = Italy
 FRA = France
1130 NLD = Netherlands.

MSH-18 Character Set (ID), conditional.

Definition: This field contains the character set for the entire message. Refer to *HL7 Table 0211 - Alternate character sets* for valid values.

Examples of valid values:

- 1135 ASCII: The printable 7-bit ASCII character set.
 8859/1: The printable characters from the ISO 8859/1 Character set used by Western Europe. This character set can still be used, but 8859/15 should be used by preference. This character set is the forward-compatible version of 8859/1 and includes new characters such as the Euro currency symbol.
1140 ISO IR87: Code for the Japanese Graphic Character set for information interchange (JIS X 0208-1990).
 UNICODE UTF-8: UCS Transformation Format, 8-bit form.

1145 **Condition predicate:** This field shall only be valued if the message uses a character set other than the 7-bit ASCII character set. Though the field is repeatable in HL7, IHE authorizes only one occurrence (i.e., one character set). The character set specified in this field is used for the encoding of all of the characters within the message.

MSH-19 Principal Language of Message (CE), required if available. Coded from ISO 639.

Examples:

- 1150 DE = German
 EN = English
 ES = Spanish

- 1155 JA = Japanese
 FR = French
 NL = Dutch
 IT = Italian

MSH-20 Alternate Character Set Handling Scheme (ID), not supported: Character set switching is not allowed HL7 transactions of the IHE Technical Frameworks.

MSH-21 Message Profile Identifier (EI), required if available.

- 1160 This field shall be valued in the messages for which a Message Profile has been officially registered with HL7. When multiple message profiles are listed in this field, they should be vendor specific and/or country specific message profiles constraining the official one.

2.4.4.3 Acknowledgement Modes

This segment contains information sent while acknowledging another message.

1165

Table 2.4-7: MSA - Message Acknowledgement

SEQ	LEN	DT	Usage	Card.	TBL #	ITEM#	Element name
1	2	ID	R	[1..1]	0008	00018	Acknowledgement code
2	20	ST	R	[1..1]		00010	Message Control Id
3	80	ST	X	[0..0]		00020	Text Message
4	15	NM	O	[0..1]		00021	Expected Sequence Number
5			X	[0..0]		00022	Delayed Acknowledgment Type
6	250	CE	X	[0..0]	0357	00023	Error Condition

Adapted from the HL7 standard, version 2.5.1

MSA-1 Acknowledgment Code (ID), required.

- 1170 In case that the receiving application does not recognize either the message type (MSH-9.1) or the trigger event (MSH-9.2) in a message, Field MSA-1 of the acknowledgement shall contain the value **AR** or **CR**.

MSA-2 Message Control ID (ST), required.

Definition: This field contains the message control ID from Field *MSH-10-Message Control ID* of the incoming message for which the acknowledgement is sent.

MSA-3 Text Message (ST), not supported. See Section 2.4.4.4 for the ERR segment.

- 1175 **MSA-6 Error Condition (CE)**, not supported. See Section 2.4.4.4 for the ERR segment.

2.4.4.4 ERR - Error segment

This segment is used to add error comments to acknowledgment messages.

Table 2.4-8: ERR – Error segment

SEQ	LE N	DT	Usage	Card.	TBL #	ITEM#	Element name
1	493	ELD	X	[0..0]		00024	Error Code and Location
2	18	ERL	RE	[0..*]		01812	Error Location
3	705	CWE	R	[1..1]	0357	01813	HL7 Error Code
4	2	ID	R	[1..1]	0516	01814	Severity
5	705	CWE	O	[0..1]	0533	01815	Application Error Code
6	80	ST	O	[0..10]		01816	Application Error Parameter
7	2048	TX	O	[0..1]		01817	Diagnostic Information
8	250	TX	O	[0..1]		01818	User Message
9	20	IS	O	[0..*]	0517	01819	Inform Person Indicator
10	705	CWE	O	[0..1]	0518	01820	Override Type
11	705	CWE	O	[0..*]	0519	01821	Override Reason Code
12	652	XTN	O	[0..*]		01822	Help Desk Contact Point

1180

Adapted from the HL7 standard, version 2.5.1

ERR-1 is deprecated since HL7 Version 2.5 (i.e., retained for backward compatibility only) and therefore not supported by IHE.

1185

ERR-2 is populated except when the error is not within an HL7 field, component or subcomponent. For example, if the receiver returns an acknowledgement containing *MSA-1-acknowledgement code* value **AR** or **CR** to indicate that the receiving application was unavailable, ERR-2 is not populated

ERR-3 HL7 Error Code (CWE) is required. It identifies the HL7 (communication) error code. Valid values are given by HL7 Table 0357:

1190

In case that the receiving application does not recognize either the message type (MSH-9.1) or the trigger event (MSH-9.2) in a message, the components of Field ERR-2 of the acknowledgement shall be populated as follows.

ERR-2.1: **MSH**

ERR-2.2: **1**

ERR-2.3: **9**

1195

ERR-2.4: **1**

ERR-2.5: **1** if an unrecognized message type

2 if an unrecognized trigger event

The components of Field ERR-3 of the acknowledgement shall be populated as follows.

ERR-3.1: **200** if an unrecognized message type

1200

201 if an unrecognized trigger event

ERR-3.2: **Unsupported message type** or
Unsupported trigger event as appropriate

ERR-3.3: **HL70357**

1205 **ERR-4 Severity (ID)** is required. It identifies the severity of an application error. Valid values are given by HL7 Table 0516.

2.5 HL7 and DICOM Mapping Considerations

1210 Field lengths are explicitly defined in the DICOM standard, but an HL7 element might consist of multiple components that do not have a defined maximum length. It is recognized that there are some HL7 component lengths that could be longer than the DICOM attribute lengths. Data values for mapped fields are required not to exceed the smaller of either the HL7 or the DICOM field length definitions. Systems supporting alternative character sets must take into account the number of bytes per character in such sets. All systems are required to support the DICOM Default Character Set (ISO-IR 6 or ASCII). In addition, other character sets may be supported. Maintaining consistency of data encoded using alternative character sets is outside of the scope of the IHE Technical Framework.

1215 Value Representations are not explicitly addressed. Attention shall be given to the mapping of the HL7 representation and the DICOM representation. Examples of these include Patient Name, dates and times.

2.6 Use of Coded Entities and Coding Schemes

1220 IHE does not produce, maintain or otherwise specify a coding scheme or other resource for controlled terminology (coded entities). Where applicable, coding schemes required by the HL7 and DICOM standards take precedence. In the cases where such resources are not explicitly identified by the standards, implementations may utilize any resource (including proprietary or local) provided any licensing/copyright requirements are satisfied.

1225

3 Framework Overview

The IHE Technical Framework is based on actors that interact through transactions.

Actors are information systems or components of information systems that produce, manage, or act on information associated with operational activities in the enterprise.

1230 Transactions are interactions between actors that transfer the required information through standards-based messages.

Specific sets of actors and transactions are specified in the Integration Profiles (see RAD TF-1: 3-16).

1235 **4 IHE Transactions**

This section defines each IHE transaction in detail, specifying the standards used, the information transferred, and the conditions under which the transaction is required or optional.

4.1 Patient Registration [RAD-1]

1240 This section corresponds to Transaction RAD-1 of the IHE Technical Framework. Transaction RAD-1 is used by the actors: ADT, Order Placer and Department System Scheduler/Order Filler.

4.1.1 Scope

1245 This transaction involves the patient information, including demographics, captured at the point of encounter. This may occur when the visit is scheduled, if that precedes patient arrival at the institution. This transaction is used for both in-patients (i.e., those who are assigned a bed at the facility) and outpatients (i.e., those who are not assigned a bed at the facility).

4.1.2 Use Case Roles

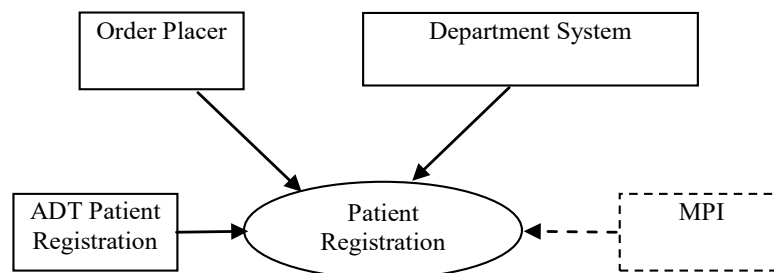

Actor: ADT

1250 **Role:** Adds and modifies patient demographic and encounter information.

Actor: Order Placer

Role: Receives patient and encounter information for use in order entry.

Actor: Department System

1255 **Role:** Receives and stores patient and encounter information for use in fulfilling orders by the Department System Scheduler.

Actor: MPI

Role: Receives patient and encounter information from multiple ADT systems. Maintains unique enterprise-wide identifier for a patient.

4.1.3 Referenced Standards

- 1260 HL7 2.3.1 Chapters 2, 3
 HL7 v2.5.1 Chapters 2, 3, 7, 15
 IHE ITI Technical Framework

4.1.4 Interaction Diagram

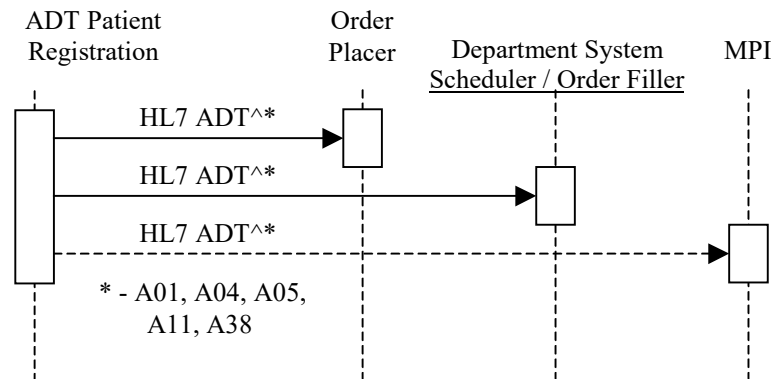

1265

Note: IHE Technical Framework currently does not support the use of a Master Patient Index, which would be required for synchronization of patient information between multiple ADT systems employed by a healthcare enterprise. It is expected the IHE initiative will include an MPI Actor in the future and that the Patient Registration Transaction between the ADT and MPI will be similar to the transaction between the ADT and Order Placer and Order Filler Actors.

1270

4.1.4.1 Patient Management – Admit/Register Patient

4.1.4.1.1 Trigger Events

The following events will trigger one of the Admit/Register messages:

- A01 – Admission of an in-patient into a facility
- 1275 • A04 – Registration of an outpatient for a visit of the facility
- A05 – Pre-admission of an in-patient (i.e., registration of patient information ahead of actual admission).

4.1.4.1.2 Message Semantics

4.1.4.1.2.1 Message Semantics (HL7 v2.3.1)

1280 The Patient Registration transaction is conducted by the HL7 ADT message. The ADT Actor shall generate the message whenever a patient is admitted, pre-admitted or registered. In the event that a new patient will be seen as an outpatient at some future time, an ADT A04 message shall be used to convey patient information required by the Order Placer or Order Filler. Pre-

1285 admission of inpatients shall use the A05 message. The segments of the message listed below are required, and their detailed descriptions are provided in the following subsections.

One or more AL1 segments shall be present if any allergies are identified for the patient at the time of registration. It may be absent otherwise.

One or more OBX segments shall be present if the information about patient weight and/or height is present. They may be absent otherwise.

1290 Note: Additional qualifications to the level of specification and HL7 profiling are stated in Section 2.3.

Required segments are defined below. Other segments are optional

ADT	Patient Administration Message	Chapter in HL7 2.3.1
MSH	Message Header	2
EVN	Event Type	3
PID	Patient Identification	3
PV1	Patient Visit	3
[{OBX}]	Observation/Result	7
[{AL1}]	Allergy Information	3

1295 Each message shall be acknowledged by the HL7 ACK message sent by the receiver of ADT message to its sender. See Section 2.4.3 “Acknowledgement Modes” for definition and discussion of the ACK message.

4.1.4.1.2.1.1 MSH Segment (HL7 v2.3.1)

MSH segment shall be constructed as defined in the Section 2.4.2.2 “Message Control”.

1300 Field *MSH-9 Message Type* shall have at least two components. The first component shall have a value of “ADT”; the second component shall have values of A01, A04 or A05 as appropriate. The third component is optional; however, if present, it shall have a value of ADT_01.

4.1.4.1.2.1.2 EVN Segment (HL7 v2.3.1)

Table 4.1-1 identifies required and optional fields of the EVN segment.

Table 4.1-1: IHE Profile - EVN segment

SEQ	LEN	DT	OPT	TBL#	ITEM#	ELEMENT NAME
1	3	ID	O	0003	00099	Event Type Code
2	26	TS	R		00100	Recorded Date/Time
3	26	TS	O		00101	Date/Time Planned Event
4	3	IS	O	0062	00102	Event Reason Code
5	60	XCN	O	0188	00103	Operator ID
6	26	TS	R2		01278	Event Occurred

Adapted from the HL7 Standard, version 2.3.1

1305 Field *EVN-1 Event Type Code* is optional; however, if present, its value shall be equal to the second component of the field *MSH-9 Message Type*.

4.1.4.1.2.1.3 PID Segment (HL7 v2.3.1)

Table 4.1-2 identifies required and optional fields of the PID segment.

Table 4.1-2: IHE Profile - PID segment

SEQ	LEN	DT	OPT	TBL#	ITEM#	ELEMENT NAME
1	4	SI	O		00104	Set ID - Patient ID
2	20	CX	O		00105	Patient ID
3	20	CX	R		00106	Patient Identifier List
4	20	CX	O		00107	Alternate Patient ID
5	48	XPN	R		00108	Patient Name
6	48	XPN	O		00109	Mother's Maiden Name
7	26	TS	R2		00110	Date/Time of Birth
8	1	IS	R	0001	00111	Sex
9	48	XPN	O		00112	Patient Alias
10	80	CE	R2	0005	00113	Race
11	106	XAD	R2		00114	Patient Address
12	4	IS	O		00115	County Code
13	40	XTN	O		00116	Phone Number - Home
14	40	XTN	O		00117	Phone Number - Business
15	60	CE	O	0296	00118	Primary Language
16	1	IS	O	0002	00119	Marital Status
17	80	CE	O	0006	00120	Religion
18	20	CX	C		00121	Patient Account Number (<u>see note</u>)
19	16	ST	O		00122	SSN Number – Patient
20	25	DLN	O		00123	Driver's License Number - Patient
21	20	CX	O		00124	Mother's Identifier
22	80	CE	O	0189	00125	Ethnic Group
23	60	ST	O		00126	Birth Place
24	1	ID	O	0136	00127	Multiple Birth Indicator
25	2	NM	O		00128	Birth Order
26	80	CE	O	0171	00129	Citizenship
27	60	CE	O	0172	00130	Veterans Military Status
28	80	CE	O		00739	Nationality
29	26	TS	O		00740	Patient Death Date and Time
30	1	ID	O	0136	00741	Patient Death Indicator

1310

Adapted from the HL7 standard, version 2.3.1

1315

Note: At least one of the fields *PID-18 Patient Account Number* or *PV1-19 Visit Number* shall be valued. Additional requirements for the presence of value in these fields may be documented in regional or national extensions to the IHE Technical Framework (See RAD TF-4). Every system participating in the information exchange using HL7 shall use the field PID-3 Patient Identifier List to convey the Patient ID uniquely identifying the patient, typically at the Master Patient Index. If the Master Patient Index is not available, the ID initially assigned by the ADT/Registration System may be conveyed in this field (IHE Technical Framework currently does not provide for the use of an MPI). See appendix B and appendix D for further discussion of the use of PID-3 in transactions and its mapping from HL7 messages to DICOM Patient ID (0010,0020).

1320

Patient IDs included in the PID-3 field shall include Assigning Authority (Component 4). The first subcomponent (namespace ID) of Assigning Authority shall be populated. If the second and third subcomponents (universal ID and universal ID type) are also populated, they shall reference the same entity as is referenced in the first subcomponent.

4.1.4.1.2.1.4 PV1 Segment (HL7 v2.3.1)

Table 4.1-3: IHE Profile - PV1 Segment

SEQ	LEN	DT	OPT	TBL#	ITEM#	ELEMENT NAME
1	4	SI	O		00131	Set ID - PV1
2	1	IS	R	0004	00132	Patient Class
3	80	PL	C		00133	Assigned Patient Location
4	2	IS	O	0007	00134	Admission Type
5	20	CX	O		00135	Preadmit Number
6	80	PL	O		00136	Prior Patient Location
7	60	XCN	C	0010	00137	Attending Doctor
8	60	XCN	C	0010	00138	Referring Doctor
9	60	XCN	R2	0010	00139	Consulting Doctor
10	3	IS	C	0069	00140	Hospital Service
11	80	PL	O		00141	Temporary Location
12	2	IS	O	0087	00142	Preadmit Test Indicator
13	2	IS	O	0092	00143	Readmission Indicator
14	3	IS	O	0023	00144	Admit Source
15	2	IS	C	0009	00145	Ambulatory Status
16	2	IS	O	0099	00146	VIP Indicator
17	60	XCN	C	0010	00147	Admitting Doctor
18	2	IS	O	0018	00148	Patient Type
19	20	CX	C		00149	Visit Number
20	50	FC	O	0064	00150	Financial Class
21	2	IS	O	0032	00151	Charge Price Indicator
22	2	IS	O	0045	00152	Courtesy Code
23	2	IS	O	0046	00153	Credit Rating
24	2	IS	O	0044	00154	Contract Code
25	8	DT	O		00155	Contract Effective Date
26	12	NM	O		00156	Contract Amount

SEQ	LEN	DT	OPT	TBL#	ITEM#	ELEMENT NAME
27	3	NM	O		00157	Contract Period
28	2	IS	O	0073	00158	Interest Code
29	1	IS	O	0110	00159	Transfer to Bad Debt Code
30	8	DT	O		00160	Transfer to Bad Debt Date
31	10	IS	O	0021	00161	Bad Debt Agency Code
32	12	NM	O		00162	Bad Debt Transfer Amount
33	12	NM	O		00163	Bad Debt Recovery Amount
34	1	IS	O	0111	00164	Delete Account Indicator
35	8	DT	O		00165	Delete Account Date
36	3	IS	O	0112	00166	Discharge Disposition
37	25	CM	O	0113	00167	Discharged to Location
38	80	CE	O	0114	00168	Diet Type
39	2	IS	O	0115	00169	Servicing Facility
40	1	IS	O	0116	00170	Bed Status
41	2	IS	O	0117	00171	Account Status
42	80	PL	O		00172	Pending Location
43	80	PL	O		00173	Prior Temporary Location
44	26	TS	O		00174	Admit Date/Time
45	26	TS	O		00175	Discharge Date/Time
46	12	NM	O		00176	Current Patient Balance
47	12	NM	O		00177	Total Charges
48	12	NM	O		00178	Total Adjustments
49	12	NM	O		00179	Total Payments
50	20	CX	O	0203	00180	Alternate Visit ID
51	1	IS	C	0326	01226	Visit Indicator
52	60	XCN	O	0010	01224	Other Healthcare Provider

1325

Adapted from the HL7 standard, version 2.3.1

At least one of the fields *PID-18 Patient Account Number* or *PVI-19 Visit Number* shall be valued. Additional requirements for the presence of value in these fields may be documented in regional or national appendixes to the IHE Technical Framework (See RAD TF-4). Fields *PVI-3 Assigned Patient Location*, *PVI-7 Attending Doctor*, *PVI-10 Hospital Service*, *PVI-17 Admitting Doctor* shall be valued only when admitting in-patient, i.e., when the *MSH-9 Message Type* is ADT^A01.

1330

Field *PVI-8 Referring Doctor* shall be valued when registering an outpatient (*MSH-9 Message Type* is ADT^A04) or when pre-registering a patient (*MSH-9 Message Type* is ADT^A05).

1335

Field *PVI-15 Ambulatory Status* shall be valued when patient status indicates certain conditions such as pregnancy. May be omitted if none of the defined statuses are applicable to a patient.

Field *PVI-51 Visit Indicator* shall be valued with value “V” if the field *PVI-19 Visit Number* is present. May be omitted otherwise.

4.1.4.1.2.1.5 AL1 Segment (HL7 v2.3.1)

Table 4.1-4: IHE Profile – AL1 segment

SEQ	LEN	DT	OPT	TBL#	ITEM#	ELEMENT NAME
1	4	SI	R		00203	Set ID - AL1
2	2	IS	O	0127	00204	Allergy Type
3	60	CE	R		00205	Allergy Code/Mnemonic/Description
4	2	IS	O	0128	00206	Allergy Severity
5	15	ST	O		00207	Allergy Reaction
6	8	DT	O		00208	Identification Date

1340

Adapted from the HL7 standard, version 2.3.1

4.1.4.1.2.1.6 OBX Segment (HL7 v2.3.1)

The IHE Technical Framework includes the OBX segment primarily for the purposes of communicating patient height and weight. In this context, the optionality of fields *OBX-3 Observation Identifier* has been changed to “R2” and *OBX-4 Observation Result Status* has been changed to “O”. Please refer to appendix B for additional details on Patient Height and Weight mapping.

1345

Field *OBX-6 Units* is optional. When the OBX segments are sent to transmit the height and weight, this field shall be valued.

Table 4.1-5: IHE Profile - OBX Segment

SEQ	LEN	DT	OPT	TBL#	ITEM#	ELEMENT NAME
1	4	SI	O		00569	Set ID - OBX
2	3	ID	C	0125	00570	Value Type
3	80	CE	R		00571	Observation Identifier
4	20	ST	C		00572	Observation Sub-ID
5	65536 ³	*	C		00573	Observation Value
6	60	CE	O		00574	Units
7	60	ST	O		00575	References Range
8	5	ID	O	0078	00576	Abnormal Flags
9	5	NM	O		00577	Probability
10	2	ID	O	0080	00578	Nature of Abnormal Test

³ The length of the observation value field is variable, depending upon value type. See *OBX-2-value type*.

SEQ	LEN	DT	OPT	TBL#	ITEM#	ELEMENT NAME
11	1	ID	R	0085	00579	Observe Result Status
12	26	TS	O		00580	Date Last Obs Normal Values
13	20	ST	O		00581	User Defined Access Checks
14	26	TS	O		00582	Date/Time of the Observation
15	60	CE	O		00583	Producer's ID
16	80	XCN	O		00584	Responsible Observer
17	60	CE	O		00936	Observation Method

1350

Adapted from the HL7 Standard, version 2.3.1

4.1.4.1.2.2 Message Semantics (HL7 v2.5.1 Option)

Actors claiming the HL7 v2.5.1 Option shall implement the contents of this section. The actor shall also support the Message Semantics described in Section 4.1.4.1.2.1.

1355 Actors shall implement the message semantics of ITI-31 for each trigger event specified in Section 4.1.4.1.1.

The Patient Management-Admit/Register Patient messages are defined in the ITI Technical Framework as follows:

- ADT^A01 Admit Patient in ITI TF-2b:3.31.7.1 Admit/Visit Notification (ADT^A01^ADT_A01)
- 1360 • ADT^A04 Register Patient in ITI TF-2b:3.31.7.3 Register a Patient (ADT^A04^ADT_A01)
- ADT^A05 Pre-Admit Patient in ITI TF-2b:3.31.7.7 Pre-Admit (ADT^A05^ADT_A05)

Required segments are defined below. Other segments are optional.

1365

ADT	Patient Administration Message	Chapter in HL7 v2.5.1
MSH	Message Header	2
EVN	Event Type	3
PID	Patient Identification	3
PV1	Patient Visit	3
ROL	Role	15
[{OBX}]	Observation/Result	7
[{AL1}]	Allergy Information	3

1370

4.1.4.1.2.2.1 MSH Segment (HL7 v2.5.1 Option)

1375 The MSH segment shall be constructed as defined in ITI TF-2b:3.30.5.1 MSH – Header Segment. Additional specifications for actors complying with the IHE Radiology Technical Framework are defined in Section 2.4.

1380 Field *MSH-9-Message Type* shall have three components. The first component shall have a value of ADT; the second component shall have values of A01, A04 or A05 as appropriate. The third component shall have a value of ADT_A01 for the A01 and A04 trigger events, or ADT_A05 for the A05 trigger event.

4.1.4.1.2.2.2 EVN Segment (HL7 v2.5.1 Option)

The EVN segment shall be constructed as defined in ITI TF-2b:3.30.5.2 EVN – Event Type Segment.

4.1.4.1.2.2.3 PID Segment (HL7 v2.5.1 Option)

1385 The PID Segment shall be constructed as defined in ITI TF-2b:3.30.5.3 PID – Patient Identification Segment. Additional required and conditionally required fields are specified in Table 4.1-6.

Table 4.1-6: IHE Profile - PID Segment

SEQ	LEN	DT	OPT	TBL#	ITEM#	ELEMENT NAME
7	26	TS	R2		00110	Date/Time of Birth
8	1	IS	R	0001	00111	Administrative Sex
10	250	CE	R2	0005	00113	Race
11	250	XAD	R2		00114	Patient Address
18	250	CX	C		00121	Patient Account Number (see note)

Adapted from the HL7 standard, version 2.5.1

1390 Note: At least one of fields *PID-18-Patient Account Number* or *PV1-19 Visit-Number* shall be valued.

Additional requirements for the presence of value in these fields may be documented in regional or national extensions to the IHE Technical Framework (See RAD TF-4).

1395 The Patient ID obtained from a Master Patient Index shall be recorded in the PID-3-Patient Identifier List. See Appendix D for further discussion of the use of PID-3 in transactions and its mapping from HL7 messages to DICOM Patient ID (0010, 0020).

1400 Patient IDs in the PID-3 field shall include Assigning Authority (Component 4) and Identifier Type Code (Component 5). The first subcomponent (namespace ID) of Assigning Authority shall be populated. If the second and third subcomponents (universal ID and universal ID type) are also populated, they shall reference the same entity as is referenced in the first subcomponent. ITI TF-2b:3.30.5.3 provides additional details for implementing the PID-3 components.

4.1.4.1.2.2.4 PV1 Segment (HL7 v2.5.1 Option)

The PV1 Segment shall be constructed as defined in ITI TF-2b:3.30.5.4 PV1 - Patient Visit Segment.

1405 Additional optional, prohibited and conditionally required fields are specified in Table 4.1-7

Table 4.1-7: IHE Profile - PV1 Segment

SEQ	LEN	DT	OPT	TBL#	ITEM#	ELEMENT NAME
6	80	PL	O		00136	Prior Patient Location
7	250	XCN	C	0010	00137	Attending Doctor
8	250	XCN	C	0010	00138	Referring Doctor
9	250	XCN	X	0010	00139	Consulting Doctor
10	3	IS	C	0069	00140	Hospital Service
11	80	PL	O		00141	Temporary Location
15	2	IS	C	0009	00145	Ambulatory Status
17	250	XCN	C	0010	00147	Admitting Doctor
19	20	CX	C		00149	Visit Number
44	26	TS	O		00174	Admit Date/Time
45	26	TS	O		00175	Discharge Date/Time
51	1	IS	C	0326	01226	Visit Indicator

Adapted from the HL7 standard, version 2.5.1

1410 At least one of the *fields PID-18-Patient Account Number or PVI-19-Visit Number* shall be valued. Additional requirements for the presence of value in these fields may be documented in regional or national extensions to the IHE Technical Framework (See RAD TF-4).

Fields *PVI-3-Assigned Patient Location, PVI-7-Attending Doctor, PVI-10-Hospital Service, PVI-17-Admitting Doctor* shall be valued only when admitting an inpatient, i.e., when the value of *MSH-9-Message Type* is ADT^A01^ADT_A01.

1415 Field *PVI-8-Referring Doctor* shall be valued when registering an outpatient (*MSH-9-Message Type* is ADT^A04^ADT_A01) or when pre-registering a patient (*MSH-9-Message Type* is ADT^A05^ADT_A05).

The PV1 segment shall be followed for each of the attending doctor, admitting doctor, and referring doctor, by a ROL segment.

1420 Field *PVI-9-Consulting Doctor* shall not be present. The consulting doctor(s) are required and entirely described in the ROL segments.

Field *PVI-15-Ambulatory Status* shall be valued when patient status indicates pregnancy (patient is pregnant). It may be omitted otherwise.

Field *PVI-51-Visit Indicator* shall be valued with value “V” if the field *PVI-19-Visit Number* is valued. It may be omitted otherwise.

1425 **4.1.4.1.2.2.5 ROL Segment (HL7 v2.5.1 Option)**

One ROL segment shall be included for each attending doctor, admitting doctor, referring doctor and consulting doctor, if any. Note that some Provider Role codes in the ROL Segment use the word "Provider" rather than "Doctor".

The ROL Segment shall be constructed as defined in ITI TF-2b:3.30.5.6 ROL- Role Segment.

1430 **4.1.4.1.2.2.6 OBX Segment (HL7 v2.5.1 Option)**

The OBX Segment shall be constructed as defined in ITI TF-2b:3.30.5.7 OBX – Observation/Result Segment.

Additional optional, required and conditionally required fields are specified in Table 4.1-8.

Table 4.1-8: IHE Profile - OBX Segment

SEQ	LEN	DT	OPT	TBL#	ITEM #	ELEMENT NAME
2	2	ID	C	0125	00570	Value Type
3	250	CE	R2		00571	Observation Identifier
4	20	ST	C		00572	Observation Sub-ID
5	99999	varies	C		00573	Observation Value
6	250	CE	C		00574	Units
11	1	ID	R	0085	00579	Observe Result Status

1435

Adapted from the HL7 Standard, version 2.5.1

Refer to Appendix B for additional details on Patient Height and Weight mapping.

Field *OBX-6-Units* is required if the OBX segments are sent to transmit the height and weight.

4.1.4.1.2.2.7 AL1 Segment (HL7 v2.5.1 Option)

1440 The AL1 Segment shall be constructed as defined in ITI TF-2b:3.30.5.8 AL1 - Patient Allergy Information Segment.

4.1.4.1.3 Expected Actions

1445 The receiver of the ADT Patient Registration transaction message shall create a new patient record for the patient identified if there is no current record for the Patient ID (defined by the field *PID-3*). Interpretation of A01, A04 and A05 messages after the patient record was created is beyond the scope of the IHE Technical Framework; however, the ADT Patient Registration transaction shall not be used to update information in an existing patient record. Transaction RAD-12 Patient Update shall be used instead.

The interpretation of A01, A04 and A05 messages after the patient record was created is described in the ITI Technical Framework in the following ITI sections:

- 1450 • ITI TF-2b:3.31.7.1.4 Expected Actions for Admit/Visit Notification

- ITI TF-2b:3.31.7.3.4 Expected Actions for Register a Patient
- ITI TF-2b:3.31.7.7.4 Expected Actions for Pre-Admit

4.1.4.2 Patient Management – Cancel Admit/Register Patient

4.1.4.2.1 Trigger Events

1455 The following events will trigger one of the Admit/Register messages:

- A11 – Admission of an in-patient into a facility or registration of an outpatient for a visit of the facility has been cancelled due to error in the information or the decision not to admit/register patient after all.
- A38 – Pre-admission of an in-patient (i.e., registration of patient information ahead of actual admission) has been cancelled due to error in the information or the decision not to admit/register patient after all.

4.1.4.2.2 Message Semantics

4.1.4.2.2.1 Message Semantics (HL7 v2.3.1)

1465 Patient Registration conveyed by the HL7 ADT^A01, ADT^A04 or ADT^A05 may have to be revoked due to the errors in the information or the decision of not admitting/registering patient. The cancellation transaction is conveyed by the HL7 ADT^A11 or ADT^A38 messages. ADT^A11 shall be used to revoke the transaction conveyed by the ADT^A01 or ADT^A04 message. ADT^A38 shall be used to revoke transaction conveyed by the ADT^A05 message.

1470 Cancellation messages shall be used only if no other transactions were performed by the ADT on the patient record after the admit/registration transaction was conveyed.

The segments of the message listed below are required, and their detailed descriptions are provided in subsections below. All other segments are optional.

Note: Additional qualifications to the level of specification and HL7 profiling are stated in Section 2.3.

1475

ADT	Patient Administration Message	Chapter in HL7 2.3.1
MSH	Message Header	2
EVN	Event Type	3
PID	Patient Identification	3
PV1	Patient Visit	3

Each message shall be acknowledged by the HL7 ACK message sent by the receiver of ADT message to its sender. See Section 2.4.3 “Acknowledgement Modes” for definition and discussion of the ACK message.

4.1.4.2.2.1.1 MSH Segment (HL7 v2.3.1)

1480 MSH segment shall be constructed as defined in the Section 2.4.2.2 “Message Control”.

Field *MSH-9 Message Type* shall have at least two components. The first component shall have a value of “ADT”; the second component shall have values of A11 or A38 as appropriate. The third component is optional; however, if present, it shall have a value of ADT_A09 (for the A11 message) or ADT_A38 (for A38 message).

1485 **4.1.4.2.2.1.2 EVN Segment (HL7 v2.3.1)**

See Section 4.1.4.1.2.1.2 for required and optional fields of the EVN segment.

4.1.4.2.2.1.3 PID Segment (HL7 v2.3.1)

All of the fields in PID segment are optional, except those listed in Table 4.1-9. See Section 4.1.4.1.2.1.3 for the list of all fields of the PID segment.

1490 **Table 4.1-9: IHE Profile - PID segment**

SEQ	LEN	DT	OPT	TBL#	ITEM#	ELEMENT NAME
3	20	CX	R		00106	Patient Identifier List
5	48	XPN	R		00108	Patient Name
18	20	CX	C		00121	Patient Account Number

Adapted from the HL7 standard, version 2.3.1

4.1.4.2.2.1.4 PV1 Segment (HL7 v2.3.1)

All of the fields in PV1 segment are optional, except those listed in Table 4.1-10. See Section 4.1.4.1.2.1.4 for the list of all fields of the PV1 segment.

1495 **Table 4.1-10: IHE Profile - PV1 Segment**

SEQ	LEN	DT	OPT	TBL#	ITEM#	ELEMENT NAME
2	1	IS	R	0004	00132	Patient Class
19	20	CX	C		00149	Visit Number
51	1	IS	C	0326	01226	Visit Indicator

Adapted from the HL7 standard, version 2.3.1

1500 At least one of the fields *PID-18 Patient Account Number* or *PV1-19 Visit Number* shall be valued. Additional requirements for the presence of value in these fields may be documented in regional or national extensions to the IHE Radiology Technical Framework (See RAD TF-4). It is required if it has been present in the registration message A01, A04 or A05 that is being cancelled by this transaction.

Field *PV1-51 Visit Indicator* shall be valued with value “V” if the field *PV1-19 Visit Number* is present. May be omitted otherwise.

1505 **4.1.4.2.2.2 Message Semantics (HL7 v2.5.1 Option)**

Actors claiming the HL7 v2.5.1 Option shall implement the contents of this section. When an actor claims support for the HL7 v2.5.1 Option the actor is required to support the HL7 v2.5.1 interface requirements described in the referenced volumes and sections. The actor shall still support the HL7 v2.3.1 version of the transactions.

1510 The RAD-1 Patient Management-Cancel Admit/Register Patient transaction is implemented by the ITI PAM ITI-31 “Patient Encounter Management” triggers events and related messages:

- ADT^A11 Cancel Admit Patient
- ADT^A38 Cancel Pre-Admit Patient

The above messages are described in the following ITI Sections:

- 1515
- ITI TF-2b:3.31.7.2 Cancel Admit/Visit Notification (ADT^A11^ADT_A09)
 - ITI TF-2b:3.31.7.8 Cancel Pre-Admit (ADT^A38^ADT_A38)

4.1.4.2.2.2.1 MSH Segment (HL7 v2.5.1 Option)

1520 The MSH segment shall be constructed as defined in ITI TF-2b:3.30.5.1 MSH – Header Segment. Additional specifications for actors complying with the IHE Radiology Technical Framework are defined in Section 2.4.

Field *MSH-9-Message Type* shall have three components. The first component shall have a value of ADT; the second component shall have values of A11 or A38 as appropriate. The third component shall have a value of ADT_A09 (for the A11 message) or ADT_A38 (for the A38 message).

1525 **4.1.4.2.2.2.2 EVN Segment (HL7 v2.5.1 Option)**

The EVN segment shall be constructed as defined in ITI TF-2b:3.30.5.2 EVN – Event Type Segment.

4.1.4.2.2.2.3 PID Segment (HL7 v2.5.1 Option)

1530 All of the fields in the PID segment are optional, except those listed in Table 4.1-11. See Section 4.1.4.1.2.2.3 for a full discussion of the PID segment.

Table 4.1-11: IHE Profile - PID Segment

SEQ	LEN	DT	OPT	TBL#	ITEM#	ELEMENT NAME
3	250	CX	R		00106	Patient Identifier List
5	250	XPN	R		00108	Patient Name
18	250	CX	C		00121	Patient Account Number

Adapted from the HL7 standard, version 2.5.1

4.1.4.2.2.4 PV1 Segment (HL7 v2.5.1 Option)

1535 All of the fields in the PV1 segment are optional, except those listed in Table 4.1-12. See Section 4.1.4.1.2.2.4 for a full discussion of the PV1 segment.

Table 4.1-12: IHE Profile - PV1 Segment

SEQ	LEN	DT	OPT	TBL#	ITEM#	ELEMENT NAME
2	1	IS	R	0004	00132	Patient Class
19	250	CX	C		00149	Visit Number
51	1	IS	C	0326	01226	Visit Indicator

Adapted from the HL7 standard, version 2.5.1

1540 At least one of the fields *PID-18-Patient Account Number* or *PVI-19-Visit Number* shall be valued. Additional requirements for the presence of value in these fields may be documented in regional or national extensions to the IHE Technical framework (See RAD TF-4). It is required if it has been present in the registration message A01, A04 or A05 that is being cancelled by this transaction.

Field *PVI-51-Visit Indicator* shall be valued with value “V” if the field *PVI-19-Visit Number* is valued. It may be omitted otherwise.

1545 **4.1.4.2.3 Expected Actions**

If the patient record was created as a result of a Patient Registration transaction, such record shall be discarded. If the Patient Registration transaction was sent for an existing patient record, the corresponding operations shall be “rewound” to restore the record condition existing before Patient Transaction was sent.

1550

4.2 Placer Order Management [RAD-2]

This section corresponds to Transaction RAD-2 of the IHE Technical Framework. Transaction RAD-2 is used by the Order Placer and Department System Scheduler/Order Filler Actors.

1555 4.2.1 Scope

This transaction is used by the Order Placer to place a new order with the Order Filler. It also allows the Order Placer to cancel the order. For the Order Placer asserting compliance with HL7 Version 2.5.1, this transaction is used to change an order with the Order. For the Order Placer asserting compliance to HL7 Version 2.3.1, to change order information, the Order Placer would cancel the initial order and place the new one. The Order Placer and Department System Scheduler/Order Filler must agree on the support of recurring orders and panel orders, if used.

Recurring order: An order with a performance frequency greater than one. For example, portable chest x-ray at 6:00 AM for the next seven days.

1560 *Panel order:* A service item with more than one observation component. For example, a nuclear cardiac study that has a cardiology component and a radiology component that are usually reported on separately.

4.2.2 Use Case Roles

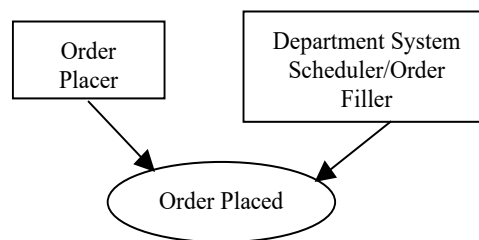

Actor: Order Placer

1570 **Role:** Places orders. Cancels orders as necessary.

Actor: Department System Scheduler/Order Filler

Role: Receives and processes (fills) orders. Receives order cancellations.

4.2.3 Referenced Standards

HL7 2.3.1 Chapter 4

1575 4.2.4 Interaction Diagram

The following diagram illustrates interactions between actors within systems implementing HL7 v2.3.1:

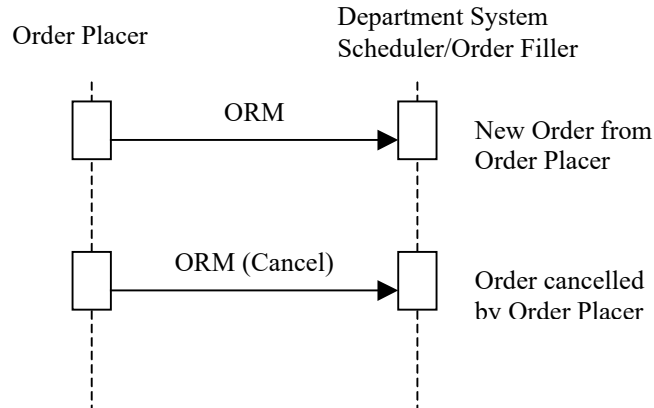

1580 The following diagram illustrates interactions between actors within systems implementing the HL7 v2.5.1:

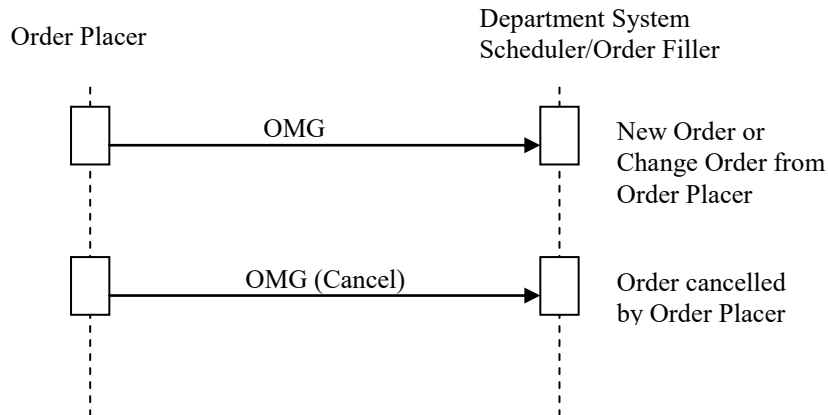

4.2.4.1 Order Management – New Order from Order Placer

4.2.4.1.1 Trigger Events

The following event will trigger the ORM messages within systems implementing HL7 v2.3.1:

1585 ORM – The Order Placer places a new order for the Department System Scheduler/Order Filler.

The following event will trigger the OMG messages within systems implementing HL7 v2.5.1:

OMG – The Order Placer places a new order for the Department System Scheduler/Order Filler.

4.2.4.1.2 Message Semantics

4.2.4.1.2.1 Message Semantics (HL7 v2.3.1)

1590 HL7 2.3.1 Chapter 4 ORM message. Refer to HL7 Standard for general message semantics.

The order start date/time or exam date/time is required in the “Quantity/Timing” field of both the ORC and OBR segments (ORC-7.4; OBR-27.4).

Note: Additional qualifications to the level of specification and HL7 profiling are stated in Section 2.3.

1595 Required segments are listed below. Other segments are optional.

ORM	General Order Message	Chapter in HL7 2.3.1
MSH	Message Header	2
PID	Patient Identification	3
PV1	Patient Visit	3
ORC	Common Order	4
OBR	Order Detail	4

Each message shall be acknowledged by the HL7 ACK message sent by the receiver of ADT message to its sender. See Section 2.4.3 “Acknowledgement Modes” for definition and discussion of the ACK message.

1600 **4.2.4.1.2.1.1 MSH Segment (HL7 v2.3.1)**

MSH segment shall be constructed as defined in the Section 2.4.2.2 “Message Control”.

Field *MSH-9 Message Type* shall have at least two components. The first component shall have a value of “ORM”; the second component shall have value of O01. The third component is optional; however, if present, it shall have a value of ORM_O01.

1605 **4.2.4.1.2.1.2 PID Segment (HL7 v2.3.1)**

All of the fields in PID segment are optional, except those listed in Table 4.2-1. See Section 4.1.4.1.2.1.3 for the list of all fields of the PID segment.

Table 4.2-1: IHE Profile - PID segment

SEQ	LEN	DT	OPT	TBL#	ITEM#	ELEMENT NAME
3	20	CX	R		00106	Patient Identifier List
5	48	XP	R		00108	Patient Name
18	20	CX	C		00121	Patient Account Number

Adapted from the HL7 standard, version 2.3.1

1610 **4.2.4.1.2.1.3 PV1 Segment (HL7 v2.3.1)**

All of the fields in PV1 segment are optional, except those listed in Table 4.2-2. See Section 4.1.4.1.2.1.4 for the list of all fields of the PV1 segment.

Table 4.2-2: IHE Profile - PV1 Segment

SEQ	LEN	DT	OPT	TBL#	ITEM#	ELEMENT NAME
2	1	IS	R	0004	00132	Patient Class
8	60	XCN	R2	0010	00138	Referring Doctor
19	20	CX	C		00149	Visit Number
51	1	IS	C	0326	01226	Visit Indicator

1615

Adapted from the HL7 standard, version 2.3.1

At least one of the fields *PID-18 Patient Account Number* or *PV1-19 Visit Number* shall be valued. Additional requirements for the presence of value in these fields may be documented in regional or national extensions to the IHE Radiology Technical Framework (See RAD TF-4).

1620

Field *PV1-51 Visit Indicator* shall be valued with value “V” if the field *PV1-19 Visit Number* is present. May be omitted otherwise.

4.2.4.1.2.1.4 ORC Segment (HL7 v2.3.1)

ORC segment conveys common order information.

Table 4.2-3: IHE Profile - ORC Segment

SEQ	LEN	DT	OPT	TBL#	ITEM #	ELEMENT NAME
1	2	ID	R	0119	00215	Order Control
2	22	EI	R		00216	Placer Order Number
3	22	EI	O		00217	Filler Order Number
4	22	EI	C		00218	Placer Group Number
5	2	ID	O	0038	00219	Order Status
6	1	ID	O	0121	00220	Response Flag
7	200	TQ	R		00221	Quantity/Timing
8	200	CM	C		00222	Parent
9	26	TS	R		00223	Date/Time of Transaction
10	120	XCN	R2		00224	Entered By
11	120	XCN	O		00225	Verified By
12	120	XCN	R		00226	Ordering Provider
13	80	PL	O		00227	Enterer's Location
14	40	XTN	R2		00228	Call Back Phone Number
15	26	TS	O		00229	Order Effective Date/Time
16	200	CE	O		00230	Order Control Code Reason
17	60	CE	R		00231	Entering Organization
18	60	CE	O		00232	Entering Device
19	120	XCN	O		00233	Action By

Adapted from the HL7 Standard, version 2.3.1

1625 Field *ORC-3 Filler Order Number* shall not be present.

Field *ORC-4 Placer Group Number* shall be valued only if the Order Placer and Order Filler utilize concept of Order Groups. Shall not be present otherwise.

Field *ORC-8 Parent* shall be valued only if the current order is a child order (i.e., if the field *ORC-1 Order Control* has a value of CH).

1630 The action to be performed in the ORM message is defined by the Order Control code passed as part of the message. HL7 defines a number of Order Control codes.

The order control codes below shall be supported.

Supported Order Control Codes

Value	Description
NW ^R	New order
PA ^O	Parent order
CH ^O	Child order

Adapted from the HL7 Standard, version 2.3.1

1635 ^R=Required; ^O=Optional

Note: The use of Required/Optional superscripts in the Value column is an IHE extension and is not part of the HL7 Standard.

4.2.4.1.2.1.5 OBR Segment (HL7 v2.3.1)

Table 4.2-4: IHE Profile - OBR Segment

SEQ	LEN	DT	OPT	TBL#	ITEM #	ELEMENT NAME
1	4	SI	O		00237	Set ID - OBR
2	75	EI	R		00216	Placer Order Number
3	75	EI	O		00217	Filler Order Number
4	200	CE	R		00238	Universal Service ID
5	2	ID	O		00239	Priority
6	26	TS	O		00240	Requested Date/time
7	26	TS	O		00241	Observation Date/Time
8	26	TS	O		00242	Observation End Date/Time
9	20	CQ	O		00243	Collection Volume
10	60	XCN	O		00244	Collector Identifier
11	1	ID	O	0065	00245	Specimen Action Code
12	60	CE	R2		00246	Danger Code
13	300	ST	C		00247	Relevant Clinical Info.
14	26	TS	O		00248	Specimen Received Date/Time
15	300	CM	C	0070	00249	Specimen Source

SEQ	LEN	DT	OPT	TBL#	ITEM #	ELEMENT NAME
16	80	XCN	R		00226	Ordering Provider
17	40	XTN	O		00250	Order Callback Phone Number
18	60	ST	O		00251	Placer field 1
19	60	ST	O		00252	Placer field 2
20	60	ST	O		00253	Filler Field 1
21	60	ST	O		00254	Filler Field 2
22	26	TS	O		00255	Results Rpt/Status Chng - Date/Time
23	40	CM	O		00256	Charge to Practice
24	10	ID	O	0074	00257	Diagnostic Serv Sect ID
25	1	ID	O	0123	00258	Result Status
26	400	CM	O		00259	Parent Result
27	200	TQ	R		00221	Quantity/Timing
28	150	XCN	O		00260	Result Copies To
29	150	CM	C		00261	Parent
30	20	ID	R2	0124	00262	Transportation Mode
31	300	CE	R2		00263	Reason for Study
32	200	CM	O		00264	Principal Result Interpreter
33	200	CM	O		00265	Assistant Result Interpreter
34	200	CM	O		00266	Technician
35	200	CM	O		00267	Transcriptionist
36	26	TS	O		00268	Scheduled Date/Time
37	4	NM	O		01028	Number of Sample Containers
38	60	CE	O		01029	Transport Logistics of Collected Sample
39	200	CE	O		01030	Collector's Comment
40	60	CE	O		01031	Transport Arrangement Responsibility
41	30	ID	R2	0224	01032	Transport Arranged
42	1	ID	O	0225	01033	Escort Required
43	200	CE	O		01034	Planned Patient Transport Comment
44	80	CE	O	0088	00393	Procedure Code
45	80	CE	O	0340	01036	Procedure Code Modifier

1640

Adapted from the HL7 Standard, version 2.3.1

Field *OBR-13 Relevant Clinical Info* shall be populated if patient record contains any medical alerts that may be relevant to the order and, in particular, need to be communicated to the technologist.

1645 Field *OBR-15 Specimen Source* holds the laterality (Left/Right) indicator (when used) in the <site modifier (CE)> component. See Appendix B for details.

Per the HL7 Standard, IHE recommends that the fields in ORC and OBR segments given in the following table contain the same information.

Identical Element Mappings between ORC and OBR Segments

Element Name	ORC Segment Element	OBR Segment Element
Placer Order Number	ORC-2	OBR-2
Filler Order Number	ORC-3	OBR-3
Quantity/Timing	ORC-7	OBR-27
Parent	ORC-8	OBR-29

4.2.4.1.2.2 Message Semantics (HL7 v2.5.1 Option)

1650 Actors claiming the HL7 v2.5.1 Option shall implement the contents of this section. When an actor claims support for the HL7 v2.5.1 Option the actor is required to support the HL7 v2.5.1 interface requirements described in the referenced volumes and sections. The actor shall still support the HL7 v2.3.1 version of the transactions.

1655 The HL7 v2.5.1 Option implements the Chapter 4 OMG message. Refer to the HL7 Standard for general message semantics.

Note: Additional qualifications to the level of specification and HL7 profiling are stated in Section 2.3.

Required segments are listed below. Other segments are optional.

OMG	General Clinical Order Message	Chapter in HL7 v2.5.1
MSH	Message Header	2
PID	Patient Identification	3
PV1	Patient Visit	3
ORC	Common Order	4
TQ1	Timing/Quantity	4
OBR	Order Detail	4

1660 Each message shall be acknowledged by the HL7 ACK message sent by the receiver of the OMG message to its sender. See Section 2.4.4 for definition and discussion of the ACK message.

4.2.4.1.2.2.1 MSH Segment (HL7 v2.5.1 Option)

1665 The MSH segment shall be constructed as defined in ITI TF-2b:3.30.5.1 MSH – Header Segment. Additional specifications for actors complying with the IHE Radiology Technical Framework are defined in Section 2.4.

Field *MSH-9-Message Type* shall have three components. The first component shall have a value of *OMG*; the second component shall have a value of *O19*; the third component shall have a value of *OMG_O19*.

4.2.4.1.2.2.2 PID Segment (HL7 v2.5.1 Option)

1670 All of the fields in the PID segment are optional, except those listed in Table 4.2-5. See Section 4.1.4.1.2.2.3 for further discussion of the PID segment.

Table 4.2-5: IHE Profile - PID segment

SEQ	LEN	DT	OPT	TBL#	ITEM#	ELEMENT NAME
3	250	CX	R		00106	Patient Identifier List
5	250	XP	R		00108	Patient Name
18	250	CX	C		00121	Patient Account Number

Adapted from the HL7 standard, version 2.5.1

4.2.4.1.2.2.3 PV1 Segment (HL7 v2.5.1 Option)

1675 All of the fields in the PV1 segment are optional, except those listed in Table 4.2-6. See Section 4.1.4.1.2.2.4 for a full discussion of the PV1 segment.

Table 4.2-6: IHE Profile - PV1 Segment

SEQ	LEN	DT	OPT	TBL#	ITEM#	ELEMENT NAME
2	1	IS	R	0004	00132	Patient Class
8	250	XC	R2	0010	00138	Referring Doctor
19	250	CX	C		00149	Visit Number
51	1	IS	C	0326	01226	Visit Indicator

Adapted from the HL7 standard, version 2.5.1

1680 At least one of the fields *PID-18-Patient Account Number* or *PV1-19-Visit Number* shall be valued. Additional usage requirements for these fields may be documented in regional or national extensions to the IHE Radiology Technical Framework (See RAD TF-4).

Field *PV1-51-Visit Indicator* shall be valued with value “V” if the field *PV1-19-Visit Number* is valued. It may be omitted otherwise.

4.2.4.1.2.2.4 ORC Segment (HL7 v2.5.1 Option)

1685 The ORC segment conveys common order information.

Table 4.2-7: IHE Profile - ORC Segment

SEQ	LEN	DT	OPT	TBL#	ITEM #	ELEMENT NAME
1	2	ID	R	0119	00215	Order Control
2	22	EI	R		00216	Placer Order Number
3	22	EI	X		00217	Filler Order Number
4	22	EI	C		00218	Placer Group Number
5	2	ID	O	0038	00219	Order Status
6	1	ID	O	0121	00220	Response Flag
7	200	TQ	X		00221	Quantity/Timing
8	200	EIP	C		00222	Parent
9	26	TS	R		00223	Date/Time of Transaction
10	250	XCN	R2		00224	Entered By
11	250	XCN	O		00225	Verified By
12	250	XCN	R		00226	Ordering Provider
13	80	PL	O		00227	Enterer's Location
14	250	XTN	R2		00228	Call Back Phone Number
15	26	TS	O		00229	Order Effective Date/Time
16	250	CE	O		00230	Order Control Code Reason
17	250	CE	R		00231	Entering Organization
18	250	CE	O		00232	Entering Device
19	250	XCN	O		00233	Action By
20	250	CE	O	0339	01310	Advanced Beneficiary Notice Code
21	250	XON	O		01311	Ordering Facility Name
22	250	XAD	O		01312	Ordering Facility Address
23	250	XTN	O		01313	Ordering Facility Phone Number
24	250	XAD	O		01314	Ordering Provider Address
25	250	CWE	O		01473	Order Status Modifier
26	60	CWE	C	0552	01641	Advanced Beneficiary Notice Override Reason
27	26	TS	O		01642	Filler's Expected Availability Date/Time
28	250	CWE	O	0177	00615	Confidentiality Code
29	250	CWE	O	0482	01643	Order Type
30	250	CNE	O	0483	01644	Enterer Authorization Mode
31	250	CWE	O		02286	Parent Universal Service Identifier

Adapted from the HL7 Standard, version 2.5.1

Field *ORC-3-Filler Order Number* shall not be present.

1690 Field *ORC-4-Placer Group Number* shall be valued only if the Order Placer and Order Filler utilize the concept of Order Groups. It shall not be present otherwise.

Field ORC-7-Quantity/Timing is not populated. It has been superseded by the TQ1 segment.

Field *ORC-8-Parent* shall be valued only if the current order is a child order (i.e., if the field *ORC-1-Order Control* has a value of CH).

- 1695 The action to be performed in the OMG message is defined by *ORC-1-Order Control Code*. HL7 defines a number of order control codes.

The following Order Control Codes are supported.

Supported Order Control Codes

Value	Description
NW ^R	New order
PA ^O	Parent order
CH ^O	Child order
XO ^R	Change order

Adapted from the HL7 Standard, version 2.5.1

- 1700 ^R=Required; ^O=Optional

Note: The use of Required/Optional superscripts in the Value column is an IHE extension and is not part of the HL7 Standard.

4.2.4.1.2.2.5 TQ1 Segment (HL7 v2.5.1 Option)

- 1705 Deprecated components ORC-7.4-Start Date/Time or OBR-27.4-Start Date/Time shall not be populated but instead the TQ1 segment shall be used to carry the start date and time of the procedure.

Table 4.2-8: IHE Profile – TQ1 Segment

SEQ	LEN	DT	OPT	TBL#	ITEM #	ELEMENT NAME
1	4	SI	O		01627	Set ID – TQ1
2	20	CQ	O		01628	Quantity
3	540	RPT	O	0335	01629	Repeat Pattern
4	20	TM	O		01630	Explicit Time
5	20	CQ	O		01631	Relative Time and Units
6	20	CQ	O		01632	Service Duration
7	26	TS	R		01633	Start Date/Time
8	26	TS	O		01634	End Date/Time
9	250	CWE	O	0485	01635	Priority
10	250	TX	O		01636	Condition Text
11	250	TX	O	0065	01637	Text Instruction
12	10	ID	C	0472	01638	Conjunction
13	20	CQ	O		01639	Occurrence Duration

SEQ	LEN	DT	OPT	TBL#	ITEM #	ELEMENT NAME
14	10	NM	O		01640	Total Occurrences

Adapted from the HL7 Standard, version 2.5.1

Field *TQ1-7-Start Date/Time* shall contain the date and time of the exam.

1710 4.2.4.1.2.2.6 OBR Segment (HL7 v2.5.1 Option)

Table 4.2-9: IHE Profile - OBR Segment

SEQ	LEN	DT	OPT	TBL#	ITEM #	ELEMENT NAME
1	4	SI	O		00237	Set ID – OBR
2	22	EI	R		00216	Placer Order Number
3	22	EI	O		00217	Filler Order Number
4	250	CE	R		00238	Universal Service ID
5	2	ID	O		00239	Priority
6	26	TS	O		00240	Requested Date/time
7	26	TS	O		00241	Observation Date/Time
8	26	TS	O		00242	Observation End Date/Time
9	20	CQ	O		00243	Collection Volume
10	250	XCN	O		00244	Collector Identifier
11	1	ID	O	0065	00245	Specimen Action Code
12	250	CE	R2		00246	Danger Code
13	300	ST	C		00247	Relevant Clinical Info.
14	26	TS	X		00248	Specimen Received Date/Time
15	300	SPS	X	0070	00249	Specimen Source
16	250	XCN	R		00226	Ordering Provider
17	250	XTN	O		00250	Order Callback Phone Number
18	60	ST	O		00251	Placer field 1
19	60	ST	O		00252	Placer field 2
20	60	ST	O		00253	Filler Field 1
21	60	ST	O		00254	Filler Field 2
22	26	TS	O		00255	Results Rpt/Status Chng - Date/Time
23	40	MOC	O		00256	Charge to Practice
24	10	ID	O	0074	00257	Diagnostic Serv Sect ID
25	1	ID	O	0123	00258	Result Status
26	400	PRL	O		00259	Parent Result
27	200	TQ	X		00221	Quantity/Timing
28	250	XCN	O		00260	Result Copies To
29	200	EIP	C		00261	Parent

SEQ	LEN	DT	OPT	TBL#	ITEM #	ELEMENT NAME
30	20	ID	R2	0124	00262	Transportation Mode
31	250	CE	R2		00263	Reason for Study
32	200	NDL	O		00264	Principal Result Interpreter
33	200	NDL	O		00265	Assistant Result Interpreter
34	200	NDL	O		00266	Technician
35	200	NDL	O		00267	Transcriptionist
36	26	TS	O		00268	Scheduled Date/Time
37	4	NM	O		01028	Number of Sample Containers
38	250	CE	O		01029	Transport Logistics of Collected Sample
39	250	CE	O		01030	Collector's Comment
40	250	CE	O		01031	Transport Arrangement Responsibility
41	30	ID	R2	0224	01032	Transport Arranged
42	1	ID	O	0225	01033	Escort Required
43	250	CE	O		01034	Planned Patient Transport Comment
44	250	CE	O	0088	00393	Procedure Code
45	250	CE	O	0340	01036	Procedure Code Modifier
46	250	CE	R2	0411	01474	Placer Supplemental Service Information
47	250	CE	R2	0411	01475	Filler Supplemental Service Information
48	250	CWE	R2	0476	01646	Medically Necessary Duplicate Procedure Reason
49	2	IS	O	0507	01647	Result Handling
50	250	CWE	O		02286	Parent Universal Service Identifier

Adapted from the HL7 Standard, version 2.5.1

1715 Field *OBR-13-Relevant Clinical Info* shall be populated if the patient record contains any medical alerts that may be relevant to the order and, in particular, need to be communicated to the technologist.

Field *OBR-27-Quantity/Timing* shall not be present. The date and time of the exam shall be carried in field *TQ1-7-Start Date/Time*.

1720 Field *OBR-46-Placer Supplemental Service Information* shall contain the laterality (Left/Right) indicator (when applicable). Field *OBR-15-Specimen Source*, which had formerly been adapted for this use by the IHE Technical Framework and has been deprecated in HL7 Version 2.5.1, shall not be present. See Appendix B for details.

Per the HL7 Standard, IHE recommends that the fields in ORC and OBR segments given in the following table contain the same information.

Identical Element Mappings between ORC and OBR Segments

Element Name	ORC Segment Element	OBR Segment Element
Placer Order Number	ORC-2	OBR-2
Filler Order Number	ORC-3	OBR-3
Parent	ORC-8	OBR-29

1725 **4.2.4.1.3 Expected Actions**

Department System Scheduler/Order Filler shall accept the order information for fulfillment. If error in data prevents it from fulfilling the order, it shall notify the Order Placer by returning proper information in the ACK message.

1730 For actors claiming the HL7 v2.5.1 Option, the Order Placer shall not change an order that has already been started, e.g., one for which Order Filler has transmitted an “In-Progress” status in the Order Status message in the RAD-3 transaction (see Section 4.3.4.2). However, if the Order Filler receives the change order message after it has sent the Order Status Update message (for example, in a case of a race condition between two messages), Order Filler shall accept the change order and perform transaction RAD-13 Procedure Update to notify Image Manager.

1735 **4.2.4.2 Order Management - Order Cancelled by Order Placer**

4.2.4.2.1 Trigger Events

The following event will trigger the ORM messages within systems implementing HL7 v2.3.1:

ORM – Order Placer cancels an order (control code = CA).

ORM – Order Placer discontinues (attempts to stop) an ongoing order (control code = DC).

1740 The following event will trigger the OMG messages within systems implementing HL7 v2.5.1:

OMG – Order Placer cancels an order (control code = CA).

OMG – Order Placer discontinues (attempts to stop) an ongoing order (control code = DC).

4.2.4.2.2 Message Semantics

4.2.4.2.2.1 Message Semantics (HL7 v.2.3.1)

1745 HL7 2.3.1 Chapter 4 ORM message. Refer to HL7 standard for general message semantics. Refer to Section 4.2.4.1.2.1 above for detailed requirements of the ORM message.

Note: Additional qualifications to the level of specification and HL7 profiling are stated in Section 2.3.

Required segments are listed below. Other segments are optional.

1750

ORM	General Order Message	Chapter in HL7 2.3.1
MSH	Message Header	2

ORM	General Order Message	Chapter in HL7 2.3.1
PID	Patient Identification	3
PV1	Patient Visit	3
ORC	Common Order	4

Each message shall be acknowledged by the HL7 ACK message sent by the receiver of ADT message to its sender. See Section 2.4.3 “Acknowledgement Modes” for definition and discussion of the ACK message.

4.2.4.2.2.1.1 MSH Segment (HL7 v2.3.1)

1755 MSH segment shall be constructed as defined in the Section 2.4.2.2 “Message Control”.

Field *MSH-9 Message Type* shall have at least two components. The first component shall have a value of “ORM”; the second component shall have a value of O01. The third component is optional; however, if present, it shall have a value of ORM_O01.

4.2.4.2.2.1.2 PID Segment (HL7 v2.3.1)

1760 All of the fields in PID segment are optional, except those listed in Table 4.2-10. See Section 4.1.4.1.2.1.3 for the list of all fields of the PID segment.

Table 4.2-10: IHE Profile - PID segment

SEQ	LEN	DT	OPT	TBL#	ITEM#	ELEMENT NAME
3	20	CX	R		00106	Patient Identifier List
5	48	XPN	R		00108	Patient Name
18	20	CX	C		00121	Patient Account Number

Adapted from the HL7 standard, version 2.3.1

4.2.4.2.2.1.3 PV1 Segment (HL7 v2.3.1)

1765 All of the fields in PV1 segment are optional, except those listed in Table 4.2-11. See Section 4.1.4.1.2.1.4 for the list of all fields of the PV1 segment.

Table 4.2-11: IHE Profile - PV1 Segment

SEQ	LEN	DT	OPT	TBL#	ITEM#	ELEMENT NAME
2	1	IS	R	0004	00132	Patient Class
19	20	CX	C		00149	Visit Number
51	1	IS	C	0326	01226	Visit Indicator

Adapted from the HL7 standard, version 2.3.1

1770 At least one of the fields *PID-18 Patient Account Number* or *PV1-19 Visit Number* shall be valued. Additional requirements for the presence of value in these fields may be documented in regional or national extensions to the IHE Radiology Technical Framework (See RAD TF-4).

Field *PV1-51 Visit Indicator* shall be valued with value “V” if the field *PV1-19 Visit Number* is present. May be omitted otherwise.

4.2.4.2.2.1.4 ORC Segment (HL7 v2.3.1)

1775 All of the fields in ORC segment are optional, except those listed in Table 4.2-12. See Section 4.2.4.1.2.1.4 for the list of all fields of the ORC segment.

Table 4.2-12: IHE Profile - ORC Segment

SEQ	LEN	DT	OPT	TBL#	ITEM #	ELEMENT NAME
1	2	ID	R	0119	00215	Order Control
2	22	EI	R		00216	Placer Order Number

Adapted from the HL7 Standard, version 2.3.1

1780 The action to be performed in the ORM message is defined by the Order Control code passed as part of the message. HL7 defines a number of Order Control codes.

The order control codes below shall be supported.

IHE Profile - Supported Order Control Codes

Value	Description
CA	Cancel order request
DC	Discontinue Order request

4.2.4.2.2.2 Message Semantics (HL7 v2.5.1 Option)

1785 Actors claiming the HL7 v2.5.1 Option shall implement the contents of this section. When an actor claims support for the HL7 v2.5.1 Option the actor is required to support the HL7 v2.5.1 interface requirements described in the referenced volumes and sections. The actor shall still support the HL7 v2.3.1 version of the transactions.

HL7 v2.5.1 Chapter 4 OMG message. Refer to HL7 standard for general message semantics. Refer to Section 4.2.4.1.2.6 above for detailed requirements of the OMG message.

1790 Note: Additional qualifications to the level of specification and HL7 profiling are stated in Section 2.3.

Required segments are listed below. Other segments are optional.

OMG	General Clinical Order Message	Chapter in HL7 v2.5.1
MSH	Message Header	2
PID	Patient Identification	3
PV1	Patient Visit	3
ORC	Common Order	4

1795 Each message shall be acknowledged by the HL7 ACK message sent by the receiver of the OMG message to its sender. See Section 2.4.4.3 “Acknowledgement Modes” for definition and discussion of the ACK message.

4.2.4.2.2.2.1 MSH Segment (HL7 v2.5.1 Option)

The MSH segment shall be constructed as defined in ITI TF-2b:3.30.5.1 MSH – Header Segment. Additional specifications for actors complying with the IHE Radiology Technical Framework are defined in Section 2.4.

1800 Field *MSH-9-Message Type* shall have three components. The first component shall have a value of OMG; the second component shall have a value of O19; the third component shall have a value of OMG_O19.

4.2.4.2.2.2.2 PID Segment (HL7 v2.5.1 Option)

1805 All of the fields in the PID segment are optional, except those listed in Table 4.2-13. See Section 4.1.4.1.2.2.3 for further discussion of the PID segment.

Table 4.2-13: IHE Profile - PID segment

SEQ	LEN	DT	OPT	TBL#	ITEM#	ELEMENT NAME
3	250	CX	R		00106	Patient Identifier List
5	250	XPN	R		00108	Patient Name
18	250	CX	C		00121	Patient Account Number

Adapted from the HL7 standard, version 2.5.1

4.2.4.2.2.2.3 PV1 Segment (HL7 v2.5.1 Option)

1810 All of the fields in the PV1 segment are optional, except those listed in Table 4.2-14. See Section 4.1.4.1.2.2.4 for a full discussion of the PV1 segment.

Table 4.2-14: IHE Profile - PV1 Segment

SEQ	LEN	DT	OPT	TBL#	ITEM#	ELEMENT NAME
2	1	IS	R	0004	00132	Patient Class
19	250	CX	C		00149	Visit Number
51	1	IS	C	0326	01226	Visit Indicator

Adapted from the HL7 standard, version 2.5.1

1815 At least one of the fields *PID-18-Patient Account Number* or *PV1-19-Visit Number* shall be valued. Additional usage requirements for these fields may be documented in regional or national extensions to the IHE Technical Framework (See RAD TF-4).

Field *PV1-51-Visit Indicator* shall be valued with value “V” if the field *PV1-19-Visit Number* is valued. It may be omitted otherwise.

4.2.4.2.2.4 ORC Segment (HL7 v2.5.1 Option)

1820 All of the fields in ORC segment are optional, except those listed in Table 4.2-15. See Section 4.2.4.1.2.2.4 for the list of all fields of the ORC segment.

Table 4.2-15: IHE Profile - ORC Segment

SEQ	LEN	DT	OPT	TBL#	ITEM #	ELEMENT NAME
1	2	ID	R	0119	00215	Order Control
2	22	EI	R		00216	Placer Order Number

Adapted from the HL7 Standard, version 2.5.1

The action to be performed in the OMG message is defined by the Order Control code passed as part of the message. HL7 defines a number of Order Control codes.

1825 The order control codes below shall be supported.

IHE Profile - Supported Order Control Codes

Value	Description
CA	Cancel order request
DC	Discontinue Order request

4.2.4.2.3 Expected Actions

1830 After receiving the Order Management message with the control code CA, DSS/Order Filler shall discard the record of the order and shall not attempt to schedule or otherwise to fulfill it. If the DSS/Order Filler has already scheduled the procedures corresponding to the order, it has to perform Transaction RAD-13 Procedure Update (see Section 4.13) to notify the Image Manager of order cancellation.

1835 Order Placer shall not cancel order that has already been started, i.e., the one for which Order Filler transmitted the “In-Progress” status (see Section 4.3.4.2). However, if the Order Filler receives the cancellation message after it has sent the Status Update message (for example, in a case of a race condition between two messages), Order Filler shall accept order cancellation and perform Transaction RAD-13 Procedure Update to notify Image Manager.

1840 It is expected that in most cases Order Placer will utilize the Order Management message with the control code of CA. However, in some cases (such as with recurring orders – to stop the order fulfillment before all its parts were completed), Order Placer and Order Filler may agree on a use of the Order Management message with the control code DC. Upon receiving such Order Management message, DSS/Order Filler shall perform transaction RAD-13 Procedure Update (see Section 4.13) to notify the Image Manager of order discontinuation

1845 **4.3 Filler Order Management [RAD-3]**

This section corresponds to Transaction RAD-3 of the IHE Technical Framework. Transaction RAD-3 is used by the Order Placer and Department System Scheduler/Order Filler Actors.

4.3.1 Scope

1850 This transaction is used by the Order Filler to inform the Order Placer about the orders it creates and cancels, including the status of the orders it is fulfilling.

A 1:1 relationship between Placer Order and Filler Order shall be maintained.

4.3.2 Use Case Roles

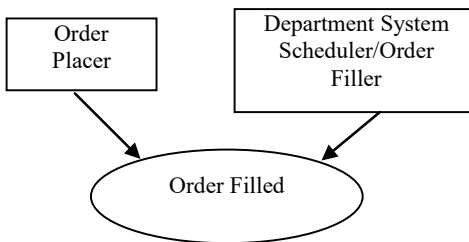

Actor: Order Placer

1855 **Role:** Receives new order, order change (HL7 v2.5.1 Option) and order cancellation requests from Order Filler. Receives Order Status updates from Order Filler.

Actor: Department System Scheduler/Order Filler

Role: Creates new or cancels existing orders; sends notifications of order status to the Order Placer.

1860 **4.3.3 Referenced Standards**

HL7 v2.3.1 Chapter 4

HL7 v2.5.1 Chapter 4

4.3.4 Interaction Diagram

The following diagram illustrates interactions between actors implementing HL7 v2.3.1

1865

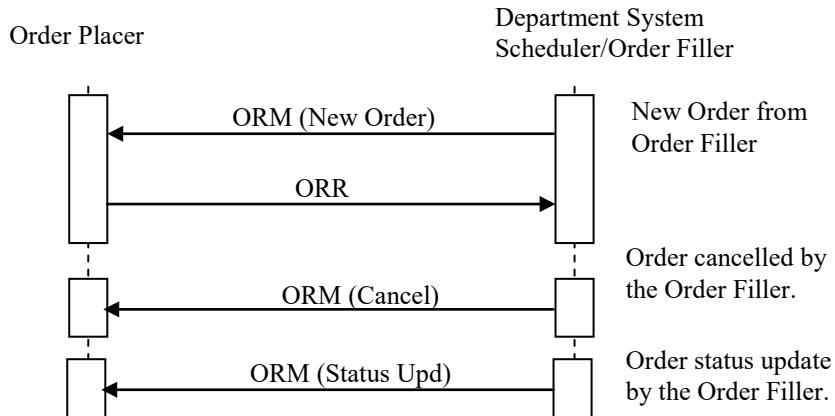

The following diagram illustrates interactions between actors implementing HL7 v2.5.1:

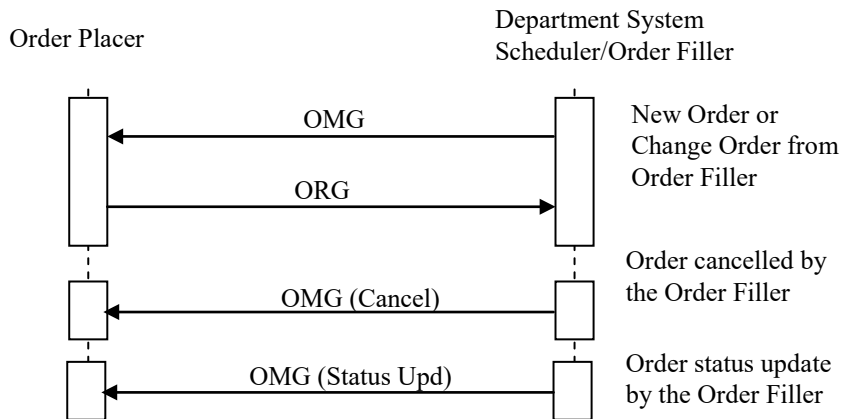

1870 **4.3.4.1 Filler Order Management – New Order from Order Filler or Change Order from Order Filler**

4.3.4.1.1 Trigger Events

ORM - Department system Scheduler/Order Filler places an order (control code = SN).

ORR – Order Placer replies (control code = NA).

1875 Systems claiming the HL7 v2.5.1 Option shall implement the following:

OMG - Department system Scheduler/Order Filler places an order (control code = SN) or changes an order (control code = XX).

ORG – Order Placer replies (control code = NA).

1880 The ORR (HL7 v2.3.1) or ORG (HL7 v2.5.1) messages are sent by the Order Placer to convey the Order Placer Number in those cases where the DSS/Order Filler places the Order. ORR messages shall not be used as acknowledgements in other cases.

4.3.4.1.2 Message Semantics

4.3.4.1.2.1 Message Semantics (HL7 v2.3.1)

1885 HL7 2.3.1 Chapter 4 ORM message. Refer to HL7 Standard for general message semantics. Refer to Section 4.2.4.1.2.1 above for detailed requirements for the ORM message.

HL7 2.3.1 Chapter 4 ORR message. Refer to HL7 Standard for general message semantics.

See Section 2.4.2.2 of this document for MSH and MSA segment definition.

Note: Additional qualifications to the level of specification and HL7 profiling are stated in Section 2.3.

Required segments are listed below. Other segments are optional.

1890

ORM	General Order Message	Chapter in HL7 2.3.1
MSH	Message Header	2
PID	Patient Identification	3
PV1	Patient Visit	3
ORC	Common Order	4
OBR	Order Detail	4

ORR (Success)	General Order Message	Chapter in HL7 2.3.1
MSH	Message Header	2
MSA	Message Acknowledgement	2
ORC	Common Order	4
OBR	Order Detail	4

ORR (Error)	General Order Message	Chapter in HL7 2.3.1
MSH	Message Header	2
MSA	Message Acknowledgement	2
ERR	Error	2

1895 Each message shall be acknowledged by the HL7 ACK message sent by the receiver of ADT message to its sender. See Section 2.4.3 “Acknowledgement Modes” for definition and discussion of the ACK message.

4.3.4.1.2.1.1 MSH Segment (HL7 v2.3.1)

MSH segment shall be constructed as defined in Section 2.4.2.2 “Message Control”.

1900 Field *MSH-9 Message Type* shall have at least two components. The first component shall have a value of “ORM” for ORM message and “ORR” for ORR message; the second component shall have value of O01 or O02, respectively. The third component is optional; however, if present, it shall have a value of ORM_O01 or ORR_O02, respectively.

4.3.4.1.2.1.2 MSA Segment (HL7 v2.3.1)

MSA segment in the ORR (Success) or ORR (Error) message shall be constructed as defined in the Section 2.4.3 “Acknowledgement Modes”.

1905 Field *MSA-6 Error condition* in ORR (Error) shall have the Error code value of 204 (Unknown Key Identifier)

4.3.4.1.2.1.3 PID Segment (HL7 v2.3.1)

All of the fields in PID segment are optional, except those listed in Table 4.3-1. See Section 4.1.4.1.2.1.3 for the list of all fields of the PID segment.

1910

Table 4.3-1: IHE Profile - PID segment

SEQ	LEN	DT	OPT	TBL#	ITEM#	ELEMENT NAME
3	20	CX	R		00106	Patient Identifier List
5	48	XP	R		00108	Patient Name
18	20	CX	C		00121	Patient Account Number

Adapted from the HL7 standard, version 2.3.1

4.3.4.1.2.1.4 PV1 Segment (HL7 v2.3.1)

All of the fields in PV1 segment are optional, except those listed in Table 4.3-2. See Section 4.1.4.1.2.1.4 for the list of all fields of the PV1 segment.

1915

Table 4.3-2: IHE Profile - PV1 Segment

SEQ	LEN	DT	OPT	TBL#	ITEM#	ELEMENT NAME
2	1	IS	R	0004	00132	Patient Class
19	20	CX	C		00149	Visit Number
51	1	IS	C	0326	01226	Visit Indicator

Adapted from the HL7 standard, version 2.3.1

At least one of the fields *PID-18 Patient Account Number* or *PVI-19 Visit Number* shall be valued. Additional requirements for the presence of value in these fields may be documented in regional or national extensions to the IHE Radiology Technical Framework (See RAD TF-4).

1920 Field *PVI-51 Visit Indicator* shall be valued with value “V” if the field *PVI-19 Visit Number* is present. May be omitted otherwise.

4.3.4.1.2.1.5 ORC Segment (HL7 v2.3.1)

All of the fields in ORC segment are optional, except those listed in Table 4.3-3. See Section 4.2.4.1.2.1.4 for the list of all fields of the ORC segment.

1925

Table 4.3-3: IHE Profile - ORC Segment

SEQ	LEN	DT	OPT	TBL#	ITEM #	ELEMENT NAME
1	2	ID	R	0119	00215	Order Control
2	22	EI	C		00216	Placer Order Number
3	22	EI	R		00217	Filler Order Number
4	22	EI	C		00218	Placer Group Number
7	200	TQ	R		00221	Quantity/Timing
9	26	TS	R		00223	Date/Time of Transaction
10	120	XCN	R2		00224	Entered By
12	120	XCN	R		00226	Ordering Provider
14	40	XTN	R2		00228	Call Back Phone Number
17	60	CE	R		00231	Entering Organization

Adapted from the HL7 Standard, version 2.3.1

Field *ORC-1 Order Control* shall have the value of SN in the ORM message and the value NA in the ORR message.

1930 Field *ORC-2 Placer Order Number* shall be valued only in the ORR message and omitted in the ORM message.

Field *ORC-4 Placer Group Number* shall be valued only if the Order Placer and Order Filler utilize concept of Order Groups. Shall not be present otherwise.

4.3.4.1.2.1.6 OBR Segment (HL7 v2.3.1)

All of the fields in OBR segment are optional, except those listed in Table 4.3-4. See Section 4.2.4.1.2.1.5 for the list of all fields of the OBR segment.

1935

Table 4.3-4: IHE Profile - OBR Segment

SEQ	LEN	DT	OPT	TBL#	ITEM #	ELEMENT NAME
2	75	EI	C		00216	Placer Order Number
3	75	EI	R		00217	Filler Order Number
4	200	CE	R		00238	Universal Service ID
12	60	CE	R2		00246	Danger Code
13	300	ST	C		00247	Relevant Clinical Info.
15	300	CM	C	0070	00249	Specimen Source
16	80	XCN	R		00226	Ordering Provider
27	200	TQ	R		00221	Quantity/Timing
30	20	ID	R2	0124	00262	Transportation Mode
31	300	CE	R2		00263	Reason for Study
41	30	ID	R2	0224	01032	Transport Arranged

Adapted from the HL7 Standard, version 2.3.1

1940 Field *OBR-13 Relevant Clinical Info* shall be populated if patient record contains any medical alerts that may be relevant to the order and, in particular, need to be communicated to the technologist.

Field *OBR-15 Specimen Source* holds the laterality (Left/Right) indicator (when used) in the <site modifier (CE)> component. See appendix B for details.

1945 Per the HL7 Standard, IHE recommends that some fields in ORC and OBR segments contain the same information, as described in Section 4.2.4.1.2.1.5.

For the ORR message, all required fields in the OBR segment, except *OBR-2 Placer Order Number*, shall be copied by Order Placer from the ORM message received from the Order Filler. Value of the field *OBR-2 Placer Order Number* shall be generated by the Order Placer.

1950 **4.3.4.1.2.1.7 ERR Segment (HL7 v2.3.1)**

ERR segment in the ORR (Error) message shall be constructed as defined in Section 2.4.3 “Acknowledgement Modes”.

Field *ERR-1 Error code and location* in ORR (Error) shall have the Error code value of 204 (Unknown Key Identifier).

1955 **4.3.4.1.2.2 Message Semantics (HL7 v2.5.1 Option)**

Actors claiming the HL7 v2.5.1 Option shall implement the contents of this section. When an actor claims support for the HL7 v2.5.1 Option the actor is required to support the HL7 v2.5.1 interface requirements described in the referenced volumes and sections. The actor shall still support the HL7 v2.3.1 version of the transactions.

1960 HL7 v2.5.1 Chapter 4 OMG message. Refer to the HL7 Standard for general message semantics. Refer to Section 4.2.4.1.2.2 above for detailed requirements for the OMG message.

HL7 v2.5.1 Chapter 4 ORG message. Refer to HL7 Standard for general message semantics.

See Section 2.4 of this document for MSH and MSA segment definition.

Note: Additional qualifications to the level of specification and HL7 profiling are stated in Section 2.3.

1965 Required segments are listed below. Other segments are optional.

OMG	General Clinical Order Message	Chapter in HL7 v2.5.1
MSH	Message Header	2
PID	Patient Identification	3
PV1	Patient Visit	3
ORC	Common Order	4
TQ1	Timing / Quantity	4
OBR	Order Detail	4

ORG (Success)	General Clinical Order Message Acknowledgment	Chapter in HL7 v2.5.1
MSH	Message Header	2
MSA	Message Acknowledgement	2
ORC	Common Order	4
TQ1	Timing / Quantity	4
OBR	Order Detail	4

ORG (Error)	General Clinical Order Message Acknowledgment	Chapter in HL7 v2.5.1
MSH	Message Header	2
MSA	Message Acknowledgement	2
[{ ERR }]	Error	2

1970 Each message shall be acknowledged by the HL7 ACK message sent by the receiver of the OMG message to its sender. See Section 2.4 for definition and discussion of the ACK message.

4.3.4.1.2.2.1 MSH Segment (HL7 v2.5.1 Option)

The MSH segment shall be constructed as defined in ITI TF-2b:3.30.5.1 MSH – Header Segment. Additional specifications for actors complying with the IHE Radiology Technical Framework are defined in Section 2.4.

1975

Field MSH-9-Message Type shall have three components.

For the order message, the first component shall have a value of OMG; the second component shall have a value of O19; the third component shall have a value of OMG_O19.

1980 For the order acknowledgment message, the first component shall have a value of ORG; the second component shall have value of O20; the third component shall have a value of ORG_O20.

4.3.4.1.2.2.2 MSA Segment (HL7 v2.5.1 Option)

The MSA segment in the ORG (Success) or ORG (Error) message shall be constructed as defined in Section 2.4.

1985 The first component of field *MSA-6-Error condition* in ORG (Error) shall have the error code value of 204 (Unknown Key Identifier).

4.3.4.1.2.2.3 PID Segment (HL7 v2.5.1 Option)

All of the fields in the PID segment are optional, except those listed in Table 4.3-5. See Section 4.1.4.1.2.2.3 for further discussion of the PID segment.

1990

Table 4.3-5: IHE Profile - PID segment

SEQ	LEN	DT	OPT	TBL#	ITEM#	ELEMENT NAME
3	250	CX	R		00106	Patient Identifier List
5	250	XPN	R		00108	Patient Name
18	250	CX	C		00121	Patient Account Number

Adapted from the HL7 standard, version 2.5.1

4.3.4.1.2.2.4 PV1 Segment (HL7 v2.5.1 Option)

All of the fields in the PV1 segment are optional, except those listed in Table 4.3-6. See Section 4.1.4.1.2.2.4 for a full discussion of the PV1 segment.

1995

Table 4.3-6: IHE Profile - PV1 Segment

SEQ	LEN	DT	OPT	TBL#	ITEM#	ELEMENT NAME
2	1	IS	R	0004	00132	Patient Class
19	250	CX	C		00149	Visit Number
51	1	IS	C	0326	01226	Visit Indicator

Adapted from the HL7 standard, version 2.5.1

2000 At least one of the fields *PID-18 Patient Account Number* or *PV1-19 Visit Number* shall be valued. Additional requirements for the presence of value in these fields may be documented in regional or national extensions to the IHE Technical framework (See RAD TF-4). PID-18 and/or PV1-19 is required if it was present in the registration message (trigger event A01, A04 or A05) that is being cancelled by this transaction.

Field *PVI-51 Visit Indicator* shall be valued with value “V” if the field *PVI-19 Visit Number* is valued. It may be omitted otherwise.

4.3.4.1.2.2.5 ORC Segment (HL7 v2.5.1 Option)

2005 All of the fields in ORC segment are optional, except those listed in Table 4.3-7. See Section 4.2.4.1.2.2.4 for the list of all fields of the ORC segment.

Table 4.3-7: IHE Profile - ORC Segment

SEQ	LEN	DT	OPT	TBL#	ITEM #	ELEMENT NAME
1	2	ID	R	0119	00215	Order Control
2	22	EI	C		00216	Placer Order Number
3	22	EI	R		00217	Filler Order Number
4	22	EI	C		00218	Placer Group Number
7	200	TQ	X		00221	Quantity/Timing
9	26	TS	R		00223	Date/Time of Transaction
10	250	XCN	R2		00224	Entered By
12	250	XCN	R		00226	Ordering Provider
14	250	XTN	R2		00228	Call Back Phone Number
17	250	CE	R		00231	Entering Organization

Adapted from the HL7 Standard, version 2.5.1

2010 Field *ORC-1-Order Control* shall have the value of SN for “New Order” or XX for “Change Order” in the OMG message and the value NA in the ORG message.

Field *ORC-2-Placer Order Number* shall be valued only in the ORG message and omitted in the OMG message.

Field *ORC-4-Placer Group Number* shall be valued only if the Order Placer and Order Filler utilize concept of Order Groups. They shall not be present otherwise.

2015 Field *ORC-7-Quantity/Timing* shall not be present. The date and time of the exam shall be carried in field *TQ1-7-Start Date/Time*.

4.3.4.1.2.2.6 TQ1 Segment (HL7 v2.5.1 Option)

2020 Implementations that claim support for the HL7 v2.5.1 Option shall not populate deprecated components *ORC-7.4-Start Date/Time* or *OBR-27.4-Start Date/Time* but instead shall use the TQ1 segment to carry the start date and time of the procedure.

Table 4.3-8: IHE Profile – TQ1 Segment

SEQ	LEN	DT	OPT	TBL#	ITEM #	ELEMENT NAME
1	4	SI	O		01627	Set ID – TQ1
2	20	CQ	O		01628	Quantity
3	540	RPT	O	0335	01629	Repeat Pattern
4	20	TM	O		01630	Explicit Time
5	20	CQ	O		01631	Relative Time and Units
6	20	CQ	O		01632	Service Duration
7	26	TS	R		01633	Start Date/Time
8	26	TS	O		01634	End Date/Time
9	250	CWE	O	0485	01635	Priority
10	250	TX	O		01636	Condition Text
11	250	TX	O	0065	01637	Text Instruction
12	10	ID	C	0427	01638	Conjunction
13	20	CQ	O		01639	Occurrence Duration
14	10	NM	O		01640	Total Occurrences

Adapted from the HL7 Standard, version 2.5.1

Field *TQ1-7-Start Date/Time* shall contain the date and time of the exam.

2025 4.3.4.1.2.2.7 OBR Segment (HL7 v2.5.1 Option)

All of the fields in the OBR segment are optional, except those listed in Table 4.3-9. See Section 4.2.4.1.2.2.6 for the list of all fields of the OBR segment.

Table 4.3-9: IHE Profile - OBR Segment

SEQ	LEN	DT	OPT	TBL#	ITEM #	ELEMENT NAME
2	22	EI	C		00216	Placer Order Number
3	22	EI	R		00217	Filler Order Number
4	250	CE	R		00238	Universal Service ID
12	250	CE	R2		00246	Danger Code
13	300	ST	C		00247	Relevant Clinical Info.
15	300	SPS	X	0070	00249	Specimen Source
16	80	XCN	R		00226	Ordering Provider
27	200	TQ	X		00221	Quantity/Timing
30	20	ID	R2	0124	00262	Transportation Mode
31	250	CE	R2		00263	Reason for Study
41	30	ID	R2	0224	01032	Transport Arranged
46	250	CE	C	0411	01474	Placer Supplemental Service Information

Adapted from the HL7 Standard, version 2.5.1

- 2030 Field *OBR-13-Relevant Clinical Info* shall be populated if patient record contains any medical alerts that may be relevant to the order and, in particular, need to be communicated to the technologist.
- Field *OBR-27-Quantity/Timing* shall not be present. The date and time of the exam shall be carried in field *TQ1-7-Start Date/Time*.
- 2035 Field *OBR-46-Placer Supplemental Service Information* shall contain the laterality (Left/Right) indicator (when used) in the <site modifier (CE)> component. See Appendix B for details.
- Per the HL7 Standard, IHE recommends that some fields in the ORC and OBR segments contain the same information, as described in Section 4.2.4.1.2.2.6.
- 2040 For the ORG message, all required fields in the OBR segment, except *OBR-2-Placer Order Number*, shall be copied by Order Placer from the OMG message received from the Order Filler. The value of the field *OBR-2-Placer Order Number* shall be generated by the Order Placer.

4.3.4.1.2.2.8 ERR Segment (HL7 v2.5.1 Option)

- 2045 The ERR segment in the ORG (Error) message shall be constructed as defined in Section 2.4.
- The first component of Field *ERR-1-Error code* and location in the ORG (Error) message shall have the error code value of 204 (Unknown Key Identifier).

4.3.4.1.3 Expected Actions

- 2050 If the Order Placer accepts and registers order information transmitted from the Order Filler in the Order Management message, it shall assign its unique number to it and convey that number to order Filler in the ORR (Success) message for HL7 v2.3.1 and the ORG (Success) message for HL7 v2.5.1. In turn, the Order Filler shall register received Order Placer number and include it into the subsequent communication of order status with Order Placer, as well as procedure-related information to the Image Manager and Acquisition Modality (see Sections 4.4 and 4.5).
- 2055 If the Order Placer cannot accept order information transmitted from the Order Filler in the Order Management message (e.g., Patient ID does not exist anymore due to a Patient Update-Cancel registration the Order Placer just received), it shall convey the rejection by returning an ORR (Error) message for HL7 v2.3.1 and the ORG (Error) message for HL7 v2.5.1.

4.3.4.2 Filler Order Management - Order Status Update

- 2060 The Order Status Update Message is used by the DSS/Order Filler to notify Order Placer about changes in the status of the order as it is being fulfilled by the DSS/Order Filler.

4.3.4.2.1 Trigger Events

ORM - Department System Scheduler/Order Filler updates an order status (control code = SC). Systems claiming the HL7 v2.5.1 Option shall implement the following:

2065 OMG - Department System Scheduler/Order Filler updates an order status (control code = SC).

4.3.4.2.2 Message Semantics

4.3.4.2.2.1 Message Semantics (HL7 v2.3.1)

HL7 2.3.1 Chapter 4 ORM message. Refer to HL7 Standard for general message semantics. See Section 4.1 of this document for MSH segment definition.

2070 Note: Additional qualifications to the level of specification and HL7 profiling are stated in Section 2. Required segments are listed below. Other segments are optional.

ORM	General Order Message	Chapter in HL7 2.3.1
MSH	Message Header	2
ORC	Common Order	4

4.3.4.2.2.1.1 MSH Segment (HL7 v2.3.1)

MSH segment shall be constructed as defined in the Section 2.4.2.2 “Message Control”.

2075 Field *MSH-9 Message Type* shall have at least two components. The first component shall have a value of “ORM”; the second component shall have value of O01. The third component is optional; however, if present, it shall have a value of ORM_O01.

4.3.4.2.2.1.2 ORC Segment (HL7 v2.3.1)

All of the fields in ORC segment are optional, except those listed in Table 4.3-10. See Section 4.2.4.1.2.1.4 for the list of all fields of the ORC segment.

2080

Table 4.3-10: IHE Profile - ORC Segment

SEQ	LEN	DT	OPT	TBL#	ITEM #	ELEMENT NAME
1	2	ID	R	0119	00215	Order Control
2	22	EI	R		00216	Placer Order Number
3	22	EI	R		00217	Filler Order Number
5	2	ID	R	0038	00219	Order Status

Adapted from the HL7 Standard, version 2.3.1

When an Order Status Update (control code = SC) message is received at the Order Placer, the element ORC-5 “Order Status” will contain the reason for the status change. The reason shall be one of the following:

2085

Order Status Codes

Value	Description
CM	Order is completed
DC	Order was discontinued
IP	Order is in progress

Adapted from the HL7 Standard, version 2.3.1

4.3.4.2.2.2 Message Semantics (HL7 v2.5.1 Option)

2090 Actors claiming the HL7 v2.5.1 Option shall implement the contents of this section. When an actor claims support for the HL7 v2.5.1 Option the actor is required to support the HL7 v2.5.1 interface requirements described in the referenced volumes and sections. The actor shall still support the HL7 v2.3.1 version of the transactions.

HL7 v2.5.1 Chapter 4 OMG message. Refer to HL7 Standard for general message semantics.

2095 See Section 2.4 of this document for MSH segment definition.

Note: Additional qualifications to the level of specification and HL7 profiling are stated in Section 2.

Required segments are listed below. Other segments are optional.

OMG	General Clinical Order Message	Chapter in HL7 v2.5.1
MSH	Message Header	2
ORC	Common Order	4
TQ1	Timing/Quantity	4
OBR	Observation Request	4

4.3.4.2.2.2.1 MSH Segment (HL7 v2.5.1 Option)

2100 The MSH segment shall be constructed as defined in ITI TF-2b:3.30.5.1 MSH – Header Segment. Additional specifications for actors complying with the IHE Radiology Technical Framework are defined in Section 2.4.

Field MSH-9-Message Type shall have three components. The first component shall have a value of OMG; the second component shall have a value of O19; the third component shall have a value of OMG_O19.

2105

4.3.4.2.2.2.2 ORC Segment (HL7 v2.5.1 Option)

All of the fields in the ORC segment are optional, except those listed in Table 4.3-11. See Section 4.2.4.1.2.2.4 for the list of all fields of the ORC segment.

2110

Table 4.3-11: IHE Profile - ORC Segment

SEQ	LEN	DT	OPT	TBL#	ITEM #	ELEMENT NAME
1	2	ID	R	0119	00215	Order Control
2	22	EI	R		00216	Placer Order Number
3	22	EI	R		00217	Filler Order Number
5	2	ID	R	0038	00219	Order Status
7	200	TQ	X		00221	Quantity/Timing

Adapted from the HL7 Standard, version 2.5.1

Deprecated component *ORC-7.4-Start Date/Time* shall not be populated. The TQ1 segment shall be used to carry the start date and time of the procedure.

2115

When an Order Status Update (control code = SC) message is received at the Order Placer, the element *ORC-5-Order Status* will contain the reason for the status change. The reason shall be one of the following:

Order Status Codes

Value	Description
CM	Order is completed
DC	Order was discontinued
IP	Order is in progress

Adapted from the HL7 Standard, version 2.5.1

4.3.4.2.2.3 TQ1 Segment (HL7 v2.5.1 Option)

2120

Deprecated components *ORC-7.4-Start Date/Time* or *OBR-27.4-Start Date/Time* shall not be populated. The TQ1 segment shall be used to carry the start date and time of the procedure.

Table 4.3-12: IHE Profile – TQ1 Segment

SEQ	LEN	DT	OPT	TBL#	ITEM #	ELEMENT NAME
1	4	SI	O		01627	Set ID – TQ1
2	20	CQ	O		01628	Quantity
3	540	RPT	O	0335	01629	Repeat Pattern
4	20	TM	O		01630	Explicit Time
5	20	CQ	O		01631	Relative Time and Units
6	20	CQ	O		01632	Service Duration
7	26	TS	R		01633	Start Date/Time
8	26	TS	O		01634	End Date/Time
9	250	CWE	O	0485	01635	Priority
10	250	TX	O		01636	Condition Text
11	250	TX	O	0065	01637	Text Instruction

SEQ	LEN	DT	OPT	TBL#	ITEM #	ELEMENT NAME
12	10	ID	C	0427	01638	Conjunction
13	20	CQ	O		01639	Occurrence Duration
14	10	NM	O		01640	Total Occurrences

Adapted from the HL7 Standard, version 2.5.1

Field *TQ1-7-Start Date/Time* shall contain the date and time of the exam.

2125 **4.3.4.2.2.4 OBR Segment (HL7 v2.5.1 Option)**

All of the fields in the OBR segment are optional, except those listed in Table 4.3-13. See Section 4.2.4.1.2.2.6 for the list of all fields of the OBR segment.

Table 4.3-13: IHE Profile - OBR Segment

SEQ	LEN	DT	OPT	TBL#	ITEM #	ELEMENT NAME
2	22	EI	C		00216	Placer Order Number
3	22	EI	R		00217	Filler Order Number

Adapted from the HL7 Standard, version 2.5.1

2130 Deprecated component *OBR-27.4-Start Date/Time* shall not be populated. The TQ1 segment shall be used to carry the start date and time of the procedure.

4.3.4.2.3 Expected Actions

DSS/Order Filler shall provide Order Placer with status updates on the order. At least the following events shall be noted:

- 2135
- In Progress – when the first Performed Procedure Step corresponding to the Order has been created;
 - Discontinued – when a cancellation request was received from Order Placer, after an Order has been set to “In-Progress”. A discontinuation applied instead.
 - Completed – when the complete, verified report is available for the given order.

2140 Order Filler shall send at least one Order Status Update message with the Order Status code of “CM”. Determination of exact timing of such a message shall be at the discretion of the Order Filler; however, it may not occur before the final, verified report for all requested procedures within the order is available.

2145 Order Filler shall use the Order Status Update message with the Order Status code of “IP”, to facilitate synchronization of order handling with the Order Placer, for example, to prevent cancellation/discontinuation of an order in progress. In this case, at least one message shall be sent after the Order Filler/Department System Scheduler have processed the first Modality Procedure Step In Progress transaction associated with the order. Note, that Order Placer may

2150 still issue the cancellation request, for example, because of race condition between two messages. In such case, Order Filler shall process cancellation of the order as a discontinuation and return an Order Status Update message with the Order Status Code of “OD”.

Order Status Update message cannot be used to request an action, for example, cancellation or discontinuation of an order.

2155 If an order is being created by the Order Filler (for example, in a case of unidentified patient, see RAD TF-1:4, Order Status Update message shall not be issued until New Order message has been sent by the Order Filler.

4.3.4.3 Filler Order Management - Order Cancelled by the Order Filler

4.3.4.3.1 Trigger Events

2160 ORM – Department System Scheduler/Order Filler cancels the order previously received from Order Placer (control code = OC).

Actors claiming the HL7 v2.5.1 Option shall implement the following trigger event:

OMG – Department System Scheduler/Order Filler cancels the order previously received from Order Placer (control code = OC).

4.3.4.3.2 Message Semantics

2165 **4.3.4.3.2.1 Message Semantics (HL7 v2.3.1)**

HL7 2.3.1 Chapter 4 ORM message. Refer to HL7 standard for general message semantics. Required segments listed below. Other segments are optional.

Note: Additional qualifications to the level of specification and HL7 profiling are stated in Section 2.3.

ORM	General Order Message	Chapter in HL7 2.3.1
MSH	Message Header	2
PID	Patient Identification	3
PV1	Patient Visit	3
ORC	Common Order	4

2170

Each message shall be acknowledged by the HL7 ACK message sent by the receiver of ADT message to its sender. See Section 2.4.3 “Acknowledgement Modes” for definition and discussion of the ACK message.

4.3.4.3.2.1.1 MSH Segment (HL7 v2.3.1)

2175 MSH segment shall be constructed as defined in the Section 2.4.2.2 “Message Control”.

Field *MSH-9 Message Type* shall have at least two components. The first component shall have a value of “ORM”; the second component shall have value of O01. The third component is optional; however, if present, it shall have a value of ORM_O01.

4.3.4.3.2.1.2 PID Segment (HL7 v2.3.1)

2180 All of the fields in PID segment are optional, except those listed in Table 4.3-14. See Section 4.1.4.1.2.1.3 for the list of all fields of the PID segment.

Table 4.3-14: IHE Profile - PID segment

SEQ	LEN	DT	OPT	TBL#	ITEM#	ELEMENT NAME
3	20	CX	R		00106	Patient Identifier List
5	48	XP	R		00108	Patient Name
18	20	CX	C		00121	Patient Account Number

Adapted from the HL7 standard, version 2.3.1

4.3.4.3.2.1.3 PV1 Segment (HL7 v2.3.1)

2185 All of the fields in PV1 segment are optional, except those listed in Table 4.3-15. See Section 4.1.4.1.2.1.4 for the list of all fields of the PV1 segment.

Table 4.3-15: IHE Profile - PV1 Segment

SEQ	LEN	DT	OPT	TBL#	ITEM#	ELEMENT NAME
2	1	IS	R	0004	00132	Patient Class
19	20	CX	C		00149	Visit Number
51	1	IS	C	0326	01226	Visit Indicator

Adapted from the HL7 standard, version 2.3.1

2190 At least one of the fields *PID-18 Patient Account Number* or *PV1-19 Visit Number* shall be valued. Additional requirements for the presence of value in these fields may be documented in regional or national extensions to the IHE Radiology Technical Framework (See RAD TF-4).

Field *PV1-51 Visit Indicator* shall be valued with value “V” if the field *PV1-19 Visit Number* is present. May be omitted otherwise.

4.3.4.3.2.1.4 ORC Segment (HL7 v2.3.1)

2195 All of the fields in ORC segment are optional, except those listed in Table 4.3-16. See Section 4.2.4.1.2.1.4 for the list of all fields of the ORC segment.

Table 4.3-16: IHE Profile - ORC Segment

SEQ	LEN	DT	OPT	TBL#	ITEM #	ELEMENT NAME
1	2	ID	R	0119	00215	Order Control
2	22	EI	R		00216	Placer Order Number
3	22	EI	R		00217	Filler Order Number

Adapted from the HL7 Standard, version 2.3.1

2200 The action to be performed in the ORM message is defined by the Order Control code passed as part of the message. The order control code below shall be supported.

Table 4.3-17: IHE Profile - Supported Order Control Codes

Value	Description	Originator
OC	Order Cancelled	F

4.3.4.3.2.2 Message Semantics (HL7 v2.5.1 Option)

Actors claiming the HL7 v2.5.1 Option shall implement the contents of this section.

2205 HL7 v2.5 Chapter 4 OMG message. Refer to the HL7 standard for general message semantics. Required segments are listed below. Other segments are optional.

Note: Additional qualifications to the level of specification and HL7 profiling are stated in Section 2.3.

OMG	General Clinical Order Message	Chapter in HL7 v2.5.1
MSH	Message Header	2
PID	Patient Identification	3
PV1	Patient Visit	3
ORC	Common Order	4
OBR	Order Detail	4

2210 Each message shall be acknowledged by the HL7 ACK message sent by the receiver of the OMG message to its sender. See Section 2.4 for definition and discussion of the ACK message.

4.3.4.3.2.2.1 MSH Segment (HL7 v2.5.1 Option)

The MSH segment shall be constructed as defined in ITI TF-2b:3.30.5.1 MSH – Header Segment. Additional specifications for actors complying with the IHE Radiology Technical Framework are defined in Section 2.4.

2215

Field *MSH-9-Message Type* shall have three components. The first component shall have a value of OMG; the second component shall have a value of O19; the third component shall have a value of OMG_O19.

4.3.4.3.2.2 PID Segment (HL7 v2.5.1 Option)

2220 All of the fields in the PID segment are optional, except those listed in Table 4.3-18. See Section 4.1.4.1.2.2.3 for further discussion of the PID segment.

Table 4.3-18: IHE Profile - PID segment

SEQ	LEN	DT	OPT	TBL#	ITEM#	ELEMENT NAME
3	250	CX	R		00106	Patient Identifier List
5	250	XP	R		00108	Patient Name
18	250	CX	C		00121	Patient Account Number

Adapted from the HL7 standard, version 2.5.1

4.3.4.3.2.3 PV1 Segment (HL7 v2.5.1 Option)

2225 All of the fields in the PV1 segment are optional, except those listed in Table 4.3-19. See Section 4.1.4.1.2.2.4 for a full discussion of the PV1 segment.

Table 4.3-19: IHE Profile - PV1 Segment

SEQ	LEN	DT	OPT	TBL#	ITEM#	ELEMENT NAME
2	1	IS	R	0004	00132	Patient Class
19	250	CX	C		00149	Visit Number
51	1	IS	C	0326	01226	Visit Indicator

Adapted from the HL7 standard, version 2.5.1

2230 At least one of the fields *PID-18-Patient Account Number* or *PV1-19-Visit Number* shall be valued. Additional requirements for the presence of value in these fields may be documented in regional or national extensions to the IHE Radiology Technical Framework (See RAD TF-4).

Field *PV1-51-Visit Indicator* shall be valued with value “V” if the field *PV1-19 Visit Number* is valued. It may be omitted otherwise.

4.3.4.3.2.4 ORC Segment (HL7 v2.5.1 Option)

2235 All of the fields in the ORC segment are optional, except those listed in Table 4.3-20. See Section 4.2.4.1.2.2.4 for the list of all fields of the ORC segment.

Table 4.3-20: IHE Profile - ORC Segment

SEQ	LEN	DT	OPT	TBL#	ITEM #	ELEMENT NAME
1	2	ID	R	0119	00215	Order Control
2	22	EI	R		00216	Placer Order Number
3	22	EI	R		00217	Filler Order Number

Adapted from the HL7 Standard, version 2.5.1

2240 The action to be performed in the OMG message is defined by the Order Control code passed as part of the message. The order control code below shall be supported.

Table 4.3-21: IHE Profile - Supported Order Control Codes

Value	Description	Originator
OC	Order Cancelled	F

4.3.4.3.2.5 OBR Segment (HL7 v2.5.1 Option)

All of the fields in the OBR segment are optional, except those listed in Table 4.3-22. See Section 4.2.4.1.2.2.6 for the list of all fields of the OBR segment.

2245

Table 4.3-22: IHE Profile - OBR Segment

SEQ	LEN	DT	OPT	TBL#	ITEM #	ELEMENT NAME
2	22	EI	C		00216	Placer Order Number
3	22	EI	R		00217	Filler Order Number

Adapted from the HL7 Standard, version 2.5.1

4.3.4.3.3 Expected Actions

2250 After receiving the ORM message (or OMG message if claiming the HL7 v2.5.1 Option) with the control code OC, Order Placer shall process the order the same way as if it was cancelled/discontinued by the Order Placer.

If DSS/Order Filler has already scheduled the procedures corresponding to the order, it shall perform transaction RAD-13 Procedure Update (see Section 4.13) to notify the Image Manager of order cancellation.

2255 **4.4 Procedure Scheduled [RAD-4]**

This section corresponds to Transaction RAD-4 of the IHE Technical Framework. Transaction RAD-4 is used by the Department System Scheduler/Order Filler, Image Manager and Report Manager Actors.

4.4.1 Scope

2260 This transaction specifies a message from the Department System Scheduler/Order Filler to the Image Manager and the Report Manager notifying them that a procedure has been scheduled.

Scheduling does not necessarily mean precise time assignment for the particular procedures. For example, inpatient procedures are not necessarily scheduled for a specific time slot, but rather for “today” or “as soon as possible”. However, the Department System Scheduler/Order Filler shall handle all orders in such a way that it is capable of informing the Image Manager and the Report Manager about procedure timing and resources used to perform a procedure. It must provide the date and time when the procedure is to be performed, although precision of the time portion of that information is allowed to be implementation dependent.

2270 This message serves as a trigger event for the Image Manager and the Report Manager, informing it to obtain necessary information and apply rules to ensure the availability of relevant information to the end user. The Image Manager and the Report Manager may need the information to create the Requested Procedure context for its purposes. The Procedure Scheduled transaction includes the initial scheduling message. The Procedure Scheduled message is also used to provide additional information from the Department System Scheduler to the Image Manager and the Report Manager for unscheduled cases. In the event that a procedure is performed prior to ordering (as in some of the use cases in RAD TF-1: 4.4), this message is used “after the fact” for the Department System Scheduler to inform the Image Manager and the Report Manager of critical information such as Accession Number and Requested Procedure ID. This is described in more detail within this section.

2280 The Department System Scheduler/Order Filler will need to communicate with multiple Image Managers. The Department System Scheduler/Order Filler shall broadcast these scheduling messages to all Image Managers and the Report Manager. An Image Manager shall be able to receive and process these messages with the understanding that the images and MPPS events for these procedures may be sent to a different Image Manager.

2285 The organization operating the DSS/OF and the Image Manager/Image Archive is responsible for synchronizing Procedure and Protocol Codes between all the systems that use such codes. IHE does not yet define a common mechanism for code synchronization or access.

4.4.2 Use Case Roles

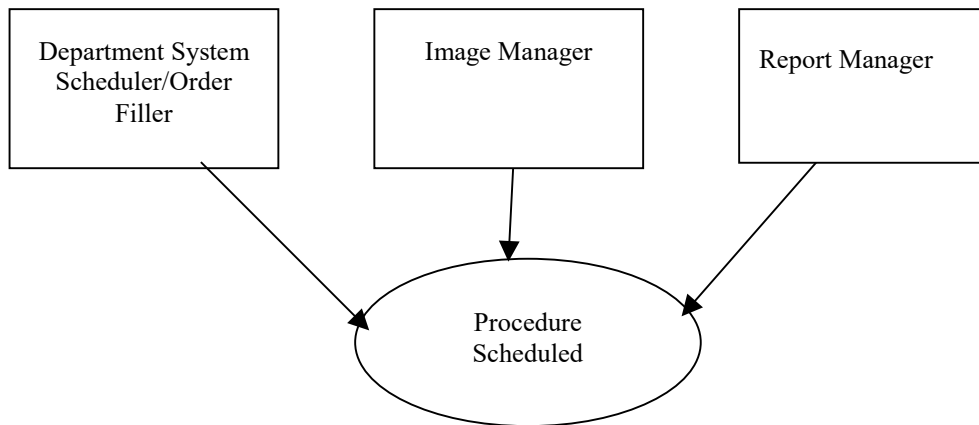

2290

Actor: Department System Scheduler/Order Filler

Role: Enters, modifies and stores information about patients, receives orders, schedules Procedures (exams), modifies information about them (rescheduling, cancellations, code changes, etc.).

2295

Actor: Image Manager

Role: Receives information about Patients, Orders, and schedules, and uses this information to assist in image management.

Actor: Report Manager

Role: Receives information about Patients, Orders, and schedules, and uses this information to assist in Report management.

2300

4.4.3 Referenced Standards

HL7 v2.3.1 Chapters 2-4

HL7 v2.5.1 Chapters 2-4

4.4.4 Interaction Diagram

2305

The following diagram illustrates interactions between actors within systems implementing HL7 v2.3.1:

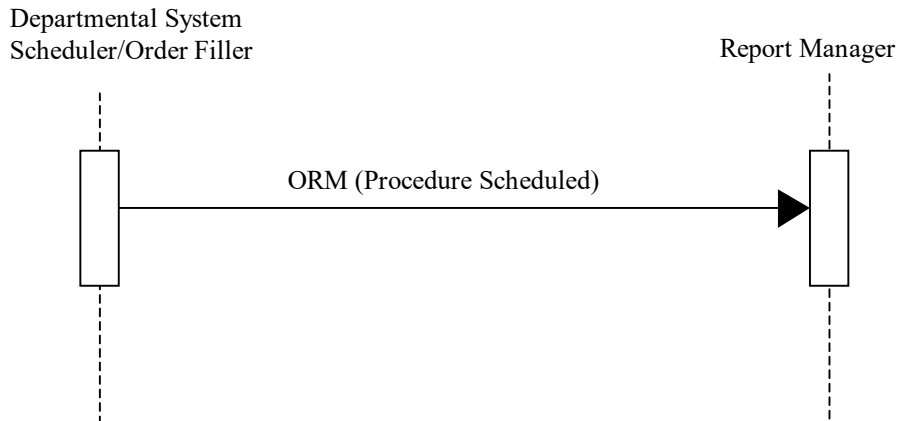
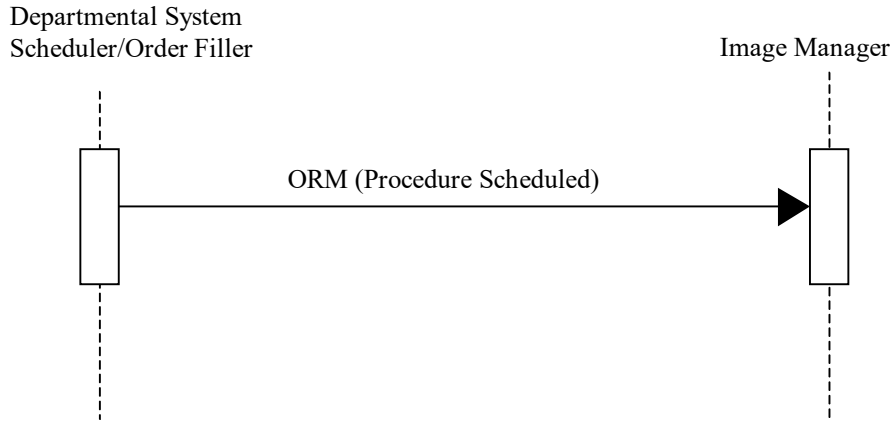

2310 The following diagram illustrates interactions between actors within systems implementing HL7 v2.5.1:

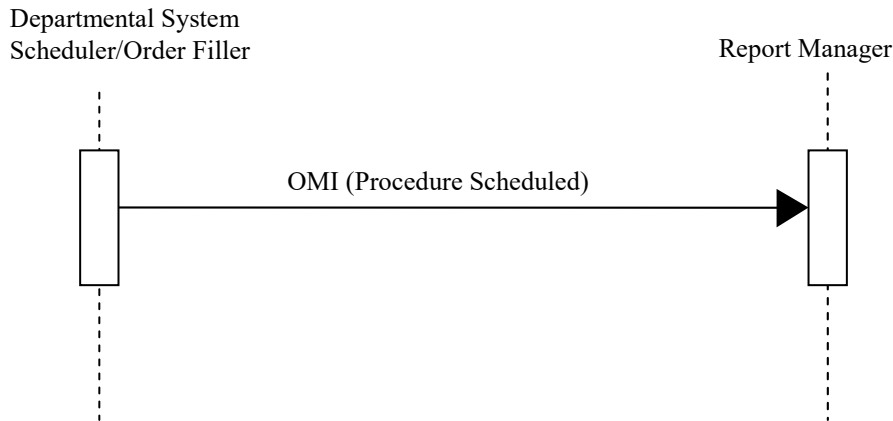
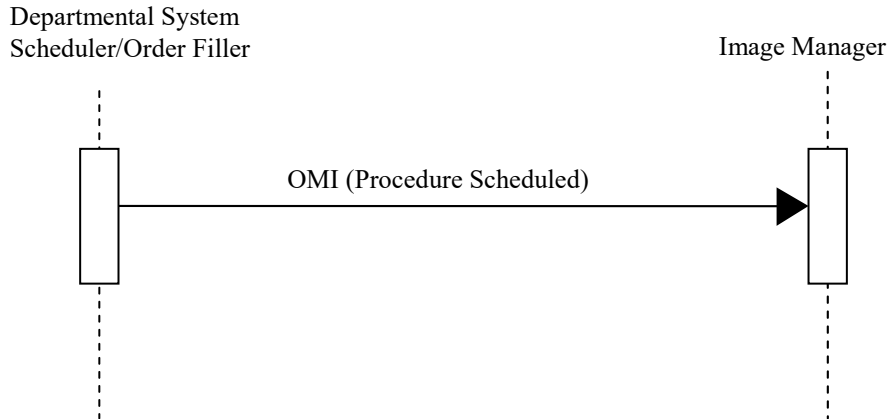

4.4.4.1 Procedure Scheduled Message

2315 4.4.4.1.1 Trigger Events

The Department System Scheduler/Order Filler determines procedures which need to be performed to fill the order, what Procedure Steps need to be performed for each Procedure, and timing and necessary resources.

2320 Note: This transaction shall be used the first time a particular Study Instance UID is sent from the Department System Scheduler/Order Filler to the Image Manager or Report Manager. If the Study Instance UID has been sent previously, then Procedure Updated [RAD-13] shall be used.

4.4.4.1.2 Message Semantics

4.4.4.1.2.1 Message Semantics (HL7 v2.3.1)

2325 The Department System Scheduler/Order Filler uses an ORM message to convey necessary procedure and scheduling information.

2330 The Procedure Scheduled Transaction will perform the additional task of providing Patient Demographic information to the Image Manager and the Report Manager. The Image Manager and the Report Manager do not receive all Patient Registration events from the ADT System because it is not necessary for the Image Manager and Report Manager to be aware of all patients in the enterprise (since most will never have an imaging procedure). The Image Manager and the Report Manager shall obtain the Patient Demographic information from the Procedure Schedule ORM, specifically the PID and PV1 segments. For this reason, the Department System Scheduler/Order Filler must complete these segments as described in Section 4.1, Patient Registration.

2335 Note: Additional information regarding HL7 conventions, profiling, and implementation considerations is given in Section 2.3.

The segments listed below are required. All other segments are optional.

ORM	General Order Message	Chapter in HL7 2.3
MSH	Message Header	2
PID	Patient Identification	3
PV1	Patient Visit	3
{ORC	Common Order	4
OBR}	Order Detail	4
ZDS	Additional identification information (custom for IHE)	

2340 Each message shall be acknowledged by the HL7 ACK message sent by the receiver of the ORM message to its sender. See Section 2.4.3 “Acknowledgement Modes” for definition and discussion of the ACK message.

4.4.4.1.2.1.1 MSH Segment (HL7 v2.3.1)

MSH segment shall be constructed as defined in the Section 2.4.2.2 “Message Control”.

2345 Field *MSH-9 Message Type* shall have at least two components. The first component shall have a value of “ORM”; the second component shall have value of O01. The third component is optional; however, if present, it shall have a value of ORM_O01.

4.4.4.1.2.1.2 PID Segment (HL7 v2.3.1)

2350 All of the fields in PID segment are optional, except those listed in Table 4.4-1. See Section 4.1.4.1.2.1.3 for the list of all fields of the PID segment.

Table 4.4-1: IHE Profile - PID segment

SEQ	LEN	DT	OPT	TBL#	ITEM#	ELEMENT NAME
3	20	CX	R		00106	Patient Identifier List
5	48	XP	R		00108	Patient Name
7	26	TS	R2		00110	Date/Time of Birth
8	1	IS	R	0001	00111	Sex
10	80	CE	R2	0005	00113	Race
11	106	XAD	R2		00114	Patient Address
18	20	CX	C		00121	Patient Account Number

Adapted from the HL7 standard, version 2.3.1

2355 Every system participating in the information exchange using HL7 shall use the field PID-3 Patient Identifier List to convey the Patient ID uniquely identifying the patient, typically at the Master Patient Index. If the Master Patient Index is not available, the ID initially assigned by the ADT/Registration System may be conveyed in this field (IHE Technical Framework currently does not provide for the use of an MPI). See appendix B and appendix D for further discussion of the use of PID-3 in transactions and its mapping from HL7 messages to DICOM Patient ID (0010,0020).

2360 **4.4.4.1.2.1.3 PV1 Segment (HL7 v2.3.1)**

All of the fields in PV1 segment are optional, except those listed in Table 4.4-2. See Section 4.1.4.1.2.1.4 for the list of all fields of the PV1 segment.

Table 4.4-2: IHE Profile - PV1 Segment

SEQ	LEN	DT	OPT	TBL#	ITEM#	ELEMENT NAME
2	1	IS	R	0004	00132	Patient Class
3	80	PL	C		00133	Assigned Patient Location
7	60	XCN	C	0010	00137	Attending Doctor
8	60	XCN	C	0010	00138	Referring Doctor
9	60	XCN	R2	0010	00139	Consulting Doctor
10	3	IS	C	0069	00140	Hospital Service
15	2	IS	C	0009	00145	Ambulatory Status
17	60	XCN	C	0010	00147	Admitting Doctor
19	20	CX	C		00149	Visit Number
51	1	IS	C	0326	01226	Visit Indicator

Adapted from the HL7 standard, version 2.3.1

2365 At least one of the fields *PID-18 Patient Account Number* or *PV1-19 Visit Number* shall be valued. Additional requirements for the presence of value in these fields may be documented in regional or national extensions to the IHE Radiology Technical Framework (See RAD TF-4).

2370 Fields *PVI-3 Assigned Patient Location*, *PVI-7 Attending Doctor*, *PVI-10 Hospital Service*, *PVI-17 Admitting Doctor* shall be valued only when a procedure is scheduled for the admitted in-patient.

Field *PVI-8 Referring Doctor* shall be valued when a procedure is scheduled for an outpatient. May be omitted otherwise.

Field *PVI-15 Ambulatory Status* shall be valued when patient status indicates certain conditions such as pregnancy. May be omitted if none of the defined statuses are applicable to a patient.

2375 Field *PVI-51 Visit Indicator* shall be valued with value “V” if the field *PVI-19 Visit Number* is present. May be omitted otherwise.

4.4.4.1.2.1.4 ORC Segment (HL7 v2.3.1)

All of the fields in ORC segment are optional, except those listed in Table 4.4-3. See Section 4.2.4.1.2.1.4 for the list of all fields of the ORC segment

2380

Table 4.4-3: IHE Profile - ORC Segment

SEQ	LEN	DT	OPT	TBL#	ITEM #	ELEMENT NAME
1	2	ID	R	0119	00215	Order Control
2	22	EI	R2		00216	Placer Order Number
3	22	EI	R		00217	Filler Order Number
5	2	ID	R	0038	00219	Order Status
7	200	TQ	R		00221	Quantity/Timing
10	120	XCN	R2		00224	Entered By
12	120	XCN	R2		00226	Ordering Provider
13	80	PL	R2		00227	Enterer’s Location
14	40	XTN	R2		00228	Call Back Phone Number
17	60	CE	R2		00231	Entering Organization

Adapted from the HL7 Standard, version 2.3.1

2385 The Department System Scheduler uses the ORM message in a context different from the context existing between Order Placer and Order Filler. The Department System Scheduler/Order Filler shall send as many ORM messages as there are Requested Procedures identified to fill a single order. Each ORM message shall contain as many ORC/OBR pairs as there are Protocol Codes in all Scheduled Procedure Steps for that Requested Procedure.

2390 It is actually common for the Department System Scheduler/Order Filler to receive a single ORM from the Order Placer system, but choose to expand that order into multiple Requested Procedures, therefore sending multiple ORMs to the Image Manager or Report Manager. Taking this into account, the Department System Scheduler will consider itself an “order placer” in relation to the Image Manager or Report Manager.

Required fields in the ORC segment shall be filled by the Department System Scheduler as given in the following table.

Table 4.4-4: DSS Mappings of the ORC Segment

Element Name	Seq.	Element Shall Contain:	Notes
Order Control Code	ORC-1	“NW”	New order
Placer Order Number	ORC-2	Placer Order Number received from Order Placer	In the event that the Order Filler places the order, the Order Filler shall not send the scheduling ORM message until it has received the Placer Order Number from the Order Placer (through an ORR message). If the Order Filler schedules a procedure for unidentified patient without an order (see case 4), this field shall be empty.
Filler Order Number	ORC-3	Filler Order Number	Number generated internally by the Department System Scheduler
Order Status	ORC-5	“SC”	Scheduled
Quantity/Timing	ORC-7	Date and time of the Scheduled Procedure Step (in the fourth component)	

2395

4.4.4.1.2.1.5 OBR Segment (HL7 v2.3.1)

All of the fields in OBR segment are optional, except those listed in Table 4.4-5. See Section 4.2.4.1.2.1.5 for the list of all fields of the OBR segment.

Table 4.4-5: IHE Profile - OBR Segment

SEQ	LEN	DT	OPT	TBL#	ITEM #	ELEMENT NAME
1	4	SI	R		00237	Set ID – OBR
2	22	EI	R2		00216	Placer Order Number
3	22	EI	R		00217	Filler Order Number
4	200	CE	R		00238	Universal Service ID
5	2	ID	R2		00239	Priority
12	60	CE	R2		00246	Danger Code
13	300	ST	R2		00247	Relevant Clinical Info.
15	300	CM	C	0070	00249	Specimen Source
16	120	XCN	R2		00226	Ordering Provider
17	40	XTN	R2		00250	Order Callback Phone Number
18	60	ST	R		00251	Placer field 1

SEQ	LEN	DT	OPT	TBL#	ITEM #	ELEMENT NAME
19	60	ST	R		00252	Placer field 2
20	60	ST	R		00253	Filler Field 1
24	10	ID	R	0074	00257	Diagnostic Serv Sect ID
27	200	TQ	R		00221	Quantity/Timing
30	20	ID	R2	0124	00262	Transportation Mode
31	300	CE	R2		00263	Reason for Study
44	80	CE	O	0088	00393	Procedure Code

2400

Adapted from the HL7 Standard, version 2.3.1

Field *OBR-15 Specimen Source* holds the laterality (Left/Right) indicator (when used) in the <site modifier (CE)> component. See Appendix B for details.

Per the HL7 Standard, IHE recommends that some fields in ORC and OBR segments contain the same information, as described in Section 4.2.4.1.2.1.5.

2405

Required fields in the OBR segment that are not identical to those from the ORC segment shall be filled by the Department System Scheduler as defined in the following table.

Table 4.4-6: DSS mappings of the OBR Segment

Element Name	Seq.	Shall Contain:	Notes
Placer Field 1	OBR-18	Accession Number	Length of the value in this field shall not exceed 16 characters
Placer Field 2	OBR-19	Requested Procedure ID	All OBR segments within a single ORM message shall have the same value in this field.
Filler Field 1	OBR-20	Scheduled Procedure Step ID	If a Scheduled Procedure Step has multiple Protocol Codes associated with it, several ORC segments within a single ORM message may have the same value in this field.
Universal Service ID	OBR-4	Both the Universal Service ID of the Order and a Scheduled Protocol Code of the Scheduled Procedure Step (see OBR-20).	Components 1-3 of OBR-4 shall be copied by the Order Filler from the components 1-3 of OBR-4 it obtains from the ORM message (OBR segment) conveyed to it by the Order Placer. Components 1-3 of OBR-4 in all OBR segments of an ORM message shall have the same value. Components 4-6 shall be filled with the Scheduled Protocol Code. (See Section 4.4.4.1.2.1.4 for multiple Scheduled Protocol Codes). The related Requested Procedure Code/Description is sent in OBR-44.
Specimen Source	OBR-15	The fifth component, Site Modifier, shall be used for the L/R indicator. The L/R value shall be appended to the Requested Procedure Description (0032,1060).	This element shall only be used if the coding scheme that is employed does not contain laterality within the coding scheme itself. If laterality is inherent in the coding scheme, this element shall not be sent.
Diagnostic Service Section ID	OBR-24	DICOM Modality	The Modality attribute of DICOM consists of Defined Terms that shall be used in this element.
Procedure Code	OBR-44	Requested Procedure Code and Requested Procedure Description.	Components 1-3 shall contain the Requested Procedure Code for this ORM message. Optionally, component 5 may contain the Requested Procedure Description. As the Order Filler may expand a single order into multiple Requested Procedures, multiple ORM messages may be sent for a single Order (with the same value for Components 1-3 of OBR-4).

2410 A custom ZDS Segment is defined to convey information generated by the Order Filler and not currently defined in the HL7 standard and is given in the following table.

Table 4.4-7: IHE Profile - ZDS Segment

SEQ	LEN	DT	OPT	TBL#	ITEM#	ELEMENT NAME
1	200	RP	R		Z0001	Study Instance UID

Components of the Study Instance UID field shall be encoded as given in the Table 4.4-8.

2415

Table 4.4-8: Z Segment Study Instance UID Element Components

Component Number	Component Name	Shall Contain:
1	Reference Pointer	DICOM compliant Study Instance UID value
2	Application ID	Implementation specific
3	Type of Data	“Application”
4	Subtype	“DICOM”

4.4.4.1.2.2 Message Semantics (HL7 v2.5.1 Option)

Actors claiming the HL7 v2.5.1 Option shall implement the contents of this section. When an actor claims support for the HL7 v2.5.1 Option the actor is required to support the HL7 v2.5.1 interface requirements described in the referenced volumes and sections. The actor shall still support the HL7 v2.3.1 version of the transactions.

2420

The Department System Scheduler/Order Filler uses an OMI message to convey necessary procedure and scheduling information.

The Procedure Scheduled Transaction will perform the additional task of providing Patient Demographic information to the Image Manager and the Report Manager. The Image Manager and the Report Manager do not receive all Patient Registration events from the ADT System because it is not necessary for the Image Manager and Report Manager to be aware of all patients in the enterprise (since most will never have an imaging procedure). The Image Manager and the Report Manager shall obtain the Patient Demographic information from the Procedure Scheduled OMI message, specifically the PID, PV1 and ROL segments. For this reason, the Department System Scheduler/Order Filler must complete these segments as described in Section 4.1, Patient Registration.

2425

2430

Note: Additional information regarding HL7 conventions, profiling, and implementation considerations is given in Section 2.3.

The segments listed below are required. All other segments are optional.

2435

OMI	Imaging Order Message	Chapter in HL7 v2.5.1
MSH	Message Header	2
PID	Patient Identification	3
PV1	Patient Visit	3
{ ROL }	Role	15
{ ORC }	Common Order	4
TQ1	Timing / Quantity	4

OMI	Imaging Order Message	Chapter in HL7 v2.5.1
OBR	Order Detail	4
{ IPC }	Imaging Procedure Control	4

Each message shall be acknowledged by the HL7 ACK message sent by the receiver of the ORM message to its sender. See Section 2.4.4.3 “Acknowledgement Modes” for definition and discussion of the ACK message.

4.4.4.1.2.2.1 MSH Segment (HL7 v2.5.1 Option)

2440 The MSH segment shall be constructed as defined in ITI TF-2b:3.30.5.1 MSH – Header Segment. Additional specifications for actors complying with the IHE Radiology Technical Framework are in Section 2.4.

2445 Field MSH-9-Message Type shall have three components. The first component shall have a value of OMI; the second component shall have a value of O23; the third component shall have a value of OMI_O23.

4.4.4.1.2.2.2 PID Segment (HL7 v2.5.1 Option)

All of the fields in the PID segment are optional, except those listed in Table 4.4-9. See Section 4.1.4.1.2.2.3 for further discussion of the PID segment.

Table 4.4-9: IHE Profile - PID segment

SEQ	LEN	DT	OPT	TBL#	ITEM#	ELEMENT NAME
3	250	CX	R		00106	Patient Identifier List
5	250	XPN	R		00108	Patient Name
7	26	TS	R2		00110	Date/Time of Birth
8	1	IS	R	0001	00111	Sex
10	250	CE	R2	0005	00113	Race
11	250	XAD	R2		00114	Patient Address
18	250	CX	C		00121	Patient Account Number

2450 *Adapted from the HL7 standard, version 2.5.1*

2455 Every system participating in the information exchange using HL7 shall use field *PID-3-Patient Identifier List* to convey the Patient ID uniquely identifying the patient, typically at the master patient index. If the master patient index is not available, the ID initially assigned by the ADT/Registration System may be conveyed in this field (IHE Technical Framework currently does not provide for the use of an MPI). See Appendix B and Appendix D for further discussion of the use of PID-3 in transactions and its mapping from HL7 messages to DICOM Patient ID (0010,0020).

4.4.4.1.2.2.3 PV1 Segment (HL7 v2.5.1 Option)

2460 All of the fields in the PV1 segment are optional, except those listed in Table 4.4-10. See Section 4.1.4.1.2.2.4 for a full discussion of the PV1 segment.

Table 4.4-10: IHE Profile - PV1 Segment

SEQ	LEN	DT	OPT	TBL#	ITEM#	ELEMENT NAME
2	1	IS	R	0004	00132	Patient Class
3	80	PL	C		00133	Assigned Patient Location
7	60	XCN	C	0010	00137	Attending Doctor
8	60	XCN	C	0010	00138	Referring Doctor
9	60	XCN	X	0010	00139	Consulting Doctor
10	3	IS	C	0069	00140	Hospital Service
15	2	IS	C	0009	00145	Ambulatory Status
17	60	XCN	C	0010	00147	Admitting Doctor
19	20	CX	C		00149	Visit Number
51	1	IS	C	0326	01226	Visit Indicator

Adapted from the HL7 standard, version 2.5.1

2465 At least one of the fields *PID-18-Patient Account Number* or *PV1-19-Visit Number* shall be valued. Additional requirements for the presence of value in these fields may be documented in regional or national extensions to the IHE Radiology Technical Framework (See RAD TF-4).

Fields *PV1-3-Assigned Patient Location*, *PV1-7-Attending Doctor*, *PV1-10-Hospital Service*, *PV1-17-Admitting Doctor* shall be valued only when a procedure is scheduled for an admitted in-patient.

2470 Field *PV1-8-Referring Doctor* shall be valued when registering an outpatient (*MSH-9- Message Type* is ADT^A04^ADT_A01) or when pre-registering a patient (*MSH-9-Message Type* is ADT^A05^ADT_A05).

The PV1 segment shall be followed for each of the attending doctor, admitting doctor, and referring doctor, by a ROL segment.

2475 Field *PV1-9-Consulting Doctor* shall not be present. The consulting doctor(s) are required and entirely described in the ROL segments.

Field *PV1-15-Ambulatory Status* shall be valued when patient status indicates certain conditions such as pregnancy. It may be omitted if none of the defined statuses are applicable to a patient.

- Field *PV1-51-Visit Indicator* shall be valued with value "V" if the field *PV1-19-Visit Number* is valued. It may be omitted otherwise.

2480 **4.4.4.1.2.2.4 ROL Segment (HL7 v2.5.1 Option)**

One ROL segment shall be included for each attending doctor, admitting doctor, referring doctor and consulting doctor, if any. Note that some Provider Role codes in the ROL Segment use the word "Provider" rather than "Doctor".

The ROL Segment shall be constructed as defined in ITI TF-2b:3.30.5.6 ROL- Role Segment.

2485 **4.4.4.1.2.2.5 ORC Segment (HL7 v2.5.1 Option)**

All of the fields in the ORC segment are optional, except those listed in Table 4.4-11. See Section 4.2.4.1.2.2.4 for the list of all fields of the ORC segment.

Table 4.4-11: IHE Profile - ORC Segment

SEQ	LEN	DT	OPT	TBL#	ITEM #	ELEMENT NAME
1	2	ID	R	0119	00215	Order Control
2	22	EI	R2		00216	Placer Order Number
3	22	EI	R		00217	Filler Order Number
5	2	ID	R	0038	00219	Order Status
7	200	TQ	X		00221	Quantity/Timing
10	250	XCN	R2		00224	Entered By
12	250	XCN	R2		00226	Ordering Provider
13	80	PL	R2		00227	Enterer's Location
14	250	XTN	R2		00228	Call Back Phone Number
17	250	CE	R2		00231	Entering Organization

Adapted from the HL7 Standard, version 2.5.1

2490 The Department System Scheduler uses the OMI message in a context different from the context existing between Order Placer and Order Filler. The Department System Scheduler/Order Filler shall send as many OMI messages as there are Requested Procedures identified to fill a single order.

2495 It is actually common for the Department System Scheduler/Order Filler to receive a single ORM from the Order Placer system, but choose to expand that order into multiple Requested Procedures, therefore sending multiple OMIs to the Image Manager or Report Manager. Taking this into account, the Department System Scheduler will consider itself an “order placer” in relation to the Image Manager or Report Manager.

2500 Required fields in the ORC segment shall be filled by the Department System Scheduler as given in the following table.

Table 4.4-12: DSS Mappings of the ORC Segment

Element Name	Seq.	Element Shall Contain:	Notes
Order Control Code	ORC-1	“NW”	New order

Element Name	Seq.	Element Shall Contain:	Notes
Placer Order Number	ORC-2	Placer Order Number received from Order Placer	In the event that the Order Filler places the order, the Order Filler shall not send the scheduling OMI message until it has received the Placer Order Number from the Order Placer (through an ORG message). If the Order Filler schedules a procedure for unidentified patient without an order (see case 4), this field shall be empty.
Filler Order Number	ORC-3	Filler Order Number	Number generated internally by the Department System Scheduler
Order Status	ORC-5	“SC”	Scheduled
Quantity/Timing	ORC-7	Shall not be valued: Date and time of the Scheduled Procedure Step shall be carried in the immediately following TQ1 segment.	

4.4.4.1.2.2.6 TQ1 Segment (HL7 v2.5.1 Option)

Deprecated components ORC-7.4-Start Date/Time or OBR-27.4-Start Date/Time shall not be populated but instead the TQ1 segment shall be used to carry the start date and time of the procedure.

2505

Table 4.4-13: IHE Profile – TQ1 Segment

SEQ	LEN	DT	OPT	TBL#	ITEM #	ELEMENT NAME
1	4	SI	O		01627	Set ID – TQ1
2	20	CQ	O		01628	Quantity
3	540	RPT	O	0335	01629	Repeat Pattern
4	20	TM	O		01630	Explicit Time
5	20	CQ	O		01631	Relative Time and Units
6	20	CQ	O		01632	Service Duration
7	26	TS	R		01633	Start Date/Time
8	26	TS	O		01634	End Date/Time
9	250	CWE	O	0485	01635	Priority
10	250	TX	O		01636	Condition Text
11	250	TX	O	0065	01637	Text Instruction
12	10	ID	C	0427	01638	Conjunction
13	20	CQ	O		01639	Occurrence Duration
14	10	NM	O		01640	Total Occurrences

Adapted from the HL7 Standard, version 2.5.1

Field *TQ1-7-Start Date/Time* shall contain the date and time of the exam.

4.4.4.1.2.2.7 OBR Segment (HL7 v2.5.1 Option)

2510 All of the fields in the OBR segment are optional, except those listed in Table 4.4-14. See Section 4.2.4.1.2.2.6 for the list of all fields of the OBR segment.

Table 4.4-14: IHE Profile - OBR Segment

SEQ	LEN	DT	OPT	TBL#	ITEM#	ELEMENT NAME
1	4	SI	R		00237	Set ID – OBR
2	22	EI	R2		00216	Placer Order Number
3	22	EI	R		00217	Filler Order Number
4	200	CE	R		00238	Universal Service ID
5	2	ID	R2		00239	Priority
12	60	CE	R2		00246	Danger Code
13	300	ST	R2		00247	Relevant Clinical Info.
16	120	XCN	R2		00226	Ordering Provider
17	40	XTN	R2		00250	Order Callback Phone Number
27	200	TQ	X		00221	Quantity/Timing
30	20	ID	R2	0124	00262	Transportation Mode
31	300	CE	R2		00263	Reason for Study
46	250	CE	R2	0411	01474	Placer Supplemental Service Information

Adapted from the HL7 Standard, version 2.5.1

2515 One ORC-TQ1-OBR-IPC segment group shall correspond to each Requested Procedure. If a Requested Procedure is comprised of multiple Scheduled Procedure Steps and/or if a Scheduled Procedure Step is comprised of multiple Protocol Codes, each applicable Scheduled Procedure Step / Protocol Code combination shall be included in a separate IPC segment following the ORC-TQ1-OBR segment group that contains the Requested Procedure.

- 2520
- Field OBR-46-Placer Supplemental Service Information shall contain the laterality (Left/Right) indicator (when applicable). Field OBR-15-Specimen Source, which had formerly been adapted for this use by the IHE Technical Framework and has been deprecated in HL7 Version 2.5.1, shall not be present. See Appendix B for details.
- 2525
- Per the HL7 Standard, IHE recommends that some fields in the ORC and OBR segments contain the same information, as described in Section 4.2.4.1.2.6.6.
 - Non-optional fields in the OBR segment that are not identical to those from the ORC segment shall be filled by the Department System Scheduler as defined in the following table.

2530

Table 4.4-15: DSS mappings of the OBR Segment (HL7 v2.5.1 Option)

Element Name	Seq.	Shall Contain:	Notes
Universal Service ID	OBR-4	The Universal Service ID of the Order.	Components 1-3 of OBR-4 shall be copied by the Order Filler from the components 1-3 of OBR-4 it obtains from the ORM message (OBR segment) conveyed to it by the Order Placer. Components 1-3 of OBR-4 in all OBR segments of an OMI or legacy ORM message shall have the same value. The related Requested Procedure Code/Description are sent in OBR-44. As the Order Filler may expand a single order into multiple Requested Procedures, multiple OMI messages may be sent for a single Order (with the same value for Components 1-3 of OBR-4).
Procedure Code	OBR-44	Requested Procedure Code and Requested Procedure Description.	Components 1-3 shall contain the Requested Procedure Code for this OMI message. Optionally, component 5 may contain the Requested Procedure Description.
Placer Supplemental Service Information	OBR-46	This element shall be used for the L/R (laterality) indicator, if applicable. The L/R value shall be appended to the Requested Procedure Description (0032,1060).	This element shall only be used if the coding scheme that is employed does not contain laterality within the coding scheme itself. If laterality is inherent in the coding scheme, this element shall not be sent.

4.4.4.1.2.2.8 IPC Segment (HL7 v2.5.1 Option)

All of the fields in the IPC segment are optional, except those listed in Table 4.4-16.

Table 4.4-16: IHE Profile –IPC Segment

SEQ	LEN	DT	OPT	TBL#	ITEM#	ELEMENT NAME
1	80	EI	R		00237	Accession Identifier
2	22	EI	R		00216	Requested Procedure ID
3	70	EI	R		00217	Study Instance UID
4	22	EI	R		00238	Scheduled Procedure Step ID
5	16	CE	R+		00239	Modality
6	250	CE	R2		00246	Protocol Code

Adapted from the HL7 Standard, version 2.5.1

2535

The Department System Scheduler uses the OMI message in a context different from the context of the ORM message sent between the Order Placer and Order Filler. As provided by the HL7 Standard, each OMI message shall convey information about Requested Procedure(s) pertaining to one order.

2540 The value of the IPC-1 field shall be identical in all IPC segments. See the HL7 Standard for further explanation of the use of the IPC segment within the OMI message.

4.4.4.2 Expected Actions

4.4.4.2.1 Use Cases

The intent of this section is to illustrate through use cases how key information is used in a Procedure Scheduled transaction.

2545 See RAD TF-1: 3.3 (Typical Process Flow) for illustrations of the following discussions:

- RAD TF-1: 3.3.2.1: In the case where the patient demographics are updated or patients are merged prior to placer order creation, this transaction occurs normally using the updated patient and visit information.
- 2550 • RAD TF-1: 3.3.2.2: In the case where the patient demographics are updated or patients are merged after a procedure has been scheduled, only a Patient Update transaction is required, and this transaction is not used.
- RAD TF-1: 3.3.3: In the case where an order is cancelled at the Order Placer or Order Filler and a new order is generated, the previously scheduled order transaction sent to the Image Manager or Report Manager shall be cancelled (Section 4.13) and a new Procedure Scheduled transaction shall be initiated for the “new” order.

2555

See RAD TF-1: 4.3 (Unidentified Patient Image Acquisition) for illustrations of the following discussions:

- 2560 • Case 1: In the case where a Temporary Patient Name and ID are assigned by an ADT system and an order is placed at the Order Placer, a Procedure Update transaction is not necessary (only a Patient Update transaction is necessary).
- Case 2: In the case where a Temporary Patient Name and ID are assigned by an ADT system but the order is placed at the Department System Scheduler, a Procedure Update transaction is not necessary (only a Patient Update transaction is necessary).

2565 In both cases 1 and 2, the DICOM attribute information mapping given in the Procedure Scheduled Transaction remains the same. That is, the Study Instance UID, Requested Procedure ID, Accession Number, etc., are supplied by the Department System Scheduler, are used by the modality and Image Manager or Report Manager, and are not changed.

- 2570 • Case 3: In this case a Temporary Patient Name and ID are assigned by an ADT system, no order is placed prior to image acquisition, but rather an order is placed after the exam is completed, the Study Instance UID is generated by the acquisition modality, and a Modality Performed Procedure Step is sent to the Image Manager, Report Manager and Department System Scheduler (containing the modality generated Study Instance UID). As always, the Study Instance UID contained within an object set remains the “master” key.

2575 At this point, a Procedure Scheduled transaction (Control Code = NW) must be sent to the Image Manager and Report Manager using the Study Instance UID contained in the MPPS message from the acquisition device. In this case, the information given in Table 4.4-17 must be altered by the Image Manager, Report Manager using the information received in the Procedure Update transaction by changing the DICOM objects.

2580 **Table 4.4-17: Data Mapping from ORM by Image Manager and Report Manager after Procedure Scheduled**

Attributes Overwritten in DICOM Instances Based on Procedure Scheduled information
Placer Order Number + Issuer
Filler Order Number + Issuer
Accession Number
Requested Procedure ID

Note: In case 3, the reconciliation of Scheduled Procedure Steps which are identified by the Department System Scheduler and contained in the Procedure Scheduled message with the Performed Procedure Steps that are actually contained in the DICOM objects (MPPS object) may not be consistent and do not need to be coerced. At this point, the number and identification of the Scheduled Procedure Steps is irrelevant because the procedure has already been performed.

2585 If a race condition should occur such that the Department System Scheduler has just created a Procedure Scheduled Transaction (and generated a Study Instance UID) and the Modality has generated DICOM objects (and generated a different Study Instance UID) it is the responsibility of the Department System Scheduler to reconcile these transactions by canceling the order (and Study Instance UID) that it generated internally and create a new Procedure Scheduled transaction using the Study Instance UID generated by the modality and provided in the Modality Performed Procedure Step transaction. In cases where this is a multi-modality study with multiple Study Instance UIDs, multiple Procedure Scheduled transactions must be generated by the Department System Scheduler. The studies may still be reported as one Requested Procedure (see Sections 4.24-6.27).

2590

2595

In case 3, a Patient Update Transaction(s) must still be sent to the Image Manager and Report Manager to update the patient demographic, visit information, and ID.

2600

2605

- Case 4: In the case where the Departmental System Scheduler assigns a Department Temporary Patient Name and ID and the procedure is scheduled, a Procedure Scheduled transaction is necessary and adequately provides the Study Instance UID and other information given in Table 4.4-17. Subsequently, a Patient Update transaction(s) is necessary.
- Case 5: In the case where no Temporary Patient Name nor ID are assigned by an ADT system, no order is placed in advance, but rather the patient is registered at the Department System Scheduler and the order is placed after the exam is complete a Procedure Scheduled transaction (Control Code = NW) must be sent to the Image Manager and the Report Manager. Similar to case 3, the Study Instance UID obtained in the Modality Performed Procedure Step message shall be used as the key by both the Department System Scheduler the Image Manager and the Report Manager. The Image

2610 Manager and the Report Manager must alter the information given in Table 4.4-11 using the information received in the Procedure Scheduled transaction.

In Case 5, a Patient Update Transaction(s) must still be sent to the Image Manager and Report Manager to update the patient demographic, visit information and ID.

2615 **4.5 Query Modality Worklist [RAD-5]**

This section corresponds to Transaction RAD-5 of the IHE Technical Framework. Transaction RAD-5 is used by the Department System Scheduler/Order Filler and worklist clients such as Acquisition Modalities and Importers.

4.5.1 Scope

2620 This transaction takes place under two circumstances. The first is for the scheduling of an acquisition, the second is for the scheduling of an importation of existing Evidence Objects or Hardcopy. This transaction takes place at the Acquisition Modality at the point of scan/acquisition by a technologist. When a patient arrives for the scheduled procedure, the technologist performing the procedure must examine key information elements as they relate to
2625 the procedure, the correctness of the procedure that has been ordered, and comments that may have been entered by the referring physician and/or radiologist, among others. The technologist at the Acquisition Modality uses the DICOM Modality Worklist to query the Department System Scheduler/Order Filler for Scheduled Procedure Steps. The list is downloaded to the Acquisition Modality and the technologist verifies the information on the Acquisition Modality console. In
2630 the Modality Images Stored transaction this information will be included in the header of the generated images (See Section 4.8 and Appendix A).

An importation may occur with existing DICOM Objects or the creation of DICOM Objects as part of the importation (e.g., the digitization of films into DICOM Objects). The actual scheduling of the importation may vary. For example, the importation may be scheduled as part
2635 of an externally referred acquisition, or upon the receipt of a physical PDI media containing patient images required for an upcoming consultation. The User at the Importer uses the DICOM Modality Worklist to query the Department System Scheduler/Order Filler for Scheduled Procedure Steps. The User must be able to verify that Evidence Objects or the Hardcopy data to be imported as DICOM Composite Objects are for the correct Patient and Scheduled Procedure
2640 Step. In the Imported Objects Stored transaction this information will be included in the header of the imported Evidence Documents (See RAD TF-3: 4.61. and Appendix A.5).

4.5.2 Use Case Roles

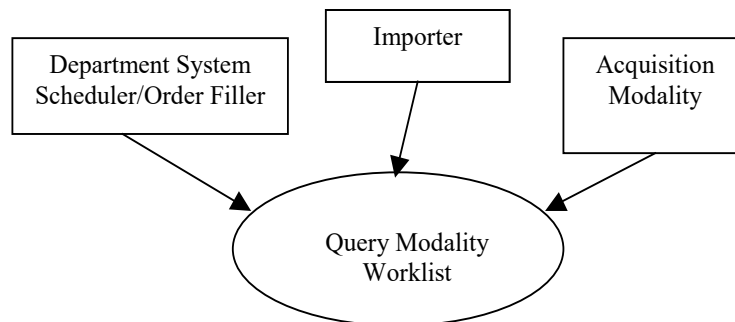

2645 **Actor:** Acquisition Modality

Role: Responsible for requesting and receiving data from the Department System Scheduler/Order Filler.

Actor: Importer

2650 **Role:** Responsible for requesting and receiving data from the Department System Scheduler/Order Filler.

Actor: Department System Scheduler/Order Filler

Role: Responsible for accepting requests for MWL from an acquisition modality, performing the query, and sending the response back.

4.5.3 Referenced Standards

2655 DICOM PS 3.4: Modality Worklist SOP Class

4.5.4 Interaction Diagram

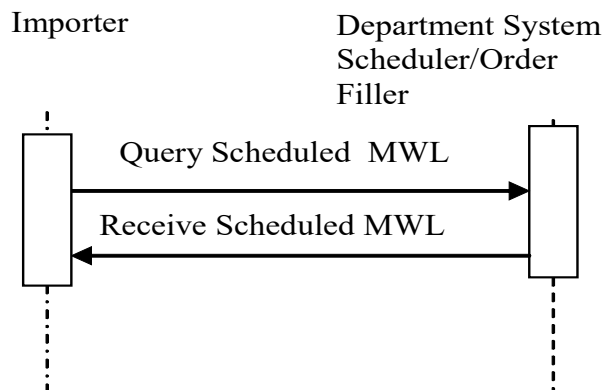
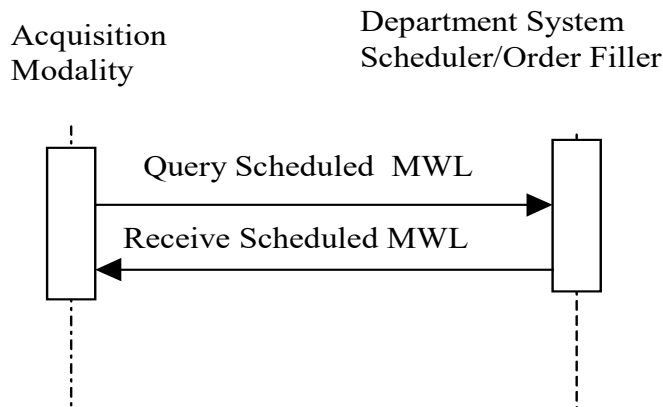

2660 4.5.4.1 Query Scheduled MWL Message

This is the worklist query message sent to the Department System Scheduler/Order Filler.

4.5.4.1.1 Trigger Events

The patient arrives at the Acquisition Modality for a procedure (scan/acquisition).

2665 The trigger event for an importation is a User that wants to perform a scheduled importation. The actual trigger for scheduling the importation is site specific, but may be triggered by such events as:

- Arrival of films as a result of a request for a scheduled consult.
- Patient with a scheduled procedure brings prior Evidence Objects on a PDI Media.
- Other communications not specified further by the IHE Radiology Technical Framework which result in the scheduling of an import.

2670

4.5.4.1.2 Message Semantics

The Acquisition Modality or Importer uses the C-FIND Request of the DICOM Modality Worklist SOP Class to query for the worklist from the DSS/Order Filler. The Acquisition Modality or Importer performs the SCU role, and the DSS/Order Filler the SCP role.

2675 Acquisition Modalities and Importers shall support individually each one of the required query keys listed in Table 4.5-3 - Matching and Return Keys For Modality Worklist. For Importers, Patient Based Query shall be supported. For Acquisition Modalities, at least one of the following two combinations of keys shall be supported by the Acquisition Modality:

2680 **1. The Patient Based Query:** Query for a worklist specific for a particular patient. The SCU shall support all (15) combinations of the matching key attributes listed in Table 4.5-1 by including 1 or more keys.

Table 4.5-1: MWL Keys for Query by Patient

Matching Key Attributes	Tag
Patient's Name	(0010,0010)
Patient ID	(0010,0020)
Accession Number	(0008,0050)
Requested Procedure ID	(0040,1001)

2685 **2. The Broad Query:** Query for a broad worklist. The SCU shall support all (7) combinations of the matching key attributes listed in Table 4.5-2 by including 1 or more keys.

Table 4.5-2: MWL Keys for Broad Worklist Queries

Matching Key Attributes	Tag
Scheduled Procedure Step Start Date	(0040,0002)
Modality	(0008,0060)
Scheduled Station AE-Title	(0040,0001)

4.5.4.1.2.1 Examples for the Use of Matching Key Attributes

- Using the Scheduled Procedure Step Start Date: query for all the procedures in my department that are scheduled for the start date specified.
- 2690 • Using the Modality key: query for all the procedures that are scheduled on this type of modality (e.g., all CT exams).
- Using AE Title key: query for all the procedures that are scheduled on the modality with the specified AE Title.
- 2695 • Using the Scheduled Procedure Step Start Date and Modality keys: query for all the CT procedures that are scheduled for today.
- Using the Patient Name, Patient Birth Date and Patient Sex query for all the procedures that are scheduled for a patient.
- Using the Patient Name and AE Title query for all procedures to be imported for a Patient.
- 2700 Note: DICOM defines that dates and times are matched by their meaning, not as literal strings. If an application is concerned about how a single value matching of dates and times is performed by another application, it may consider using range matching instead (e.g., "<today>-<today>"), which is always performed by meaning.
- Note: Applications are recommended to append a wildcard "*", if one was not previously entered by the user, at the end of each component of the structured Patient Name.

2705 4.5.4.1.2.2 Matching Keys and Return Keys

The Modality is required to query for specific attributes (return keys) that will be inserted into the image objects. The requirements for the attributes in the stored images are defined in Section 4.8 and Appendix A. There are additional attributes that may be queried for use on the Acquisition Modality (e.g., displayed for the user) but might not be inserted into the composite image object.

2710

Table 4.5-3 summarizes the matching key requirements and lists the optional and required attributes that may be requested by the SCU and shall be returned by the SCP in order to make these available to the user at the Acquisition Modality. Requirements indicated with R+ or R+* highlight the requirements added by the IHE Technical Framework. See Section 2.2 for more information. All display requirements are an addition to the DICOM Standard requirements for the Modality Worklist SOP Class.

2715

The Importer is required to query for specified attributes (return keys) that will be used to modify the imported objects. The attribute modification requirements are defined in RAD TF-3: 4.61.4.1.2.1 and Appendix A.5.

2720

Table 4.5-3: Return and Matching Keys For Modality Worklist

Attribute Name	Tag	Query Keys Matching		Query Keys Return	
		SCU	SCP	SCU	SCP
Scheduled Procedure Step					
Scheduled Procedure Step Sequence	(0040,0100)			[IHE-1]	[IHE-2]
>Scheduled Station AE Title	(0040,0001)	R+	R	R+*	R
>Scheduled Procedure Step Start Date	(0040,0002)	R+	R	R+	R
>Scheduled Procedure Step Start Time	(0040,0003)	O	R	R+	R
> Scheduled Procedure Step Location	(0040,0011)	O	O	O	O
>Modality	(0008,0060)	R+	R	R+	R
>Scheduled Performing Physician's Name	(0040,0006)	O	R	O	R
>Scheduled Procedure Step ID	(0040,0009)	O	O	R+*	R
>Scheduled Protocol Code Sequence	(0040,0008)				
>>Code Value	(0008,0100)	O	O	R+*	R
>>Coding Scheme Version	(0008,0103)	O	O	O	O
>>Coding Scheme Designator	(0008,0102)	O	O	R+*	R
>>Code Meaning	(0008,0104)	O	O	R+	R+
>Scheduled Procedure Step Description	(0040,0007)	O	O	R+	R
Requested Procedure					
Requested Procedure Comments	(0040,1400)	O	O	O	O
Requested Procedure Description	(0032,1060)	O	O	R+	R
Requested Procedure Code Sequence	(0032,1064)				
>Code Value	(0008,0100)	O	O	R+*	R
>Coding Scheme Version	(0008,0103)	O	O	O	O
>Coding Scheme Designator	(0008,0102)	O	O	R+*	R
>Code Meaning	(0008,0104)	O	O	R+	R+
Requested Procedure ID	(0040,1001)	R+ (Note 1)	R+ (Note 1)	R+	R
Names of Intended recipients of results	(0040,1010)	O	O	O	O
Study Instance UID	(0020,000D)	O	O	R+*	R
Referenced Study Sequence	(0008,1110)				
>Referenced SOP Class UID	(0008,1150)	O	O	R+*	R
>Referenced SOP Instance UID	(0008,1155)	O	O	R+*	R
Imaging Service Request					

Attribute Name	Tag	Query Keys Matching		Query Keys Return	
		SCU	SCP	SCU	SCP
Imaging Service Request Comments	(0040,2400)	O	O	O	O
Accession Number	(0008,0050)	R+ (Note 1)	R+ (Note 1)	R+	R+ [IHE-3]
Requesting Physician	(0032,1032)	O	O	O	R
Requesting Service	(0032,1033)	O	O	O	O
Referring Physician's Name	(0008,0090)	O	O	R+	R
Visit Identification					
Admission ID	(0038,00100)	O	O	O	R
Visit Status					
Current Patient Location	(0038,0300)	O	O	O	R
Visit Relationship					
Referenced Patient Sequence	(0008,1120)				
>Referenced SOP Class UID	(0008,1150)	O	O	O	R
>Referenced SOP Instance UID	(0008,1155)	O	O	O	R
Patient Identification					
Patient's Name	(0010,0010)	R+	R	R+	R
Patient ID	(0010,0020)	R+	R	R+	R
Other Patient ID's	(0010,1000)	O	O	O	O
Patient Demographic					
Patients Birth Date	(0010,0030)	O	O	R+	R
Patient's Sex	(0010,0040)	O	O	R+	R
Confidentiality constraint on patient data	(0040,3001)	O	O	O	R
Ethnic Group	(0010,2160)	O	O	O	O
Patient Comment	(0010,4000)	O	O	O	O
Patient Medical					
Patient State	(0038,0500)	O	O	O	R
Pregnancy Status	(0010,21C0)	O	O	O	R
Medical Alerts	(0010,2000)	O	O	O	R
Additional Patient History	(0010,21B0)	O	O	O	O
Contrast Allergies	(0010,2110)	O	O	O	R
Patient Weight	(0010,1030)	O	O	O	R
Special Needs	(0038,0050)	O	O	O	R

Note 1: The matching performed by the SCP for the Requested Procedure ID and Accession Number attributes shall be single value (SV) matching.

2725 (IHE-1): SCU implementations may choose to obtain the values contained in attributes that are part of the Scheduled Procedure Step sequence in either one of three ways. The first one is to request a universal match on the sequence attribute (zero length attribute). The second one is a

2730 universal sequence match (zero length item) for all attributes of the Scheduled Procedure Step sequence. The third one is to request a universal attribute match for selected attributes contained in the Scheduled Procedure Step sequence.

2735 (IHE-2): SCP implementations shall support, per the DICOM Standard, three ways to let the Query SCU obtain the values contained in attributes that are part of the Scheduled Procedure Step sequence. The first one is to support a universal match on the sequence attribute (zero length attribute), and all managed attributes will be returned. The second one is to support a universal sequence match (zero length item) for all attributes of the Scheduled Procedure Step sequence, and all managed attributes will be returned. The third one is to support a universal attribute match for selected attributes contained in the Scheduled Procedure Step sequence, and the managed attributes that were selected will be returned.

2740 (IHE-3): A value (Non empty field) shall be returned in the Accession Number attribute if the field was requested by the MWL SCU.

4.5.4.1.3 Expected Actions

The Departmental System Schedule/Order Filler performs the query and sends the DICOM Modality Worklist to the Acquisition Modality or Importer.

2745 The Importer shall make available to the Operator the information in the Scheduled Procedure Step Description (see Table 4.5-3). This information may include:

- A description of specific Evidence Objects to import (e.g., only a particular study, series or image should be imported).

4.5.4.2 Receive Scheduled MWL Message

2750 This is the message that the Department System Scheduler sends to the modality as a reply containing DICOM Modality Worklist information.

4.5.4.2.1 Trigger Events

The Departmental System Scheduler/Order Filler had received a query for a MWL.

4.5.4.2.2 Message Semantics

2755 C-FIND Response from the DICOM Modality Worklist SOP Class will be used for this message. Some of the attributes queried through the MWL SOP class originate with the Order Placer and ADT, while other attributes are managed internally by the Department System Scheduler/Order Filler.

2760 The DSS/Order Filler will determine the Requested Procedures needed to fulfill the Order, and decompose the Requested Procedures into one or more Scheduled Procedure Steps, assigning proper Scheduled Protocol Codes. The DSS/Order Filler shall support the definition of multiple Protocol Codes in a Scheduled Protocol Code Sequence contained in the Scheduled Procedure Steps for any Requested Procedure. Coded Values shall be used to specify exactly what actions

are to be performed at the Acquisition Modality - the DSS/OF shall be configurable to provide such codes.

2765 In addition to these Coded Values further instructions for the technologist may be specified. It is recommended to use the Scheduled Procedure Step Description and the Requested Procedure Description attributes for these additional specific instructions (free text).

2770 The organization operating the DSS/OF and the Modalities is responsible for synchronizing Procedure and Protocol Codes between all the systems that use such codes. IHE does not yet define a common mechanism for code synchronization or access.

Appendix B defines the origin and mappings of the attributes returned in a MWL query.

2775 The details of the C-FIND Response from the DICOM MWL SOP Class are depicted in Table 4.5-3 and appendix A. At the time images are being created/generated, these attributes will be stored into the DICOM image instance headers. The Acquisition Modality or Importer may need additional information; however this is beyond the scope of this document. Refer to RAD TF-1: Appendix A for a discussion of Accession Number and Procedure ID.

2780 An Order may be cancelled after the corresponding Requested Procedure(s) and Scheduled Procedure Steps have been scheduled, and possibly even after a Performed Procedure Step has been started. In this case the Department System Scheduler/Order Filler shall remove the Scheduled Procedure Steps of the Order from its worklist, and the absence of these Scheduled Procedure Steps in the next C-FIND response to the Acquisition Modality or Importer will indicate that the procedure has been cancelled. In this way the technologist recognizes that the previously scheduled steps no longer need to be performed.

2785 It is the responsibility of the Department System Scheduler/Order Filler to ensure that the patient and procedure information is current in the Modality Worklist response. The Department System Scheduler/Order Filler receives patient and procedure updates through transactions RAD-2, RAD-3 and RAD-12.

4.5.4.2.2.1 Scheduled Protocol Sequence for Import

2790 The Department System Scheduler/Order Filler has the ability to provide instructions to the Importer on what should be done with the imported Evidence Objects after they are imported through the use of the Scheduled Protocol Sequence (0040,0008). Zero or more items may be present. Table 4.5-4 provides a list of the valid codes that may be used.

If present the codes are intended to be made available for copying into the Performed Protocol Sequence (0040,0260) in order to convey the subsequent use of the instances.

2795

Table 4.5-4: Import Instruction Codes

Coding Scheme Designator (0008,0102)	Code Value (0008,0100)	Code Meaning (0008,0104)
IHERADTF	IRWF001	Import
IHERADTF	IRWF002	To be interpreted

Coding Scheme Designator (0008,0102)	Code Value (0008,0100)	Code Meaning (0008,0104)
IHERADTF	IRWF003	To be archived
IHERADTF	IRWF004	To be over read
IHERADTF	IRWF005	To be post-processed
IHERADTF	IRWF006	To be printed
IHERADTF	IRWF007	To be provided as a prior
IHERADTF	IRWF008	Destroy original media
IHERADTF	IRWF009	Return original media to patient
IHERADTF	IRWF010	Return original media to sender
IHERADTF	IRWF011	Archive original media

4.5.4.2.3 Expected Actions

The technologist checks for the existence of the Scheduled Procedure Steps, validates the displayed patient and procedure information, and checks the given instructions.

2800 When an Acquisition Modality supports the ASSISTED ACQUISITION PROTOCOL SETTING Option, it shall provide the means to use the protocol codes specified in the Scheduled Procedure Steps selected from the Modality Worklist (See Section 4.6.4.1.2.4.2 Assisted Acquisition Protocols Setting Option).

2805 For imports, the User checks for the existence of the Scheduled Procedure Steps, validates the selected Patient Demographics with the Patient demographics of the existing Evidence Objects or the hardcopy, and checks for special instructions given in the Scheduled Procedure Step Description on what Evidence Objects are to be imported (e.g., how many PDI Media or films are associated with the Scheduled Procedure Step). In addition, the Importer shall provide the means to use the protocol codes specified in the Scheduled Procedure Step selected from the Modality Worklist (See RAD TF-3: 4.59.4.1.2.3.3 Import Instruction Codes).

2810

4.6 Modality Procedure Step In Progress [RAD-6]

2815 This section corresponds to Transaction RAD-6 of the IHE Technical Framework. Transaction RAD-6 is used by the Department System Scheduler/Order Filler, Image Manager, Performed Procedure Step Manager, Report Manager and Acquisition Modality Actors.

4.6.1 Scope

2820 This transaction includes a message from the Acquisition Modality to the Performed Procedure Step Manager, which in turn issues the message to the Department System Scheduler/Order Filler, the Image Manager and the Report Manager that the Performed Procedure Step is in progress. This may be an unscheduled procedure step. The receiving Performed Procedure Step Manager is grouped with the Image Manager or the Department System Scheduler/Order Filler, and shall support forwarding messages to two other destinations besides the actor it is grouped with. It shall start issuing messages to the configured destinations immediately after it accepts the corresponding messages from the Acquisition Modality.

2825 To allow for proper integration, the following considerations must be taken into account:

- 2830 • The Performed Procedure Step Manager must maintain proper PPS objects and then store them until corresponding N-CREATE and N-SET messages are transmitted to the actor it is grouped with, and the two other Actors. If transmission to a destination fails, the Performed Procedure Step Manager shall try to repeat transmission periodically until it succeeds. The Performed Procedure Step Manager must not use failure of one or more of these transmissions as a reason for rejecting the initial transmission from the Acquisition Modality;
- 2835 • Because both the Image Manager and the Department System Scheduler/Order Filler incorporate the Performed Procedure Step Manager function, an infinite redistribution of PPS messages is possible. The Image Manager and the Department System Scheduler/Order Filler systems that provide the Performed Procedure Step Manager function shall be configurable to disable this function;
- 2840 • Transfer of the information to the system that the receiving Performed Procedure Step Manager is integrated with is outside the scope of the IHE Radiology Technical Framework (i.e., internal to an implementation).

4.6.2 Use Case Roles

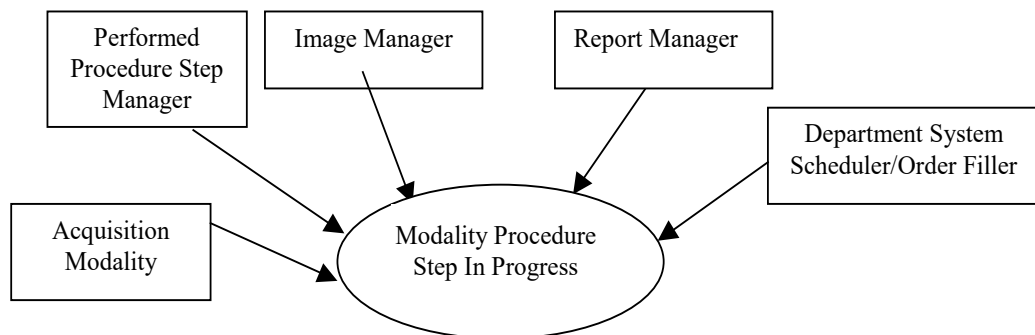

Actor: Department System Scheduler/Order Filler

Role: Receives the PPS information forwarded by the PPS Manager

2845 **Actor:** Image Manager

Role: Receives the PPS information forwarded by the PPS Manager

Actor: Report Manager

Role: Receives the PPS information forwarded by the PPS Manager

Actor: Acquisition Modality

2850 **Role:** Informs the Performed Procedure Step Manager that a particular Performed Procedure Step has started

Actor: Performed Procedure Step Manager

2855 **Role:** Accepts Performed Procedure Step information from an Acquisition Modality and transmits it to the Department System Scheduler/Order Filler, Image Manager and Report Manager

4.6.3 Referenced Standards

DICOM PS 3.4: Modality Performed Procedure Step SOP Class.

4.6.4 Interaction Diagram

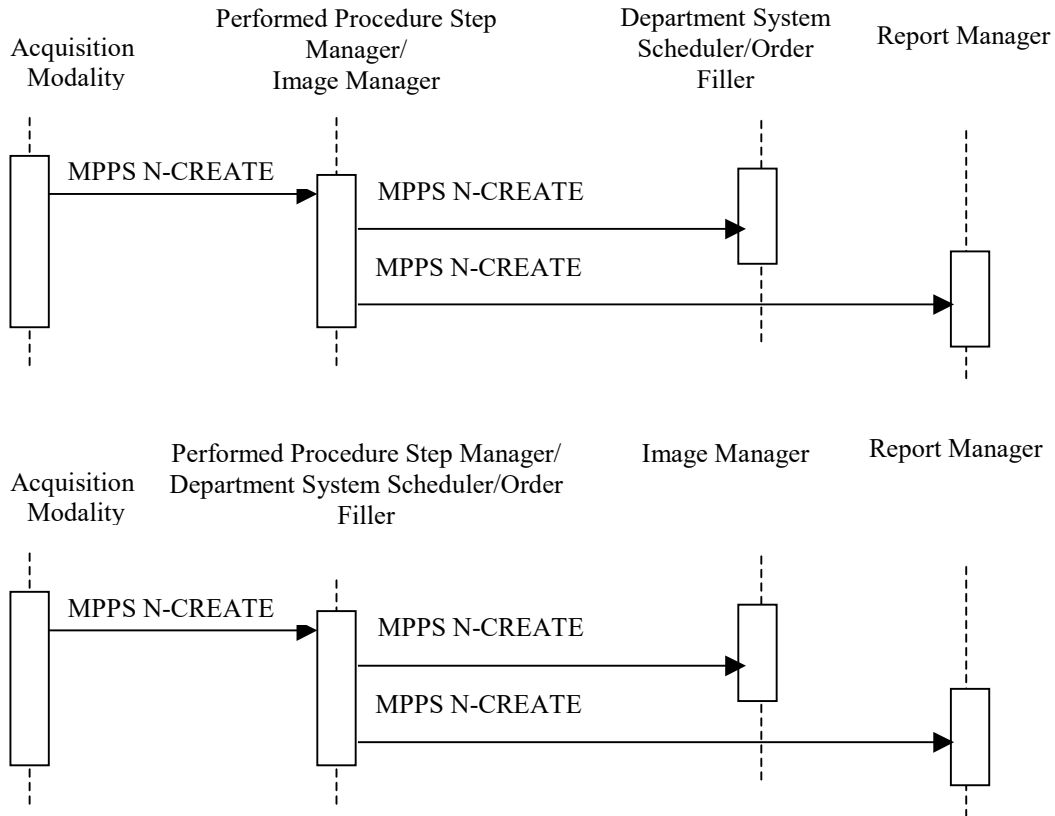

2860

4.6.4.1 Procedure Step In Progress Message

4.6.4.1.1 Trigger Event

Technologist begins procedure step from the Acquisition Modality console.

4.6.4.1.2 Message Semantics

2865 The Acquisition Modality uses the Modality Performed Procedure Step SOP Class (N-CREATE Service) to inform the Performed Procedure Step Manager that a specific Procedure Step has been started and is in progress. In turn, the Performed Procedure Step Manager uses the N-CREATE service to forward the information to the Department System Scheduler/Order Filler Image Manager and Report Manager. The SOP Instance UID value of the Performed Procedure Step shall be conveyed in the Affected SOP Instance UID (0000,1000) during this interchange (see also corresponding notes in Appendix A.1). The following aspects shall be taken into account during implementation of this step:

2870

4.6.4.1.2.1 Patient/Procedure/Scheduled Procedure Step Information

2875 The Acquisition Modality shall ensure that the Patient/Procedure/Scheduled Procedure Step information it has is valid and current.

4.6.4.1.2.2 Required Attributes

2880 Appendix A lists a number of attributes that have to be properly handled by the Acquisition Modality to ensure consistency between the Performed Procedure Step object attributes, Scheduled Step information in the Modality Worklist, and the information included in the generated SOP instances.

4.6.4.1.2.3 Relationship between Scheduled and Performed Procedure Steps

The relationship between Scheduled and Performed Procedure Step information is shown in the following 6 cases. Refer to Appendix A for details of forming attributes (Study Instance UID, Procedure ID, Accession Number, etc.) in each of these cases.

2885 **4.6.4.1.2.3.1 Simple Case**

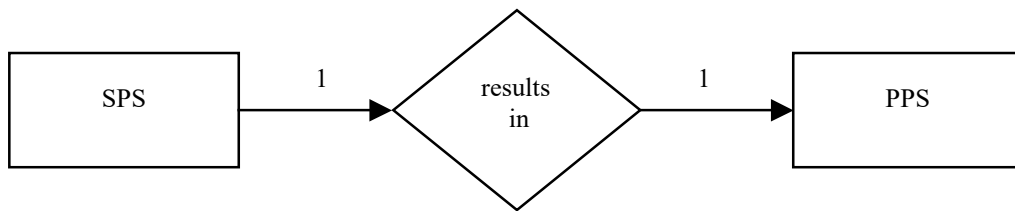

This case indicates a 1-to-1 relationship between SPS and PPS. Information about the Scheduled Procedure Step and Requested Procedure shall be copied from the Scheduled Procedure Step object to the Performed Procedure Step Relationship Module (see Appendix A).

2890 Examples: A Procedure Step was performed exactly as scheduled. It could also be that a Procedure Step was not exactly performed as scheduled, but without being rescheduled, e.g., due to a patient’s allergic reaction to contrast media.

4.6.4.1.2.3.2 Unscheduled Case

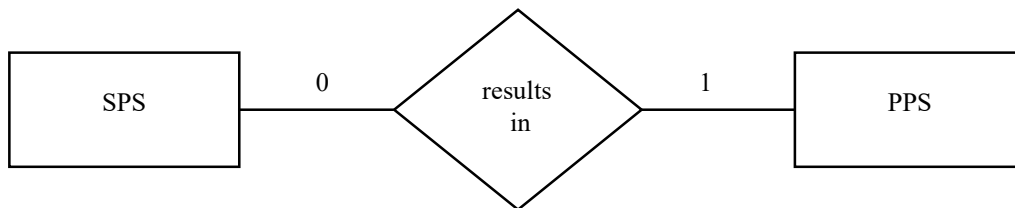

2895 This case indicates a 0-to-1 relationship between SPS and PPS. Information about the Scheduled Procedure Step and, possibly, Requested Procedure is not available to the Acquisition Modality due to different reasons (emergency procedure, Modality Worklist SCP not available, etc.).

The Patient ID entered on the Acquisition Modality by the technologist shall be the one created by the Assigning (Issuer) Authority (refer to Appendix D).

2900 **4.6.4.1.2.3.3 Append Case**

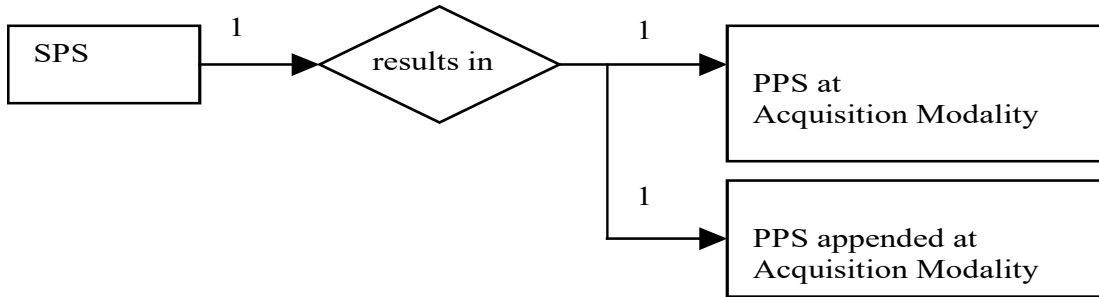

Append to a Normal Case

This is a case of 1-to-N relationship between SPS and PPS where first the PPS is generated in response to an SPS, as in the simple case. Other Performed Procedure Steps that have not been scheduled by additional SPSs are added sequentially at a later time, for instance

2905

- due to unacceptable quality of certain images (“redo” certain images)
- because head MR images from a patient with severe headache that were just acquired are inconclusive, so that additional neck MR images are performed immediately (“add” certain images)

2910

Note that the scheduling of the additional procedure would have resulted in two simple cases.

All Performed Procedure Steps shall refer back to the same Requested Procedure and to the original SPS. All Requested Procedure and Scheduled Procedure Step attributes shall be copied from the Scheduled Procedure Step Object to the Performed Procedure Step Relationship Module and the image Request Attribute Sequence (see Appendix A).

2915

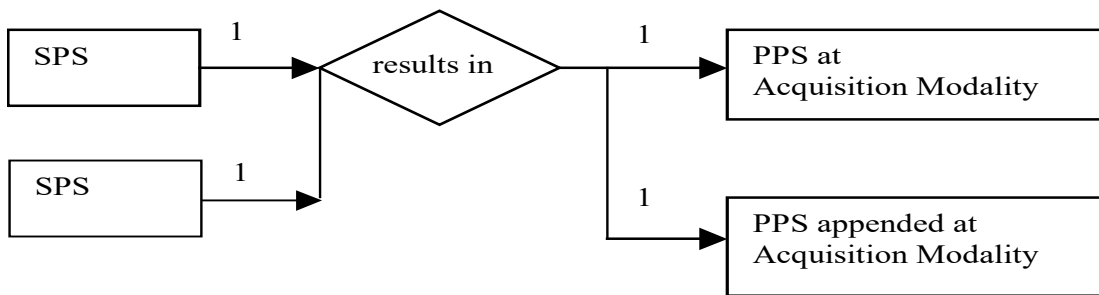

Append to a Group Case

2920 When the first PPS generated at the Acquisition Modality results from a Group Case (See
 Section 4.6.4.1.2.3.4 or 4.6.4.1.2.3.6), the Performed Procedure Step appended by the
 Acquisition Modality may refer back to any one or all of the original SPSs and related Requested
 Procedure(s), using information from the Request Attribute Sequence in the original images. The
 corresponding attributes shall be copied to the Performed Procedure Step Relationship Module
 and the image Request Attribute Sequence (see Appendix A).

2925 Note: For example, following a PPS performed on an MR Modality in response to the grouping of a "neck" SPS and a
 "head" SPS, a 3D analysis on the MR head images is performed on the modality. This modality application may
 choose to link the appended PPS associated with the 3D secondary captures images resulting from the 3D analysis
 with both the head and the neck SPS.

4.6.4.1.2.3.4 Group Case

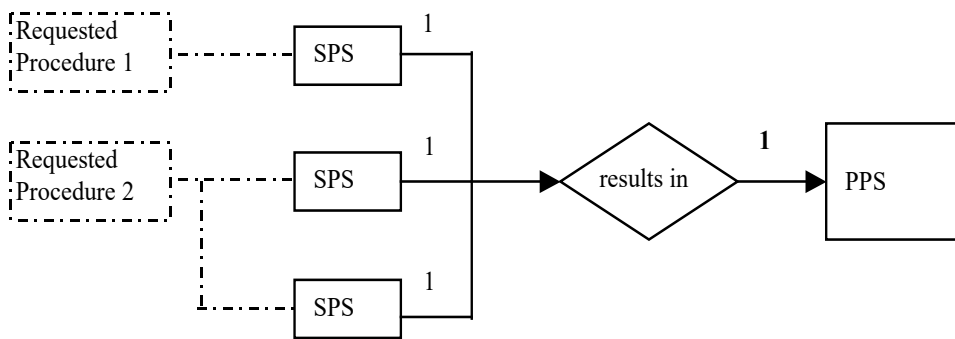

2930 This case indicates an N-to-1 relationship between SPS and PPS. The following sub-cases shall
 be supported and fulfilled by a single Performed Procedure Step:

- a. Grouped SPSs belonging to a single Requested procedure
- b. Grouped SPSs belonging to multiple Requested Procedures
- c. A combination of Grouped SPSs belonging to multiple Requested procedures and
 2935 Grouped SPSs belonging to a single Requested Procedure.

If all grouped SPSs belong to the same Requested Procedure, then the Study Instance UID and
 Accession Number from the MWL shall be copied to the corresponding attributes of the grouped
 images and in the grouped PPS.

2940 If the grouped SPSs belong to different Requested Procedures sharing the same Accession
 Number (i.e., same Order), the Modality shall generate a new Study Instance UID and the
 Accession Number from the MWL shall be copied to the corresponding attributes of the grouped
 images and the grouped PPS (see Appendix A.1-4 for mapping details). If the grouped SPSs
 belong to different Requested Procedures with different Accession Numbers (i.e., different
 Orders), the Modality shall generate a new Study Instance UID, leave the Accession Number
 2945 empty in grouped Images and copy the Accession Number from the MWL to the corresponding
 attributes in grouped PPS (see Appendix A.1-4 for mapping details).

All Requested Procedure and Scheduled Procedure Step attributes shall be copied from the
 multiple Scheduled Procedure Step Objects (and associated Requested Procedures) to the
 Performed Procedure Step Relationship Module in the single Performed Procedure Step and to

2950 the Request Attribute Sequence in Images (See Appendix A for proper mappings to MPPS and Images).

Support for the group case by the Acquisition Modality is required in the Presentation of Grouped Procedures Integration Profile. In the Scheduled Workflow and Charge Posting Integration Profiles, a Modality may claim the support of the MODALITY GROUP CASE Option. When supported this option implies that sub-cases a), b), and c) above shall be supported.

2955

The DSS/Order Filler, Image Manager Report Manager and Performed Procedure Step Manager are always required to accept Performed Procedure Steps containing attributes from multiple Scheduled Procedure Steps and Requested Procedures in Integration Profiles where those actors accept Modality Performed Procedure Step Transactions.

2960

4.6.4.1.2.3.5 Abandoned Case

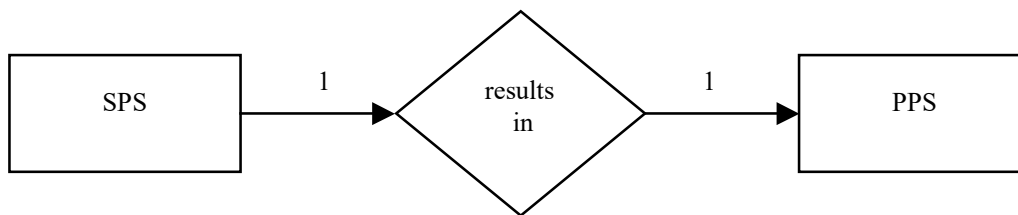

This case indicates a 1-to-1 relationship between SPS and PPS, even though the PPS may or may not create images. A procedure step may have to be abandoned for clinical reasons before it is complete. If SOP instances are sent by the Acquisition Modality to the Image Archive, then they shall be identified in the PPS N-SET. This is a means to explicitly communicate this information to the Image Manager or Department System Scheduler/Order Filler. In addition, one may choose to use this abandoned case to remove Scheduled Procedure Steps from the worklist, by starting the corresponding Performed Procedure Step and immediately discontinuing it using the N-SET service with the status value DISCONTINUED. All Requested Procedure and Scheduled Procedure Step attributes shall be copied from the Scheduled Procedure Step Object to the Performed Procedure Step Relationship Module (see Appendix A).

2965

2970

4.6.4.1.2.3.6 Group Case with Presentation of Grouped Procedures

This case applies only in the context of the Presentation of Grouped Procedures Integration Profile. It applies to the subcases b) and c) of the Group Case (Section 4.6.4.1.2.3.4) and to the Append Case (Section 4.6.4.1.2.3.3) along with the rules specified in this section. Refer to RAD TF-1:6 for the use cases associated with the Presentation of Grouped Procedures. Presentation of Grouped Procedures in the a) subcase is equivalent to the use of the CPI Integration Profile. It is therefore out of scope for this section.

2975

2980

First, this case indicates an N-to-1 relationship between SPS and a first PPS. SPSs belong to two or more different Requested Procedures, and are fulfilled by a single Performed Procedure Step. This Performed Procedure Step is related to the images (and possibly presentation states, key

2985 image notes, etc.) acquired in a single acquisition. All Requested Procedure and Scheduled
 Procedure Step attributes shall be copied from the multiple Scheduled Procedure Step Objects to
 the Performed Procedure Step Relationship Module in the single Performed Procedure Step (see
 Appendix A) and to the Request Attribute Sequence in Images (see Appendix A). This is a
 proper subset of the Group Case specified in Section 4.6.4.1.2.3.4.

2990 Second, this case indicates a 1-to-1 relationship between the SPSs of each Requested Procedure
 and an additional corresponding PPS. All SPSs belonging to the same Requested Procedure are
 fulfilled by a corresponding Performed Procedure Step. The Requested Procedure and Scheduled
 Procedure Step attributes shall only be copied from the related Scheduled Procedure Step
 Object(s) to the Performed Procedure Step Relationship Module in the Performed Procedure Step
 (see Appendix A) related to the specific Presentation State(s) intended to present the
 2995 corresponding subset of images for the Requested Procedure. This is a proper subset of the
 Append Case specified in Section 4.6.4.1.2.3.3, with the exception that the Study Instance UID
 used for the Presentation States shall be the same as the one created for the image set acquired as
 part of the first PPS (see Appendix A, Table A.1-4).

The Presentation of Grouped Procedure operates at the Requested Procedure level whereas
 grouping operates at the level of Scheduled Procedure Steps.

3000

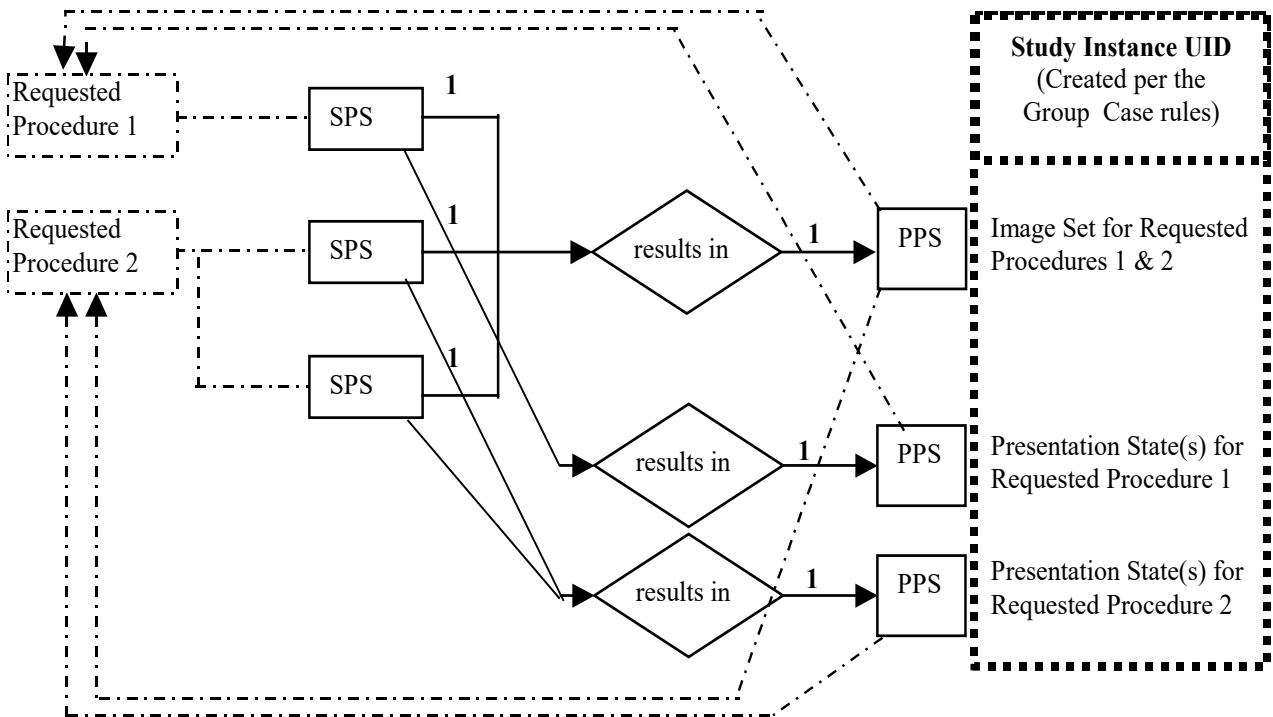

4.6.4.1.2.4 Protocol Handling

3005 The protocol (a specific combination of modality settings or a method) used in performing a procedure step shall be determined on the Acquisition Modality at this time. Two cases/options are defined: Manual Modality Setting and Assisted Modality Setting. The first case is the one that is currently most commonly used while the second case introduces new functionality and is optional for the IHE Technical Framework.

3010 The Acquisition Modality shall not change the Requested Procedure Code it obtains through the MWL. If the Requested Procedure Code is not correct or needs to be changed at the time the procedure is being performed, one of the following two methods shall be used:

- Department System Scheduler Method: The Procedure Information shall be corrected on the Department System Scheduler/Order Filler, and updated information shall be downloaded to the Acquisition Modality, OR
- 3015 • Acquisition Modality Method: The Acquisition Modality redefines Protocol Code(s) for the Procedure Steps it actually performs and sets the Procedure Code Sequence (0008,1032) to zero length.

The specification for which methods are required or optional is found in the Scheduled Workflow Integration Profile (RAD TF-1: 3.3.4).

3020 **4.6.4.1.2.4.1 Manual Modality Setting**

An operator selects and sets a protocol based on manual interpretation/evaluation of the Requested Procedure (RP) code and/or the Scheduled Procedure Step description and content of the Scheduled Protocol Code Sequence (SPCS). Note that the Scheduled Protocol Code Sequence, if present, may contain multiple items, however, they describe a single Protocol.

3025 Note: Scheduled Action Item Code Sequence has been redefined in 2001 by the DICOM standard as Scheduled Protocol Code Sequence.

This approach may also be used in cases when the protocol identifies more of a method used in performing the acquisition (such as in ultrasound), rather than a set of fixed modality settings (such as in CT/MR).

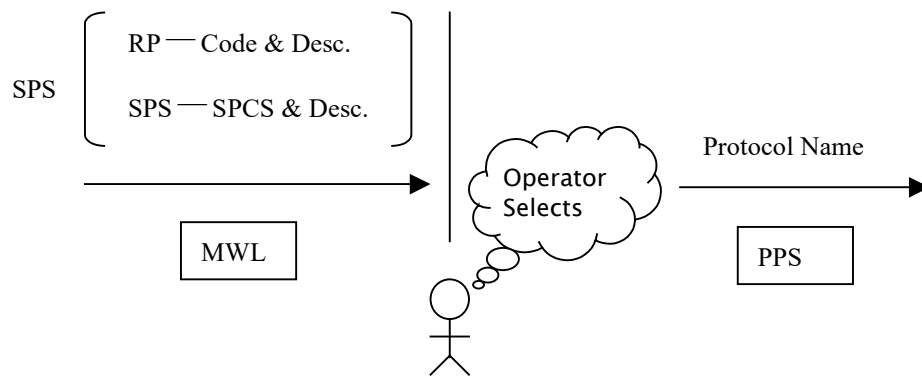

3030

In this Manual Modality Setting, the Scheduled Protocol Code Sequence is analyzed by the Operator. The Acquisition Modality is not required to provide a value for the Performed Protocol Code Sequence. (Only the Protocol Name is required to be sent).

4.6.4.1.2.4.2 Assisted Acquisition Protocol Setting Option

3035 When an Acquisition Modality supports the ASSISTED ACQUISITION PROTOCOL SETTING Option, it shall provide the means to use the protocol codes specified in the Scheduled Procedure Steps selected from the Modality Worklist.

3040 According to the DICOM standard (PS 3.3): "A Protocol is a specification of actions prescribed by a Procedure Plan to perform a specific Procedure Step. A Scheduled Procedure Step contains only one Protocol that may be conveyed with one or more Protocol Codes. So, each Scheduled Procedure Step is performed according to a single Protocol which may be identified by one or more Protocol Codes." This option refines the semantics of the interpretation of Protocol Codes specifically in the case where more than one Protocol Code is present.

A Scheduled Procedure Step may contain a single Protocol Code, for example:

- 3045
- A "Standard Chest X-ray" Protocol Code. This implies PA and Lateral views.
 - A "Screening Mammography" Protocol Code. This implies RMLO and LMLO, RCC and LCC views.

3050 A Scheduled Procedure Step may also contain multiple Protocol Codes in cases where more complex SPS requires several acquisition or image processing tasks be performed in a sequential manner, for example:

- An "MRI Acquisition" Protocol Code followed by an "MRA Acquisition" Protocol Code.
- A "CT Head without contrast" Protocol Code followed by a "CT with contrast" Protocol Code.
- 3055 • A "CT Lumbar Spine" Protocol Code followed by a "Reformation of the discs" Protocol Code.
- A "CT Thorax" protocol Code followed by a "Recon with lung kernel" Protocol Code.

3060 In this option, an Acquisition Modality shall process the protocol code sequence in each Scheduled Procedure Step (SPS) selected from the Modality Worklist and return the Performed Protocol Codes in the Performed Procedure Step (PPS). Modalities shall support one or more codes in the Scheduled Protocol Code (SPC) sequence.

- Department System Schedulers will (per DICOM) support the use of more than one Protocol Code in the Scheduled Protocol Code (SPC) Sequence. The institution may decide to configure its Department System Scheduler to schedule all Scheduled Procedure Steps with a single code in the SPC or with multiple codes in the SPC.

3065 The modality operator shall be able to either accept the protocol proposed by the set of Protocol Codes or select one or more alternative protocol defined on the Modality. The operator shall not be forced to manually enter the attributes of the acquisition protocol as in the Manual Modality

3070 Setting. The Assisted Acquisition Protocol Setting Option simplifies the operator's work on the modality and enables a better management of the protocols used in an imaging department. This option may provide benefits for charge posting.

When multiple Scheduled Protocol Codes are present in the SPC Sequence, each Scheduled Protocol Code shall be analyzed independently (i.e., not as a compound code). It follows that:

- 3075 • The modality settings resulting from the simultaneous processing of the ordered set of Protocol Codes is semantically equivalent to the sequential processing of each Protocol Code independently. In other words, no additional semantics may be inferred from the simultaneous processing of multiple Protocol Codes in the sequence, and
- Protocol Codes shall be proposed to the operator in the order defined in the sequence. The Operator may choose to perform this sequence of Protocol Codes in a different order than scheduled, omit performing some of the protocol codes or include others.

3080 Whether the Scheduled Procedure Step includes one or several Protocol Codes, each Protocol Code shall be processed according to the Protocol Codes defined in the Modality Protocol Code Table. This table shall also be used for an interactive function that lets the user select protocols without manual text entry in the following manner:

- 3085 • If a match is found, the modality settings defined in the Modality Protocol Code Table shall be proposed to the operator. The operator may then choose to:
 - 3090 • Accept the settings (i.e., modality acquisition parameters) proposed. In this case the Performed Protocol Code will take the value of the Scheduled Protocol Code.
 - Accept the settings (modality acquisition parameters) and refine them. (Local policy will determine what refinements are acceptable within a specific protocol code). In this case the Performed Protocol Code will take the value of the Scheduled Protocol Code.
 - Reject the settings proposed and manually select another protocol defined in the Modality Protocol Table. In this case the Performed Protocol Code will take the value of the manually selected Protocol Code (see recommendations in Tables A.1-1 to A.1-5 in Appendix A).
- 3095 • If there is no identical Protocol Code defined in the Modality Protocol Table, the Acquisition Modality must alert the operator.
- A Modality Protocol Code Table shall be configurable on the Acquisition Modality.

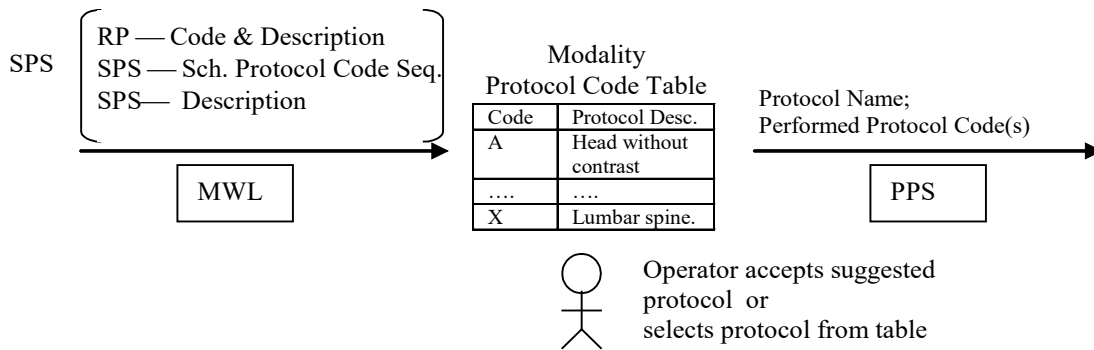

3100 When the ASSISTED ACQUISITION PROTOCOL SETTING Option is supported by the Acquisition Modality, one or more values for the Performed Protocol Code Sequence shall be provided in addition to the Protocol Name. If multiple Protocol Codes have been selected and the corresponding acquisitions performed, the order of the Protocol Codes in the sequence shall reflect the order in which they were performed. This order may differ from the order in which they appeared in the Scheduled Protocol Code Sequence.

3105 The ASSISTED ACQUISITION PROTOCOL SETTING Option does not define a specific codification of acquisition protocols. The Acquisition Modality shall be configurable in order to support the codification scheme selected or defined by the healthcare enterprise.

4.6.4.1.3 Expected Actions

3110 The Department System Scheduler/Order Filler, Report Manager and the Image Manager/Image Archive receive information from the Performed Procedure Step Manager and link it with the Requested Procedure and Scheduled Procedure Step. If the Requested Procedure ID is transmitted empty (Unscheduled Performed Procedure Step case), the Department System Scheduler/Order Filler and the Image Manager shall create an exception that must be manually resolved to link the Performed Procedure Step to the appropriate procedure.

3115

4.7 Modality Procedure Step Completed/Discontinued [RAD-7]

This section corresponds to Transaction RAD-7 of the IHE Technical Framework. Transaction RAD-7 is used by the Department System Scheduler/Order Filler, Image Manager, Report Manager, Performed Procedure Step Manager and Acquisition Modality Actors.

3120 4.7.1 Scope

This transaction includes a message from the Acquisition Modality to the Performed Procedure Step Manager, which in turn issues messages to the DSS/Order Filler, the Report Manager and the Image Manager that the Performed Procedure Step has been completed. Information is not being released for billing at this point but a code may be assigned. The Image Manager may need the information to co-locate images of the same study. The Modality Procedure Step Completed message does not necessarily mean that the set of images is complete or available for retrieval.

4.7.2 Use Case Roles

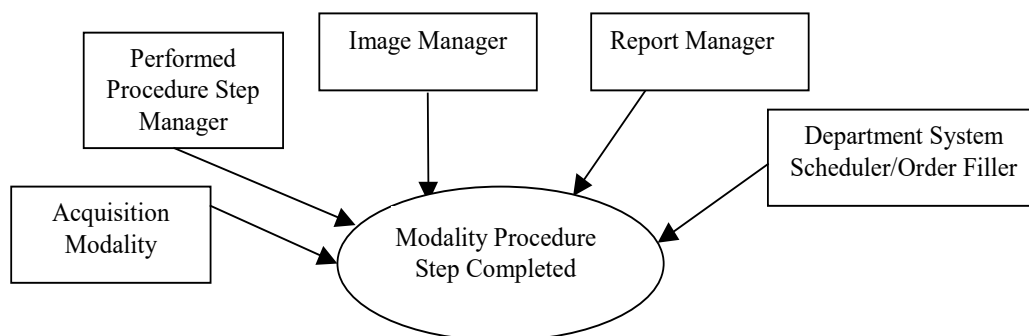

Actor: Department System Scheduler/Order Filler

3130 **Role:** Receives the PPS information forwarded by the PPS Manager

Actor: Image Manager.

Role: Receives the PPS information forwarded by the PPS Manager

Actor: Report Manager

Role: Receives the PPS information forwarded by the PPS Manager

3135 **Actor:** Acquisition Modality

Role: Informs the Performed Procedure Step Manager that a particular Performed Procedure Step is completed

Actor: Performed Procedure Step Manager

3140 **Role:** Accepts Performed Procedure Step information from an Acquisition Modality and transmits it to the Department System Scheduler/Order Filler, Image Manager and Report Manager

4.7.3 Referenced Standards

DICOM PS 3.4: Modality Performed Procedure Step SOP Class.

DICOM PS 3.16: DCMR Context Groups (Normative)

3145 4.7.4 Interaction Diagram

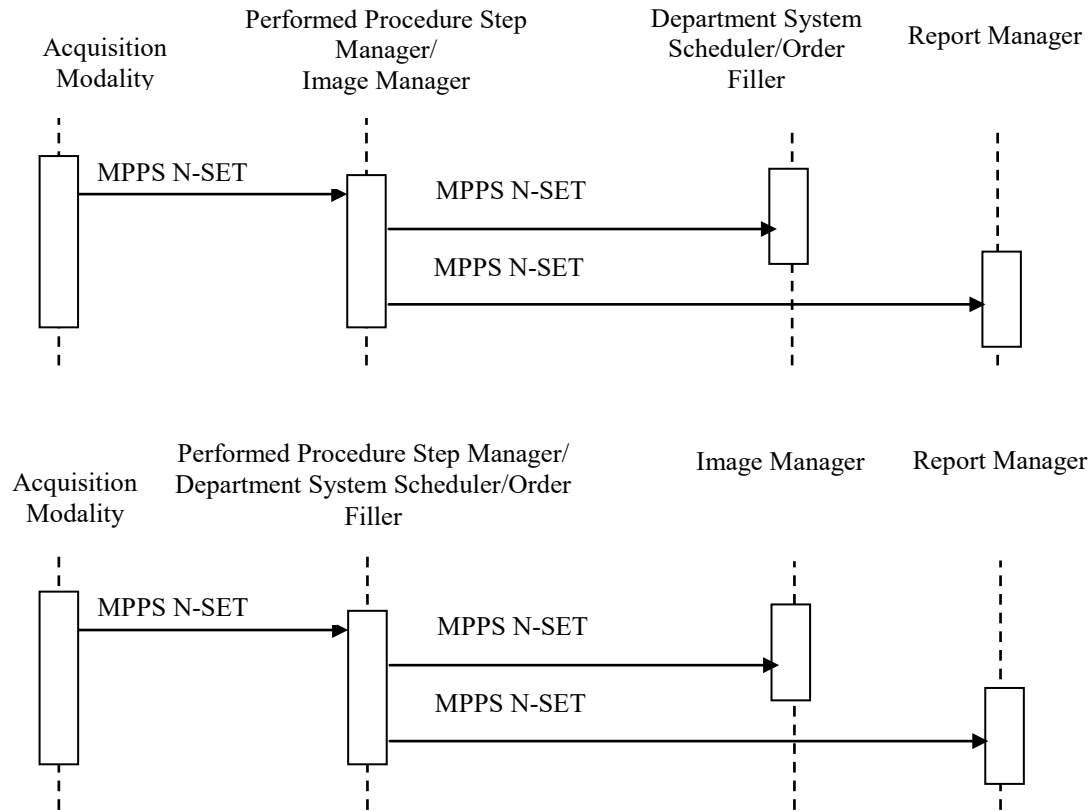

3150 Note: The diagram above shows the sequencing of messages for the Modality Performed Procedure Step SOP Class. Acquisition Modalities will also implement the Storage and Storage Commitment classes. The timing relationship between PPS messages and Storage and Storage Commitment messages is not specified. That is, PPS messages may occur before or after storage requests.

4.7.4.1 Procedure Step Completed/Discontinued

4.7.4.1.1 Trigger Event

3155 Technologist completes procedure step from the Acquisition Modality console.

4.7.4.1.2 Message Semantics

The Acquisition Modality uses the Modality Performed Procedure Step SOP Class (N-SET service) to inform the Performed Procedure Step Manager that a specific Performed Procedure

3160 Step has been completed or discontinued. The Acquisition Modality may use the MPPS N-SET service to send intermediate updates of the Performed Procedure Step information.

The final N-SET has either the MPPS status of "COMPLETED" or "DISCONTINUED". The Performed Procedure Step Manager sends corresponding N-SETs to the Department System Scheduler/Order Filler, Image Manager and Report Manager.

3165 When an N-SET is issued with a "DISCONTINUED" status, one or more Series of Instances may be referenced, if images were created and sent. Those Instances shall be Stored and Storage Committed

Along with other information, the Acquisition Modality shall transmit information about the protocol it used to produce the SOP instances to the recipients. See Protocol Handling in Section 4.6.4.1.2.4 for detailed discussion of this issue.

3170 Note: DICOM specifies that when attributes are allowed to be set by an N-SET, the value provided by the last N-SET overrides any value set by an earlier N-CREATE or N-SET.

4.7.4.1.2.1 Retrieve AE Title

3175 According to the DICOM Standard, the Acquisition Modality has the ability to include the Retrieve AE Title attribute (0008,0054) in the Performed Series Sequence (0040,0340). This is an AE Title where the referenced SOP instances for the series may be retrieved. This Retrieve AE Title will often be of zero length or be of short-term validity, due to the following situations:

- If an Acquisition Modality supports a Retrieve SOP Class in an SCP Role, the modality Retrieve AE Title may be included; however, the modality does not guarantee long-term availability.
- 3180 • A Retrieve AE Title of the Image Manager can be configured on the Acquisition Modality. Otherwise, this field shall be sent zero length. Acquisition Modality implementers shall not assume that the destination AE Title used for the Storage SCP or Storage Commitment SCP is the same as that for Image Retrieval.
- 3185 • An Acquisition Modality may receive the Retrieve AE Title in a Storage Commitment Message (N-EVENT REPORT). However, this information may be received well after the MPPS N-SET (Complete) was performed.

4.7.4.1.2.2 PPS Exception Management Option

3190 When an Acquisition Modality supports the PPS EXCEPTION MANAGEMENT Option, it shall provide the appropriate reason codes (often selected by the operator) in the final N-SET sent with the status of DISCONTINUED.

When the Modality Procedure Step is sent with the Status DISCONTINUED, the Modality Procedure Step Discontinuation Reason Code Sequence (0040,0281) shall be sent with one of the values defined in DICOM PS 3.16 Annex B.

3195

Table 4.7-1: Context ID 9300 – Procedure Discontinuation Reasons

Most Restrictive Use: Defined

Coding Scheme Designator (0008,0102)	Code Value (0008,0100)	Code Meaning (0008,0104)
DCM	110500	Doctor cancelled procedure
DCM	110501	Equipment failure
DCM	110502	Incorrect procedure ordered
DCM	110503	Patient allergic to media/contrast
DCM	110504	Patient died
DCM	110505	Patient refused to continue procedure
DCM	110506	Patient taken for treatment or surgery
DCM	110507	Patient did not arrive
DCM	110508	Patient pregnant
DCM	110509	Change of procedure for correct charging
DCM	110510	Duplicate order
DCM	110511	Nursing unit cancel
DCM	110512	Incorrect side ordered
DCM	110513	Discontinued for unspecified reason
DCM	110514	Incorrect worklist entry selected
DCM	110515	Patient condition prevented continuing
DCM	110516	Equipment change
DCM	110521	Objects incorrectly formatted
DCM	110522	Object Types not supported
DCM	110523	Object Set incomplete
DCM	110524	Media Failure

The Reason Code when communicated to the DSS/Order Filler and Image Manager/Archive may imply canceling an order. It may also facilitate more accurate charge posting.

3200

The Reason Code: “Incorrect Worklist Entry Selected” is used by the Acquisition Modality to convey that the wrong SPS has been selected (incorrect patient or incorrect Requested procedure/order for the same patient). In this case some or all of the incorrectly acquired images (for example the ones assigned to the wrong patient) may already have been stored to the image manager (see Section 4.7.4.1.3.1).

3205

Modality implementers are left free to decide how to correct the incorrectly acquired images. The Acquisition Modality shall include within the MPPS the list of images that are or will be included in the Images Stored Transaction(s).

3210

Note: When a PPS DISCONTINUED is sent with the reason code "incorrect worklist entry selected", images referenced in this PPS DISCONTINUED are images that may have been sent to the Image Manager/Archive. The IHE Technical Framework does not specify whether or not the Acquisition Modality needs to perform a Storage Commitment for these instances.

4.7.4.1.2.3 Billing and Material Management Information

3215 The message semantics are defined in the DICOM Service Class section of the DICOM Modality Performed Procedure Step SOP Class. It is the responsibility of the Acquisition Modality to ensure that the patient and procedure information is sent to the Department System Scheduler/Order Filler.

The Attributes defined in Table 4.7-2 provide a means to transmit procedure and material management codes from the acquisition modality to the DSS/Order Filler that uses them for calculation of charges to be posted to Charge Processor.

3220 An Acquisition Modality that supports the BILLING AND MATERIAL MANAGEMENT Option shall be able to provide content within at least one of the Billing Procedure Step Sequence, Film Consumption Sequence and Billing Supplies and Devices Sequence.

Table 4.7-2 Billing and Material Management Code Module Attributes

Attribute name	Tag	Attribute Description
Billing Procedure Step Sequence	(0040,0320)	Contains billing codes for the Procedure Type performed within the Procedure Step. The sequence may have zero or more Items See note IHE-1, IHE-2
> Code Value	(0008,0100)	
> Coding Scheme Designator	(0008,0102)	
> Code Meaning	(0008,0104)	
Film Consumption Sequence	(0040,0321)	Information about the film consumption for this Performed Procedure Step. The sequence may have zero or more Items. Note: This is only for films printed from this device. See note IHE-3
>Number of Films	(2100,0170)	Number of films actually printed.
>Medium Type	(2000,0030)	Type(s) of medium on which images were printed.
>Film Size ID	(2010,0050)	Size(s) of film on which images were printed.
Billing Supplies and Devices Sequence	(0040,0324)	Contains billing codes for chemicals, supplies and devices for billing used in the Performed Procedure Step. The sequence may have one or more Items.
>Billing Item Sequence	(0040,0296)	Codes values of chemicals, supplies or devices required for billing. The sequence may have zero or one Items. See note IHE-4
>> Code Value	(0008,0100)	
>> Coding Scheme Designator	(0008,0102)	
>> Code Meaning	(0008,0104)	
>Quantity Sequence	(0040,0293)	Sequence containing the quantity of used chemicals or devices. The sequence may have zero or one Items.
>>Quantity	(0040,0294)	Numerical quantity value.
>>Measuring Units Sequence	(0040,0295)	Unit of measurement. The sequence may have zero or one Items. Baseline CID 82
>>> Code Value	(0008,0100)	

Attribute name	Tag	Attribute Description
>>> Coding Scheme Designator	(0008,0102)	
>>> Code Meaning	(0008,0104)	

- 3225 • (IHE-1) Billing Procedure Step Sequence Attribute shall be present if Modality supports the BILLING AND MATERIAL MANAGEMENT Option. It may be sent zero-length if one of Film Consumption Sequence or Billing Supplies and Devices Sequence is also populated.
- 3230 • (IHE-2) A Modality Billing Code Table shall be configured on the Acquisition Modality. This table shall be synchronized with the Department System Scheduler/Order Filler. The codes provided by the Acquisition Modality might not be the same as the code the Department System Scheduler/Order Filler is required to use when posting Charges to the Charge Processor.
- 3235 • (IHE-3) Film Consumption Sequence shall be present if films have been printed during this Performed Procedure Step. Information provided in Film Consumption Sequence may not be sufficient to properly calculate charges. For example, to take into account quality and sensitivity of film, Department System Scheduler/Order Filler shall obtain additional information before calculating and posting charges to the Charge Processor.
- 3240 • (IHE-4) Different coding schemes may be used for codes of Billing Items, for example, DCMR Context ID 12 - Radiographic Contrast Agent may be used to record quantity of contrast used.

4.7.4.1.2.4 Protocol Handling

See Section 4.6.4.1.2.4 for a description of protocol handling.

4.7.4.1.3 Expected Actions

3245 The Image Manager, Report Manager and Department System Scheduler/Order Filler receive information about the Performed Procedure Step being complete or discontinued. The Image Manager, Report Manager and Department System Scheduler are not required to act on intermediate N-SET messages with the MPPS Status "IN PROGRESS".

3250 The Requested Procedure may be considered complete if all Performed Procedure Steps related to all Scheduled Procedure Steps have been completed (or properly discontinued). Additional new (unscheduled) Performed Steps may be performed at any time, even after the Requested Procedure has been assigned complete scanning status. See relationship between Scheduled and Performed Procedure Steps in Section 4.6.4.1.2.3 for detailed discussion of this issue.

4.7.4.1.3.1 PPS Exception Management Option

3255 When a DSS/Order Filler or Image Manager/Archive supports the PPS EXCEPTION MANAGEMENT Option, it shall use the reason codes in the final N-SET sent with the status of DISCONTINUED.

3260 When the Modality Procedure Step is received with the Status DISCONTINUED, the receiver shall interpret the Performed Procedure Step Discontinuation Reason Code Sequence (0040,0281) values as defined in DICOM (see Table 4.7-1). When received by the Department System Scheduler/Order Filler and the Image Manager/Archive, the Reason Code may indicate the necessity for modification or canceling of an order). With the Reason Code: “Incorrect Worklist Entry Selected”, the Acquisition Modality conveys that the wrong SPS has been selected (e.g., incorrect patient or incorrect Requested procedure/order for the same patient). In this case the Image Manager and Department System Scheduler shall take the appropriate action to ensure that already received incorrect instances (i.e., SOP Instances referenced by this Discontinued PPS) are not mistakenly used. If the images, presentation states, or key image notes are not actually deleted, the Image Manager shall:

- not return SOP Instance UIDs for the images in query responses
- not return such images in Patient, Study, Series, or Instance level retrievals

3270 On the DSS and Image Manager, the Order/Requested Procedure status shall be corrected to indicate that the discontinued PPS (with wrong worklist entry selected) is not valid. Therefore the Order Filler/Department System Scheduler shall not query for those instances with an Image Availability transaction.

4.7.4.1.3.2 Billing and Material Management Information

3275 When Billing and Material Management information is provided in the MPPS N-SET, the DSS/Order Filler shall use the billing codes and material usage information provided in the final N-SET for calculation of charges that it will eventually post to the Charge Processor. It is recommended that DSS/Order Filler verifies the consistency of provided billing codes with Requested Procedure Code and Performed Procedure Step Protocol codes supplied in the same N-SET.

3280

4.8 Modality Images Stored [RAD-8]

This section corresponds to Transaction RAD-8 of the IHE Technical Framework. Transaction RAD-8 is used by the Image Archive and Acquisition Modality Actors.

3285 4.8.1 Scope

In the Modality Images Stored transaction, the Acquisition Modality sends the acquired images to the Image Archive. The information provided from the Modality Worklist transaction (see Section 4.5) shall be included in the headers of the generated images.

4.8.2 Use Case Roles

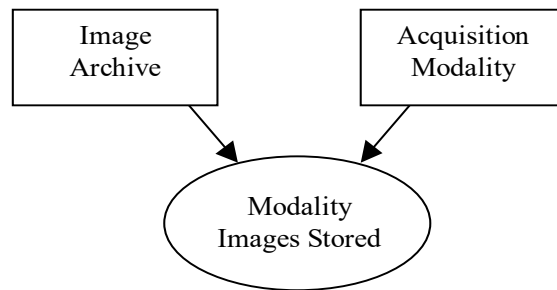

3290

Actor: Acquisition Modality

Role: Transmit acquired image data to Image Archive.

Actor: Image Archive

Role: Accept and store images from Acquisition Modalities.

3295 4.8.3 Referenced Standards

DICOM PS 3.4: Storage Service Class.

4.8.4 Interaction Diagram

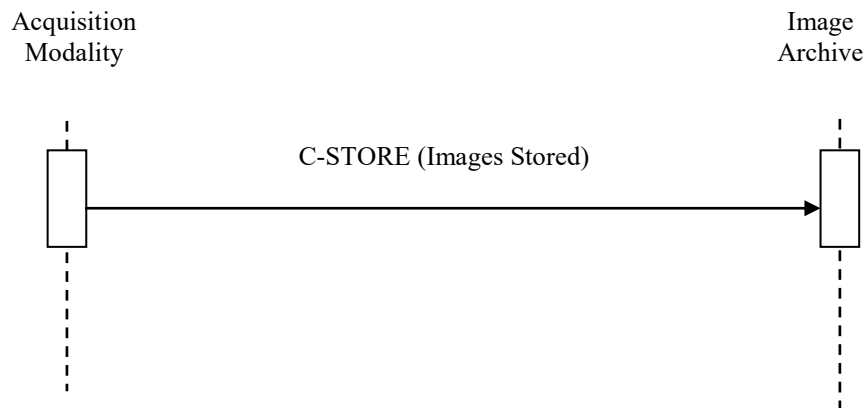

4.8.4.1 Images Stored

3300 4.8.4.1.1 Trigger Events

The Acquisition Modality can transfer images to the Image Archive sequentially within one or more DICOM associations, as the images become available or collectively.

4.8.4.1.1.1 Study UIDs and Series UIDs

3305 Study UID creation details and timing are clearly defined by the IHE. The Scheduled Workflow and Patient Reconciliation Profiles explain how the Study information and identifiers such as the Study Instance UID are generated by the Order Filler and made available to the modality through the Modality Worklist. Generation of these items by the modality or workstation are restricted in general and are only permitted in specifically outlined exception cases, when a PPS is unscheduled (Appendix A, Table A.1-2) or when several SPS belonging to different Requested
3310 Procedures are satisfied by a single PPS (Appendix A, Table A.1-5).

Series UID creation must be compatible with a number of DICOM rules.

Multiple performed procedure steps are not permitted to reference the same series. So conversely, one series cannot contain the output of different performed procedure steps. Therefore, adding images to a series in a procedure step which has been completed is not
3315 permitted since a procedure step cannot be modified.

Note that a series *may* fulfill more than one *scheduled* procedure step. This is referred to in IHE as the group case.

Adding images after completion of a procedure step shall trigger the creation of a new series.

3320 One series cannot contain the output of different equipment (in part because a series must have a single Frame Of Reference). Creating images on different equipment shall trigger the creation of a new series.

All images in a series must share the same Frame Of Reference. Generally this means creating images with different patient positioning shall trigger the creation of a new series. Note that if the Frame Of Reference is not present (at the Series level), this requirement is avoided.

3325 Images reconstructed on a different piece of equipment are required to be in a separate Series.

For consistency, IHE specifies that reconstructed images shall be stored in a separate series from the acquired tomographic images from which they were reconstructed regardless of whether they are reconstructed on the Acquisition Modality or an Evidence Creator.

4.8.4.1.2 Message Semantics

3330 The Acquisition Modality uses the DICOM C-STORE message to transfer the images. The Acquisition Modality is the DICOM Storage SCU and the Image Archive is the DICOM Storage SCP.

3335 The technologist validates the available information for the patient and the Scheduled Procedure Step/Requested Procedure. It is a requirement that certain information be recorded in the image header. The details of the mapping to DICOM image instances are specified in appendix A. Effectively, this appendix strengthens the type definition of some DICOM attributes for the IHE Technical Framework.

4.8.4.1.2.1 Storage of Localizer Images (MR and CT)

3340 In addition to these general mapping requirements, in MR and CT images the relationship between localizer or plan images and related slice images shall be recorded when such slice images were planned or prescribed from the localizer or plan images. In this case, the attribute Referenced Image Sequence (0008,1140) of the slice image shall refer to the related localizer or plan image(s). The coordinate space for this set of related images shall be the same, which is indicated by having a single value for the attribute Frame of Reference UID (0020,0052). For CT images the slice images shall have the value AXIAL in the attribute Image Type, and the localizer image the value LOCALIZER. For MR images no specific value for image type is used to further qualify the relationship between plan and related slice images. The Acquisition Modality shall not use the method of burning-in localizer lines in the pixel sample values (pixel sample value is the "bits stored" part of the pixel data) of the localizer or plan image(s).

3350 Image Display Actors that want to show the localizer lines will be able to calculate the position of these lines of intersection (if visible) based on the information recorded in the images by the Acquisition Modality.

4.8.4.1.2.2 Storage of NM Images (NMI)

3355 Systems supporting the NM Image Profile are required to support a number of attributes as described in the following tables and text. Many of these requirements build on attributes which are Type 2 or Type 3 in DICOM (such attributes are indicated with R+).

Note that the NM Image Profile is undergoing revision, and vendors considering implementation are advised to include the modifications contained in the trial implementation version "NM

3360 Image Profile with Cardiac Option”. For additional information please contact the IHE Radiology Technical Committee at IHE-Rad-Tech@googlegroups.com.

This section is referred to in the Creator Images Stored transaction (Section 4.18) and so the Evidence Creator may also be referred to in the text here.

Table 4.8-2: Required Attributes in Nuclear Medicine Images

Attribute	Tag	Image Type									
		General					Cardiac				
		STATIC	DYNAMIC	WHOLE BODY	GATED	TOMO	RECON TOMO	TOMO	RECON TOMO	GATED TOMO	RECON GATED TOMO
Detector Information Sequence	(0054,0022)										
> Image Position	(0020,0032)						R+		R+		R+
> Image Orientation	(0020,0037)					R+	R+	R+	R+	R+	R+
> View Code Sequence	(0054,0220)										
>> Code Value	(0008,0100)			R+					R ⁺¹		R ⁺¹
>> Coding Scheme Designator	(0008,0102)			R+					R ⁺¹		R ⁺¹
Slice Progression Direction	(0054,0500)								R ⁺²		R ⁺²
Spacing Between Slices	(0018,0088)						R ⁺⁴		R ⁺⁴		R ⁺⁴
Acquisition Context Sequence	(0040,0555)										
> Concept-Name Code Sequence	(0040,A043)							R ⁺³	R ⁺³	R ⁺³	R ⁺³
> Concept Code Sequence	(0040,A168)							R ⁺³	R ⁺³	R ⁺³	R ⁺³
Frame of Reference UID	(0020,0052)					R+	R+	R+	R+	R+	R+

3365 Note 1: Required for images from one of the standard cardiac views: Short Axis, Vertical Long Axis, or Horizontal Long Axis. For a definition of these terms and the implied orientation of the heart in the frame (refer to Nuclear Cardiology Nomenclature, Cequeria MD, et al, Journal of Nuclear Cardiology, 2002, 9:240-245). The Code Values shall be taken from Context ID 26 (relevant codes are shown here):

Coding Scheme Designator	Code Value	Code Meaning
SNM3	G-A186	Short Axis
SNM3	G-A18A	Vertical Long Axis
SNM3	G-A18B	Horizontal Long Axis

3370 Note 2: Slice Progression Direction is required for Images in which the View Code Sequence indicates Short Axis views. The DICOM defined values are APEX_TO_BASE and BASE_TO_APEX.

3375 Note 3: The Acquisition Context Module and the Acquisition Context Sequence (0040,0555) contained within it are required for cardiac stress/rest images. As defined in the Standard, the Concept Name Code Sequence (0040,A043) shall contain (DCM, 109054, “Patient State”) and the Concept Code Sequence (0040,A168) shall use values from the following list:

Coding Scheme Designator	Code Value	Code Meaning
SRT	F-01604	Resting State
DCM	109091	Cardiac Stress State
DCM	109092	Reinjection State
DCM	109093	Redistribution State
DCM	109094	Delayed Redistribution State

Note 4: The ‘Spacing Between Slices’ attribute is required by IHE to contain a valid value for the RECON image types.

3380 It is recommended that when multiple energy windows are present that descriptive values be provided for the following attributes: Energy Window Name (0054,0018), Energy Window Lower Limit (0054,0014) and Energy Window Upper Limit (0054,0015).

It is recommended that when multiple detectors are present that descriptive values be provided in the codes contained in the View Code Sequence (0054,0220).

3385 It is recommended that when multiple phases are present that descriptive values be provided for the Phase Description (0054,0039).

3390 The Acquisition Modality or Evidence Creator shall be capable of encoding the data for NM images with Image Type (0008,0008) equal to TOMO or GATED TOMO as if it were created on a single detector system. This means setting the Number of Detectors (0054,0021) to 1 and reordering the frame data to be consistent with acquisition by a single detector system regardless of the number of actual detectors used to acquire the image data. The system may additionally support encoding the data with the actual detector configuration.

3395 When the Image Type (0008,0008) is RECON TOMO or RECON GATED TOMO, the Image Position (0020,0032), Image Orientation (0020,0037), and the View Code Sequence (0054,0220) shall describe the orientation of the reconstructed frames within the Image.

3400 When the Image Type (0008,0008) is TOMO or RECON TOMO or GATED TOMO or RECON GATED TOMO, the Frame of Reference UID (0020,0052) Attribute shall be present with a value and describe the patient-relative frame of reference in which Image Position (Patient) (0020,0032) and Image Orientation (Patient) (0020,0037) are defined, for the purpose of allowing correlation with other images in the same frame of reference.

When the Image Type (0008,0008) is WHOLE BODY, the useful image data is generally rectangular in shape (e.g., 256x1024). Acquisition Modalities and Evidence Creators shall be capable of creating these images without padding to create square frames.

3405 Although the DICOM standard does not rigorously specify the order of frames in the image object, the following practice is commonly used and is required by the NM Image Profile:

Images shall be stored with the frames sorted into “vector sorted order”. That is, the frames shall be ordered such that the frames are sorted first by the values of the first vector, then within a value for the first vector, the frames are sorted by the values of the second vector, etc. This order is referred to in this document as “vector sorted order”.

3410 For details on vectors and examples of “vector sorted order”, refer to RAD TF-1: Appendix E.4.2 NM Image IOD: Multi-Frames & Vectors.

4.8.4.1.2.3 Storage of Full Field Digital Mammography Images

3415 When participating in the Modality Images Stored transaction and the Mammography Image Integration Profile, the Acquisition Modality that creates in vivo clinical full field digital mammography images, whether using a digital detector, by computed radiography, or by digitizing film, shall use the DICOM Digital Mammography X-Ray Image IOD, and shall supply the attributes with the additional requirements presented in Table 4.8.4.1.2.3-1.

3420 The less stringent requirements for Attributes for digitized film in Table 4.8.4.1.2.3-1 apply only if the intent of digitization is not for primary diagnosis, but for other purposes such as CAD and use as priors for comparison, since additional information otherwise required may not obtainable at the time of digitization.

Table 4.8.4.1.2.3-1: Required Additional Attributes in Mammography Images

Attribute	Tag	DX, CR	Film	Rationale
Patient’s Name	(0010,0010)	R+	R+	Used for identification during display
Patient ID	(0010,0020)	R+	R+	Used for identification during display
Patient’s Birth Date	(0010,0030)	R+	O	Used for identification during display
Patient’s Age	(0010,1010)	R+	O	Used for identification during display
Acquisition Date	(0008,0022)	R+	R+	Used for identification during display
Acquisition Time	(0008,0032)	R+	O	Used for identification during display
Operator’s Name	(0008,1070)	R+	O	Used for identification during display
Manufacturer	(0008,0070)	R+	O	Used for quality control display
Institution Name	(0008,0080)	R+	O	Used for identification during display

Attribute	Tag	DX, CR	Film	Rationale
Institution Address	(0008,0081)	R+	O	Used for quality control display
Manufacturer's Model Name	(0008,1090)	R+	O	Used for quality control display
Device Serial Number	(0018,1000)	R+	O	Used for quality control display
Detector Type	(0018,7004)	R+	R+	Used to distinguish scanned film; Type 2 in DICOM, but in IHE MAMMO shall not be empty and shall contain a Defined Term provided in the standard
Detector ID	(0018,700A)	R+	O	Used for quality control display; this attribute in the Mammography IOD replaces the function in the CR IOD of Plate or Cassette ID for a CR mammography system
Software Versions	(0018,1020)	R+	O	Used for CAD systems to be sure that processing is appropriate to the software version that created the images.
Station Name	(0008,1010)	R+	O	Used for identification of the system that acquired the images during display.
Gantry ID	(0018,1008)	RC+	O	Used for identification of the system that acquired the images during display. Required for images acquired by CR, since the Station Name (0008,1010) will normally identify the plate reader, not the acquisition device.
Source Image Sequence	(0008,2112)	R+	O	Needed to allow Image Displays to apply CAD marks to for presentation images when CAD was performed on for processing images
>Spatial Locations Preserved	(0028,135A)	R+	O	Needed to allow Image Displays to apply CAD marks to for presentation images when CAD was performed on for processing images; see also DICOM CP 564. Shall be YES if only a flip or rotation of the image pixel data has been performed.
KVP	(0018,0060)	R+	O	Used for display of the kVP technical factor
Exposure	(0018,1152)	R+	O	Used for display of the mAs technical factor
Exposure Time	(0018,1150)	R+	O	Used for display of the exposure time technical factor
Filter Material	(0018,7050)	R+	O	Used for display of the filter technical factor
Anode Target Material	(0018,1191)	R+	O	Used for display of the target technical factor
Compression Force	(0018,11A2)	R+	O	Used for display of the compression force technical factor
Body Part Thickness	(0018,11A0)	R+	O	Used for display of the compressed breast thickness technical factor
Positioner Primary Angle	(0018,1510)	R+	O	Used for display of the degree of obliquity technical factor
Relative X-ray Exposure	(0018,1405)	R+	O	Used for the display of the relative exposure technical factor. Note that Sensitivity (0018,6000) is NOT used for this purpose.

Attribute	Tag	DX, CR	Film	Rationale
Entrance Dose in mGy	(0040,8302)	R+	O	Used for display of the estimated skin dose technical factor. Note that this attribute is used instead of the less precise (0040,0302) whose integer value is in dGy units.
Organ Dose	(0040,0316)	R+	O	Used for the display of the estimated mean glandular dose technical factor
VOI LUT Sequence	(0028,3010)	C	C	Required if Window Center and Width not present
>LUT Explanation	(0028,3003)	RC+	RC+	Required if more than one sequence item or at least one sequence item and window center/width pair is present in order to allow Image Display to present to the user a selection of LUTs or windows described by the explanation.
Window Center and Width Explanation	(0028,1055)	RC+	RC+	Required if more than one VOI LUT Sequence item or window center/width pair and at least one VOI LUT Sequence item is present in order to allow Image Display to present to the user a selection of LUTs or windows described by the explanation.
VOI LUT Function	(0028,1056)	RC+	RC+	Required if Window Center and Width are not intended to be interpreted as parameters of a linear function in order to allow Image Display to perform appropriate contrast transformation. Enumerated Values LINEAR or SIGMOID. See DICOM CP 467.
Burned In Annotation	(0028,0301)	R	R	Shall have the enumerated value of "NO", unless the image was obtained by film digitization.
Implant Present	(0028,1300)	R+	O	Used to control hanging and processing (including CAD); not identical to Implant Displaced value for View Modifier Code Sequence, since an implant may be present but not displaced.
Pixel Padding Value	(0028,0120)	RC+	RC+	Required if background air suppression has been performed by replacing the pixels with a value not used within the breast tissue, so that pixels with this value can be excluded from contrast transformations. May be present otherwise. See 4.8.4.1.2.3.2.
Pixel Padding Range Limit	(0028,0121)	RC+	RC+	Required if Pixel Padding Value (0028,0120) is present and the padding values are a range rather than a single value. See 4.8.4.1.2.3.2.
Estimated Radiographic Magnification Factor	(0018,1114)	R+	O	Used to adjust Imager Pixel Spacing (0018,1164) to account for geometric magnification for normal and magnified views when making distance measurements and displaying or printing calipers.
Date of Last Detector Calibration	(0018,700C)	RC+	O	Used for quality control display. Required if detector undergoes periodic calibration (e.g., may not be applicable for CR).

See Section 2.2 DICOM Usage Conventions.

4.8.4.1.2.3.1 Partial View Option

3425 The Partial View Option requires that the Acquisition Modality always send a flag indicating whether or not the image is part of a set of images (a mosaic) used to cover the area of a breast that is larger than the detector, and which part of the set the image represents.

The Partial View (0028,1350) Attribute shall be sent and have a value of NO for magnification and spot compression images.

3430 **Table 4.8.4.1.2.3.1-1: Required Additional Attributes in Mammography Images for the Partial View Option**

Attribute	Tag	IHE	Rationale
Partial View	(0028,1350)	R+	Required to control hanging of mosaics.
Partial View Code Sequence	(0028,1352)	RC+	Required if Partial View (0028,1350) has a value of YES, to control hanging of mosaics.

4.8.4.1.2.3.2 Background Air Suppression

3435 For full field images (but not magnification or specimen images), the Acquisition Modality shall detect air outside the breast or the skin line, so as to provide for image contrast adjustment of the breast without adjusting the contrast of the background, and shall encode the region of the background to be excluded in “For Presentation” images by one of two means:

- a single Pixel Padding Value (0028,0120) that is used to indicate a value in the pixel data that is outside the breast
- 3440 • a range of pixel values between Pixel Padding Value (0028,0120) and Pixel Padding Range Limit (0028,0121) inclusive that is used to indicate values in the pixel data that are outside the breast

The air suppression mechanism used shall not obscure any burned in lead markers present in the image.

3445 **4.8.4.1.2.3.3 Cleavage Views**

In a cleavage view that is not centered between both breasts or for which the operator designates one breast as primary, then the value of Image Laterality (0020,0062) shall be “L” or “R”, rather than “B”.

4.8.4.1.2.3.4 Digitized Film

3450 The Digital Mammography X-Ray Image IOD, not the Secondary Capture Image IOD, shall be used for digitized film. Presentation Intent Type (0008,0068) shall be FOR PRESENTATION. Detector Type (0018,7004) shall be “FILM”.

The values of the pixel size encoded in Imager Pixel Spacing (0018,1164) shall be the physical distance on the film being digitized or scanned between the center of each pixel.

3455 The Study Date (0008,0020), Study Time (0008,0030), Acquisition Date (0008,0022) and Acquisition Time (0008,0022) shall be the date and time of acquisition of the film-screen exposure, not when the film was digitized.

Burned In Annotation (0028,0301) shall be present and may have a value of YES if the digitized image contains patient identification information.

3460 There are no specific requirements in this transaction for the reconciliation of identifiers during digitization. However, the Acquisition Modality may be grouped with an Importer in the Import Reconciliation Workflow Integration Profile.

3465 The output of the grayscale pipeline in a Digital Mammography X-Ray Image IOD FOR PRESENTATION image is always in P-Values; therefore the optical density values obtained during film digitization shall be converted to P-Values, using appropriate assumed viewing conditions for the original film.

4.8.4.1.2.4 Recording of Dose Information

3470 Acquisition Modality Actors claiming the Radiation Exposure Monitoring (REM) Profile shall record the Irradiation Event UID (0008,3010) of the event(s) that resulted in the data from which the image was derived in each image created; if the image or frame is derived from more than one irradiation event, multiple values shall be present (see DICOM CP 1090). The value(s) of the Irradiation Event UID shall match those encoded in the corresponding SR Dose Information instance. If the SR Dose Information instance is not being created by the equipment that actually administered the radiation, the equipment creating the SR Dose Information shall assure that all images contain the correct Irradiation Event UIDs.

3475 The Irradiation Event UIDs may be used to identify images corresponding to irradiation events for purposes such as identifying irradiated tissues and organs for dose mapping or for advanced effective dose estimations or for comparing the noise characteristics of the images with the dose.

3480 The Irradiation Event UIDs (0008,3010) shall be included in both original and derived images produced by the Acquisition Modality (such as retrospective reconstructions from the same raw data with different slice thickness or reconstruction intervals, multi-planar or 3D reconstructions from the same irradiation event, as well as for processing and for presentation projection images).

3485 For further information on Irradiation Events, see RAD TF-3: 4.62 Store Dose Information, and RAD TF-1: 22 Radiation Exposure Monitoring Profile.

4.8.4.1.2.5 Storage of Enhanced DICOM Objects

This section intentionally, temporarily left blank.

4.8.4.1.2.6 Storage of Stereotactic Mammography Images

This section intentionally, temporarily left blank.

3490 **4.8.4.1.2.7 Storage of Digital Breast Tomosynthesis Images**

The Acquisition Modality in the Digital Breast Tomosynthesis Profile shall support the DICOM Breast Tomosynthesis Image Storage SOP Class and the additional attributes specified in Table 4.8.4.1.2.7-2 and Table 4.8.4.1.2.7-3.

3495 If conventional 2D mammography images are acquired, the Acquisition Modality shall support the Digital Mammography X-Ray Image Storage - For Presentation and For Processing SOP Classes and the additional attributes specified in Table 4.8.4.1.2.3-1.

Acquisition Modalities capable of creating generated 2D images mathematically from tomosynthesis data (e.g., by Maximum Intensity Projection) shall encode them using the Breast Tomosynthesis Image Storage SOP Class.

3500 The Acquisition Modality is not required to use Stacks, or the Multi-frame Dimensions Module, but is not prohibited from doing so. Concatenations are forbidden. In order to distinguish the different types of tomosynthesis images, the Image Type (0008,0008) attribute shall be populated according to Table 4.8.4.1.2.7-1.

Table 4.8.4.1.2.7-1: Image Type in Breast Tomosynthesis Images

Type of tomosynthesis image	Image Type Value 1	Image Type Value 3	Image Type Value 4
Thin Slices	ORIGINAL/DERIVED	TOMOSYNTHESIS	NONE
Thick Slices (Slabs)	DERIVED	TOMOSYNTHESIS	e.g., MAXIMUM, MEAN
Tomosynthesis Generated 2D	DERIVED	TOMOSYNTHESIS	GENERATED_2D

3505 Note: This table is adapted from DICOM CP 1342 and will be finalized after CP 1342 is approved.

Table 4.8.4.1.2.7-2: Required additional attributes for DBT Reconstruction Images

Attribute	Tag	Tomo	Proj	Rationale
Patient's Name	(0010,0010)	R+	R+	Used for identification during display
Patient ID	(0010,0020)	R+	R+	Used for identification during display
Patient's Birth Date	(0010,0030)	R+	R+	Used for identification during display
Patient's Age	(0010,1010)	R+	R+	Used for identification during display
Operators' Name	(0008,1070)	R+	R+	Used for identification during display
Manufacturer	(0008,0070)	R	R	Used for quality control display
Institution Name	(0008,0080)	R+	R+	Used for identification during display
Institution Address	(0008,0081)	R+	R+	Used for quality control display
Manufacturer's Model Name	(0008,1090)	R	R	Used for quality control display
Device Serial Number	(0018,1000)	R	R	Used for quality control display
Station Name	(0008,1010)	R+	R+	Used for identification of the system that acquired

Attribute	Tag	Tomo	Proj	Rationale
				the images during display

Table 4.8.4.1.2.7-3: Required Additional Attributes for DBT Reconstruction Images (Breast Tomosynthesis Image SOP Class)

Attribute	Tag	Tomo	Rationale
Image Type	(0008,0008)	R	Used for display in order to distinguish between different reconstructions
Number of Frames	(0028,0008)	R	Used for display during scrolling
X-Ray 3D Reconstruction Sequence	(0018,9530)	RC+	Type 1 in Type U X-Ray 3D Reconstruction Module. Required if the image represents an additional reconstruction (e.g., slabs) Note: If the X-Ray 3D Reconstruction Sequence is sent, all other mandatory attributes need to be sent as well
>Reconstruction Description	(0018,9531)	RC+	Used to display the way how reconstructed images were generated. Shall be required for additional reconstructions (e.g., slabs)
Pixel Padding Value	(0028,0120)	RC+	Required if background air suppression has been performed by replacing the pixels with a value not used within the breast tissue, so that pixels with this value can be excluded from contrast transformations. May be present otherwise. See Section 4.8.4.1.2.3.2
Pixel Padding Range Limit	(0028,0121)	RC+	Required if Pixel Padding Value (0028,0120) is present and the padding values are a range rather than a single value. See Section 4.8.4.1.2.3.2
Breast Implant Present	(0028,1300)	R	Used to control hanging and processing; not identical to Implant Displaced value for View Modifier Code Sequence, since an implant may be present but not displaced
Frame VOI LUT With LUT Functional Macro (could either be in Per-frame Functional Groups Sequence (5200,9230) or in Shared Functional Groups Sequence (5200,9229))			
Frame VOI LUT Sequence	(0028,9132)	R	
>VOI LUT Sequence	(0028,3010)	C	Required if Window Center and Width not present
>>LUT Explanation	(0028,3003)	RC+	Required if more than one sequence item or at least one sequence item and window center/width pair is present in order to allow Image Display to present to the user a selection of LUTs or windows described by the explanation
>Window Center	(0028,1050)	C	Required if VOI LUT Sequence is not present
>Window Width	(0028,1051)	C	Required if VOI LUT Sequence is not present

Attribute	Tag	Tomo	Rationale
>Window Center and Width Explanation	(0028,1055)	RC+	Required if more than one VOI LUT Sequence item or window center/width pair and at least one VOI LUT Sequence item is present in order to allow Image Display to present to the user a selection of LUTs or windows described by the explanation
>VOI LUT Function	(0028,1056)	RC+	Required if Window Center and Width are not intended to be interpreted as parameters of a linear function in order to allow Image Display to perform appropriate contrast transformation. Enumerated Values LINEAR or SIGMOID
Pixel Measures Functional Macro (could either be in Per-frame Functional Groups Sequence (5200,9230) or in Shared Functional Groups Sequence (5200,9229))			
Pixel Measures Sequence	(0028,9110)	R	
>Pixel Spacing	(0028,0030)	RC	Required in order to perform measurements and annotations
>Slice Thickness	(0018,0050)	RC	Used for display
Plane Position (Patient) Functional Group Macro (may be in the Shared Functional Groups Sequence (5200,9229) if only a single frame is present, otherwise will be in the Per-frame Functional Groups Sequence (5200,9230))			
Plane Position Sequence	(0020,9113)	R	
>Image Position (Patient)	(0020,0032)	R	Used to identify location of slice in volume Shall be different for every frame (i.e., one traversal of the volume)
Plane Orientation (Patient) Functional Group Macro (shall be in Shared Functional Groups Sequence (5200,9229))			
Plane Orientation Sequence	(0020,9116)	R	
>Image Orientation (Patient)	(0020,0037)	R	Used for determination of the direction of rows and columns relative to the patient instead of Patient Orientation (0020,0020)
Frame Anatomy Functional Group Macro (shall be in Shared Functional Groups Sequence (5200,9229))			
Frame Anatomy Sequence	(0020,9071)	R	
>Frame Laterality	(0020,9072)	R	Used to describe which breast is imaged; all frames share the same value
Information related to the acquisition of the source projection images			
Breast Tomosynthesis Contributing Sources			
Contributing Sources Sequence	(0018,9506)	R+	Type 1 in Type U Breast Tomosynthesis Contributing Sources Module

Attribute	Tag	Tomo	Rationale
>Detector ID	(0018,700A)	R	Used for quality control display
>Date of Last Detector Calibration	(0018,700C)	R	Used for quality control display
>Acquisition DateTime	(0008,002A)	R+	Used for identification during display
Breast Tomosynthesis Acquisition			
X-Ray 3D Acquisition Sequence	(0018,9507)	R+	Type 1 in Type U Breast Tomosynthesis Acquisition Module
>Source Image Sequence	(0008,2112)	RC	Used to identify breast projection X-Ray images that were used to generate this image
>KVP	(0018,0060)	R	Used for display of the kVp technical factor
>X-Ray Tube Current in mA	(0018,9330)	R	Used for display of the mA technical factor
>Filter Material	(0018,7050)	R	Used for display of the filter technical factor
>Anode Target Material	(0018,1191)	R	Used for display of the target technical factor
>Compression Force	(0018,11A2)	R	Used for display of the compression force technical factor
>Body Part Thickness	(0018,11A0)	R	Used for display of the compressed breast thickness technical factor
>Primary Positioner Scan Start Angle	(0018,9510)	R	Used for display of the degree of obliquity technical factor
>Primary Positioner Scan Arc	(0018,9508)	R	Used for display of the degree of obliquity technical factor
>Exposure in mAs	(0018,9332)	R	Used for display of the mAs technical factor
>Exposure Time in ms	(0018,9328)	R	Used for display of the exposure time technical factor
>Entrance Dose in mGy	(0040,8302)	R+	Used for display of the estimated skin dose technical factor Note: This attribute is added in DICOM CP 1285 (final text)
>Organ Dose	(0040,0316)	R+	Used for the display of the estimated mean glandular dose technical factor Note: This attribute is added in DICOM CP 1285 (final text)

3510

Note: This table is not an exhaustive list of all attributes that are required by DICOM, but highlights those that are referred to elsewhere in the DBT Profile.

Acquisition Modalities participating in the Digital Breast Tomosynthesis Profile may support the following transfer syntaxes as listed in Table 4.8.4.1.2.7-4 for all supported SOP Classes.

3515

Table 4.8.4.1.2.7-4: Compression Transfer Syntaxes in Digital Breast Tomosynthesis Profile

Transfer Syntax UID	Name
1.2.840.10008.1.2.4.51	JPEG Extended (Process 2 & 4): Default Transfer Syntax for Lossy JPEG 12 Bit Image Compression (Process 4 only)
1.2.840.10008.1.2.4.57	JPEG Lossless, Non-Hierarchical (Process 14)
1.2.840.10008.1.2.4.70	JPEG Lossless, Non-Hierarchical, First-Order Prediction (Process 14)
1.2.840.10008.1.2.4.90	JPEG 2000 Image Compression (Lossless Only)
1.2.840.10008.1.2.4.91	JPEG 2000 Image Compression

4.8.4.1.2.7.1 Partial View Option

3520

Acquisition Modalities supporting the Partial View Option in the Digital Breast Tomosynthesis Profile shall fulfill all requirements listed in Section 4.8.4.1.2.3.1 for tomosynthesis reconstructions and 2D images generated mathematically from tomosynthesis data.

4.8.4.1.3 Expected Actions

The Image Archive will store the received DICOM objects.

3525

The DICOM objects shall be stored such that they can be later retrieved (See Section 4.16 Retrieve Images) in a fashion meeting the requirements defined for a DICOM Level 2 Storage SCP (Refer to DICOM PS 3.4 B.4.1).

4.8.4.1.3.1 DICOM Image Storage SOP Classes

The DICOM Standard (2011) defines a number of image specific storage SOP classes. It is expected that Image Archive will support multiple storage SOP classes as defined in Table 4.8-1 below.

3530

Table 4.8-1: Suggested Image SOP Classes

SOP Class UID	SOP Class Name
1.2.840.10008.5.1.4.1.1.1	Computed Radiography Image Storage
1.2.840.10008.5.1.4.1.1.2	CT Image Storage
1.2.840.10008.5.1.4.1.1.4	MR Image Storage
1.2.840.10008.5.1.4.1.1.20	Nuclear Medicine Image Storage
1.2.840.10008.5.1.4.1.1.128	Positron Emission Tomography Image Storage
1.2.840.10008.5.1.4.1.1.481.1	RT Image Storage
1.2.840.10008.5.1.4.1.1.7	Secondary Capture Image Storage
1.2.840.10008.5.1.4.1.1.6.1	Ultrasound Image Storage
1.2.840.10008.5.1.4.1.1.3.1	Ultrasound Multi-frame Image Storage
1.2.840.10008.5.1.4.1.1.12.1	X-Ray Angiographic Image Storage

SOP Class UID	SOP Class Name
1.2.840.10008.5.1.4.1.1.12.2	X-Ray Radiofluoroscopic Image Storage
1.2.840.10008.5.1.4.1.1.1.1	Digital X-Ray Image Storage – For Presentation
1.2.840.10008.5.1.4.1.1.1.1.1	Digital X-Ray Image Storage – For Processing
1.2.840.10008.5.1.4.1.1.1.2	Digital Mammography X-Ray Image Storage – For Presentation
1.2.840.10008.5.1.4.1.1.1.2.1	Digital Mammography X-Ray Image Storage – For Processing
1.2.840.10008.5.1.4.1.1.13.1.3	Breast Tomosynthesis Image Storage
1.2.840.10008.5.1.4.1.1.1.3	Digital Intra-oral X-Ray Image Storage – For Presentation
1.2.840.10008.5.1.4.1.1.1.3.1	Digital Intra-oral X-Ray Image Storage – For Processing
1.2.840.10008.5.1.4.1.1.77.1.1	VL Endoscopic Image Storage
1.2.840.10008.5.1.4.1.1.77.1.2	VL Microscopic Image Storage
1.2.840.10008.5.1.4.1.1.77.1.3	VL Slide-Coordinates Microscopic Image Storage
1.2.840.10008.5.1.4.1.1.77.1.4	VL Photographic Image Storage

Image Manager/Image Archives claiming the NM Image Profile are required to support all of the SOP classes listed in Table 4.8-3 below. Acquisition Modalities claiming the NM Image Profile are required to support Nuclear Medicine Image Storage.

Table 4.8-3: Nuclear Medicine SOP Classes

SOP Class UID	SOP Class Name
1.2.840.10008.5.1.4.1.1.20	Nuclear Medicine Image Storage
1.2.840.10008.5.1.4.1.1.7	Secondary Capture Image Storage
1.2.840.10008.5.1.4.1.1.7.2	Multi-frame Grayscale Byte Secondary Capture Image Storage
1.2.840.10008.5.1.4.1.1.7.4	Multi-frame True Color Secondary Capture Image Storage

3535 Acquisition Modalities shall be capable of providing all created Nuclear Medicine image types using the Nuclear Medicine Image SOP class.

Acquisition Modalities and Image Manager/Image Archives claiming the Mammography Image Profile are required to support all of the SOP classes listed in Table 4.8-4 below.

Table 4.8-4: Mammography SOP Classes for Acquisition and Archival

SOP Class UID	SOP Class Name
1.2.840.10008.5.1.4.1.1.1.2	Digital Mammography Image Storage – For Presentation
1.2.840.10008.5.1.4.1.1.1.2.1	Digital Mammography Image Storage – For Processing

3540 Film digitizers are only required to create “For Presentation” images. All other Acquisition Modalities claiming the Mammography Image Profile shall be capable of sending both “For Presentation” and “For Processing” images for every image stored, though not necessarily to the same target (e.g., “For Processing” images may be sent to the actor corresponding to the CAD device and “For Presentation” images or both to the Image Manager/Archive).

3545 The “For Presentation” images shall contain a reference to the SOP Instance UID of the corresponding “For Processing” image in Source Image Sequence (0008,2112).

The Image Manager/ Image Archive shall be able to accept both “For Processing” and “For Presentation” images from the Acquisition Modality, and make both available for retrieval, but is not required to be able to make “For Processing” images “presentable”.

3550 Acquisition Modalities and Image Manager/Image Archives participating in the Digital Breast Tomosynthesis Profile shall support the SOP classes with the optionality listed in Table 4.8-5.

Table 4.8-5: Digital Breast Tomosynthesis SOP Classes for Acquisition and Archival

SOP Class UID	SOP Class Name	Optionality (Acq. Mod)	Optionality (IM/IA)
1.2.840.10008.5.1.4.1.1.13.1.3	Breast Tomosynthesis Image Storage	R	R
1.2.840.10008.5.1.4.1.1.1.2	Digital Mammography X-Ray Image Storage – For Presentation	O	R
1.2.840.10008.5.1.4.1.1.1.2.1	Digital Mammography X-Ray Image Storage – For Processing	O	R

Image Manager/ Image Archives participating in the Digital Breast Tomosynthesis Profile shall support the compression transfer syntaxes as listed in Table 4.8.4.1.2.7-4.

3555

4.9 Modality Presentation State Stored [RAD-9]

This section corresponds to Transaction RAD-9 of the IHE Technical Framework. Transaction RAD-9 is used by the Image Archive and Acquisition Modality Actors.

3560 4.9.1 Scope

This section describes DICOM Storage requests of Grayscale Softcopy Presentation States issued by the Acquisition Modality to the Image Archive. The Acquisition Modality sends Presentation States for storage along with the images so they can be later used for support of consistent display of imaging data

3565 4.9.2 Use Case Roles

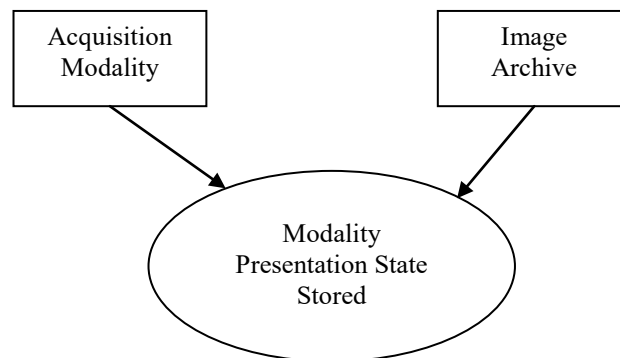

Actor: Acquisition Modality

Role: Generate Grayscale Softcopy Presentation States to be applied to image data. This actor will support the ability to send Presentation State data to an Image Archive.

3570 Actor: Image Archive

Role: Accept and store Grayscale Softcopy Presentation State SOP Instances received from the Acquisition Modality.

4.9.3 Referenced Standards

DICOM PS 3.4: Storage Service Class

3575 DICOM PS 3.4: Grayscale Softcopy Presentation State Storage

DICOM PS 3.14: Grayscale Standard Display Function

4.9.4 Interaction Diagram



4.9.4.1 Modality Presentation State Stored

3580 4.9.4.1.1 Trigger Events

The Acquisition Modality generates a Grayscale Softcopy Presentation State and sends it to the Image Archive for storage. A Presentation State shall be generated as part of a Performed Procedure Step (see Section 4.6.4). It can be either as part of a Simple, Unscheduled, Append, Discontinue or Grouped Cases for which the same requirements as images apply. When
 3585 generated as part of a Presentation of Grouped Procedure Case it shall follow the specific requirements defined in Section 4.6.4.1.2.3.6.

4.9.4.1.2 Message Semantics

The Acquisition Modality uses the DICOM C-STORE message to store Grayscale Softcopy Presentation States. All grayscale processing operations, and all spatial and graphical operations,
 3590 that are relevant to the resulting presentation of the referenced image have to be recorded in the presentation state. This will preserve the "as-last-seen" view of the image, with for example the contrast setting, rotation, flip and text annotation. The image operations in the presentation state override whatever is recorded in the image itself, even in the case that no attributes for a specific operation (e.g., Window Width/Window Level operation) are present in the presentation state.
 3595 The latter case by definition specifies an identity operation. The full message semantics are defined in the Grayscale Softcopy Presentation State Storage SOP Class Behavior section of DICOM PS 3.4. The Acquisition Modality will be the DICOM Storage SCU and the Image Archive will be the DICOM Storage SCP.

4.9.4.1.3 Expected Actions

3600 The Image Archive will store the received Grayscale Softcopy Presentation State objects.

4.10 Storage Commitment [RAD-10]

This section corresponds to Transaction RAD-10 of the IHE Technical Framework. Transaction RAD-10 is used by the Image Manager and Acquisition Modality Actors.

4.10.1 Scope

3605 After the Acquisition Modality or Evidence Creator has sent images, Presentation States, Spatial
Registration objects, Dose Objects, Evidence Documents or Key Image Notes to the Image
Archive, it requests that the Image Manager/Image Archive accept responsibility for them. The
objective of this transaction is to provide a formal release of storage responsibility to the
3610 Acquisition Modality or Evidence Creator, allowing it to reuse its internal resources allocated to
the study.

4.10.2 Use Case Roles

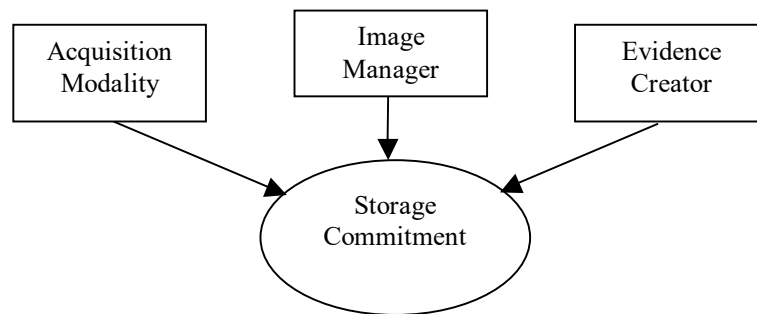

Actor: Acquisition Modality

3615 **Role:** Make requests for storage commitment to the Image Manager for DICOM objects
previously transmitted.

Actor: Evidence Creator

Role: Make requests for storage commitment to the Image Manager for the images, Presentation States, Spatial Registration objects, Dose Objects, Key Image Notes, and Evidence Documents previously transmitted.

3620 **Actor:** Image Manager.

Role: Assume responsibility for reliable storage, retrieval, and validity of images, Presentation States, Spatial Registration objects, Dose Objects, Key Image Notes, and Evidence Documents.

4.10.3 Referenced Standards

DICOM PS 3.4: Storage Commitment Push Model SOP Class.

3625 **4.10.4 Interaction Diagram**

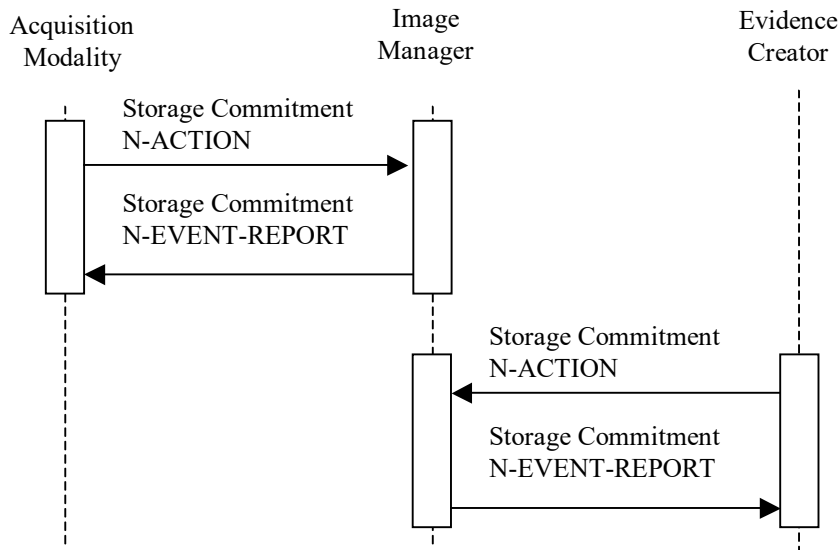

4.10.4.1 Images Committed

3630 The Storage Commitment Push Model SOP Class shall be used as reflected in the interaction diagram. The Storage Commitment Pull Model SOP Class will not be supported. Refer to the DICOM PS 3.4 for detailed descriptive semantics.

4.10.4.1.1 Trigger Events

The Acquisition Modality and Evidence Creator act as the Storage Commitment SCUs and can issue a commitment request at any time after the successful transfer of one or more SOP Instances to the Image Manager/Archive, which is the Storage Commitment SCP.

3635 **4.10.4.1.2 Message Semantics**

3640 The Acquisition Modality and Evidence Creator use the DICOM Storage Commitment SOP Class to communicate with the Image Manager. The Acquisition Modality and Evidence Creator shall convey the reference to SOP Class and Instance by using the Modality Performed Procedure Step (see Section A.1) instead of using the Referenced Performed Procedure Step Sequence (0008,1111). The Storage Commitment AE Title used by the Image Manager may or may not be the same AE Title as the one used for the Images Stored (C-STORE) service. The Acquisition Modality and Evidence Creator shall support this flexibility with respect to the AE Title. The N-EVENT-REPORT sent by the Image Manager to communicate its storage commitment may or may not occur on the same association as the N-ACTION.

3645 An Acquisition Modality and Evidence Creator may receive the Retrieve AE Title in a Storage Commitment Message (N-EVENT REPORT). However, this N-EVENT REPORT may happen well after the Modality Performed Procedure Step N-SET (Complete) was performed. For this

3650 reason, the IHE Radiology Technical Framework does not require that the Acquisition Modality and Evidence Creator send the Retrieve AE Title Attribute (0008,0054) in the Modality and Creator Performed Procedure Step N-SET (See Sections 4.7 and 4.21).

Under normal circumstances, in the event that the Image Manager cannot service the storage commitment request, which can be determined by the "Failure Reason Attribute," the Acquisition Modality and Evidence Creator shall not delete nor modify the respective SOP instance(s).

3655 **4.10.4.1.3 Expected Actions**

3660 The Image Manager in coordination with the Image Archive accepts responsibility for the safe storage of the transferred DICOM instances. (The form of the cooperation is beyond the scope of the IHE Radiology Technical Framework.) Ownership of data transfers from the Acquisition Modality to the Image Manager. The Acquisition Modality is then free to manage its own internal resources accordingly.

4.11 Image Availability Query [RAD-11]

3665 This section corresponds to Transaction RAD-11 of the IHE Technical Framework. Transaction RAD-11 is used by the Department System Scheduler, Report Manager and Image Manager Actors.

4.11.1 Scope

3670 The purpose of this transaction is for the Department System Scheduler/Order Filler and Report Manager to determine whether SOP instances associated with a particular performed procedure step have been stored and are available for use in subsequent workflow steps as well as the storage location for retrieval of these SOP instances. The Image Manager is assumed to possess image availability information. The following examples show possible uses of the Image Availability Query:

- 3675 • The Department System Scheduler/Order Filler queries the Image Manager after receiving notification, that images have been acquired (by MPPS N-SET message with PPS status of “COMPLETED” – see transaction RAD-7) until it receives a list of all images listed in the PPS.
- The Department System Scheduler/Order Filler needs to verify the availability of prior images pre-fetched according to workflow rules. In this case the availability of a single image may have to be verified.
- 3680 • The Report Manager queries the Image Manager after receiving notification, that images have been acquired (by MPPS N-SET message with PPS status of “COMPLETED” – see transaction RAD-7) until it receives a list of all images listed in the PPS. At this time the Report Manager may schedule the appropriate task so that the reporting process can commence.
- 3685 • The Report Manager needs to verify the availability of prior images pre-fetched according to workflow rules. In this case the availability of a single image may have to be verified.

3690 Image availability is determined by the fact that the Image Instance UID in question is returned in response to the query. However, for the purposes of workflow management, image availability is generally qualified with additional parameters, such as:

Storage Location describes a system or system component (for instance, an Image Archive) that can be identified as a holder of images at a particular period in time.

3695 *Access Time* is a period of time that is required for images to be moved from a storage location to be ready for distribution; i.e., this does not take into consideration the outbound network transfer time or the performance of the receiver application to display the images. The exact access time is difficult to determine and is highly implementation-dependent. Nevertheless, it is possible to approximate access time by using a degree or level of image availability.

4.11.2 Use Case Roles

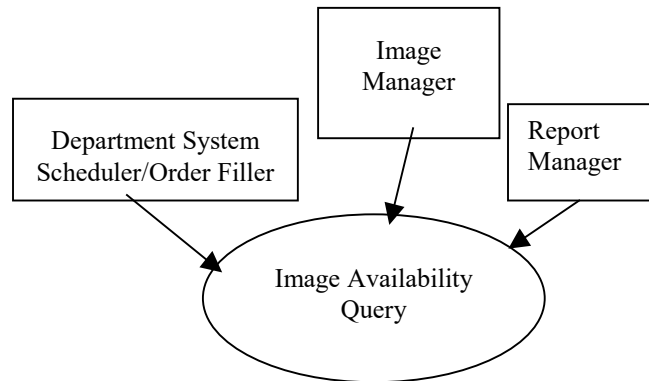

3700

Actor: Department System Scheduler/Order Filler

Role: Queries Image Manager to determine availability of images for use in the processes according to department workflow (for example, interpretation)

Actor: Report Manager

3705

Role: Queries Image Manager to determine availability of images for use in the processes according to department workflow (for example, interpretation)

Actor: Image Manager

Role: Supplies image availability information to Department System Scheduler/Order Filler

4.11.3 Referenced Standards

3710

DICOM PS 3.4: Query/Retrieve Service Class.

4.11.4 Interaction Diagram

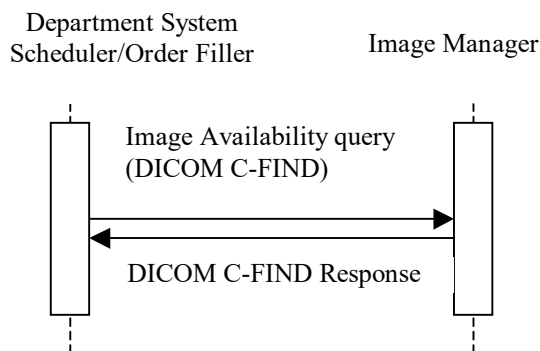

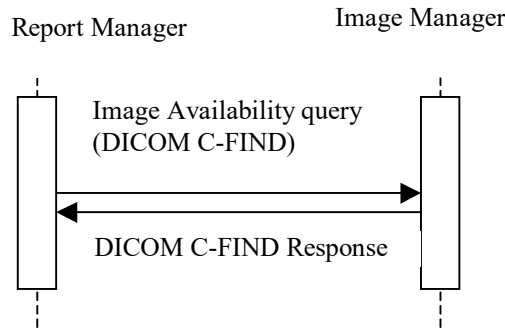

3715

4.11.4.1 Query Image Availability

4.11.4.1.1 Trigger Events

After receiving MPPS N-SET message with PPS status of “COMPLETED” or at a later time, the Department System Scheduler/Order Filler or Report Manager needs to verify image availability.

3720 4.11.4.1.2 Message Semantics

The Department System Scheduler/Order Filler or Report Manager issues a C-FIND request as specified in the DICOM Standard for the Study Root Query/Retrieve Information Model – FIND SOP Class. The Department System Scheduler/Order Filler and Report Manager must be configured with the AE information of the Image Managers to be queried. To obtain the list of images in question, the Department System Scheduler/Order Filler and Report Manager shall perform a query on the Image Level based on the specification in DICOM. The Hierarchical Search Method shall be supported. The following table highlights important attributes of the query. It is not the intent of this transaction to provide a mechanism for polling. The Department System Scheduler/Order Filler and Report Manager shall query the Image Manager with the minimal number of queries necessary. For example, if the purpose is to verify availability of all images in a series, DSS/OF shall not send queries on an image-by-image basis. In this case, a single, zero length value for the SOP Instance UID could be sent, then all matched images information will be returned.

Table 4.11-1: Images Availability Query Keys

Attribute	Tag	Query Key value
Query/Retrieve Level	(0008,0052)	IMAGE
Study Instance UID	(0020,000D)	Unique value for single-value match
Series Instance UID	(0020,000E)	Unique value for single-value match
SOP Instance UID	(0008,0018)	Single value, zero length value or list of UIDs

3735 Per the DICOM standard, Retrieve AE Title (0008,0054) shall be supported and returned by the Image Manager as part of the response.

3740 To better quantify Access Time, the optional attribute Instance Availability (0008,0056) with enumerated values of “ONLINE”, “NEARLINE” and “OFFLINE” may be used. In terms of access times and results of subsequent Retrieve (C-MOVE) request, the Image Availability values shall be interpreted as follows:

Table 4.11-2: Image Access Time

Level	Description	Access time
ONLINE	Images can be retrieved from storage location and be ready for distribution within a reasonable period of time (what time is reasonable is implementation-specific)	Typically, seconds to a few minutes
NEARLINE	Before distribution, images has to be processed at a storage location; total retrieval time is longer than “reasonable”	Typically, minutes to an hour
OFFLINE	Image cannot be distributed without human user intervention	Typically, minutes to hours to days

4.11.4.1.3 Expected Actions

3745 The Image Manager shall respond to the C-FIND as specified in the DICOM standard, including returning the SOP Instance UIDs (0008,0018) and corresponding Retrieve AE title (0008, 0054) when the match is successful.

4.12 Patient Update [RAD-12]

3750 This section corresponds to Transaction RAD-12 of the Technical Framework. Transaction RAD-12 is used by the ADT, Order Placer, Department System Scheduler, Report Manager and Image Manager Actors.

4.12.1 Scope

3755 This transaction involves changes to patient information, including demographics, patient identification, patient location/class changes, and patient merges. These changes may occur at any time for a patient record. This transaction is used for both inpatients (i.e., those who are assigned a bed at the facility) and outpatients (i.e., those who are not assigned a bed at the facility) if the patient has been previously registered.

4.12.2 Use Case Roles

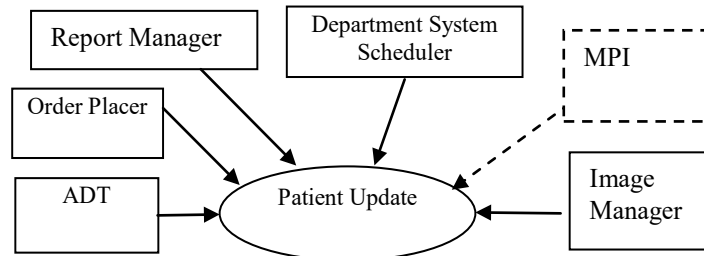

3760 **Actor:** ADT

Role: Adds and modifies patient demographic and encounter information.

Actor: Order Placer

Role: Receives patient and encounter information for use in order entry.

Actor: Department System Scheduler

3765 **Role:** Receives and updates patient and encounter information to maintain consistency with ADT and MPI systems. Shall provide the updated patient and encounter information to the Image Manager.

Actor: MPI

3770 **Role:** Receives patient and encounter information from multiple ADT systems. Maintains unique enterprise-wide identifier for a patient.

Actor: Image Manager

Role: Receives patient and encounter information for use in maintaining its database of images and other evidence documents and, possibly, for management such as auto-routing evidence objects to a specific in-patient floor.

3775 **Actor:** Report Manager

Role: Receives patient and encounter information for use in maintaining its report database.

3780 **Note:** The IHE Technical Framework currently does not support the use of a Master Patient Index, which is required for synchronization of patient information between multiple ADT systems employed by a healthcare enterprise. It is expected that the IHE initiative will include an MPI Actor in the future and that the Patient Update/Merge Transaction between the ADT and MPI will be similar to the transaction between the ADT and Order Placer and Order Filler Actors.

4.12.3 Referenced Standards

3785 HL7 v2.3.1 Chapters 2, 3

HL7 v2.5.1 Chapters 2, 3

ITI Technical Framework

4.12.4 Interaction Diagram

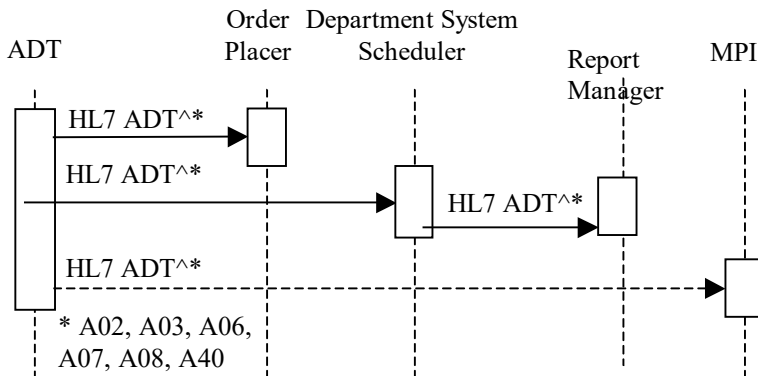
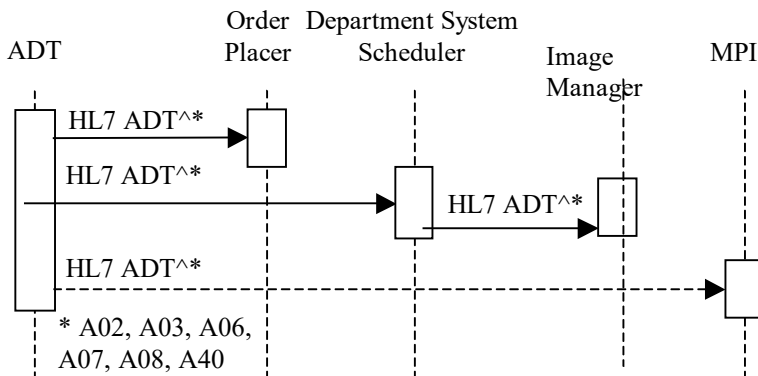

3790

4.12.4.1 Patient Management – Patient Transfer

4.12.4.1.1 Trigger Events

Changes in patient location result in the following Update Patient message:

A02 – Patient Transfer

3795 An A02 event is issued as a result of the patient changing his or her assigned physical location.

4.12.4.1.2 Message Semantics

The Update Patient transaction is an HL7 ADT message. The message shall be generated by the system that performs the update whenever an error is resolved or a change occurs in patient location.

3800 4.12.4.1.2.1 Message Semantics (HL7 v2.3.1)

The segments of the **Patient Transfer** message listed below are required, and the detailed description of messages is provided in the following subsections.

ADT A02	Patient Administration Message	Chapter in HL7 v2.3.1
MSH	Message Header	2
EVN	Event Type	3
PID	Patient Identification	3
PV1	Patient Visit	3

3805 Each message shall be acknowledged by the HL7 ACK message sent by the receiver of ADT message to its sender. See Section 2.4.3 “Acknowledgement Modes” for definition and discussion of the ACK message.

4.12.4.1.2.1.1 MSH Segment (HL7 v2.3.1)

MSH segment shall be constructed as defined in the Section 2.4.2.2 “Message Control”.

3810 Field *MSH-9 Message Type* shall have at least two components. The first component shall have a value of “ADT”; the second component shall have value of A02. The third component is optional; however, if present, it shall have a value of ADT_A02.

4.12.4.1.2.1.2 EVN Segment (HL7 v2.3.1)

See Section 4.1.4.1.2.1.2 for required and optional fields of the EVN segment.

4.12.4.1.2.1.3 PID Segment (HL7 v2.3.1)

3815 Most of the fields in PID segment are optional, except those listed in Table 4.12-1. See Section 4.1.4.1.2.1.3 for the list of all fields of the PID segment.

Table 4.12-1: IHE Profile - PID segment

SEQ	LEN	DT	OPT	TBL#	ITEM#	ELEMENT NAME
3	20	CX	R		00106	Patient Identifier List
5	48	XPN	R		00108	Patient Name
18	20	CX	C		00121	Patient Account Number

Adapted from the HL7 standard, version 2.3.1

3820 **4.12.4.1.2.1.4 PV1 Segment (HL7 v2.3.1)**

Most of the fields in PV1 segment are optional, except those listed in Table 4.12-2. See Section 4.1.4.1.2.1.4 for the list of all fields of the PV1 segment.

Table 4.12-2: IHE Profile - PV1 Segment

SEQ	LEN	DT	OPT	TBL#	ITEM#	ELEMENT NAME
2	1	IS	R	0004	00132	Patient Class
3	80	PL	C		00133	Assigned Patient Location
6	80	PL	C		00136	Prior Patient Location
10	3	IS	R	0069	00140	Hospital Service
11	80	PL	C		00141	Temporary Location
19	20	CX	C		00149	Visit Number
43	80	PL	C		00173	Prior Temporary Location
51	1	IS	C	0326	01226	Visit Indicator

Adapted from the HL7 standard, version 2.3.1

3825 At least one of the fields *PID-18 Patient Account Number* or *PV1-19 Visit Number* shall be valued. Additional requirements for the presence of value in these fields may be documented in regional or national extensions to the IHE Radiology Technical Framework (See RAD TF-4).

Field *PV1-51 Visit Indicator* shall be valued with value “V” if the field *PV1-19 Visit Number* is present. May be omitted otherwise.

3830 The new patient location shall appear either in the field *PV1-3 Assigned Patient Location* or *PV1-11 Temporary Location* (if the transfer is to a temporary location). The old patient location shall appear in the field *PV1-6 Prior Patient Location* or *PV1-43 Prior Temporary Location* (if the transfer is from a temporary location).

4.12.4.1.2.2 Message Semantics (HL7 v2.5.1 Option)

3835 The RAD-12 Patient Management-Patient Transfer message is defined in the ITI Technical Framework as follows:

- ADT^A02 Admit Patient in ITI TF-2b:3.31.7.11 Patient Transfer (ADT^A02^ADT_A02)

The segments listed below are required.

ADT A02	Patient Administration Message	Chapter in HL7 v2.5.1
MSH	Message Header	2
EVN	Event Type	3
PID	Patient Identification	3
PV1	Patient Visit	3
{ ROL }	Role	15

3840 Each message shall be acknowledged by the HL7 ACK message sent by the receiver of ADT message to its sender. See Section 2.4 for definition and discussion of the ACK message.

4.12.4.1.2.2.1 MSH Segment (HL7 v2.5.1 Option)

3845 The MSH segment shall be constructed as defined in ITI TF-2b:3.30.5.1 MSH – Header Segment. Additional specifications for actors complying with the IHE Radiology Technical Framework are defined in Section 2.4.

Field *MSH-9-Message Type* shall have three components. The first component shall have a value of ADT; the second component shall have a value of A02; the third component shall have a value of ADT_A02.

4.12.4.1.2.2.2 EVN Segment (HL7 v2.5.1 Option)

3850 The EVN segment shall be constructed as defined in ITI TF-2b:3.30.5.2 EVN – Event Type Segment.

4.12.4.1.2.2.3 PID Segment (HL7 v2.5.1 Option)

Most of the fields in the PID segment are optional, except those listed in Table 4.12-3. See ITI TF-2b:3.30.5.3 for a list of all of the fields of the PID segment.

3855 **Table 4.12-3: IHE Profile - PID segment**

SEQ	LEN	DT	OPT	TBL#	ITEM#	ELEMENT NAME
3	250	CX	R		00106	Patient Identifier List
5	250	XPN	R		00108	Patient Name
18	250	CX	C		00121	Patient Account Number

Adapted from the HL7 standard, version 2.5.1

4.12.4.1.2.2.4 PV1 Segment (HL7 v2.5.1 Option)

3860 Most of the fields in the PV1 segment are optional, except those listed in Table 4.12-4. See ITI TF-2b:3.30.5.4 for a list of all of the fields of the PV1 segment.

Table 4.12-4: IHE Profile - PV1 Segment

SEQ	LEN	DT	OPT	TBL#	ITEM#	ELEMENT NAME
2	1	IS	R	0004	00132	Patient Class
3	80	PL	C		00133	Assigned Patient Location
6	80	PL	C		00136	Prior Patient Location
10	3	IS	R	0069	00140	Hospital Service
11	80	PL	C		00141	Temporary Location
19	250	CX	C		00149	Visit Number
43	80	PL	C		00173	Prior Temporary Location
51	1	IS	C	0326	01226	Visit Indicator

Adapted from the HL7 standard, version 2.5.1

The PV1 segment shall be followed, for each of the consulting doctor(s), attending doctor, admitting doctor, and referring doctor, by a ROL segment.

3865 Field *PV1-9-Consulting Doctor* shall not be present. The consulting doctor(s) are entirely described in the ROL segments.

At least one of the fields *PID-18-Patient Account Number* or *PV1-19-Visit Number* shall be valued. Additional requirements for the presence of value in these fields may be documented in regional or national extensions to the IHE Radiology Technical Framework (See RAD TF-4).

3870 Field *PV1-51-Visit Indicator* shall be valued with value “V” if the field *PV1-19 Visit Number* is value. It may be omitted otherwise.

The new patient location shall appear either in the field *PV1-3-Assigned Patient Location* or *PV1-11-Temporary Location* (if the transfer is to a temporary location). The old patient location shall appear in the field *PV1-6-Prior Patient Location* or *PV1-43-Prior Temporary Location* (if the transfer is from a temporary location).

3875

4.12.4.1.2.2.5 ROL Segment (HL7 v2.5.1 Option)

One ROL segment shall be included for each attending doctor, admitting doctor, referring doctor and consulting doctor, if any. Note that some Provider Role codes in the ROL Segment use the word "Provider" rather than "Doctor".

3880 The ROL Segment shall be constructed as defined in ITI TF-2b:3.30.5.6 ROL- Role Segment.

4.12.4.1.3 Expected Actions

It is expected that after receiving Patient Transfer message (A02) the receiving system will change its records about patient location.

3885 It is the responsibility of the Image Manager and the Report Manager to ensure that the patient information (including the patient location) has been updated in the diagnostic reports and any relevant objects they manage when they are retrieved.

4.12.4.2 Patient Management – Update Patient Class

4.12.4.2.1 Trigger Events

3890 Changes “in patient” class (that is from an inpatient status to outpatient, from an outpatient status to inpatient, from “admitted” or “non-admitted” status to discharged) result in one of the following Update Patient messages:

- A03 – Patient Discharge
- A06 – Change an Outpatient to an Inpatient
- A07 – Change an Inpatient to an Outpatient

3895 An A03 event signals the end of a patient’s stay in a healthcare facility. For in-patient, it signals that the patient’s status has changed to “discharged” and the patient is no longer in the facility. For outpatient, it signals the end of current visit of a patient to the facility. An A06 event is sent when a patient who was present for a non-admitted visit is being admitted. This event changes a patient’s status from non-admitted to “admitted”. An A07 event is sent when a patient who was admitted changes his/her status to “no longer admitted” but is still being seen for this episode of care. This event changes a patient from an “admitted” to a “non-admitted” status.

3900

4.12.4.2.2 Message Semantics

4.12.4.2.2.1 Message Semantics (HL7 v2.3.1)

3905 The Update Patient transaction is an HL7 ADT message. The message shall be generated by the system that performs the update whenever patient class changes.

The segments of the **Update Patient Class** messages listed below are required, and the detailed description of messages is provided in Sections 4.12.4.1.2.1.1 through 4.12.4.1.2.1.3.

ADT A03/A06/A07	Patient Administration Message	Chapter in HL7 v2.3.1
MSH	Message Header	2
EVN	Event Type	3
PID	Patient Identification	3
PV1	Patient Visit	3

3910 Each message shall be acknowledged by the HL7 ACK message sent by the receiver of ADT message to its sender. See Section 2.4.3 “Acknowledgement Modes” for definition and discussion of the ACK message.

4.12.4.2.2.1.1 MSH Segment (HL7 v2.3.1)

MSH segment shall be constructed as defined in the Section 2.4.2.2 “Message Control”.

3915 Field *MSH-9 Message Type* shall have at least two components. The first component shall have a value of “ADT”; the second component shall have value of A03, A06 or A07, as appropriate.

The third component is optional; however, if present, it shall have a value of ADT_A03 (for A03 message) or ADT_A06 (for A06 and A07 messages).

4.12.4.2.2.1.2 EVN Segment (HL7 v2.3.1)

See Section 4.1.4.1.2.1.2 for required and optional fields of the EVN segment.

3920 **4.12.4.2.2.1.3 PID Segment (HL7 v2.3.1)**

Most of the fields in PID segment are optional, except those listed in Table 4.12-5. See Section 4.1.4.1.2.1.3 for the list of all fields of the PID segment.

Table 4.12-5: IHE Profile - PID segment

SEQ	LEN	DT	OPT	TBL#	ITEM#	ELEMENT NAME
3	20	CX	R		00106	Patient Identifier List
5	48	XP	R		00108	Patient Name
18	20	CX	C		00121	Patient Account Number

Adapted from the HL7 standard, version 2.3.1

3925 **4.12.4.2.2.1.4 PV1 Segment (HL7 v2.3.1)**

Most of the fields in PV1 segment are optional, except those listed in Table 4.12-6. See Section 4.1.4.1.2.1.4 for the list of all fields of the PV1 segment.

Table 4.12-6: IHE Profile - PV1 Segment

SEQ	LEN	DT	OPT	TBL#	ITEM#	ELEMENT NAME
2	1	IS	R	0004	00132	Patient Class
3	80	PL	R		00133	Assigned Patient Location
6	80	PL	C		00136	Prior Patient Location
7	60	XCN	C	0010	00137	Attending Doctor
8	60	XCN	C	0010	00138	Referring Doctor
9	60	XCN	R2	0010	00139	Consulting Doctor
17	60	XCN	C	0010	00147	Admitting Doctor
19	20	CX	C		00149	Visit Number
43	80	PL	C		00173	Prior Temporary Location
51	1	IS	C	0326	01226	Visit Indicator

Adapted from the HL7 standard, version 2.3.1

3930 At least one of the fields *PID-18 Patient Account Number* or *PV1-19 Visit Number* shall be valued. Additional requirements for the presence of value in these fields may be documented in regional or national extensions to the IHE Radiology Technical Framework (See RAD TF-4).

Field *PV1-51 Visit Indicator* shall be valued with value “V” if the field *PV1-19 Visit Number* is present. May be omitted otherwise.

3935 For “Discharge Patient” (A03) message:

- The field *PV1-3 Assigned Patient Location* shall contain the patient’s location prior to discharge.
- The field *PV1-45 Discharge Date/Time* does not have to be present in A03. If PV1-45 is not present then the timestamp in the EVN segment (*EVN-2 Recorded Date/Time*) signifies date and time of discharge.

3940

For “Change an Outpatient to an Inpatient” (A06) message:

- The new patient class shall appear in PV1-2-patient class.
- The new patient location shall appear in PV1-3-assigned patient location.
- The old patient location (if relevant) shall appear in PV1-6-prior patient location.
- The current active account number shall appear in PID-18-patient account number.
- The Attending Doctor in PV1-7, the Referring Doctor in PV1-8, and the Consulting Doctor in PV1-9, may be different, if there are changes to those values.

3945

For “Change an Inpatient to an Outpatient” (A07) message:

- The new patient class shall appear in PV1-2-patient class.
- The old patient location shall appear in PV1-6-prior patient location or *PV1-43 Prior Temporary Location*.
- The current active account number shall appear in field PID-18-patient account number.
- The Attending Doctor in PV1-7, the Referring Doctor in PV1-8, and the Consulting Doctor in PV1-9, may be different, if there are changes to those values.

3950

3955 A06 and A07 messages shall be used exclusively to send fields pertinent to the change in patient class between inpatient and outpatient.

Modification of any patient demographic information or non patient-class visit information must be done by in addition sending an Update Patient Information (A08) message.

4.12.4.2.2.2 Message Semantics (HL7 v2.5.1 Option)

3960 The messages that are used to implement the RAD-12 Patient Management – Update Patient Class message are described in the following ITI Sections:

- ITI TF-2b:3.31.7.4 Discharge/End Visit (ADT^A03^ADT_A03)
- ITI TF-2b:3.31.7.9 Change an Outpatient to an Inpatient (ADT^A06^ADT_A06)
- ITI TF-2b:3.31.7.10 Change an Inpatient to an Outpatient (ADT^A07^ADT_A06)

3965 The segments of the Update Patient Class message listed below are required. The detailed description of each segment is provided in the following subsections, including references to the

corresponding ITI section, followed by additional requirements to comply with the IHE Radiology Technical Framework.

3970

ADT A03/A06/A07	Patient Administration Message	Chapter in HL7 v2.5.1
MSH	Message Header	2
EVN	Event Type	3
PID	Patient Identification	3
PV1	Patient Visit	3
{ ROL }	Role	15

Each message shall be acknowledged by the HL7 ACK message sent by the receiver of ADT message to its sender. See Section 2.4.4.3 “Acknowledgement Modes” for definition and discussion of the ACK message.

4.12.4.2.2.2.1 MSH Segment (HL7 v2.5.1 Option)

3975

The MSH segment shall be constructed as defined in ITI TF-2b:3.30.5.1 MSH – Header Segment. Additional specifications for actors conforming to the IHE Radiology Technical Framework are defined in Section 2.4.

Field *MSH-9-Message Type* shall have three components. The first component shall have a value of ADT; the second component shall have a value of A03, A06, or A07, as appropriate; the third component shall have a value of ADT_A03 (for A03 message) or ADT_A06 (for A06 and A07 messages).

3980

4.12.4.2.2.2.2 EVN Segment (HL7 v2.5.1 Option)

The EVN segment shall be constructed as defined in ITI TF-2b:3.30.5.2 EVN – Event Type Segment.

3985

4.12.4.2.2.2.3 PID Segment (HL7 v2.5.1 Option)

Most of the fields in the PID segment are optional, except those listed in Table 4.12-7. See ITI TF-2b:3.30.5.3 for a list of all of the fields of the PID segment.

Table 4.12-7: IHE Profile - PID segment

SEQ	LEN	DT	OPT	TBL#	ITEM#	ELEMENT NAME
3	250	CX	R		00106	Patient Identifier List
5	250	XPN	R		00108	Patient Name
18	250	CX	C		00121	Patient Account Number

Adapted from the HL7 standard, version 2.5.1

3990 **4.12.4.2.2.4 PV1 Segment (HL7 v2.5.1 Option)**

Most of the fields in the PV1 segment are optional, except those listed in Table 4.12-8. See ITI TF-2b:3.30.5.4 for a list of all of the fields of the PV1 segment.

Table 4.12-8: IHE Profile - PV1 Segment

SEQ	LEN	DT	OPT	TBL#	ITEM#	ELEMENT NAME
2	1	IS	R	0004	00132	Patient Class
3	80	PL	R		00133	Assigned Patient Location
6	80	PL	C		00136	Prior Patient Location
7	250	XCN	C	0010	00137	Attending Doctor
8	250	XCN	C	0010	00138	Referring Doctor
9	250	XCN	X	0010	00139	Consulting Doctor
17	250	XCN	C	0010	00147	Admitting Doctor
19	250	CX	C		00149	Visit Number
43	80	PL	C		00173	Prior Temporary Location
51	1	IS	C	0326	01226	Visit Indicator

Adapted from the HL7 standard, version 2.5.1

3995 At least one of the fields *PID-18-Patient Account Number* or *PV1-19-Visit Number* shall be valued. Additional requirements for the presence of value in these fields may be documented in regional or national extensions to the IHE Radiology Technical Framework (See RAD TF-4).

Field *PV1-51-Visit Indicator* shall be valued with value “V” if field *PV1-19-Visit Number* is valued. It may be omitted otherwise.

4000 For the “Discharge Patient” (A03) message:

- Field *PV1-3-Assigned Patient Location* shall contain the patient’s location prior to discharge.
- Field *PV1-45-Discharge Date/Time* does not have to be present in A03. If PV1-45 is not present then the timestamp in the EVN segment (*EVN-2-Recorded Date/Time*) signifies the date and time of discharge.

4005

For “Change an Outpatient to an Inpatient” (A06) message:

- The new patient class shall appear in *PV1-2-patient class*.
- The new patient location shall appear in *PV1-3-assigned patient location*.
- The old patient location (if relevant) shall appear in *PV1-6-prior patient location*.
- The current active account number shall appear in *PID-18-patient account number*.
- *PV1-7-Attending Doctor* and *PV1-8-Referring Doctor* may be different, if there are changes to those values.

4010

- The Consulting Doctor, if changed, will be communicated in a ROL segment immediately following the PV1 segment.

4015 For “Change an Inpatient to an Outpatient” (A07) message:

- The new patient class shall appear in *PV1-2-patient class*.
- The old patient location shall appear in PV1-6-prior patient location or PV1-43 Prior Temporary Location.
- The current active account number shall appear in field *PID-18-patient account number*.

4020 • *PV1-7-Attending Doctor* and *PV1-8-Referring Doctor* may be different, if there are changes to those values.

- The Consulting Doctor, if changed, will be communicated in a ROL segment immediately following the PV1 segment.

4025 The PV1 segment shall be followed, for each of the attending doctor, admitting doctor, and referring doctor, by a ROL segment.

A06 and A07 messages shall be used exclusively to send fields pertinent to the change in patient class between inpatient and outpatient.

4030 Modification of any patient demographic information or non-patient-class visit information must be done by sending a Patient Information Update message (see Section 4.12.4.3) in addition to the Update Patient Class message.

4.12.4.2.2.5 ROL Segment (HL7 v2.5.1 Option)

One ROL segment shall be included for each attending doctor, admitting doctor, referring doctor and consulting doctor that is changed. Note that some Provider Role codes in the ROL Segment use the word "Provider" rather than "Doctor".

4035 The ROL Segment shall be constructed as defined in ITI TF-2b:3.30.5.6 ROL- Role Segment.

4.12.4.2.3 Expected Actions

It is expected that after receiving Patient Class Change message (A03/A06/A07) it is expected that the receiving system will change its local patient visit information.

4040 It is the responsibility of the Image Manager and the Report Manager to ensure that the patient information (including the patient location) has been updated in the diagnostic reports and any relevant objects they manage when they are retrieved.

4.12.4.3 Patient Management – Patient Information Update

4.12.4.3.1 Trigger Events

4045 Changes to patient demographics and account information (e.g., change in patient name, patient address, etc.) shall trigger the following Update Patient message:

- A08 – Update Patient Information

4.12.4.3.2 Message Semantics

4050 The Update Patient transaction is an HL7 ADT message. The message shall be generated by the system that performs the update whenever an error is resolved or a change occurs in patient demographics.

4055 All of the required (R and R2) information for a patient record shall be re-sent in an A08 message. Any information received as NULL (i.e., transmitted as two double quote marks “”) in the A08 message shall be removed from the receiving system's database for that patient record. If no value is sent (i.e., omitted) in the A08 message, the old value shall remain unchanged in the receiving system's database for that patient record.

An A08 message is the only method that may be used to update patient demographic and visit information. However Patient ID cannot be updated with an A08 message. An A40 message shall be used for this purpose (see Section 4.12.4.4.2.1.5 for HL7 v2.3.1 or Section 4.12.4.4.2.2.5 for HL7 v2.5.1 Option).

4060 4.12.4.3.2.1 Message Semantics (HL7 v2.3.1)

The segments of the **Update Patient Information** message listed below are required, and the detailed description of the message is provided in Section 4.12.4.1.2.1.4. The allergy segment AL1 shall be present if allergy information is added/updated. OBX segment(s) shall be present if patient weight and/or height is updated.

4065

ADT A08	Patient Administration Message	Chapter in HL7 v2.3.1
MSH	Message Header	2
EVN	Event Type	3
PID	Patient Identification	3
PV1	Patient Visit	3
[{OBX}]	Observation/results	7
[{AL1}]	Allergy	3

Each message shall be acknowledged by the HL7 ACK message sent by the receiver of ADT message to its sender. See Section 2.4.3 “Acknowledgement Modes” for definition and discussion of the ACK message.

4.12.4.3.2.1.1 MSH Segment (HL7 v2.3.1)

4070 MSH segment shall be constructed as defined in the Section 2.4.2.2 “Message Control”.

Field *MSH-9 Message Type* shall have at least two components. The first component shall have a value of “ADT”; the second component shall have value of A08. The third component is optional; however, if present, it shall have a value of ADT_A08.

4.12.4.3.2.1.2 EVN Segment (HL7 v2.3.1)

4075 See Section 4.1.4.1.2.1.2 for required and optional fields of the EVN segment.

4.12.4.3.2.1.3 PID Segment (HL7 v2.3.1)

The required fields of the PID segment are listed in Table 4.12-9. All other fields are conditional and shall be present if the value of the field has been changed by the ADT. See Section 4.1.4.1.2.1.3 for the list of all fields of the PID segment.

4080 Note that certain visit information, such as patient location and class may not be changed with this message. In these cases **Patient Transfer** and **Change Patient Class** messages shall be used.

Table 4.12-9: IHE Profile - PID segment

SEQ	LEN	DT	OPT	TBL#	ITEM#	ELEMENT NAME
3	20	CX	R		00106	Patient Identifier List
5	48	XP	R		00108	Patient Name
18	20	CX	C		00121	Patient Account Number

Adapted from the HL7 standard, version 2.3.1

4085 **4.12.4.3.2.1.4 PV1 Segment (HL7 v2.3.1)**

Most of the fields in PV1 segment are optional, except those listed in Table 4.12-10. See Section 4.1.4.1.2.1.4 for the list of all fields of the PV1 segment.

Table 4.12-10: IHE Profile - PV1 Segment

SEQ	LEN	DT	OPT	TBL#	ITEM#	ELEMENT NAME
2	1	IS	R	0004	00132	Patient Class
19	20	CX	C		00149	Visit Number
51	1	IS	C	0326	01226	Visit Indicator

Adapted from the HL7 standard, version 2.3.1

4090 At least one of the fields *PID-18 Patient Account Number* or *PV1-19 Visit Number* shall be valued. Additional requirements for the presence of value in these fields may be documented in regional or national extensions to the IHE Radiology Technical Framework (See RAD TF- 4). Field *PV1-51 Visit Indicator* shall be valued with value “V” if the field *PV1-19 Visit Number* is present. May be omitted otherwise.

4095 **4.12.4.3.2.1.5 AL1 Segment (HL7 v2.3.1)**

See Section 4.1.4.1.2.1.5 for required and optional fields of the AL1 segment.

4.12.4.3.2.1.6 OBX Segment (HL7 v2.3.1)

See Section 4.1.4.1.2.1.6 for required and optional fields of the OBX segment.

4.12.4.3.2.2 Message Semantics (HL7 v2.5.1 Option)

4100 The RAD-12 Patient Management-Patient Information Update is defined in the ITI Technical Framework as follows:

- ITI TF-2b:3.31.7.6 Patient Update Information (ADT^A08^ADT_A01)

4105 The required segments of the **Patient Update Information** message are listed below. The detailed description of each segment is provided in the following subsections, including references to the corresponding ITI section, followed by additional requirements to comply with the IHE Radiology Technical Framework.

ADT A08	Patient Administration Message	Chapter in HL7 v2.5.1
MSH	Message Header	2
EVN	Event Type	3
PID	Patient Identification	3
PV1	Patient Visit	3
ROL	Role	15
[{OBX}]	Observation/results	7
[{AL1}]	Allergy	3

4110 The allergy segment AL1 shall be present if allergy information is added/updated. OBX segment(s) shall be present if patient weight and/or height is updated.

4.12.4.3.2.2.1 MSH Segment (HL7 v2.5.1 Option)

The MSH segment shall be constructed as defined in ITI TF-2b:3.30.5.1 MSH – Header Segment. Additional specifications for actors complying with the IHE Radiology Technical Framework are defined in Section 2.4.2.2 “Message Control”.

4115 Field *MSH-9-Message Type* shall have three components. The first component shall have a value of ADT; the second component shall have a value of A08; the third component shall have a value of ADT_A08.

4.12.4.3.2.2.2 EVN Segment (HL7 v2.5.1 Option)

4120 The EVN segment shall be constructed as defined in ITI TF-2b:3.30.5.2 EVN – Event Type Segment.

4.12.4.3.2.2.3 PID Segment (HL7 v2.5.1 Option)

Most of the fields in the PID segment are optional, except those listed in Table 4.12-11. See ITI TF-2b:3.30.5.3 for a list of all of the fields of the PID segment.

Table 4.12-11: IHE Profile - PID segment

SEQ	LEN	DT	OPT	TBL#	ITEM#	ELEMENT NAME
3	250	CX	R		00106	Patient Identifier List
5	250	XPN	R		00108	Patient Name
18	250	CX	C		00121	Patient Account Number

4125

Adapted from the HL7 standard, version 2.5.1

Note that certain visit information, such as patient location and class, may not be changed with this message. In these cases Patient Transfer and Change Patient Class messages shall be used.

4.12.4.3.2.2.4 PV1 Segment (HL7 v2.5.1 Option)

4130

All of the fields in the PV1 segment are optional, except those listed in Table 4.12-12. See Section 4.1.4.1.2.2.4 for a full discussion of the PV1 segment.

Table 4.12-12: IHE Profile - PV1 Segment

SEQ	LEN	DT	OPT	TBL#	ITEM#	ELEMENT NAME
2	1	IS	R	0004	00132	Patient Class
19	250	CX	C		00149	Visit Number
51	1	IS	C	0326	01226	Visit Indicator

Adapted from the HL7 standard, version 2.5.1

4135

At least one of the fields *PID-18-Patient Account Number* or *PVI-19-Visit Number* shall be valued. Additional requirements for the presence of value in these fields may be documented in regional or national extensions to the IHE Radiology Technical Framework (See RAD TF-4). It is required if it has been present in the registration message A01, A04 or A05 that is being cancelled by this message.

Field *PVI-51-Visit Indicator* shall be valued with value “V” if the field *PVI-19-Visit Number* is valued. It may be omitted otherwise.

4140

4.12.4.3.2.2.5 OBX Segment (HL7 v2.5.1 Option)

See Section 4.1.4.1.2.2.6 for required and optional fields of the OBX segment.

4.12.4.3.2.2.6 AL1 Segment (HL7 v2.5.1 Option)

See Section 4.1.4.1.2.2.7 for required and optional fields of the AL1 segment.

4.12.4.3.3 Expected Actions

4145

It is expected that after receiving Patient Information Update message (A08) the receiving system will update its local patient demographic, visit, allergy, and/or insurance information. Any information received as null in the new A08 message shall be removed locally.

It is the responsibility of the Image Manager and the Report Manager to ensure that the patient information has been updated in the diagnostic reports and evidence objects (e.g., images, Key

4150 Image Notes, Grayscale Softcopy Presentation States, Evidence Documents, etc.) they manage when they are retrieved from.

4.12.4.4 Patient Management – Patient Merge

4.12.4.4.1 Trigger Events

4155 When two patient records are found to identify the same patient and are merged, the following message shall be triggered:

- A40 – Merge Patient – Internal ID

An A40 message indicates that a merge has been done at the internal identifier level. That is, PID-3 Patient ID identifier has been merged with MRG-1 Patient ID. This message is initiated by the system that performs the merge.

4160 4.12.4.4.2 Message Semantics

4.12.4.4.2.1 Message Semantics (HL7 v2.3.1)

The Update Patient transaction is an HL7 ADT message. The message shall be generated by the system that performs the update whenever Patient ID changes or two records are found to reference the same person.

4165 The segments of the **Merge Patient** message listed below are required, and the detailed description of the message is provided in Section 4.12.4.1.2.1.5. The PV1 segment is optional.

ADT A40	Patient Administration Message	Chapter in HL7 v2.3.1
MSH	Message Header	2
EVN	Event Type	3
PID	Patient Identification	3
MRG	Merge Information	3
[PV1]	Patient Visit	3

4170 Each message shall be acknowledged by the HL7 ACK message sent by the receiver of ADT message to its sender. See Section 2.4.3 “Acknowledgement Modes” for definition and discussion of the ACK message.

4.12.4.4.2.1.1 MSH Segment (HL7 v2.3.1)

MSH segment shall be constructed as defined in the Section 2.4.2.2 “Message Control”.

4175 Field *MSH-9 Message Type* shall have at least two components. The first component shall have a value of “ADT”; the second component shall have value of A40. The third component is optional; however, if present, it shall have a value of ADT_A39.

4.12.4.4.2.1.2 EVN Segment (HL7 v2.3.1)

See Section 4.1.4.1.2.1.2 for required and optional fields of the EVN segment.

4.12.4.4.2.1.3 PID Segment (HL7 v2.3.1)

4180

Most of the fields in PID segment are optional, except those listed in Table 4.12-13. See Section 4.1.4.1.2.1.3 for the list of all fields of the PID segment.

Table 4.12-13: IHE Profile - PID segment

SEQ	LEN	DT	OPT	TBL#	ITEM#	ELEMENT NAME
3	20	CX	R		00106	Patient Identifier List
5	48	XPN	R		00108	Patient Name

Adapted from the HL7 standard, version 2.3.1

4.12.4.4.2.1.4 PV1 Segment (HL7 v2.3.1)

4185

Most of the fields in PV1 segment are optional, except those listed in Table 4.12-14. See Section 4.1.4.1.2.1.4 for the list of all fields of the PV1 segment.

Table 4.12-14: IHE Profile - PV1 Segment

SEQ	LEN	DT	OPT	TBL#	ITEM#	ELEMENT NAME
2	1	IS	R	0004	00132	Patient Class
11	80	PL	O		00141	Temporary Location

Adapted from the HL7 standard, version 2.3.1

4.12.4.4.2.1.5 MRG Segment (HL7 v2.3.1)

4190

The PID segment contains the dominant patient information, including Patient ID (and Issuer of Patient ID). The MRG segment identifies the “old” or secondary patient records to be de-referenced. HL7 does not require that the 'old' record be deleted; it does require that the "incorrect" identifier not be referenced in future transactions following the merge.

Table 4.12-15: IHE Profile - MRG segment

SEQ	LEN	DT	OPT	TBL#	ITEM#	ELEMENT NAME
1	20	CX	R		00211	Prior Patient Identifier List
2	20	CX	O		00212	Prior Alternate Patient ID
3	20	CX	O		00213	Prior Patient Account Number
4	20	CX	R2		00214	Prior Patient ID
5	20	CX	O		01279	Prior Visit Number
6	20	CX	O		01280	Prior Alternate Visit ID
7	48	XPN	R2		01281	Prior Patient Name

Adapted from the HL7 Standard, version 2.3.1

4195 A separate merge message shall be sent for each patient record to be merged. For example, if Patients A, B, and C are all to be merged into Patient B, two MRG messages would be sent. In the first MRG message patient B would be identified in the PID segment and Patient A would be identified in the MRG segment. In the second MRG message, patient B would be identified in the PID segment, and Patient C would be identified in the MRG segment. The visits and accounts of patients A and C will now belong to patient B’s record along with B’s original visits and accounts.

Modification of any patient demographic information shall be done by sending a separate Update Patient Information (A08) message for the current Patient ID. An A40 message is the only method that may be used to update a Patient ID.

4205 A new Patient shall be created in the Image Manager and the Report Manager using the demographics contained in the Patient Merge (A40) message when the prior Patient to be merged does not exist on the Image Manager. This shall be followed by a Patient Update (A08) Message to update any of the demographics missing in the Patient Merge (A40) message.

4.12.4.4.2.2 Message Semantics (HL7 v2.5.1 Option)

4210 The RAD-12 Patient Merge message is defined in the ITI Technical Framework as follows:

- ITI TF-2b:3.31.7.31 Merge Two Patients (ADT^A40^ADT_A39)

4.12.4.4.2.2.1 MSH Segment (HL7 v2.5.1 Option)

4215 The MSH segment shall be constructed as defined in ITI TF-2b:3.30.5.1 MSH – Header Segment. Additional specifications for actors complying with the IHE Radiology Technical Framework are defined in Section 2.4.

Field *MSH-9-Message Type* shall have three components. The first component shall have a value of ADT; the second component shall have a value of A40; the third component shall have a value of ADT_A39.

4.12.4.4.2.2.2 EVN Segment (HL7 v2.5.1 Option)

4220 The EVN segment shall be constructed as defined in ITI TF-2b:3.30.5.2 EVN – Event Type Segment.

4.12.4.4.2.2.3 PID Segment (HL7 v2.5.1 Option)

Most of the fields in the PID segment are optional, except those listed in Table 4.12-16. See ITI TF-2b:3.30.5.3 for a list of all of the fields of the PID segment.

4225

Table 4.12-16: IHE Profile - PID segment

SEQ	LEN	DT	OPT	TBL#	ITEM#	ELEMENT NAME
3	250	CX	R		00106	Patient Identifier List
5	250	XP	R		00108	Patient Name

Adapted from the HL7 standard, version 2.5.1

4.12.4.4.2.2.4 PV1 Segment (HL7 v2.5.1 Option)

Most of the fields in the PV1 segment are optional, except those listed in Table 4.12-17. See ITI TF-2b:3.30.5.4 for a list of all of the fields of the PV1 segment.

4230

Table 4.12-17: IHE Profile - PV1 Segment

SEQ	LEN	DT	OPT	TBL#	ITEM#	ELEMENT NAME
2	1	IS	R	0004	00132	Patient Class
11	80	PL	O		00141	Temporary Location

Adapted from the HL7 standard, version 2.5.1

4.12.4.4.2.2.5 MRG Segment (HL7 v2.5.1 Option)

4235

The PID segment contains the dominant patient information, including Patient ID (and Issuer of Patient ID). The MRG segment identifies the “old” or secondary patient records to be de-referenced. HL7 does not require that the 'old' record be deleted; it does require that the "incorrect" identifier not be referenced in future messages following the merge.

Table 4.12-18: IHE Profile - MRG segment (HL7 v2.5.1 Option)

SEQ	LEN	DT	OPT	TBL#	ITEM#	ELEMENT NAME
1	250	CX	R		00211	Prior Patient Identifier List
2	250	CX	O		00212	Prior Alternate Patient ID
3	250	CX	O		00213	Prior Patient Account Number
4	250	CX	R2		00214	Prior Patient ID
5	250	CX	O		01279	Prior Visit Number
6	250	CX	O		01280	Prior Alternate Visit ID
7	250	XPN	R2		01281	Prior Patient Name

Adapted from the HL7 Standard, version 2.5.1

4240

A separate merge message shall be sent for each patient record to be merged. For example, if Patients A, B, and C are all to be merged into Patient B, two MRG messages would be sent. In the first MRG message patient B would be identified in the PID segment and Patient A would be identified in the MRG segment. In the second MRG message, patient B would be identified in the PID segment, and Patient C would be identified in the MRG segment. The visits and accounts of patients A and C will now belong to patient B’s record along with B’s original visits and accounts.

4245

Modification of any patient demographic information shall be done by sending a Patient Update Information (ADT^A08^ADT_A01) message for the current Patient ID. An A40 message is the only method that may be used to update a Patient ID.

4250

A new Patient shall be created in the Image Manager and the Report Manager using the demographics contained in the Patient Merge (A40) message when the prior Patient to be merged

does not exist on the Image Manager. This shall be followed by a Patient Update Information (ADT^A08^ADT_A01) message to update any of the demographics missing in the Patient Merge (A40) message.

4255 **4.12.4.4.3 Expected Actions**

It is expected that after receiving a Patient Merge message (A40) the receiving system will perform updates to reflect the fact that two patient records have been merged into a single record. If the correct target patient was not known to the receiving system, it is expected that the receiving system will create a patient record using the patient identifiers and demographics from the available PID segment data.

4260

It is the responsibility of the Image Manager and the Report Manager to ensure that the patient information has been updated in the diagnostic reports and evidence objects (e.g., images, Key Image Notes, Grayscale Softcopy Presentation States, Evidence Documents, etc.) they manage when they are retrieved.

4265 **4.12.4.5 Patient Management – Cancel Patient Transfer/Discharge**

4.12.4.5.1 Trigger Events

The following events will trigger one of the Cancel messages:

- A12 – Transfer of a patient from one location to another has been cancelled due to error in the information or the decision not to transfer the patient.
- A13 – Discharge of a patient has been cancelled due to error in the information or the decision not to discharge the patient.

4270

4.12.4.5.2 Message Semantics

Patient Transfer/Discharge conveyed by the HL7 ADT^A02 or ADT^A03 messages may have to be revoked due to the errors in the information or the decision of not transferring/discharging patient. Cancellation transaction is conveyed by the HL7 ADT^A12 or ADT^A13 messages. ADT^A12 shall be used to revoke transaction conveyed by the ADT^A02 message. ADT^A13 shall be used to revoke the transaction conveyed by the ADT^A03 message.

4275

Cancellation messages shall only be used if no other transactions were performed by the ADT on the patient record after the Patient Transfer/Discharge transaction was conveyed.

4280

Each message shall be acknowledged by the HL7 ACK message sent by the receiver of ADT message to its sender. See Section 2.4.3 “Acknowledgement Modes” for definition and discussion of the ACK message.

4.12.4.5.2.1 Message Semantics (HL7 v2.3.1)

4285

The segments of the message listed below are required, and their detailed descriptions are provided in subsections below. All other segments are optional.

Note: Additional qualifications to the level of specification and HL7 profiling are stated in Section 2.3.

ADT	Patient Administration Message	Chapter in HL7 2.3.1 and HL7 v2.5.1
MSH	Message Header	2
EVN	Event Type	3
PID	Patient Identification	3
PV1	Patient Visit	3

4.12.4.5.2.1.1 MSH Segment (HL7 v2.3.1)

MSH segment shall be constructed as defined in the Section 2.4.2.2 “Message Control”.

4290 Field *MSH-9 Message Type* shall have at least two components. The first component shall have a value of “ADT”; the second component shall have values of A12 or A13 as appropriate. The third component is optional; however, if present, it shall have a value of ADT_A12 (for the A12 message) or ADT_A01 (for A13 message).

4.12.4.5.2.1.2 EVN Segment (HL7 v2.3.1)

4295 See Section 4.1.4.1.2.1.2 for required and optional fields of the EVN segment.

4.12.4.5.2.1.3 PID Segment (HL7 v2.3.1)

All of the fields in PID segment are optional, except those listed in Table 4.12-19. See Section 4.1.4.1.2.1.3 for the list of all fields of the PID segment.

Table 4.12-19: IHE Profile - PID segment

SEQ	LEN	DT	OPT	TBL#	ITEM#	ELEMENT NAME
3	20	CX	R		00106	Patient Identifier List
5	48	XP	R		00108	Patient Name
18	20	CX	C		00121	Patient Account Number

4300

Adapted from the HL7 standard, version 2.3.1

4.12.4.5.2.1.4 PV1 Segment (HL7 v2.3.1)

All of the fields in PV1 segment are optional, except those listed in Table 4.12-20. See Section 4.1.4.1.2.1.4 for the list of all fields of the PV1 segment.

Table 4.12-20: IHE Profile - PV1 Segment

SEQ	LEN	DT	OPT	TBL#	ITEM#	ELEMENT NAME
2	1	IS	R	0004	00132	Patient Class
19	20	CX	C		00149	Visit Number
51	1	IS	C	0326	01226	Visit Indicator

4305

Adapted from the HL7 standard, version 2.3.1

At least one of the fields *PID-18 Patient Account Number* or *PVI-19 Visit Number* shall be valued. Additional requirements for the presence of value in these fields may be documented in regional or national extensions to the IHE Radiology Technical Framework (See RAD TF- 4).

4310 Field *PVI-51 Visit Indicator* shall be valued with value “V” if the field *PVI-19 Visit Number* is present. May be omitted otherwise.

4.12.4.5.2.2 Message Semantics (HL7 v2.5.1 Option)

For the HL7 v2.5.1 Option, the messages used to communicate the Cancel Patient Transfer/Discharge messages are described in the following ITI Sections in the ITI Technical Framework sections:

- 4315
- ITI TF-2b:3.31.7.12 Cancel Patient Transfer (ADT^A12^ADT_A12)
 - ITI TF-2b:3.31.7.5 Cancel Discharge/End Visit (ADT^A13^ADT_A01)

4.12.4.5.2.2.1 MSH Segment (HL7 v2.5.1 Option)

4320 The MSH segment shall be constructed as defined in ITI TF-2b:3.30.5.1 MSH – Header Segment. Additional specifications for actors complying with the IHE Radiology Technical Framework are defined in Section 2.4.

Field *MSH-9-Message Type* shall have three components. The first component shall have a value of ADT. For the A12 message, the second component shall have a value of A12 and the third component shall have a value of ADT_A09. For the A13 message, the second component shall have a value of A13 and the third component shall have a value of ADT_A01.

4325 **4.12.4.5.2.2.2 EVN Segment (HL7 v2.5.1 Option)**

The EVN segment shall be constructed as defined in ITI TF-2b:3.30.5.2 EVN – Event Type Segment.

4.12.4.5.2.2.3 PID Segment (HL7 v2.5.1 Option)

4330 All of the fields in the PID segment are optional, except those listed in Table 4.12-21. See ITI TF-2b:3.30.5.3 for a list of all of the fields of the PID segment.

Table 4.12-21: IHE Profile - PID segment

SEQ	LEN	DT	OPT	TBL#	ITEM#	ELEMENT NAME
3	250	CX	R		00106	Patient Identifier List
5	250	XPN	R		00108	Patient Name
18	250	CX	C		00121	Patient Account Number

Adapted from the HL7 standard, version 2.5.1

4.12.4.5.2.4 PV1 Segment (HL7 v2.5.1 Option)

4335 Most of the fields in the PV1 segment are optional, except those listed in Table 4.12-22. See ITI TF-2b:3.30.5.4 for a list of all of the fields of the PV1 segment.

Table 4.12-22: IHE Profile - PV1 Segment

SEQ	LEN	DT	OPT	TBL#	ITEM#	ELEMENT NAME
2	1	IS	R	0004	00132	Patient Class
19	250	CX	C		00149	Visit Number
51	1	IS	C	0326	01226	Visit Indicator

Adapted from the HL7 standard, version 2.5.1

4340 At least one of the fields *PID-18 Patient Account Number* or *PV1-19 Visit Number* shall be valued. Additional requirements for the presence of value in these fields may be documented in regional or national extensions to the IHE Radiology Technical Framework (See RAD TF-4).

Field *PV1-51 Visit Indicator* shall be valued with value “V” if the field *PV1-19 Visit Number* is valued. It may be omitted otherwise.

4.12.4.5.3 Expected Actions

4345 If the patient record was modified as a result of Patient Transfer/Discharge transaction, it shall be reverted.

4.13 Procedure Update [RAD-13]

4350 This section corresponds to Transaction RAD-13 of the IHE Technical Framework. Transaction RAD-13 is used by the Department System Scheduler/Order Filler, Report Manager and Image Manager Actors.

4.13.1 Scope

4355 This transaction involves changes to procedure information communicated from the Department System Scheduler to the Image Manager and Report Manager. Unlike the order message sent between the Order Placer and Order Filler (where only the order status can be updated without requiring a Cancel/New Order to change an order), the ORM or OMI (HL7 v2.5.1 Option) message from the Department System Scheduler/Order Filler and Image Manager may reference a previously scheduled Requested Procedure identified by a Study Instance UID.

4360 The organization operating the DSS/OF and the Image Manager/Image Archive is responsible for synchronizing Procedure and Protocol Codes between all the systems that use such codes. IHE does not yet define a common mechanism for code synchronization or access.

4.13.2 Use Case Roles

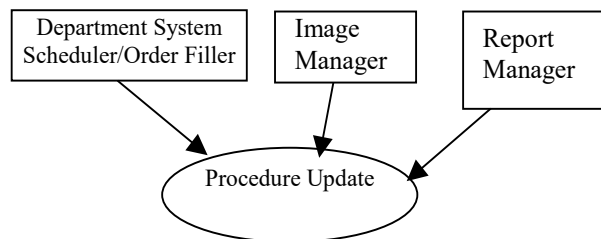

Actor: Department System Scheduler/Order Filler

4365 **Role:** Responsible for scheduling placed orders and sending the timing, resource, procedure and other information to the Image Manager.

Actor: Image Manager

Role: May use the scheduling, resource, procedure, and other information to perform image management tasks such as auto routing or pre fetching of images.

4370 **Actor:** Report Manager

Role: May use the scheduling, resource, procedure, and other information to perform detailed report scheduling tasks.

4.13.3 Referenced Standards

4375 HL7 v2.3.1 Chapters 2, 4

HL7 v2.5.1 Chapters 2, 4

4.13.4 Interaction Diagram

The following diagrams illustrate interactions between actors implementing HL7 v2.3.1:

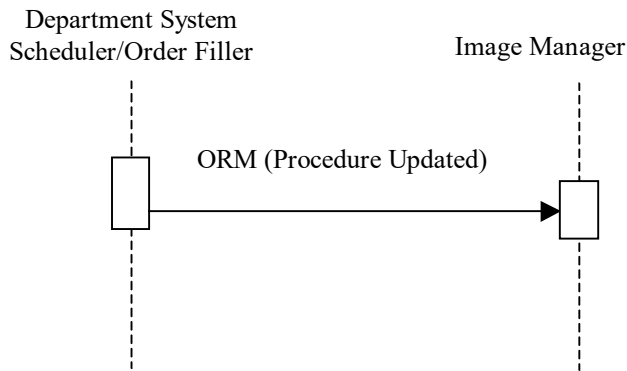

4380

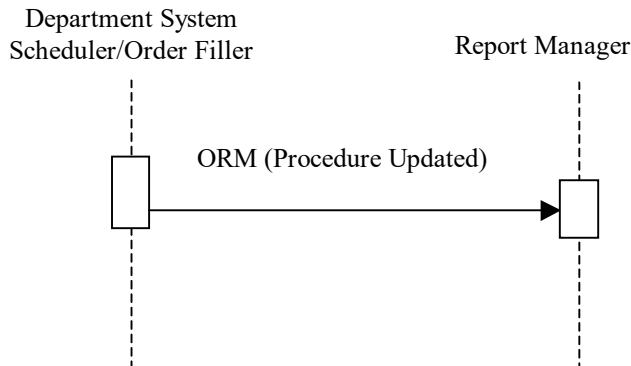

The following diagram illustrates interactions between actors implementing HL7 v2.5.1:

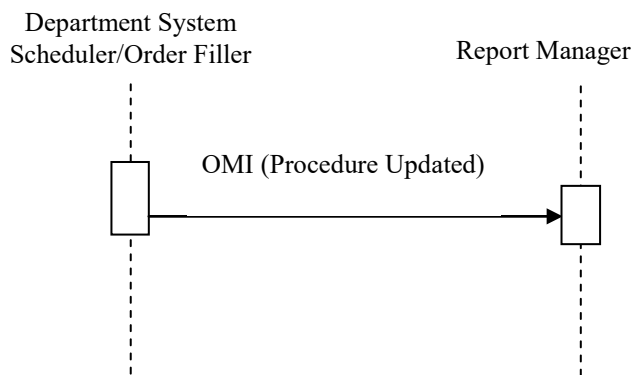
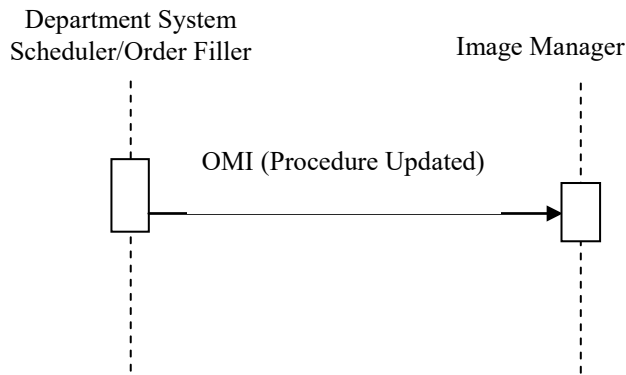

4385

4.13.4.1 Trigger Events

4390 A Procedure Update transaction is triggered in the case when the Department System Scheduler cancels, re-schedules or modifies characteristics of the procedure it previously scheduled and transmitted to the Image Manager and Report Manager via a Procedure Scheduled [RAD-4] transaction.

4.13.4.2 Message Semantics

4.13.4.2.1 Message Semantics (HL7 v2.3.1)

4395 The Procedure Update transaction is conveyed by the HL7 ORM message formatted according to the rules described in Section 4.4.

The following Order Control Codes and Order Statuses are applicable for use in the *ORC-1* and *ORC-5* fields respectively.

4400

Table 4.13-1: IHE Profile - Required Order Control Codes and Order Statuses

ORC-1 Value	ORC-1 Description	Originator	ORC-5 Value
CA	Cancel order request	DSS	CA
DC	Discontinue order request	DSS	CA
XO	Change order request, order is still scheduled or in progress	DSS	SC
XO	Change order request, order has been completed	DSS	CM

Adapted from the HL7 Standard, version 2.3.1

4405 The value of the field *ORC-5 Order Status* shall reflect status of the underlying order. If the order has been cancelled by either the Order Placer or the Order Filler, the value in the field *ORC-5* shall be set to 'CA'. In particular, if the field *ORC-1* is sent with the values of 'CA' or 'DC', the field *ORC-5* will be valued as 'CA'. If the order is changed and is still scheduled or in progress, *ORC-1* is set to 'XO' and *ORC-5* will be valued as 'SC'.

If the order is changed and has been completed, *ORC-1* is set to 'XO' and *ORC-5* will be valued as 'CM'. (This is done by the DSS/OF to update or synchronize procedure information with the IM/IA in the case the modality performed a procedure other than what was originally requested).

4410 Only procedural information that is conveyed in the OBR and ORC segments of the message may be changed. Any updates of patient or visit information shall be performed by Transaction RAD-12, Patient Update (see Sections 4.1 and 4.12 for PID and PV1 information and updates).

All (ORC, OBR) segment pairs sent in the Procedure Scheduled message shall be present in the Procedure Update message, not only the pairs introducing a change.

4415 The ORC and OBR elements given in Table 4.13-2 shall not be altered after the initial Procedure Scheduled (Section 4.4), regardless of the type of control code.

Table 4.13-2: Procedure Update Elements that shall not be changed

Element Name	Element Number(s)
Placer Order Number	OBR-2, ORC-2
Filler Order Number	OBR-3, ORC-3
Placer Group Number	ORC-4
Study Instance UID	ZDS-1

Any other elements in the OBR or ORC segments may be changed when the Order Control Code = XO.

4420 Note: Additional information regarding HL7 conventions, profiling, and implementation considerations are given in Section 2.3.

4.13.4.2.2 Message Semantics (HL7 v2.5.1)

4425 Actors claiming the HL7 v2.5.1 Option shall implement the contents of this section. When an actor claims support for the HL7 v2.5.1 Option the actor is required to support the HL7 v2.5.1 interface requirements described in the referenced volumes and sections. The actor shall still support the HL7 v2.3.1 version of the transactions.

The Procedure Update message is conveyed by the HL7 OMI message formatted according to the rules described in Section 4.4.

4430 The following Order Control Codes and Order Statuses are applicable for use in the *ORC-1* and *ORC-5* fields respectively.

Table 4.13-3: IHE Profile - Required Order Control Codes and Order Statuses

ORC-1 Value	ORC-1 Description	Originator	ORC-5 Value
CA	Cancel order request	DSS	CA
DC	Discontinue order request	DSS	CA
XO	Change order request, order is still scheduled or in progress	DSS	SC
XO	Change order request, order has been completed	DSS	CM

Adapted from the HL7 Standard, version 2.5.1

4435 The value of field *ORC-5-Order Status* shall reflect the status of the underlying order. If the order has been cancelled by either the Order Placer or the Order Filler, the value in field *ORC-5* shall be set to *CA*. In particular, if field *ORC-1* is sent with a value of *CA* or *DC*, field *ORC-5* shall be valued *CA*. If the order is changed and is still scheduled or in progress, *ORC-1* shall be valued *XO* and *ORC-5* shall be valued *SC*.

4440 If the order is changed and has been completed, *ORC-1* shall be valued *XO* and *ORC-5* shall be valued *CM*. (This is done by the DSS/OF to update or synchronize procedure information with the *IM/IA* in the case the modality performed a procedure other than what was originally requested.)

Only procedural information that is conveyed in the *OBR* and *ORC* segments of the message may be changed. Any updates of patient or visit information shall be performed by Transaction *RAD-12*, Patient Update (see Sections 4.1 and 4.12 for *PID* and *PV1* information and updates).

4445 All *ORC-TQ1-OBR-IPC* segment groups sent in the Procedure Scheduled message shall be present in the Procedure Update message, not only the pairs introducing a change.

The *ORC* and *OBR* elements given in Table 4.13-4 shall not be altered after the initial Procedure Scheduled message (Section 4.4), regardless of the type of control code.

4450

Table 4.13-4: Procedure Update Elements that shall not be changed

Element Name	Element Number(s)
Placer Order Number	OBR-2, ORC-2
Filler Order Number	OBR-3, ORC-3
Placer Group Number	ORC-4
Study Instance UID	IPC-3

Any other elements in the OBR or ORC segments may be changed when the Order Control Code = XO.

Note: Additional information regarding HL7 conventions, profiling, and implementation considerations are given in Section 2.3.

4455

4.13.4.3 Expected Actions

The Image Manager and Report Manager are expected to perform the following actions based on the value of the field *ORC-1 Order Control Code*:

4460

CA – Procedure has been cancelled, usually due to the cancellation of the underlying order; the Image Manager and the Report Manager shall inactivate corresponding procedure information using Study Instance UID as a unique key of the Requested Procedure in question. Information from PID and PV1 segments shall not be used to update patient or visit information. If the Department System Scheduler/Order Filler has been notified that a Performed Procedure Step is in progress for a Requested Procedure, the order control code DC shall be used.

4465

XO – Procedure-related information (including scheduled date/time and/or resource) has been changed. The Image Manager and Report Manager shall modify corresponding procedure information using the Study Instance UID as a unique key of the procedure in question. Information from PID and PV1 segments shall not be used to update patient or visit information.

4470

DC – Order to which the particular procedure is related has been discontinued after at least one Performed Procedure Step for this procedure has started. The Image Manager and the Report Manager shall consider all remaining SPS known for that procedure (if any) cancelled. The Image Manager shall use the Study Instance UID as a unique key of the procedure in question. Information from PID and PV1 segments shall not be used to update patient information.

4.14 Query Images [RAD-14]

4475 This section corresponds to Transaction RAD-14 for the IHE Technical Framework. Transaction RAD-14 is used by the Image Archive and Image Display Actors.

4.14.1 Scope

The Image Display queries the Image Archive for study, series and image instances for retrieval.

4.14.2 Use Case Roles

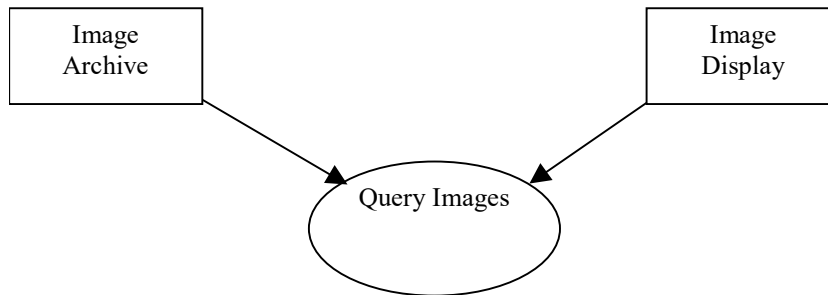

4480

Actor: Image Archive

Role: Responds to queries for Studies, Series, and Images.

Actor: Image Display

Role: Issues Queries for Studies, Series, Images

4.14.3 Referenced Standards

DICOM PS 3.4: Query/Retrieve Service Class

4.14.4 Interaction Diagram

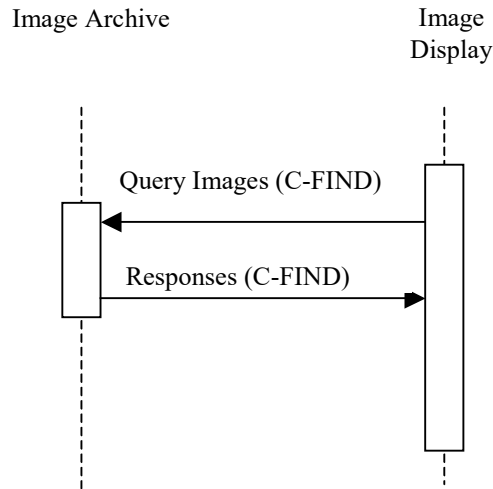

4490 **4.14.4.1 Query Images**

The Query (Study Root – FIND and optionally Patient Root – FIND) SOP Classes shall be supported. Refer to DICOM PS 3.4 for detailed descriptive semantics.

4.14.4.1.1 Trigger Events

The user at the Image Display wishes to view selected images.

4495 **4.14.4.1.2 Message Semantics**

The message semantics are defined by the DICOM Query/Retrieve SOP Classes.

A C-FIND Request from the DICOM Study Root Query/Retrieve Information Model – FIND SOP Class or optionally the DICOM Patient Root Query/Retrieve Information Model – FIND SOP Class shall be sent from the Image Display to the Image Archive. Hierarchical Search Method shall be supported.

4500

The Image Display uses one or more matching keys as search criteria to obtain the list of matching entries in the Image Archive at the selected level (Patient & Study/Series/Image). Based on this list of entries, the Image Display may select relevant entries to be retrieved.

4505

The matching keys and return keys to be supported by the Image Display (SCU) and the Image Manager (SCP) are defined in Table 4.14-1 below. The table includes the definition of return and matching keys specified by DICOM. The table specifies for both the Query SCU (Image Display) and the Query SCP (Image Archive) whether Matching Keys (keys used as matching criteria in the Query request) and Returned Keys (Keys used to request attributes to be returned in the query responses) are Required (R) or Optional (O). Requirements indicated with R+ or R+* highlight the requirements added by the IHE Radiology Technical Framework. See Section 2.2 for more information.

4510

Table 4.14-1: Images Query Matching and Return Keys

Attributes Name	Tag	Query Keys Matching		Query Keys Return		Notes
		SCU	SCP	SCU	SCP	
Study Level						
Study Date	(0008,0020)	R+	R	R+	R	
Study Time	(0008,0030)	R+	R	R+	R	
Accession Number	(0008,0050)	R+	R	R+	R	
Patient Name	(0010,0010)	R+	R	R+	R	IHE-1, IHE-2
Patient ID	(0010,0020)	R+	R	R+	R	
Study ID	(0020,0010)	R+	R	R+	R	
Study Instance UID	(0020,000D)	R+*	R	R+*	R	IHE-5
Modalities in Study	(0008,0061)	R+	R+	R+	R+	
Referring Physician's Name	(0008,0090)	R+	R+	R+	R+	IHE-1, IHE-2
Study Description	(0008,1030)	O	O	O	O	
Procedure Code Sequence	(0008,1032)					
>Code Value	(0008,0100)	O	O	O	O	
>Coding Scheme Designator	(0008,0102)	O	O	O	O	
>Coding Scheme Version	(0008,0103)	O	O	O	O	
>Code Meaning	(0008,0104)	O	O	O	O	
Name of Physician(s) Reading Study	(0008,1060)	O	O	O	O	IHE-1, IHE-2
Admitting Diagnoses Description	(0008,1080)	O	O	O	O	
Referenced Study Sequence	(0008,1110)					
>Referenced SOP Class UID	(0008,1150)	O	O	O	O	
>Referenced SOP Instance UID	(0008,1155)	O	O	O	O	
Referenced Patient Sequence	(0008,1120)					
>Referenced SOP Class UID	(0008,1150)	O	O	O	O	
>Referenced SOP Instance UID	(0008,1155)	O	O	O	O	
Patient's Birth Date	(0010,0030)	O	O	R+	R+	
Patient's Birth Time	(0010,0032)	O	O	O	O	
Patient's Sex	(0010,0040)	O	O	R+	R+	
Other Patient IDs	(0010,1000)	O	O	O	O	

Attributes Name	Tag	Query Keys Matching		Query Keys Return		Notes
		SCU	SCP	SCU	SCP	
Other Patient Names	(0010,1001)	O	O	O	O	IHE-1, IHE-2
Patient's Age	(0010,1010)	O	O	O	O	
Patient's Size	(0010,1020)	O	O	O	O	
Patient's Weight	(0010,1030)	O	O	O	O	
Ethnic Group	(0010,2160)	O	O	O	O	
Occupation	(0010,2180)	O	O	O	O	
Additional Patient History	(0010,21B0)	O	O	O	O	
Patient Comments	(0010,4000)	O	O	O	O	
Other Study Numbers	(0020,1070)	O	O	O	O	
Number of Patient Related Studies	(0020,1200)	N/A	N/A	O	O	
Number of Patient Related Series	(0020,1202)	N/A	N/A	O	O	
Number of Patient Related Instances	(0020,1204)	N/A	N/A	O	O	
Number of Study Related Series	(0020,1206)	N/A	N/A	O	R+	
Number of Study Related Instances	(0020,1208)	N/A	N/A	O	R+	
Interpretation Author	(4008,010C)	O	O	O	O	IHE-1, IHE-2
Series Level						
Modality	(0008,0060)	R+	R	R+	R	
Series Number	(0020,0011)	R+	R	R+	R	
Series Instance UID	(0020,000E)	R+*	R	R+*	R	IHE-5
Number of Series Related Instances	(0020,1209)	N/A	N/A	O	R+	
Series Description	(0008,103E)	O	O	R+	R+	
Performed Procedure Step ID	(0040, 0253)	O	O	O	O	
Referenced Performed Procedure Step Sequence	(0008,1111)					
>Referenced SOP Class UID	(0008,1150)	O	O	O	O	
>Referenced SOP Instance UID	(0008,1155)	O	O	O	O	
Request Attribute Sequence	(0040, 0275)					IHE-3
>Requested Procedure ID	(0040,1001)	R+	R+	R+	R+	
>Scheduled	(0040,0009)	R+	R+	R+	R+	

Attributes Name	Tag	Query Keys Matching		Query Keys Return		Notes
		SCU	SCP	SCU	SCP	
Procedure Step ID						
Performed Procedure Step Start Date	(0040,0244)	R+	R+	R+	R+	
Performed Procedure Step Start Time	(0040,0245)	R+	R+	R+	R+	
Body Part Examined	(0018,0015)	O	O	O	O	
Composite Object Instance Level						
Instance Number	(0020,0013)	O	R	O	R	
SOP Instance UID	(0008,0018)	O	R	O	R	
SOP Class UID	(0008,0016)	O	R+	O	R+	IHE-4

Note: For a description of the notation/ modifiers used in the above table, see Section 2.2.

4515 The table below extends the table above with image-specific keys.

Table 4.14-2: Image Specific Query Matching and Return Keys

Attribute Name	Tag	Query Keys Matching		Query Keys Return		Notes
		SCU	SCP	SCU	SCP	
Image Specific Level						
Rows	(0028,0010)	O	O	O	R+	
Columns	(0028,0011)	O	O	O	R+	
Bits Allocated	(0028,0100)	O	O	O	R+	
Number of Frames	(0028,0008)	O	O	O	R+	

4520 The SCP is required (R+) to support the query return key elements: Rows, Columns, Bits Allocated and Number of Frames for calculating the storage size needed for retrieving (storing) the images. Furthermore, the image Bits Allocated is used in matching the image pixel bit depth to the Hard Copy Device (Printer) pixel bit depth.

- **IHE-1:** Case insensitive matching is allowed for attributes of VR PN per DICOM PS 3.4.
- **IHE-2:** SCUs are recommended to append wildcard “*” at the end of each component of any structured name to facilitate matching (i.e., PN attributes).
- 4525 • **IHE-3:** Universal Matching (selecting return keys) against an Attribute of VR SQ, may be requested by the Query SCU using a Zero Length Sequence Attribute. Query SCUs shall accept such Universal Match Requests. In addition, Query SCUs are required by the DICOM Standard to support requests for a Universal Match for an SQ attribute encoded as a zero length item.
- 4530 • **IHE-4:** A SOP Class UID is a non-ambiguous key to identify a specific type of image (Modality is not).

- 4535 • **IHE-5:** SCUs shall be able to include Study and Series UIDs as Matching Keys in queries. UID values will most probably originate from actor-internal logic that was performed prior to the Image Query, not from direct user input. For instance, an Image Display wants to display images of a series that is referenced in a DICOM Presentation State instance it just has retrieved - it includes the Series Instance UID value from the Presentation State as a query matching key.

4.14.4.1.3 Expected Actions

4540 The Image Archive receives the C-FIND request, performs the matching on the provided keys and sends the list of matching records back to the Image Display via C-FIND responses. It is the responsibility of the Image Manager to ensure that the patient and procedure information is current in the images when they are retrieved from the Image Archive. The patient and procedure information is updated through transactions RAD-12 and RAD-13.

4545 This means the Image Display may receive patient data inconsistent with those received from a previously issued query or retrieve operation. For example, in the event that a patient has been renamed, the Image Display will receive images with the same Study Instance UID, Series Instance UID and SOP Instance UIDs, but with a different patient name. The Image Display shall use the just queried information or the most recently received instances to ensure that the most recent patient data from the Image Manager/Archive is displayed.

4550

4.15 Query Presentation States [RAD-15]

This section corresponds to Transaction RAD-15 of the IHE Technical Framework. Transaction RAD-15 is used by the Image Archive and Image Display Actors.

4.15.1 Scope

4555 This section describes the sequence of messages required for the Image Display to query the Image Archive for instances of Grayscale Softcopy Presentation States. The Image Display will query and then retrieve Presentation State objects together with the image data referenced in the return keys supplied in the response from the Image Archive or referenced in the Presentation State object. The transformations will be applied by the Image Display to the image data to assure the image display is consistent with the device that originally created and stored the Presentation State. The Image Display will be required to support all transformations defined in DICOM PS 3.4: Grayscale Softcopy Presentation State Storage. In addition, multiple Presentation States may exist that reference the same image data.

4.15.2 Use Case Roles

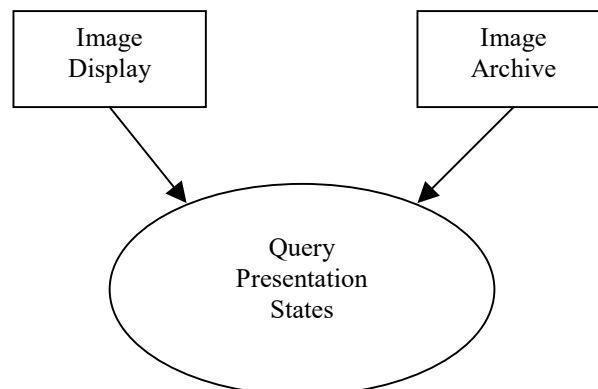

4565

Actor: Image Display

Role: Query for Grayscale Softcopy Presentation State objects together with the referenced image data and apply the transformations specified by the Presentation State. This actor must support pixel rendering according to the Grayscale Standard Display Function (GSDF) defined in DICOM PS 3.14. This device will implement the Query/Retrieve SOP Classes in the role of SCU.

4570

Actor: Image Archive

Role: Respond to queries from the Image Display for Grayscale Softcopy Presentation States objects. This device will implement the Query/Retrieve SOP Classes in the role of SCP.

4.15.3 Referenced Standards

4575

DICOM PS 3.4: Query/Retrieve Service Class

DICOM PS 3.14: Grayscale Standard Display Function

4.15.4 Interaction Diagram

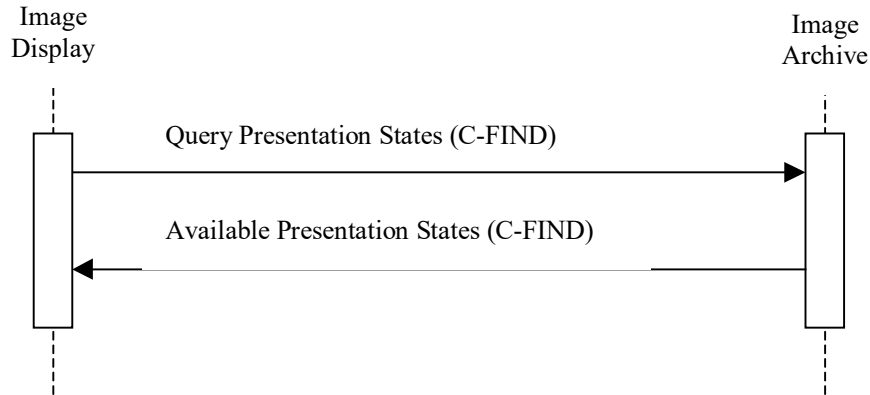

4580 **4.15.4.1 Query for Grayscale Softcopy Presentation States**

The Query (Study Root – FIND and optionally Patient Root – FIND) SOP Classes will be supported. Refer to DICOM PS 3.4: Query/Retrieve Service Class for detailed descriptive semantics.

4.15.4.1.1 Trigger Events

4585 The user of the Image Display wishes to query instances of Grayscale Softcopy Presentation States.

4.15.4.1.2 Message Semantics

4590 The message semantics are defined by the DICOM Query/Retrieve SOP Classes: A C-FIND Request from the DICOM Study Root Query/Retrieve Information Model – FIND SOP Class or the optional DICOM Patient Root Query/Retrieve Information Model – FIND SOP Class. The C-FIND request shall be sent from the Image Display to the Image Archive.

The matching keys and return keys to be supported by the Image Display (SCU) and the Image Archive (SCP) at the Study and Series level are defined in Table 4.14-1.

4595 Table 4.15-1 below specifies for both the Query SCU (Image Display) and the Query SCP (Image Archive), additional Matching Keys (keys used as matching criteria in the Query request) and Return Keys (keys used to request attributes to be returned in the query responses) that are Required (“R”) or Optional (“O”), specific (or pertaining) to Presentation State. See Section 2.2 for more information.

4600

Table 4.15-1: Presentation State Specific Query Matching and Return Keys

Attribute Name	Tag	Query Keys Matching		Query Keys Return	
		SCU	SCP	SCU	SCP
Presentation Label	(0070,0080)	O	O	R+	R+
Presentation Description	(0070,0081)	O	O	O	R+
Presentation Creation Date	(0070,0082)	O	O	R+	R+
Presentation Creation Time	(0070,0083)	O	O	R+	R+
Presentation Creator's Name	(0070,0084)	O	O	R+	R+
Referenced Series Sequence	(0008,1115)				
>Series Instance UID	(0020,000E)	O	O	O	R+
>Referenced Image Sequence	(0008,1140)				
>>Referenced SOP Class UID	(0008,1150)	O	O	O	R+
>>Referenced SOP Instance UID	(0008,1155)	O	O	O	R+

4.15.4.1.3 Expected Actions

4605

The Image Archive receives the C-FIND request, matches on the provided keys and sends the list of matching records back to the Image Display via C-FIND responses. It is the responsibility of the Image Manager to ensure that the patient and procedure information is current in the images and Softcopy Presentation State objects when they are retrieved from the Image Archive. The patient and procedure information is updated through transactions RAD-12 and RAD-13.

4610

This means the Image Display may receive patient data inconsistent with those received from a previously issued query or retrieve operation. For example, in the event that a patient has been renamed, the Image Display will receive Softcopy Presentation State objects with the same Study Instance UID, Series Instance UID and SOP Instance UIDs, but with a different patient name. The Image Display shall use the just queried information or the most recently received instances to ensure that the most recent patient data from the Image Manger/Archive is displayed.

4.16 Retrieve Images [RAD-16]

4615 This section corresponds to Transaction RAD-16 of the IHE Technical Framework. Transaction RAD-16 is used by an Image Display to request and retrieve images from an Image Archive and the Imaging Document Consumer to request and retrieve documents from an Imaging Document Source.

4.16.1 Scope

4620 After the Image Display or Imaging Document Consumer request for image retrieval, the requested DICOM Images are transferred from the Image Archive to the Image Display or from the Imaging Document Source to the Imaging Document Consumer for viewing.

4.16.2 Use Case Roles

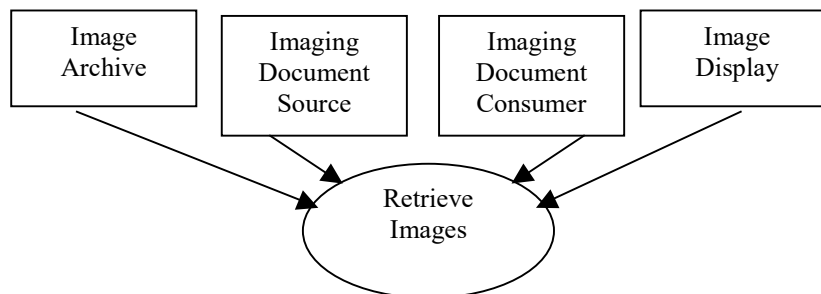

4625 **Actor:** Image Archive

Role: Sends requested images to the Image Display.

Actor: Imaging Document Source:

Role: Sends requested images to the Imaging Document Consumer.

Actor: Image Display

4630 **Role:** Receives requested images from the Image Archive.

Actor: Imaging Document Consumer

Role: Receives requested images from the Imaging Document Source.

4.16.3 Referenced Standards

DICOM PS 3.4: Storage Service Class

4635 DICOM PS 3.4: Query/Retrieve Service Class

4.16.4 Interaction Diagram

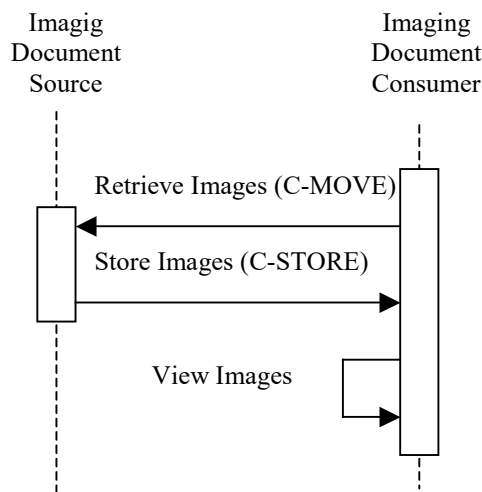
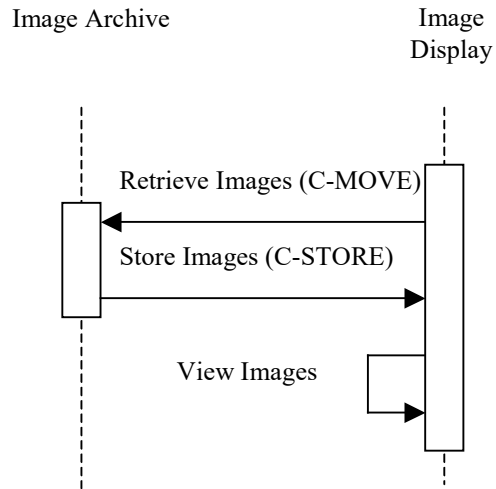

4640 4.16.4.1 Retrieve Images

The Retrieve (Study Root – MOVE and optionally Patient Root – MOVE) SOP Classes shall be supported. The DICOM Image Storage SOP Classes will be supported by the Image Archive or Imaging Document Source as an SCU. Refer to DICOM PS 3.4, Annex C, for detailed descriptive semantics.

4645 In the case of retrieving images in a Cross-Enterprise, imaging document sharing (XDS-I) network environment, a configuration of mapping the AE Titles to DICOM AE Network Addresses (IP Address and Port number) are needed to be exchanged between the Imaging Document Source and the Imaging Document Consumer. RAD TF-3: Appendix G describes in details the AE Title mapping to the DICOM AE Network Addresses.

4650 **4.16.4.1.1 Trigger Events**

Images are selected for viewing at the Image Display or Imaging Document Consumer.

4.16.4.1.2 Message Semantics

The message semantics are defined by the DICOM Query/Retrieve SOP Classes and the DICOM Image Storage SOP Classes.

4655 A C-MOVE Request from the DICOM Study Root Query/Retrieve Information Model – MOVE SOP Class or the DICOM Patient Root Query/Retrieve Information Model – MOVE SOP Class shall be sent from the Image Display to the Image Archive or from the Imaging Document Consumer to the Imaging Document Source.

4.16.4.1.3 Expected Actions

4660 The Image Archive or Imaging Document Source receives the C-MOVE request, establishes a DICOM association with the Image Display or Imaging Document Consumer, respectively, and uses the appropriate DICOM Image Storage SOP Classes to transfer the requested images. The Image Display or Imaging Document Consumer is expected to support at least one of the SOP Classes specified in Table 4.8-1. It is assumed that support of retrieval for a SOP Class also
4665 means support for display.

4.16.4.1.3.1 NM Image Profile

Image Manager/Image Archive, Imaging Document Source, Image Displays and Imaging Document Consumer Actors that claim the NM Image Profile shall support all the SOP Classes specified in Table 4.8-3 in Section 4.8.

4670 **4.16.4.1.3.2 Mammography Image Profile**

Image Manager/Image Archive Actors supporting the Mammography Image Profile shall support all the SOP Classes specified in Table 4.16.4.1.3.2-1.

An Image Display supporting the Mammography Image Profile shall support all the SOP Classes specified in Table 4.16.4.1.3.2-1.

4675 **Table 4.16.4.1.3.2-1: Mammography SOP Classes for Display**

SOP Class UID	SOP Class Name
1.2.840.10008.5.1.4.1.1.1.2	Digital Mammography Image Storage – For Presentation

Note that Image Displays are not required to support “For Processing” images.

4.16.4.1.3.3 Basic Image Review Profile

This section intentionally, temporarily left blank.

4680 **4.16.4.1.3.4 MR Diffusion Imaging Profile**

This section intentionally, temporarily left blank.

4.16.4.1.3.5 CT/MR Perfusion Imaging with Contrast Profile

This section intentionally, temporarily left blank.

4.16.4.1.3.6 Streatactic Mammography Image Profile

4685 This section intentionally, temporarily left blank.

4.16.4.1.3.7 Digital Breast Tomosynthesis Profile

Image Display and Image Manager/Image Archive Actors in the Digital Breast Tomosynthesis Profile shall support retrieval of the SOP Classes with the optionality specified in Table 4.16.4.1.3.7-1.

4690 **Table 4.16.4.1.3.7-1: DBT SOP Classes for Retrieval**

SOP Class UID	SOP Class Name	Optionality (Image Display)	Optionality (IM/IA)
1.2.840.10008.5.1.4.1.1.13.1.3	Breast Tomosynthesis Image Storage	R	R
1.2.840.10008.5.1.4.1.1.1.2	Digital Mammography X-Ray Image Storage – For Presentation	R	R
1.2.840.10008.5.1.4.1.1.1.2.1	Digital Mammography X-Ray Image Storage – For Processing	O	R

Image Displays may support the transfer syntaxes listed in Table 4.8.4.1.2.7-4.

Image Displays are only expected to support a single traversal of a volume stored in a Breast Tomosynthesis Image Storage instance (i.e., Image Position (Patient) (0020, 0032) has a different value for each frame).

4695 Image Manager/ Image Archives participating in the Digital Breast Tomosynthesis Profile shall support the compression transfer syntaxes as listed in Table 4.8.4.1.2.7-4 for retrieval.

4.16.4.2 View Images

This transaction relates to the “View Images” event of the above interaction diagram.

4.16.4.2.1 Trigger Events

4700 The Image Display or Imaging Document Consumer is requested to be capable to display the images.

4.16.4.2.2 Invocation Semantics

This is a local invocation of functions at the Image Display or Imaging Document Consumer.

4.16.4.2.2.1 Display of Digital X-Ray, Mammo and Intra-Oral Images

4705 For the Breast Tomosynthesis Image, “For Presentation” variant of the Digital X-Ray Image, the
Digital Mammography X-Ray Image, and the Digital Intra-oral X-Ray Image, the Image Display
or Imaging Document Consumer shall have both the capability to apply all the transformations
specified by the VOI LUT Sequence (0028,3010) and the capability to apply all the
4710 transformations specified by the Window Width (0028,1051)/Window Center (0028,1050)/VOI
LUT Function (0028,1056) attributes as selected by the user from the choices available (e.g.,
guided by Window Center/Width Explanation (0028,1055) or LUT Explanation(0028,3003).
These attributes may be nested in a Functional Groups Sequence depending on the SOP Class,
If VOI LUT Function (0028,1056) is absent, then Window Width (0028,1051)/Window Center
(0028,1050) shall be assumed to be the parameters of a linear window operation. VOI LUT
4715 Function (0028,1056) values of “SIGMOID” and “LINEAR” shall be supported.

The Image Display or Imaging Document Consumer shall support the application of LUT Data
(0028,3006) in items of the VOI LUT Sequence (0028,3010) regardless of the Value
Representation (i.e., the DICOM standard allows either OW or US Value Representation).

4720 The Image Display or Imaging Document Consumer must also support pixel rendering according
to the Grayscale Standard Display Function (GSDF) defined in DICOM PS 3.14, because the
output values of these images are always P-Values.

If the DICOM image is referenced by other DICOM composite objects, such as Grayscale
Softcopy Presentation States, it is optional for the Image Display or Imaging Document
Consumer to actually retrieve and display/apply these objects.

4725 4.16.4.2.2.1.1 Display of Digital Mammography Images

The contents of this section are required for Image Display claiming the Mammography Image
Profile.

4730 The following requirements are intended to establish a baseline level of capabilities. Providing
more intelligent and advanced capabilities is both allowed and encouraged and the profile is not
intended to be limiting in any way with respect to capabilities. The intention is not to dictate
implementation details.

All mammography Image Display Actors shall support the Retrieve Images transaction for “For
Presentation” images.

4735 The Image Display shall be capable of displaying simultaneously a set of current and prior
conventional four view screening mammogram images (left and right CC and MLO views),
regardless of whether these images are in one or multiple DICOM Series.

4740 An Image Display that supports the Mammography Image Profile shall support calibration as
described in the DICOM Grayscale Standard Display Function (GSDF). The minimum and
maximum luminance of the display shall be configurable by the site, within the gamut of the
device, for the purpose of conforming to local, regional or national regulatory and other
requirements for luminance settings throughout the organization. For example, a site may require

that all Image Displays used for primary interpretation be calibrated to the same minimum and maximum luminance.

4.16.4.2.2.1.1.1 Background Air Suppression

4745 Image Display Actors shall be capable of recognizing pixels that have the value specified in Pixel Padding Value (0028,0120) when present alone, and between Pixel Padding Value (0028,0120) and Pixel Padding Range Limit (0028,0121) inclusive when both elements are present, and setting them to a minimum display value that is not affected by image contrast adjustments, including inversion of the image contrast.

4.16.4.2.2.1.1.2 Image Orientation and Justification

Image Display Actors shall not assume that the pixel data is encoded with an orientation that is suitable for direct display to the user without flipping or rotating into the correct orientation.

4755 The Image Display shall use the values of Image Laterality (0020,0062), View Code Sequence (0054,0220), View Modifier Code Sequence (0054,0222) and Patient Orientation (0020,0020) to display images according to the preferred hanging protocol of the current user, rather than depend on descriptive attributes such as Series Description (0008,103E).

4760 The Image Display shall allow the user to select or configure hanging protocols such that given a set of images containing these attributes, the placement of images relative to one another, the required orientation of the images, the display of current and prior images, and the sequence of layouts displayed can be defined.

4765 Note that images are normally displayed such that the axilla is towards the top of the viewport, except for cleavage views (which contain two axillas). The location of the axilla can be determined from the direction of the head encoded in Patient Orientation (0020,0020) in the case of lateral and oblique views, and the Image Laterality (0020,0062) in the case of cranio-caudal or caudo-cranial views. For cleavage views, indicated by the presence of a View Modifier Code Sequence (0054,0222) Item containing (R-102D2, SNM3, “Cleavage”), either axilla may be at the top of the view port.

4770 The Image Display shall be able to distinguish and display separately images with one or more Items in a View Modifier Code Sequence (0054,0222) from each other and those without a View Modifier Code Sequence (0054,0222) Item.

4775 The Image Display shall be capable of horizontally justifying the image to the left or right side of the viewport rather than centering it, when the aspect ratio (ratio of the number of rows and columns) of the viewport does not match aspect ratio of the image, in order to avoid displaying any unnecessary padding between the adjacent chest walls of back to back images; excessive window decoration (such as scroll bars) shall not be displayed between back to back viewports.

4.16.4.2.2.1.1.3 Image Size

The physical size of the pixels in an image for the purposes of the display modes defined in this section shall be approximated by using the values of Imager Pixel Spacing (0018,1164).

4780 The physical size of the pixels in an image for the purposes of distance measurements and the display of a distance caliper shall be approximated by using the values of Imager Pixel Spacing (0018,1164) divided by Estimated Radiographic Magnification Factor (0018,1114).

4785 For contact (unmagnified) views, the value of Estimated Radiographic Magnification Factor (0018,1114) is typically 1, or close to 1, depending on the distance between the detector side of the compressed breast and the front of the detector housing (the latter being the plane in which Imager Pixel Spacing (0018,1164) is defined), and what depth the nominal location of the object plane is within the compressed breast.

4790 For magnification views, the spacing between the detector side of the compressed breast and the detector is increased substantially relative to the distance to the x-ray source to obtain geometric magnification, and Estimated Radiographic Magnification Factor (0018,1114) will have a value substantially greater than 1.

4795 Pixel Spacing (0028,0030) shall not be used to determine size for the purpose of sizing for display or distance measurements. DICOM CP 586, which clarifies the meaning of Pixel Spacing (0028,0030) values that differ from Imager Pixel Spacing (0018,1164) values when an image has been calibrated by use of a fiducial of known size within the image, is not relevant to mammography applications.

Note that the use of Imager Pixel Spacing (0018,1164) is sufficient regardless of the physical size of the detector used.

4.16.4.2.2.1.1.3.1 Same Size

4800 The Image Display shall be capable of displaying multiple images such that all images are at the same relative physical size, regardless of whether they have the same values of Imager Pixel Spacing (0018,1164) or not.

4805 For example, a user reviewing a four-view screening mammogram together with a four-view prior mammogram might want to display eight viewports, each showing one view, such that each view is at the same relative physical size, even if the images were obtained on detectors with different sized pixels. This allows the user to compare features in the prior and current images to visually assess whether or not they have changed in size.

4810 Note that it is not expected that the Image Display attempt to compensate for the location of the object within the compressed breast of finite thickness along the x-ray beam, since the convention for measurement from film-screen practice assumes that all objects are located at the cassette (detector) side of the breast.

This mode of display is not intended for comparison of geometrically magnified views at the same time as non-magnified views, since the geometrically magnified view would then be displayed too small.

4.16.4.2.2.1.1.3.2 True Size

4815 The Image Display shall be capable of displaying multiple images such that all images are true size, regardless of whether they have the same values of Imager Pixel Spacing (0018,1164) or not.

4820 True size is defined as the display of an image such that an object in the image when measured with a hand-held ruler on the surface of the display measures as closely as possible to the true physical size of the object if located on the front face of the detector housing.

This mode of display is not intended for geometrically magnified views, since the geometrically magnified view would then be displayed too small.

4.16.4.2.2.1.1.3.3 View Actual Pixels

4825 The Image Display shall be capable of displaying multiple images such that each encoded pixel occupies one display pixel in the viewport.

If the size of the pixel data exceeds the size of the viewport, it may not be possible to display all of the encoded pixels at once, in which case some form of pan or quadrant navigation functionality shall be provided.

4830 Since there is no minification or magnification, images with different pixel physical size will be displayed in this mode such that the physical size in the patient will appear different.

4.16.4.2.2.1.1.4 Image Contrast Adjustment

As described in 4.16.4.2.2.1 Display of Digital X-Ray, Mammography and Intra-Oral Images, the Image Display shall provide the user with the ability to select amongst the available window and VOI LUT choices available in the image object.

4835 Subsequent to the initial application of the chosen contrast transformation, the Image Display shall allow the user to adjust the contrast without reverting to a purely linear transformation:

- 4840 • If the chosen contrast transformation is a lookup table, then the Image Display shall allow the input value of the lookup table to be stretched and translated so as to give the effect of adjusting contrast and brightness whilst applying the same general shape as the curve encoded in the lookup table. To provide feedback to the user, the “window width” can be reported as the adjusted range of input values to the LUT, and the “window center” can be reported as the center value of that range.
- 4845 • If the chosen contrast transformation is a sigmoid shaped VOI LUT Function parameterized by the window center and width, then the Image Display shall allow the window center and width values to be adjusted and a sigmoid function reapplied.

If a Pixel Padding Value (0028,0120) only is present in the image then image contrast manipulations shall not be applied to those pixels with the value specified in Pixel Padding Value (0028,0120).

4850 If both Pixel Padding Value (0028,0120) and Pixel Padding Range Limit (0028,0121) are present in the image then image contrast manipulations shall not be applied to those pixels with values in

the range between the values of Pixel Padding Value (0028,0120) and Pixel Padding Range Limit (0028,0121), inclusive.

4.16.4.2.2.1.1.5 Annotation of Image Information

4855 Quite apart from good practice, there are nationally-specific requirements for information to be displayed (or displayable) to the user in order to ensure correct identification of the patient and study during reporting and review as well as the resolution of quality issues.

This profile defines the union of currently known and anticipated nationally-specific requirements with respect to annotation.

It is desirable that the subset of attributes displayed be configurable by the user or the site.

4860 If annotations are overlaid on the displayed image, the Image Display shall not annotate the edge that contains the chest wall, as determined from (0020,0020) Patient Orientation, so as to avoid covering breast tissue.

4.16.4.2.2.1.1.5.1 Annotation of Identification Information

4865 The Image Display shall be capable of displaying the information contained in the attributes listed in Table 4.16.4.2.2.1.1.5.1-1. The required information is defined in two categories:

- Clinical - Those attributes that are useful during interpretation and review of the images for clinical purposes, and which under normal circumstances should be displayed
- Investigative - Those attributes that are useful for investigative purposes, such as to trace a quality problem, and which under normal circumstances are a distraction and should not be displayed until requested by the user

4870

Table 4.16.4.2.2.1.1.5.1-1: Identification Attributes for Display

Attribute	Tag	Requirement
Patient's Name	(0010,0010)	Clinical
Patient ID	(0010,0020)	Clinical
Patient's Birth Date	(0010,0030)	Clinical
Patient's Age	(0010,1010)	Clinical
Acquisition Date	(0008,0022)	Clinical
Acquisition Time	(0008,0032)	Clinical
Operator's Name	(0008,1070)	Clinical
Manufacturer	(0008,0070)	Investigative
Institution Name	(0008,0080)	Clinical
Institution Address	(0008,0081)	Investigative
Manufacturer's Model Name	(0008,1090)	Investigative
Device Serial Number	(0018,1000)	Investigative
Detector ID	(0018,700A)	Investigative
Software Versions	(0018,1020)	Investigative

Attribute	Tag	Requirement
Station Name	(0008,1010)	Clinical
Gantry ID	(0018,1008)	Clinical (for CR overrides Station Name, which is plate reader)
Date of Last Detector Calibration	(0018,700C)	Investigative

Note that it is common practice to use the Operator’s Name (0008,1070) to encode the initials rather than the full name of the operator, and this is sufficient to meet known regulatory requirements.

4875 Note also that Station Name (0008,1010) (or Gantry ID (0018,1008) for CR) are typically short, human-recognizable strings meaningful to the users, and are preferred for satisfying any regulatory requirement for “mammography unit identification” over the more cryptic but precise attributes like Device Serial Number (0018,1000).

4880 The Image Display shall make the investigative set of values available to the ordinary user, but these need not necessarily be annotated directly on the image, e.g., they might be displayed in a separate pop-up window.

It shall be possible to turn on or off either set of annotations at the user’s discretion.

4.16.4.2.2.1.1.5.2 Annotation of Technical Factor Information

4885 Good practice dictates that certain technical factors be displayed (or displayable) to the user in order to detect and resolve quality issues.

4890 In addition, there are technical factors that are unique to the digital realm. One such factor is related to the adjustment of the sensitivity and/or dynamic range of the sensor or processing, corresponding to the amount of radiation reaching the detector. These are variously referred to by manufacturers as ADU, exposure index, or sensitivity. Note that interpretation of this value is vendor-specific, though may be standardized in the future by AAPM.

The Image Display shall be capable of displaying the information contained in the attributes listed in Table 4.16.4.2.2.1.1.5.2-1.

Table 4.16.4.2.2.1.1.5.2-1: Technique Attributes for Display

Attribute	Tag
KVP	(0018,0060)
Exposure	(0018,1152)
Exposure Time	(0018,1150)
Filter Material	(0018,7050)
Anode Target Material	(0018,1191)
Compression Force	(0018,11A2)
Body Part Thickness	(0018,11A0)

Attribute	Tag
Positioner Primary Angle	(0018,1510)
Relative X-ray Exposure	(0018,1405)
Entrance Dose in mGy	(0040,8302)
Organ Dose	(0040,0316)

4895 It shall be possible to turn on or off the annotations at the user’s discretion.

4.16.4.2.2.1.1.5.3 Annotation of View Information

Traditional film-screen practice requires the use of lead markers consisting of letters encoding the type of view, located in the corner of the film that is opposite the chest wall and towards the axilla.

4900 Image Displays shall mimic this practice by annotating the viewport with abbreviations derived from the value of Image Laterality (0020,0062), View Code Sequence (0054,0220) and any values of View Modifier Code Sequence (0054,0222) Items that are present.

4905 Unless otherwise overridden by nationally specific extensions, the specific abbreviations to be displayed are as defined in the View Modifier Abbreviations Column of CID 4014 and CID 4015 of DICOM PS 3.16, which is derived from ACR MQCM 1999, with the following clarifications:

- The Image Laterality shall be prepended to the abbreviation, e.g., a right CC view shall be displayed as “RCC”
- A CC view with a cleavage modifier shall be annotated as only “CV” if Image Laterality has a value of “B”, i.e., the “CC” shall not be displayed, and the laterality shall be omitted (in which case the left and right breast can be determined from the value of Patient Orientation (0020,0020)); otherwise “LCV” or “RCV” shall be used
- A right MLO view with the axillary tail modifier shall be annotated only as “RAT”, i.e., the “MLO” shall not be displayed
- The implant displaced modifier shall be appended as a suffix to the view, as if it were defined as “...ID”, e.g., a right implant displaced CC view would be annotated as “RCCID”
- A spot compression modifier shall be prepended as a prefix to the view, as if it were defined as “S...”, e.g., a left spot compression CC view would be annotated as “LSCC”
- A tangential modifier shall be annotated as only “TAN”, i.e., the “CC” or whatever else is encoded as the view, shall not be displayed
- When multiple prefix or suffix modifiers are present, they shall be sorted alphabetically, e.g., a right magnified, spot compression, implant displaced, rolled lateral CC view would be annotated as “RMSCCIDRL”

Spaces and other delimiters are permitted between components of the abbreviations.

4925 Prior to any flip or rotation for display, the location of the corner opposite the chest wall and
towards the axilla can be determined from the direction of the chest wall encoding in Patient
Orientation (0020,0020), regardless of view, and the direction of the head encoded in Patient
Orientation (0020,0020) in the case of lateral and oblique views, and the Image Laterality
4930 (0020,0062) in the case of cranio-caudal or caudo-cranial views. For cleavage views, the axilla at
the top of the viewport shall be annotated. See also 4.16.4.2.2.1.1.2 Image Orientation and
Justification.

It shall be possible to turn on or off the annotations at the user's discretion.

4.16.4.2.2.1.1.6 Annotation of Size Information

4935 For the purpose of this section, physical pixel size is as defined in Section 4.16.4.2.2.1.1.3 Image
Size.

The user needs to be aware when the displayed image does not reflect a 1:1 rendition of an
encoded image pixel to a displayed pixel, i.e., that some magnification or minification has taken
place. Anything other than 1:1 rendition may result in loss or distortion of information.

4940 Further, the user needs to be aware of whether or not the image is displayed at true size, and
whether or not different images are at the same relative physical size.

Therefore, the Image Display shall be capable of annotating the displayed images with the
following:

- 4945 • Pixel Size Magnification - Number of displayed pixels relative to the number of encoded
image pixels, such that a factor of 1.0 (or 100%) means 1:1 rendition, a factor of less than
1.0 means that one pixel on the display represents more than one pixel in the encoded
image (minification), and a factor of greater than 1.0 means that pixels in the encoded
image have been replicated or interpolated to span multiple displayed pixels
(magnification)
- 4950 • True Size Magnification - Size of the displayed pixels relative to true size, such that a
factor of 1.0 (or 100%) means true size, a factor of less than 1.0 means smaller than true
size, and a factor of greater than 1.0 means larger than true size

The exact form of these two relative pixel size indications is left to the discretion of the
implementer.

4955 The Image Display shall be capable of displaying a ruler or caliper indicating the physical size of
the displayed image, for the purpose of providing a visual cue to the user of the general size of
the features in the image. It shall be possible to turn on or off the ruler at the user's discretion.

The Image Display shall provide a means of accurately measuring distance between two points
based on the physical size of the image pixels.

4.16.4.2.2.1.1.7 Partial View Option

4960 If the Image Display supports the Partial View Option, it shall additionally annotate the
displayed image in the view port to indicate:

- when the image is a partial view, as defined by the presence of Attribute Partial View (0028,1350) with a value of YES
 - which region of the mosaic the image represents, as encoded in Partial View Code Sequence (0028,1352), if present
- 4965

Whether or not this annotation is textual or in the form of some iconic graphic representation, and whether or not any navigational or layout assistance is provided for the entire mosaic is at the discretion of the implementer.

4.16.4.2.2.1.1.8 Display of CAD Marks

- 4970 Image Displays shall be able to apply marks on the displayed image corresponding to all findings encoded in Mammography CAD SR objects with a (111056, DCM, “Rendering Intent”) value of (111150, DCM, “Presentation Required”). They may be able to display additional findings that have a (111056, DCM, “Rendering Intent”) value of (111151, DCM, “Presentation Optional”).

- 4975 The Image Display shall make the user aware that CAD marks are available for display, and indicate whether or not CAD marks are currently activated. More than one set of CAD objects could be available that are applicable to the same image (e.g., CAD was run more than once on the same images). If this is the case then all CAD SRs shall be made available for display on the review workstation with the most recent CAD SR (by Content Date/Time) being displayed by default. The user shall be able to choose which CAD SR object is to be displayed.

- 4980 Only a single CAD SR object at a time shall be applied to a displayed image.

The Image Display shall be able to apply the marks to “For Presentation” images that are referenced by the Mammography CAD SR SOP Instance.

- 4985 The Image Display shall also be able to apply the marks to “For Presentation” images whose Source Image Sequence references the SOP Instance UID of the “For Processing” images that are referenced by the Mammography CAD SR SOP Instance, unless the Spatial Locations Preserved (0028,135A) is present in the Source Image Sequence Item and has a value of NO.

- 4990 The Patient Orientation of the images referenced in the Source Image Sequence encoded in (111044, DCM, “Patient Orientation Row”) and (111043, DCM, “Patient Orientation Column”) of the Mammography CAD SR SOP Instance shall be used to transform (flip or rotate) the coordinates of the CAD marks if it differs from the Patient Orientation (0020,0020) of the corresponding “For Presentation” image.

- 4995 The form in which the CAD marks are displayed may influence observer performance, and hence it may be necessary to display them in a manner prescribed by the CAD device vendor, which is not encoded in the DICOM object. The form of the CAD mark rendering is out of the scope of this profile to define.

The Image Display shall make available for display the following information about each CAD finding, if encoded in the CAD object:

- Manufacturer (0008,0070)

- 5000
- Algorithm as defined in (111001, DCM, “Algorithm Name”) and (111003, DCM, “Algorithm Version”)
 - Operating point as defined in (111071, DCM, “CAD Operating Point”)
 - Content Date (0008,0023) and Content Time (0008,0033) of the CAD SR instance, if more than one exists and applies to the displayed image

5005 The Image Display shall indicate when CAD was not attempted or has failed, either entirely, or if some algorithms have succeeded and others failed, as distinct from when CAD has succeeded but there are no findings. This information shall be obtained from the status values of (111064, DCM, “Summary of Detections”) and (111065, DCM, “Summary of Analyses”).

4.16.4.2.2.1.1.9 Post-Processing of For Presentation Images

5010 This profile does not constrain the ability of the Image Display to further post-process “For Presentation” images, for example with edge enhancement or noise reduction.

However, there shall be a mode in which actual pixels of “For Presentation” images are displayed not only with 1:1 display to encoded pixel size, but with no further processing or interpolation other than application of point grayscale transformations.

4.16.4.2.2.1.1.10 Accidental reading of prior studies

5015 There is a significant risk that during primary interpretation the most recently available prior study on the Image Display will be interpreted by the user as the current study, if for some reason the current study is not available.

5020 Accordingly, it is required that an Image Display explicitly warn the user if none of the studies being displayed are within a user configurable period from the current real time, as determined by Acquisition Date (0008,0022).

4.16.4.2.2.1.2 Display of Stereotactic Mammography Images

This section intentionally, temporarily left blank.

4.16.4.2.2.1.3 Display of DBT Images

5025 Image Display Actors participating in the Digital Breast Tomosynthesis Profile shall fulfill all requirements listed in Section 4.16.4.2.2.1.1 for the display of Digital Mammography X-Ray Image instances in addition to requirements listed in this section.

5030 In the Digital Breast Tomosynthesis Profile, since current and prior studies may be performed with either conventional 2D mammography or DBT or both, and since DBT images may consist of tomosynthesis reconstructions alone, or generated 2D images or both, the Image Display shall be capable of displaying combinations of screening views (typically left and right CC and MLO) from a current and prior set of a pair of any of the following types of acquisition:

- Tomosynthesis slices
- Tomosynthesis slabs

- Conventional 2D mammography images
 - 5035 • Generated 2D images derived from tomosynthesis data
- I.e., Assuming an eight viewport layout, Image Displays shall be at minimum capable of displaying the following combinations based on the user preferences:
- Up to four views of current and prior study of the same acquisition type (e.g., current and prior DBT slices, or current and prior conventional 2D mammography images).
 - 5040 • Up to four views of current study of one acquisition type compared with the same views of current exam of a different acquisition type (e.g., current conventional 2D mammography images and current DBT slices).
 - Up to four views of current study of one acquisition type compared with the same views of a prior of a different acquisition type (e.g., current DBT slices with prior conventional 2D mammography images).
 - 5045

Furthermore, the user shall be provided with a means to toggle between the available conventional 2D mammography images, tomosynthesis slices, and generated 2D image for the views currently displayed without affecting the display layout.

- 5050 Image Displays shall support calibration as described in the DICOM Grayscale Standard Display Function (GSDF). The minimum and maximum luminance of the display shall be configurable by the site, within the gamut of the device, for the purpose of conforming to local, regional or national regulatory and other requirements for luminance settings throughout the organization. For example, a site may require that all Image Displays used for consultation be calibrated to the same minimum and maximum luminance.

5055 **4.16.4.2.2.1.3.1 Background Air Suppression**

Image Displays shall apply background air suppression to tomosynthesis slices and generated 2D images as defined in Section 4.16.4.2.2.1.1.1.

4.16.4.2.2.1.3.2 Image Orientation and Justification

- 5060 Image Displays shall apply image orientation and justification requirements as described in Section 4.16.4.2.2.1.1.2 to tomosynthesis slices, and generated 2D images.

- 5065 For images encoded with the Breast Tomosynthesis Image IOD, the orientation information is stored within the Image Orientation (Patient) (0020,0037) attribute in the Plane Orientation Sequence (0020,9116) of the Shared Functional Groups Sequence (5200,9229), and consideration of this pair of unit vectors describing the orientation of the image rows and columns with respect to the patient-relative 3D coordinate system is required to determine the orientation of the image, since Patient Orientation (0020,0020) is not present in the Breast Tomosynthesis Image IOD. The Image Display shall not assume that Patient Orientation (0020,0020), if present, is reliable, and shall not assume that the pixels are encoded with any particular or expected orientation.

5070 For images encoded with the Breast Tomosynthesis Image IOD, the Image Display shall use the View Code Sequence (0054,0220), View Modifier Code Sequence (0054,0222) and Frame Laterality (0020,9072) in the Frame Anatomy Sequence (0020,9071) of the Shared Functional Groups Sequence (5200,9229) together with Image Orientation (Patient) (0020,0037) to display images according to the preferred hanging protocol of the current user.

5075 **4.16.4.2.2.1.3.3 Image Size**

The physical size of the pixels in an image encoded with the Breast Tomosynthesis Image IOD for the purposes of image sizing, distance measurements and the display of a distance caliper shall be approximated by using the values of Pixel Spacing (0028,0030) since geometric effects will have been accounted for during reconstruction.

5080 Pixel Spacing (0028,0030) within the Pixel Measures Sequence (0028,9110) may either be part of the Shared Functional Groups Sequence (5200,9229) or the Per-frame Functional Groups Sequence (5200,9230).

4.16.4.2.2.1.3.3.1 Same Size

5085 Image Displays shall be capable of displaying multiple single frame or multi-frame images such that all images are at the same relative physical size, regardless of whether they have the same values of Pixel Spacing (0028,0030) or not.

5090 Further, within a single Breast Tomosynthesis Image instance, the Image Display shall be capable of displaying multiple frames of the image such that all frames are at the same relative physical size, regardless of whether they have the same values of Pixel Spacing (0028,0030) or not.

This means that as the user scrolls through each frame, the encoded pixel data for each frame may need to be interpolated with a different magnification factor than adjacent frames.

5095 The location about which the frame pixel data is interpolated shall be chosen for successive slices such that the displayed image remains centered vertically at the middle of the vertical extent of the viewport and centered horizontally at the chest wall side of the viewport, until/if the user explicitly pans or zooms the displayed image to establish a new extent of pixels to be displayed.

5100 The initial state (magnification factor relative to the physical size of the patient) is at the discretion of the implementer, but since multiple images (different views and prior images) are required to be at the same size, whether or not a particular tomosynthesis slice is used to establish the initial size is not of importance, since the variation in spatial extent (how much of the breast tissue occupies a particular frame or image) is likely to vary more between sides, views and priors than within a set of frames for one image.

5105 For Same Size display of any supported combination of conventional 2D mammography images with tomosynthesis slices and/or generated 2D images, the physical size of the pixels in a conventional 2D mammography image shall be approximated by using the values of Imager Pixel Spacing (0018,1164) divided by Estimated Radiographic Magnification Factor (0018,1114), to account for geometric effects.

4.16.4.2.2.1.3.3.2 True Size

5110 Image Displays shall be capable of displaying multiple single frame or multi-frame images such that all images are true size, regardless of whether they have the same values of Pixel Spacing (0028,0030) or not.

Further, within a single Breast Tomosynthesis Image instance, the Image Display shall be capable of displaying multiple frames of the image such that all frames are at true size, regardless of whether they have the same values of Pixel Spacing (0028,0030) or not.

5115 For True Size display of any supported combination of conventional 2D mammography images with tomosynthesis slices and/or generated 2D images, the physical size of the pixels in a conventional 2D mammography image shall be approximated by using the values of Imager Pixel Spacing (0018,1164) divided by Estimated Radiographic Magnification Factor (0018,1114), to account for geometric effects.

4.16.4.2.2.1.3.3.3 View Actual Pixels

For Image Displays, the view actual pixels display as described in Section 4.16.4.2.2.1.1.3.3 shall be applicable during display of any supported combination of conventional 2D mammography images, tomosynthesis slices and generated 2D images.

5125 4.16.4.2.2.1.3.4 Image Contrast Adjustments

For Image Displays, the image contrast adjustment requirements in Section 4.16.4.2.2.1.1.4 shall be applied during the display of any combination of conventional 2D mammography images, tomosynthesis slices and generated 2D images.

5130 VOI LUT Sequence (0028,3010), Window Center (0028,1050) and Window Width (0028,1051) within the Frame VOI LUT Sequence (0028,9132) may either be part of the Shared Functional Groups Sequence (5200,9229) or the Per-frame Functional Groups Sequence (5200,9230).

4.16.4.2.2.1.3.5 Annotation of Image Information

5135 For Image Displays the annotation requirements in Section 4.16.4.2.2.1.1.5 and all its sub-sections shall be applied during the display of any combination of conventional 2D mammography images, tomosynthesis slices, and generated 2D images except that, for images encoded with the Breast Tomosynthesis Image IOD the chest wall determination shall be based on Image Orientation (Patient) (0020,0037) in the Plane Orientation Sequence (0020,9116) of the Shared Functional Groups Sequence (5200,9229) rather than Patient Orientation (0020,0020) to avoid covering of breast tissue with annotations.

5140 4.16.4.2.2.1.3.5.1 Annotation of Identification Information

Image Displays shall fulfill the requirements defined in Section 4.16.4.2.2.1.1.5.1 for the attributes listed in Table 4.16.4.2.2.1.3.5.1-1.

Table 4.16.4.2.2.1.3.5.1-1: Identification Attributes for Display

Attribute	Tag	Requirement
Patient's Name	(0010,0010)	Clinical
Patient ID	(0010,0020)	Clinical
Patient's Birth Date	(0010,0030)	Clinical
Patient's Age	(0010,1010)	Clinical
Operators' Name	(0008,1070)	Clinical
Manufacturer	(0008,0070)	Investigative
Institution Name	(0008,0080)	Clinical
Institution Address	(0008,0081)	Investigative
Manufacturer's Model Name	(0008,1090)	Investigative
Device Serial Number	(0018,1000)	Investigative
Software Versions	(0018,1020)	Investigative
Station Name	(0008,1010)	Clinical
Contributing Sources Sequence	(0018,9506)	
>Acquisition DateTime	(0008,002A)	Clinical
>Detector ID	(0018,700A)	Investigative
>Date of Last Detector Calibration	(0018,700C)	Investigative

5145

4.16.4.2.2.1.3.5.2 Annotation of Technical Factor Information

Image Displays shall fulfill the requirements defined in Section 4.16.4.2.2.1.1.5.2 for the attributes in Table 4.16.4.2.2.1.3.5.2-1:

Table 4.16.4.2.2.1.3.5.2-1: Technique Attributes for Display

Attribute	Tag	Notes
X-Ray 3D Acquisition Sequence	(0018,9507)	
>KVP	(0018,0060)	
>Exposure in mAs	(0018,9332)	
>Exposure Time in ms	(0018,9428)	
>Filter Material	(0018,7050)	
>Anode Target Material	(0018,1191)	
>Compression Force	(0018,11A2)	
>Body Part Thickness	(0018,11A0)	
>Primary Positioner Scan Start Angle	(0018,9510)	Used to derive the angle of the center of the arc.
>Primary Positioner Scan Arc	(0018,9508)	For additional information on angles see also DICOM CP

Attribute	Tag	Notes
		1282 (final text).
>Entrance Dose in mGy	(0040,8302)	
>Organ Dose	(0040,0316)	
Image Type	(0008,0008)	Used to display a human readable value of Value 4 for a derived image, e.g., if Value 4 is GENERATED_2D, a string such as "Generated 2D" might be displayed.
X-Ray 3D Reconstruction Sequence	(0018,9530)	
>Reconstruction Description	(0018,9531)	

5150

4.16.4.2.2.1.3.5.3 Annotation of View Information

Image Displays shall provide a mechanism to annotate view information as described in Section 4.16.4.2.2.1.1.5.3, except that the orientation information shall be obtained from Image Orientation (Patient) (0020, 0037), see Section 4.16.4.2.2.1.3.2 Image Orientation and Justification.

5155

For images encoded using the Breast Tomosynthesis Image IOD the Image Display shall derive the abbreviations displayed in the viewport from View Code Sequence (0054,0220), View Modifier Code Sequence (0054,0222) and Frame Laterality (0020,9072) in the Frame Anatomy Sequence (0020,9071) of the Shared Functional Groups Sequence (5200,9229).

5160

4.16.4.2.2.1.3.5.4 Annotation of Frame Information

Image Displays shall fulfill the following annotation requirements:

- Frames shall be numbered from 1 to Number of Frames (0028,0008) corresponding to the encoded order of the Frames in Pixel Data (7FE0,0010). For each frame the annotation shall show the current frame number and the number of frames.
- For tomosynthesis frames, the thickness in mm of the frame based on the Slice Thickness (0018,0050) within Pixel Measures Sequence (0028,9110) of the Shared Functional Groups Sequence (5200,9229) or Per-frame Functional Groups Sequence (5200,9230) shall be displayed.
- For tomosynthesis frames the position within the stack of frames shall be displayed. The position shall be computed from the Image Position (Patient) (0020,0032) distance along the normal to the Image Orientation (Patient) (0020,0037) with an indication of the patient-relative direction along that normal (e.g., lateral to medial, head to foot).

5165

5170

4.16.4.2.2.1.3.6 Annotation of Size Information

5175 For the purpose of this section, physical pixel size is as defined in Section 4.16.4.2.2.1.3.3. Image Displays shall fulfill requirements defined in Section 4.16.4.2.2.1.1.6.

Note: For tomosynthesis frames, the reported distance measured will be based on actual size within the patient estimated during the reconstruction process, and may not be directly comparable with size measured from conventional 2D mammography images or generated 2D images.

4.16.4.2.2.1.3.7 Partial View Option

5180 Image Displays supporting the Partial View Option in the Digital Breast Tomosynthesis Profile shall fulfill all requirements listed in Section 4.16.4.2.2.1.1 for tomosynthesis slices, and generated 2D images.

4.16.4.2.2.1.3.8 Accidental Reading of Prior Studies

5185 Requirements defined in Section 4.16.4.2.2.1.1.10 shall apply to Image Displays in the Digital Breast Tomosynthesis Profile as well. The Acquisition DateTime (0008,002A) attribute in the Contributing Sources Sequence (0018,9506) (see Table 4.8.4.1.2.7-3) shall be used to determine the display of a warning message, if no studies are within a configurable period from the current real time.

4.16.4.2.2.1.3.9 Scrolling through Multi-frame Tomosynthesis Images

5190 Image Displays shall be able to present tomosynthesis images in the viewport as a similar conventional 2D mammography view might be displayed. The tomosynthesis images are multi-frame. Accordingly, the user shall be provided with a means to scroll through the frames (such as one might scroll through a set of CT or MR slices).

5195 Two modes of scrolling, manual and automatic (cine), shall be provided. For the automatic mode, the user shall be provided with control over the cine speed (frame rate) and the initial speed shall be configurable.

5200 Note: It is recommended that the maximum speed of scrolling be rapid so as to take advantage of the human visual system's sensitivity to motion in order to detect subtle abnormalities. It is beyond the scope of this transaction to specify a hardware performance target, but a maximum scrolling rate of at least 25 frames per second for an entire 5 MP display is desirable.

The user shall have control over the cine playback sequencing such that they may choose looping, sweeping or stopping (see definitions in DICOM PS 3.3 Preferred Playback Sequencing (0018,1244), even though this attribute is not used).

The Image Display shall not skip slices during manual or automatic scrolling.

5205 Note: I.e., if the Image Display is unable to keep up with the user's requested frame rate, then the display will show all slices rather than scrolling faster.

Scrolling between tomosynthesis frames shall be available regardless of the arrangement of the display and the combination with other views, whether the other views are tomosynthesis slices, conventional 2D mammography images or generated 2D images.

5210 Scrolling shall be in spatial sequence according to Image Position (Patient) (0020,0032).

Scrolling shall be controllable using both a pointing device and the keyboard.

Vertical movement of a conventional pointing device (such as a mouse) upward shall scroll toward the paddle (i.e., away from the detector). Touch screen pointing devices should scroll in the opposite direction.

5215 **4.16.4.2.2.1.3.10 For Presentation Breast Projection X-Ray Images Option**

This section intentionally, temporarily left blank.

4.16.4.2.2.1.3.11 Display of DBT Images by the Viewer on the Media (Media Creation Option)

5220 The Media Creation Option of the Digital Breast Tomosynthesis (DBT) Profile groups an Acquisition Modality or Image Display with a Portable Media Creator in the Portable Data for Imaging (PDI) Profile, and allows for a viewer to be recorded on the media. That viewer is considered an Image Display for the purposes of this section and, the contents of this section are required for all such viewers recorded on media by actors claiming the Media Creation Option of the Digital Breast Tomosynthesis (DBT) Profile.

5225 The Image Display shall be capable of displaying all SOP instances recorded on the media that are of the SOP Classes specified in Section 4.16.4.1.3.7. In addition, the Key Object Selection Document Storage SOP Class and Grayscale Softcopy Presentation State Storage SOP Class shall be supported if such instances are present on the media.

5230 The Media Creation Option of the Digital Breast Tomosynthesis (DBT) Profile defines a simplified set of functions for the Image Display to make available to the user with the intent of being able to perform basic review of individual or pairs of images encoded in any of the SOP Classes supported by the Digital Breast Tomosynthesis (DBT) Profile, as well as Key Image Notes and annotations, grayscale contrast and spatial transformations in Presentation States. Additional features may be present.

5235 The Image Display shall provide a means of selecting a single patient to display when more than one patient's studies are recorded on the media. When only a single patient is recorded, there is no need for a patient selection mechanism.

The Image Display shall provide some means of selecting which images to display.

5240 The Image Display shall allow at least two images of any of the supported SOP Classes for the same or different studies to be compared side by side in separate viewports (to allow for comparison of different images of the current or prior studies). The Image Display shall allow display of only a single image in a single viewport (in order to take advantage of limited screen space).

5245 The Image Display shall fulfill all requirements listed in Section 4.16.4.2.2.1.1 related to the application of window/level and VOI LUTs present in the images and any Presentation States present on the media. Contrast adjustments as described in Section 4.16.4.2.2.1.3.4 shall be supported.

Background air suppression as defined in Section 4.16.4.2.2.1.3.1 shall be supported.

5250 Image Displays shall apply image orientation and justification requirements as described in Section 4.16.4.2.2.1.3.2.

The physical size of pixels for the purpose of annotations and measurements shall be obtained as described in Sections 4.16.4.2.2.1.3.3 and 4.16.4.2.2.1.1.3.

5255 There is no requirement for Same Size, True Size or View Actual Pixels display, but the Image Display shall provide continuous (not stepped) zooming and panning of an image displayed in a viewport.

The Image Display shall provide scrolling through multi-frame images as described in Section 4.16.4.2.2.1.3.9, except that only manual, not automatic, scrolling is required.

5260 The Image Display shall provide annotation of the displayed images as described in Section 4.16.4.2.2.1.3.5 and its subsections, and annotation of size information as described in Section 4.16.4.2.2.1.3.6.

There is no requirement for specific behavior for partial view images.

The Image Display shall provide a tool to measure distance in a straight line between two user-defined points. There is no requirement to be able to save such measurements.

5265 The Image Display shall provide the user with the ability to select Key Images if Key Image Notes are present on the media, as defined in the Key Image Note Profile.

5270 The Image Display shall provide the user with the ability to select and apply Presentation States if Grayscale Softcopy Presentation State Storage instances are present on the media, as defined in the Consistent Presentation of Images (CPI) Profile, except that calibration of the display to the GSDF is not required since the Portable Media Creator that records the Image Display on the media has no control over the viewing environment in which the Image Display will be used.

4.16.4.2.2.2 Display of Localizer Lines

Image Display or Imaging Document Consumer Actors that want to show the localizer lines, if visible, will be able to calculate the position of these lines of intersection based on the information recorded in the images by the Acquisition Modality (See Section 4.8.4.1.2.1).

5275 4.16.4.2.2.3 Display of NM Images

The contents of this section are required for Image Displays claiming the NM Image Profile.

The following requirements are intended to establish a baseline level of capabilities. Providing more intelligent and advanced capabilities is both allowed and encouraged. The intention is to focus on display capabilities, not to dictate implementation details.

5280 Note that the NM Image Profile is undergoing revision, and vendors considering implementation are advised to include the modifications contained in the trial implementation version “NM Image Profile with Cardiac Option”. For additional information please contact the IHE Radiology Technical Committee at IHE-Rad-Tech@googlegroups.com.

Some examples of display behaviors typical to NM are described in RAD TF-1, Appendix E.5.3.

- 5285 The NM Image IOD is a multi-frame image indexed by vectors as described in Section 4.8.4.1.2.2.1. “Image” will be used here to strictly refer to the IOD, while frame will be used to refer to the usual two-dimensional array of pixels.
- The Image Display shall be able to display the frames in the order they are stored in the image.
- 5290 The Image Display shall be able to perform the frame selections shown for each Image Type in the Table 4.16-1 and as described below in Section 4.16.4.2.2.3.1 Frame Selection Support. The result of a frame selection will be referred to as a “frameset” in this document. Note that a frameset only references frames from a single Image.
- The Image Display shall be able to display simultaneously multiple framesets. These may be from the same Image, different Images, different Series, or different Studies.
- 5295 The Image Display is not required to display simultaneously multiple framesets with different Image Types. (Note that two exceptions to this are identified in Section 4.16.4.2.2.3.5 Review Option).
- The Image Display shall be able to display simultaneously at least the number of framesets indicated in Table 4.16-1.
- 5300 All frames in the displayed frameset(s) are not required to be on the screen at once; if there are more frames than fit on the screen based on the current frame display size (see Section 4.16.4.2.2.3.4 Image Zoom), the ability to scroll through the frames is required.
- The Image Display shall be able to display, if present, the View Code Sequence (0054,0220), Acquisition Context Sequence (0040,0555), Series Description (0008,103E) and Acquisition Time (0008,0032) values for a given frameset.
- 5305 The Image Display is required to support the display capabilities for each Image Type shown in Table 4.16-1.

Table 4.16-1: Selection, Sorting and Viewing Requirements for NM Images

Image Type (0008,0008) Value 3	Frame Increment Pointer (0028,0009) [i.e., vectors]	Required Frame Selection ¹ E = single <u>E</u> = all	Display Capabilities (See 4.16.4.2.2.3.2)	# of Simultaneous Framesets	
				Basic	Review Option
STATIC	Energy Window (0054,0010) Detector (0054,0020)	<u>E D</u> E <u>D</u> <u>E D</u> *	Grid Display	1	1
			Fit Display	12	12
			Cine	-	1 (optional)
WHOLE BODY	Energy Window(0054,0010) Detector(0054,0020)	<u>E D</u> E <u>D</u> <u>E D</u> *	Whole body Display	2	4 ²
DYNAMIC	Energy Window (0054,0010)	<u>E D P T</u> E D P <u>T</u>	Grid Display	1	1
			Comparison Display	1	2

Image Type (0008,0008) Value 3	Frame Increment Pointer (0028,0009) [i.e., vectors]	Required Frame Selection ¹ E = single <u>E</u> = all	Display Capabilities (See 4.16.4.2.2.3.2)	# of Simultaneous Framesets	
				Basic	Review Option
	Detector (0054,0020) Phase (0054,0100) Time Slice (0054,0030)	<u>E</u> <u>D</u> <u>P</u> <u>T</u>	Cine	1	2
GATED	Energy Window (0054,0010) Detector (0054,0020) R-R Interval (0054,0060) Time Slot(0054,0070)	<u>E</u> <u>D</u> <u>I</u> <u>T</u>	Grid Display	1	1
			Comparison Display	3	6
			Cine	3	6
TOMO	Energy Window (0054,0010) Detector (0054,0020) Rotation (0054,0050) Angular View (0054,0090)	<u>E</u> <u>D</u> <u>R</u> <u>A</u>	Grid Display	1	1
			Comparison Display	3	3
			Cine	3	3
GATED TOMO	Energy Window(0054,0010) Detector (0054,0020) Rotation (0054,0050) R-R Interval (0054,0060) Time Slot (0054,0070) Angular View (0054,0090)	<u>E</u> <u>D</u> <u>R</u> <u>I</u> <u>T</u> <u>A</u> <u>E</u> <u>D</u> <u>R</u> <u>I</u> <u>T</u> <u>A</u> <u>E</u> <u>D</u> <u>R</u> <u>I</u> <u>T</u> <u>A</u> - any one of above three	Grid Display	1	1
			Cine	1	1
RECON TOMO	Slice(0054,0080)	<u>S</u>	Grid Display	1	1
			Comparison Display	3	6
			Cine	3	3
			MPR Display	-	1
GATED RECON TOMO	R-R Interval (0054,0060) Time Slot(0054,0070) Slice (0054,0080)	<u>I</u> <u>T</u> <u>S</u> <u>I</u> <u>T</u> <u>S</u> <u>I</u> <u>T</u> <u>S</u> *	Grid Display	1	1
			Comparison Display	1	2
			Cine	-	2
			MPR Display	-	1

5310

Note 1: The Frame Selection column refers to the Frame Increment Pointer vectors by their first letter (except for R-R Interval which uses “I” for Interval). A letter shown underlined and bold (e.g., E) indicates that all values for that vector are selected. A letter shown in plain text (e.g., E) indicates that a single value for that vector has been selected. So in the case of the TOMO Image Type, E R D A means that all frames of the image are selected; while E R D A means that the selected frames represent all Angular Views for a specific Energy Window, a specific Detector and a specific Rotation. An asterisk (*) indicates that it is required under the review option only, and not required under the basic NM Image Profile.

5315

Note 2: The requirement for 4 framesets is to handle the case where the 4 frames are in separate framesets due to the anterior and posterior views being in separate images. It is not required to support 4 framesets with 2 frames each.

4.16.4.2.2.3.1 Frame Selection Support

5320

A Frame Selection consists of either a single value, or “all values” being identified for each vector in the Image. In fact (except for the case of selecting “all frames” and the case of selecting

all phases and time slices in a Dynamic Image) a single value will be identified for all but one of the available vectors.

5325 It is not necessary to require the user to specify a value for single valued vectors, such as when, for example, only a single detector value is present. It is desirable for the application to provide a way to make a selection when a vector that is *typically* single valued unexpectedly has additional values.

5330 When selecting values for certain vectors, the user shall be presented with meaningful terms, if available, rather than the underlying integer values from the DICOM vector. For example, in the case of the detector vector, if the View Code Sequence it present, the terms contained there (e.g., “Anterior”, “Posterior”) shall be used instead of the Detector Number from the vector.

The sources of selection terms in priority order (i.e., the first, if present shall be used, otherwise consider the next) are shown in the following table:

Table 4.16-2: Sources of Value Selection Terms for Vectors

Vector	Source of Selection Terms
Energy Window	1. Energy Window Name (0054,0018) 2. Energy Window Lower Limit (0054,0014) & Energy Window Upper Limit (0054,0015) 3. Energy Window Number
Detector	1. View Code Sequence (0054,0220) 2. Detector Number
Phase	1. Phase Description (0054,0039) 2. Phase Number
Rotation	1. Rotation Number
R-R Interval	1. R-R Interval Number
Time Slot	1. Time Slot Number
Angular View	1. Angular View Number
Slice	1. Slice Number

5335 One method of allowing the user to select a frameset by vectors might be to display a multi-vectored image to the user as if it were broken down into its components by vector. For example, a 2-phase dual-detector GI bleed study might be shown to the user as

GI-bleed Phase-1 Anterior

GI-bleed Phase-1 Posterior

GI-bleed Phase-2 Anterior

5340 GI-bleed Phase-2 Posterior

This is acceptable as a means of frame selection support, provided the user has the option of selecting all the parts of the image for display as at the same time, should the user desire to do so, and provided that the multi-vectored image remains as a single image if it is sent via DICOM to another system.

5345 **4.16.4.2.2.3.2 Display Capabilities**

Image Displays are required to support the following display formats as indicated above in Table 4.16-1

5350 Practical examples of the usage and appearance of these display capabilities can be found in RAD TF-1: Appendix E.5 NM Display and in particular in RAD TF-1: Appendix E.5.3 NM Display Examples.

4.16.4.2.2.3.2.1 Grid Display

For Grid Display, the Image Display shall display a single frameset arranged in a 2D grid of frames.

4.16.4.2.2.3.2.2 Fit Display

5355 For Fit Display, the Image Display shall display several framesets simultaneously. Efficient use of screen space is encouraged. The Image Display is free to organize the frames any way that seems sensible. In the absence of other useful information, it is common to display them in order of acquisition time.

4.16.4.2.2.3.2.3 Comparison Display

5360 For Comparison Display, the Image Display shall display several framesets simultaneously in a fashion such that frames in the two framesets can be compared. For example, each frameset could be placed on an adjacent row.

Display of each frameset in a single row (i.e., the number of rows equals the number of framesets) is required. Support for more than one row per frameset is optional.

5365 Comparison requires that the relationship between frames in the two framesets be maintained when navigating, and to be adjusted separately/established.

4.16.4.2.2.3.2.4 Whole Body Display

For Whole Body Display, the Image Display shall simultaneously display of both the anterior and posterior frames of an NM whole body image.

5370 These images will typically be rectangular in shape (taller than wide) and are typically 256 x 1024 or 512 x 1024 in size. The display system should display them as rectangular frames (and not pad them to make them square).

4.16.4.2.2.3.2.5 MPR (Multi-Planar Reconstruction) Display

5375 For MPR Display, the Image Display shall provide MPR capabilities for slice stack data. Typically, MPR involves displaying three orthogonal plane views at the same time along with a method of navigating the volume (i.e., controlling the specific sagittal, coronal and transaxial images shown).

The Image Display is not required to generate oblique slices from slice data, but is required to generate orthogonal slices even if the slice data is obliquely oriented.

5380 In the NM Image Profile, MPR Display shall be supported when claiming the Review Option (See Section 4.16.4.2.2.3.5). When displaying NM Data, the Image Display shall be specifically capable of taking a frameset of slice data from a RECON TOMO or GATED RECON TOMO image and displaying all three orthogonal plane views (transaxial, saggital and coronal). PET transaxial data in the MPR display is strongly encouraged, but not required under the NM Profile.

5385

Refer to DICOM documentation for details on how orientation and spatial information is encoded in the NM Image IOD.

4.16.4.2.2.3.2.6 Cine Display

5390 The Image Display shall be able to display a cine of the selected frames as indicated by the order they are stored in the Image.

The Image Display shall be capable of displaying cines of multiple framesets simultaneously as indicated above in Table 4.16-1.

5395

When the framesets have the same number of frames, the Image Display shall be capable of displaying the cines in synchronization (i.e., the first frame of each frameset should display simultaneously, the second frame of each frameset should display simultaneously, etc.).

The Image Display shall provide the ability to adjust intensity (as described below in Section 4.16.4.2.2.3.3) for each frameset independently. The ability to adjust intensity while a cine is running is useful but not required.

4.16.4.2.2.3.3 Intensity and Color

5400 NM clinical practice requires the ability to adjust the Upper and Lower Window Levels rather than the Window Center and Window Width. Refer to RAD TF-1: Appendix E.5.1 for details on NM usage of intensity and color attributes.

5405

For all images with a modality type of NM, the Image Display shall provide direct control over the Upper Window Level and the Lower Window Level display parameters independently from each other for both grayscale and pseudocolor display.

This control shall be available for all frames as a group and for each frameset individually. Optionally is it also useful to support adjustment of individual frames.

Window Level values shall be translated into equivalent Window Width and Center values when stored in the image attributes.

5410

The Image Display shall be capable of effectively “inverting” the image (in the sense of switching between a MONOCHROME1 and MONOCHROME2 interpretation). The method is undefined. This requirement applies to grayscale image display only; it is not required for pseudo-color lookup tables.

If the Image Display supports a color screen, the following shall be supported:

5415

The Image Display shall support display of frames of grayscale Images using a pseudo-color lookup table.

The Image Display shall allow the user to select from a configured set of pseudo-color lookup tables. Simultaneous display of both grayscale and pseudo-color presentations is not required. Thus, selecting a color lookup table may change all displayed frames on the screen.

5420 The Image Display shall provide a method of adding new pseudo-color lookup tables. It is acceptable if this is only available to service engineers.

4.16.4.2.2.3.4 Image Zoom

5425 The Image Display shall be capable of “zooming” the frames where zooming consists of resampling and displaying the frame at a larger or smaller matrix size. For example re-sampling a 128x128 frame to create a 256x256 frame is referred to as a 2X zoom in this document.

All zooming of NM images shall preserve the aspect ratio (that is, the same zoom factor shall be applied in both the x and y dimensions). The Image Display is free to use pixel replication or interpolation to perform image zooming.

5430 Some guidelines on appropriate default display sizes and desirable zoom behaviors are provided in RAD TF-1: Appendix E.5.2 NM Image Resizing.

4.16.4.2.2.3.5 Review Option

Image Displays claiming the Review Option shall support the following display capabilities and those indicated in Table 4.16-1.

5435 The Image Display shall be capable of displaying both a Dynamic Image frameset and Static Image frameset(s) at the same time.

The Image Display shall be capable of displaying both a Whole body Image frameset and a Static Image frameset at the same time (i.e., anterior & posterior whole body and several static spot images).

The Image Display shall be capable of displaying the pixel value of a selected pixel.

5440 4.16.4.2.2.4 Display of Result Screens

The contents of this section are required for Image Displays claiming the NM Image Profile. Refer to Table 4.18-2 for the specific SOP Class UIDs of the IODs referenced here for use as Result Screens.

5445 The Image Display shall be able to display DICOM Secondary Capture images (including specifically 8 and 16 bit monochrome and 24 bit RGB).

The Image Display shall be able to display DICOM Multi-Frame Secondary Capture images (including specifically 8-bit monochrome and 24-bit True Color)

5450 The Image Display shall be able to display result screens at their original pixel resolution. If the display size is equal to or greater than the size of the result screen, this should be done as the default. If the display size is less than the size of the result screen, this will require some sort of panning capability.

The Image Display shall be able to scale result screens using a fixed aspect ratio. If the display size is smaller than the size of the result screen, this should be done to fit the result screen onto the display as the default.

- 5455 For Multi-Frame Secondary Capture images which contain a Cine module, the Image Display shall be able to cine the frames. The default cine rate shall be the value in the Cine module, or the maximum rate of the Image Display, whichever is slower.

4.16.4.2.3 Expected Actions

The Image Display or Imaging Document Consumer presents to the user a DICOM Image.

- 5460 The Image Display or Imaging Document Consumer may receive patient data inconsistent with those received from a previously issued query or retrieve operation. For example, in the event that a patient has been renamed, the Image Display or Imaging Document Consumer will receive images with the same Study Instance UID, Series Instance UID and SOP Instance UIDs, but with a different patient name. The Image Display or Imaging Document Consumer shall use the just queried information or the most recently received instances to ensure that the most recent patient data from the Image Manger/Archive or Imaging Document Source is displayed.
- 5465

The Image Display or Imaging Document Consumer shall be able to display the Series Description for each series displayed.

4.16.4.2.3.1 NM Image Specifics

- 5470 Actors claiming the NM Image Profile which have applications that accept re-sliced (reconstructed tomographic) cardiac data for viewing or further processing shall make use of the View Code Sequence (0054,0220), Slice Progression Direction (0054,0500) and Acquisition Context Sequence (0040,0555) attributes to aid in the selection of input data. However, the means by which these attributes are used to identify and/or process the data is unspecified.

- 5475 Note: a means for identifying and processing cardiac input data that does not include the above mentioned attributes will likely be useful due to the existence of Images without those attributes. Series Description may be useful in such cases.

- 5480 Matching related studies or series (such as stress and rest images) is an important part of NM processing and display. When Image Displays are trying to do this they shall look for the Patient State (0038,0500) to identify such things as stress and rest images and in the NM Acquisition Context Module, the Image Orientation in the Detector Sequence, and the View Code Sequence (0054,0220) to identify images with desired orientations. Since images may exist without those fields present, the Series Description may also be examined for relevant details by the software.

5485

4.17 Retrieve Presentation States [RAD-17]

This section corresponds to Transaction RAD-17 of the IHE Technical Framework. Transaction RAD-17 is used by the Image Display or Imaging Document Consumer to request and retrieve Presentation State from the Image Archive or Imaging Document Source.

5490 4.17.1 Scope

This section describes the sequence of messages required for the Image Display or Imaging Document Consumer to retrieve Grayscale Softcopy Presentation State Instances from the Image Archive or Imaging Document Source. The Image Display or Imaging Document Consumer will query and then retrieve Presentation State objects. The transformations will be applied by the Image Display or Imaging Document Consumer to the image data to assure the image display is consistent with the device that originally created and stored the Presentation State. The Image Display or Imaging Document Consumer will be required to support all transformations defined in DICOM PS 3.4: Grayscale Softcopy Presentation State Storage. In addition, multiple Presentation States may exist that reference the same image data.

5500 4.17.2 Use Case Roles

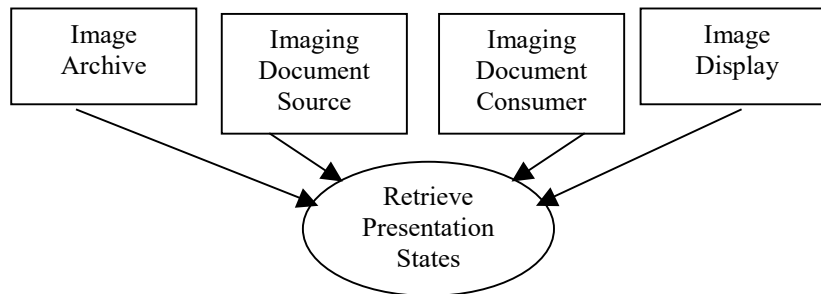

Actor: Image Display

Role: Retrieve Grayscale Softcopy Presentation State objects together with the referenced image data and apply the transformations specified by the Presentation State. This device will implement the Query/Retrieve SOP Classes in the role of an SCU.

Actor: Imaging Document Consumer

Role: Retrieve Grayscale Softcopy Presentation State objects together with the referenced image data and apply the transformations specified by the Presentation State. This actor must support pixel rendering according to the Grayscale Standard Display Function (GSDF) defined in DICOM PS 3.14. This device will implement the Query/Retrieve SOP Classes in the role of an SCU.

Actor: Image Archive

Role: Respond to retrieve requests from the Image Display for Grayscale Softcopy Presentation States objects. Transmit requested Grayscale Softcopy Presentation State object(s) to the Image Display. This device will implement the Query/Retrieve SOP Classes in the role of an SCP.

Actor: Imaging Document Source

Role: Respond to retrieve requests from the Imaging Document Consumer for Grayscale Softcopy Presentation States objects. Transmit requested Grayscale Softcopy Presentation State object(s) to the Imaging Document Consumer. This device will implement the Query/Retrieve SOP Classes in the role of an SCP.

5520

4.17.3 Referenced Standards

DICOM PS 3.4: Query/Retrieve Service Class

DICOM PS 3.14: Grayscale Standard Display Function

DICOM PS 3.4: Grayscale Softcopy Presentation State Storage

5525

4.17.4 Interaction Diagram

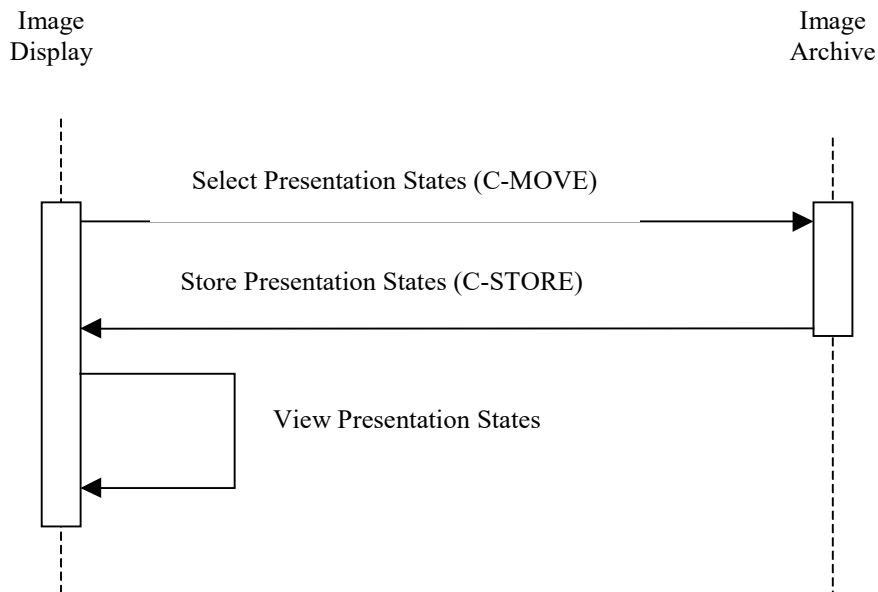

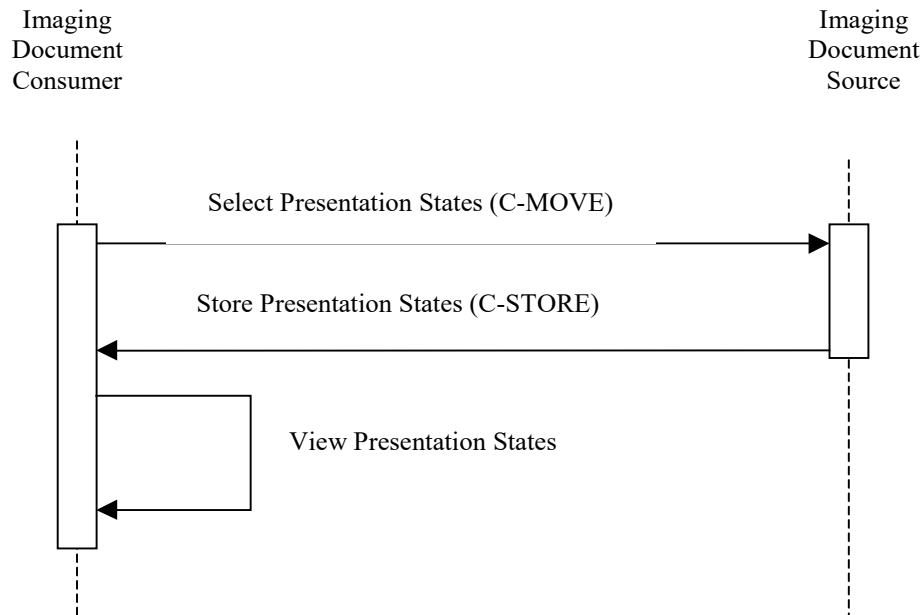

4.17.4.1 Retrieve Grayscale Softcopy Presentation State

5530 This transaction refers to the “C-MOVE” and “C-STORE” messages between the Image Display and Image Archive or Imaging Document Consumer and Imaging Document Source in the above interaction diagram. The Retrieve (Study Root – MOVE and optionally Patient Root – MOVE) SOP Classes are supported. Refer to the DICOM PS 3.4 for detailed descriptive semantics.

5535 In the case of retrieving Grayscale Softcopy Presentation State in a Cross-Enterprise, imaging document sharing (XDS-I) network environment, a configuration of mapping the AE Titles to DICOM AE Network Addresses (IP Address and Port number) are needed to be exchanged between the Imaging Document Source and the Imaging Document Consumer. RAD TF-3: Appendix G describes in details the AE Title mapping to the DICOM AE Network Addresses.

4.17.4.1.1 Trigger Events

5540 The Image Display or Imaging Document Consumer selects specific Grayscale Softcopy Presentation State objects to retrieve from the Image Archive.

4.17.4.1.2 Message Semantics

5545 The message semantics are defined in the DICOM Query/Retrieve Service Class section of the DICOM PS 3.4: Query/Retrieve Service Class. It is the responsibility of the Image Manager or Imaging Document Source to assure that the patient and procedure information is current in the images and Softcopy Presentation State objects when they are retrieved from the Image Archive or Imaging Document Source.

4.17.4.1.3 Expected Actions

5550 The Image Archive or Imaging Document Source receives the C-MOVE request, establishes a DICOM association with the Image Display or Imaging Document Consumer, respectively, and uses the DICOM Grayscale Softcopy Presentation State Storage SOP Class to transfer the requested Presentation State objects.

4.17.4.2 View Presentation States

5555 This transaction relates to the “View Presentation States” event in the above interaction diagram. Presentation States cannot be viewed separately, but must be applied to an image. Refer to Section 4.16 for a description of the transaction used to retrieve images to which Presentation States may be applied.

4.17.4.2.1 Trigger Events

5560 The Image Display or Imaging Document Consumer receives Presentation State instances from the Image Archive or Imaging Document Source respectively.

4.17.4.2.2 Invocation Semantics

5565 This is a local invocation of functions resident within the Image Display or Imaging Document Consumer. The method used by the Image Display or Imaging Document Consumer to present images for viewing by the user after the Presentation State transformations have been applied is outside the scope of the IHE Technical Framework.

4.17.4.2.3 Expected Actions

5570 The Image Display or Imaging Document Consumer applies the transferred Grayscale Softcopy Presentation State to image data and renders it for viewing. The Image Display shall support pixel rendering according to the Grayscale Standard Display Function (GSDF) defined in DICOM PS 3.14. The Image Display or Imaging Document Consumer may receive patient data inconsistent with those received from a previously issued query or retrieve operation. For example, in the event that a patient has been renamed, the Image Display or Imaging Document Consumer will receive Softcopy Presentation State objects with the same Study Instance UID, Series Instance UID and SOP Instance UIDs, but with a different patient name. The Image
5575 Display or Imaging Document Consumer shall use the just queried information or the most recently received instances to ensure that the most recent patient data from the Image Manger/Archive or Imaging Document Source is displayed. If the number of frames (0028,0008) attribute is set to 1, then the Reference Frame Number (0008,1160) shall be ignored.

5580

4.18 Creator Images Stored [RAD-18]

This section corresponds to Transaction RAD-18 of the IHE Technical Framework. Transaction RAD-18 is used by the Image Archive and Evidence Creator Actors.

4.18.1 Scope

5585 In the Creator Images Stored transaction, the Evidence Creator sends the newly generated images for a study to the Image Archive.

4.18.2 Use Case Roles

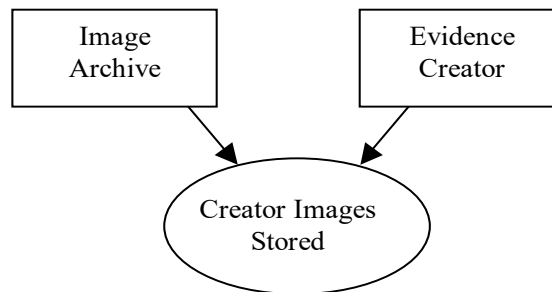

Actor: Evidence Creator

5590 **Role:** Transmit generated image data to Image Archive.

Actor: Image Archive

Role: Accept and store images from Evidence Creators.

4.18.3 Referenced Standards

DICOM PS 3.4: Storage Service Class.

5595 **4.18.4 Interaction Diagram**



4.18.4.1 Images Stored

4.18.4.1.1 Trigger Events

5600 The Evidence Creator transfers images to the Image Archive sequentially within one or more DICOM associations, as the images become available or collectively.

Details about when it is appropriate to trigger the creation of a new Study/Series/Image Instance are described in Section 4.8.4.1.1.1 “Study UIDs and Series UIDs”.

4.18.4.1.2 Message Semantics

5605 The Evidence Creator uses the DICOM C-STORE message to transfer the images. The Evidence Creator is the DICOM Storage SCU and the Image Archive is the DICOM Storage SCP.

Per the DICOM Standard, the Evidence Creator shall create a new series for its created images and not extend series containing source images.

The Evidence Creator derives images from source images, and the derived images may or may not have the same Image SOP Class as the source images.

5610 The source images may include Performed Procedure Step relationship information. This information will include Scheduled Procedure Step information for the procedure performed at an Acquisition Modality. When present in the source images, the Evidence Creator shall extract appropriate Scheduled Procedure Step information and include it with PPS information produced by the Evidence Creator.

5615 See Appendix A for rules on how to use the source image information in the derived image objects.

4.18.4.1.2.1 Storage of Localizer Images (MR and CT)

5620 In addition to these general mapping requirements, in MR and CT images, the relationship
exists. In such a case the attribute Referenced Image Sequence (0008,1140) of the axial image
shall refer to the related localizer or plan image(s). The coordinate space for the set of related
images shall be the same, which is indicated by having a single value for the attribute Frame of
Reference UID (0020,0052). For CT images the axial images shall have the value AXIAL in the
5625 attribute Image Type, and the localizer image the value LOCALIZER. For MR images no
specific value for image type is used to further qualify the relationship between plan and axial
images. If the Evidence Creator wants to show the location of the axial images on the localizer or
plan image, a Presentation State object may be created for this purpose.

4.18.4.1.2.2 Storage of NM Images (NM)

5630 Systems supporting the NM Image Profile must support the requirements described in the
Modality Images Stored transaction Section 4.8.4.1.2.2 Storage of NM Images and Section
4.8.4.1.2.2.1 NM Image IOD: Multi-Frames & Vectors.

An Image Creator that processes cardiac tomographic images (Image Type RECON TOMO or
RECON GATED TOMO) and creates new cardiac tomographic images shall copy the
Acquisition Context Sequence (0040,0555) and its contents into the created images.

4.18.4.1.2.3 Storage of Cardiac Images (NM)

5635 Evidence Creators, Acquisition Modalities or Image Displays creating reconstructed
tomographic datasets shall incorporate Image Orientation [Patient] (0020,0037) (inside the
Detector Information Sequence (0054,0022)), and Spacing Between Slices (0018,0088).

5640 In addition, Evidence Creators creating a reconstructed tomographic dataset representing
standard cardiac views (e.g., Short Axis) shall include the View Code Sequence (0054,0220),
Slice Progression Direction (0054,0500), and Acquisition Context Sequence (0040,0555)
attributes, as appropriate.

These requirements are defined in Section 4.8.4.1.2.2 Storage of NM Images (NM), Table 4.8-2.

4.18.4.1.2.4 Result Screen Export Option

5645 Evidence Creators claiming support of the Result Screen Export Option shall be capable of
storing Result Screens as described in this section.

Result Screens refer to a presentation of result elements on the display, potentially including
graphics, images and text, typically found on clinical analysis software such as NM cardiac
packages.

5650 This option is intended to provide a way of exporting snapshots of Result Screens as DICOM
objects so they can be viewed elsewhere on generic DICOM display systems. As things like
DICOM SR Templates for various clinical results become available, such coded data formats
provide a more robust solution and should be used in preference to the Result Screen Export

- 5655 Option. This Option is not intended to be used for transferring the clinical data for processing or database purposes.
- This option will refer to result screens which include moving images or graphics, such as a beating heart or rotating image, as Dynamic Result Screens. Result screens which do not include moving components will be referred to as Static Result Screens.
- 5660 Result screens which are completely presented in shades of grey will be referred to as Greyscale Result Screens. Result screens which use color presentation will be referred to as Color Result Screens. Result screens which present images in greyscale and only use small amounts of color for the graphics may optionally be considered Greyscale Result Screens.
- 5665 The Evidence Creator shall be capable of storing result screens it presents as described in this section. Note that if an Evidence Creator does not present Dynamic Result Screens, it is not required to implement the dynamic features described, and if an Evidence Creator does not present Color Result Screens, it is not required to implement the color features described.
- 5670 The Evidence Creator shall use DICOM Secondary Capture (SC) IODs or Multi-Frame Secondary Capture (MFSC) IODs for storing Static Result Screens. The use of MFSC IODs is preferred over the use of simple SC IODs due to the lack of attributes to indicate the content of the image, derivation and source of inputs, and other ambiguities in the SC IODs.
- Static Result Screens may be stored using the DICOM SC Image and a set of Static Result Screens may be stored one at a time in DICOM SC Images, however it is strongly recommended that the DICOM MFSC Image IODs be used both for sets of Static Result Screens and individual Static Result Screens.
- 5675 When multiple Static Result Screens are stored in a DICOM MFSC object, the Cine module shall not be included. The order of the Static frames in the MFSC shall represent the intended display order of the result screens.
- 5680 The Evidence Creator shall use DICOM MFSC IODs for storing Dynamic Result Screens. The cine module shall be included as described in Table 4.18-1. The frames shall be ordered to present a cine of the Dynamic Result Screen. The number of frames is not specified here. If there are several cine regions in the result screen and the length of their cine “cycle” is not the same, it is acceptable if there is a “jump” in the playback when the MFSC cycle loops back to the beginning.
- 5685 The Evidence Creator shall support export of Color Result Screens as 24-bit RGB. Dynamic Color Result Screens shall be stored using Multi-frame True Color Secondary Capture Image Storage.
- The system shall also support export of result screens as 8-bit grayscale. It will sometimes be useful to export a given result screen in both color and grayscale formats. Evidence Creators that only present grayscale results are not required to export them as 24-bit RGB.
- 5690 Multiple SC and/or MFSC objects may be created in the same series to collect result screens which are associated by processing run as long as doing so doesn’t violate the Series rules outlined in RAD TF-1: Appendix E.4.1 Study UIDs and Series UIDs.

The image Instance Numbers shall be set/incremented to reflect the intended display order.

Each time processing is repeated to create new Result Screens, it shall generate a new series.

5695 Conversion Type (0008,0064) in the SC Equipment module shall have a value of “WSD” (indicating images generated by a Workstation).

Series Description (0008,103E) in the General Series module shall include an indication that these are result screens.

5700 Derivation Description (0008,2111) shall contain a description of the nature of the results and/or the processing that generated them.

Modality (0008,0060) shall reflect the modality of the data used to generate the Result Screens.

To ensure maximum compatibility with a variety of display systems, the Frame Time, Recommended Display Frame rate, and Cine Rate attributes in the Cine Module shall all be set to reflect the same frame rate.

5705 These values reflect the display rate of the stored result cine. It is not necessary to set the value to reflect “real world values” such as the actual patient heart rate.

Table 4.18-1: Required Attributes for Multiframe Secondary Capture Cine Module

Attribute	Tag	Type	Attribute Description
Preferred Playback Sequencing	(0018,1244)	R+	Describes the preferred playback sequencing for a multi-frame image. Shall have a value of 0 (which indicates Looping (1,2,..n,1,2,..n))
Cine Rate	(0018,0040)	R+	Number of frames per second at which the Evidence Creator intends the results to be presented.
Frame Time	(0018,1063)	R	Nominal time (in msec) per individual frame. Equals 1000/CineRate
Recommended Display Frame Rate	(0008,2144)	R+	Same as Cine Rate

4.18.4.1.2.5 Storage of DBT Reconstructions

5710 Evidence Creators claiming the Digital Breast Tomosynthesis (DBT) Profile shall support all of the attribute requirements in RAD TF-2:4.8.4.1.2.7 for Acquisition Modalities supporting the Breast Tomosynthesis Image Storage SOP Class.

Evidence Creators shall store derived tomosynthesis reconstructions (e.g., slabs) using the Breast Tomosynthesis Image Storage SOP Class.

4.18.4.1.3 Expected Actions

5715 The Image Archive will store the received DICOM objects.

The DICOM objects shall be stored such that they can be later retrieved (See Section 4.16 Retrieve Images) in a fashion meeting the requirements defined for a DICOM Level 2 Storage SCP (Refer to DICOM PS 3.4 B.4.1).

4.18.4.1.3.1 DICOM Image Storage SOP Classes

5720 Image Archives claiming the NM Image Profile are required to support all of the SOP classes listed in Table 4.8-3. Evidence Creators claiming the NM Image Profile are required to support at least one of the SOP classes listed in Table 4.8-3.

Evidence Creators shall be capable of providing all created Nuclear Medicine image types using the Nuclear Medicine Image SOP class.

5725 Image Archives and Evidence Creators claiming the Digital Breast Tomosynthesis (DBT) Profile are required to support the Breast Tomosynthesis Image Storage SOP Class.

Evidence Creators claiming the Result Screen Export Option are required to support all the SOP classes listed in Table 4.18-2 that are dictated by the Evidence Creators result presentation capabilities, as described in Section 4.18.4.1.2.4.

5730

Table 4.18-2: Result Screen Export SOP Classes

SOP Class UID	SOP Class Name
1.2.840.10008.5.1.4.1.1.7	Secondary Capture Image Storage
1.2.840.10008.5.1.4.1.1.7.2	Multi-frame Grayscale Byte Secondary Capture Image Storage
1.2.840.10008.5.1.4.1.1.7.4	Multi-frame True Color Secondary Capture Image Storage

4.19 Creator Presentation State Stored [RAD-19]

This section corresponds to Transaction RAD-19 of the IHE Technical Framework. Transaction RAD-19 is used by the Image Archive and Evidence Creator Actors.

5735 4.19.1 Scope

This section describes DICOM Grayscale Softcopy Presentation States Storage requests issued by the Evidence Creator to the Image Archive. The Evidence Creator sends Presentation States for storage along with the images so they could be later used for support of consistent display of imaging data. The Evidence Creator is the DICOM Store SCU and the Image Archive is the DICOM Store SCP. DICOM PS 3.4: Grayscale Softcopy Presentation State Storage defines the transformations supported by this transaction.

5740

4.19.2 Use Case Roles

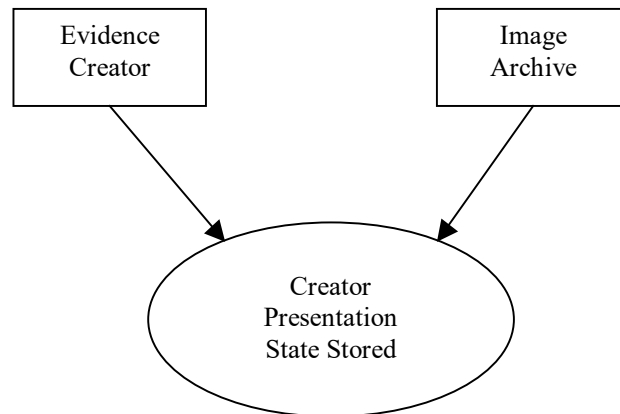

Actor: Evidence Creator

5745 **Role:** Generate Grayscale Softcopy Presentation States to be applied to image data. This actor will support the ability to send Presentation State data to an Image Archive.

Actor: Image Archive

Role: Accept and store Grayscale Softcopy Presentation State Instances received from the Evidence Creator. This transaction describes the role related only to storage of the Presentation State information.

5750

4.19.3 Referenced Standards

DICOM PS 3.4: Storage Service Class

DICOM PS 3.4: Grayscale Softcopy Presentation State Storage

DICOM PS 3.14: Grayscale Standard Display Function

5755

4.19.4 Interaction Diagram



4.19.4.1 Creator Presentation State Stored

4.19.4.1.1 Trigger Events

5760 The Evidence Creator generates a Grayscale Softcopy Presentation State Instance and sends it to the Image Archive for storage.

4.19.4.1.2 Message Semantics

5765 The Evidence Creator uses the DICOM C-STORE message to store Grayscale Softcopy Presentation States. All grayscale processing operations, and all spatial and graphical operations, that are relevant to the resulting presentation of the referenced image have to be recorded in the presentation state. This will preserve the "as-last-seen" view of the image, with for example the contrast setting, rotation, flip and text annotation. The image operations in the presentation state override whatever is recorded in the image itself, even in the case that no attributes for a specific operation (e.g., Window Width/Window Level operation) are present in the presentation state.

5770 The latter case by definition specifies an identity operation. The full message semantics are defined in the Grayscale Softcopy Presentation State Storage SOP Class behavior section of DICOM PS 3.4.

5775 The Evidence Creator derives images and Grayscale Softcopy Presentation State objects from source images that may include Modality Performed Procedure Step relationship information. This information will include Scheduled Procedure Step information for the procedure performed at an Acquisition Modality. When present in the source images, the Evidence Creator shall extract appropriate Scheduled Procedure Step information and include it with PPS information produced by the Evidence Creator.

5780 Grayscale Softcopy Presentation States that reference multi-frame images shall populate the Referenced Frame Number (0008,1160) in each applicable occurrence of the Referenced Image Sequence (0008,1140) in the Grayscale Softcopy Presentation State, unless the presentation state applies to all the frames in the image.

4.19.4.1.3 Expected Actions

5785 The Image Archive will store the received Grayscale Softcopy Presentation State objects.

4.20 Creator Procedure Step In Progress [RAD-20]

5790 This section corresponds to Transaction RAD-20 of the IHE Technical Framework. Transaction RAD-20 is used by the Department System Scheduler/Order Filler, Image Manager, Performed Procedure Step Manager and Evidence Creator Actors.

4.20.1 Scope

5795 This Performed Procedure Step of the Evidence Creator will be appended to the Modality Performed Procedure Steps done at the Acquisition Modality for the same Scheduled Procedure Step. It includes a message from the Evidence Creator to the Performed Procedure Step Manager, which in turn issues the messages to the Department System Scheduler/Order Filler and the Image Manager. The Performed Procedure Step Manager must support forwarding messages to two different destinations. It shall start issuing messages to the configured destinations immediately after it accepts the corresponding messages from the Evidence Creator. For the details on the Performed Procedure Step Manager refer to Section 4.6.1.

5800 4.20.2 Use Case Roles

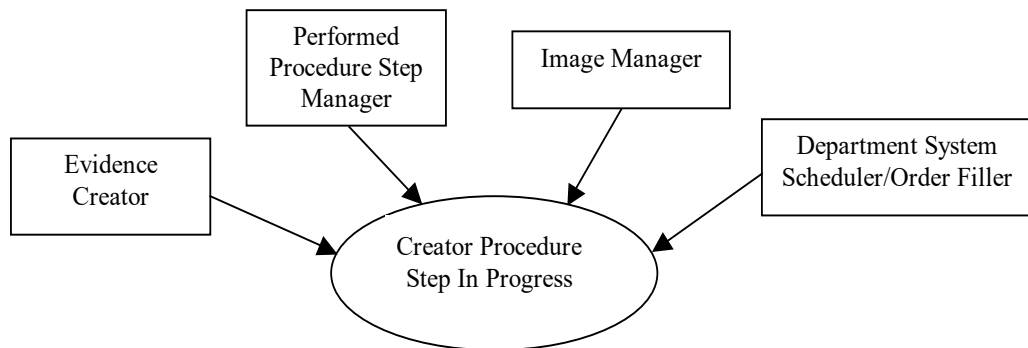

Actor: Department System Scheduler/Order Filler

Role: Receives the PPS information forwarded by the Performed Procedure Step Manager

Actor: Image Manager

5805 **Role:** Receives the PPS information forwarded by the Performed Procedure Step Manager

Actor: Evidence Creator

Role: Informs the Performed Procedure Step Manager that a particular Performed Procedure Step has started

Actor: Performed Procedure Step Manager

5810 **Role:** Accepts Performed Procedure Step information from an Evidence Creator and transmits it to the Department System Scheduler/Order Filler and Image Manager

4.20.3 Referenced Standards

DICOM PS 3.4: Modality Performed Procedure Step SOP Class.

4.20.4 Interaction Diagram

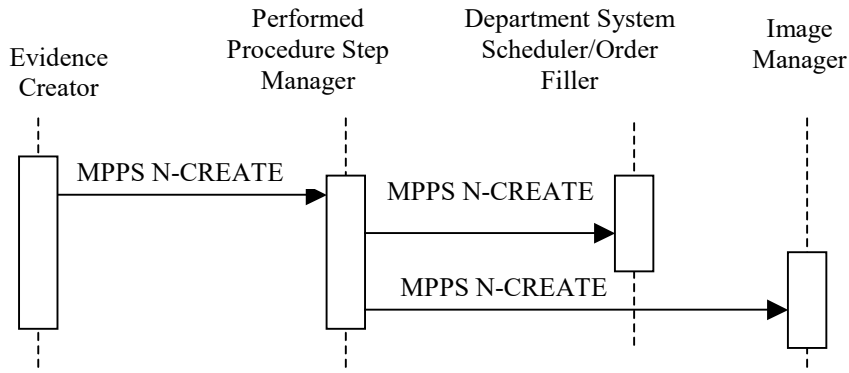

5815

4.20.4.1 Procedure Step Started Message

4.20.4.1.1 Trigger Event

Technologist begins with the generation of DICOM objects such as images, Key Image Notes or Presentation States at the Evidence Creator station.

5820 4.20.4.1.2 Message Semantics

The Evidence Creator uses the Modality Performed Procedure Step SOP Class (N-CREATE Service) to inform the Performed Procedure Step Manager that a specific image generation Procedure Step has been started and is in progress. In turn, the Performed Procedure Step Manager uses the N-CREATE Service to forward the information to the Department System Scheduler/Order Filler and Image Manager. The SOP Instance UID value of the Performed Procedure Step shall be conveyed in the Affected SOP Instance UID (0000,1000) during this interchange (see also corresponding notes in Appendix A.1). The following aspects shall be taken into the account during implementation of this step.

5825 4.20.4.1.2.1 Patient/Procedure/Procedure Step Information

5830 The Evidence Creator shall ensure that the Patient/Procedure/Procedure Step information it has is valid and current. In this case a Modality Worklist does not provide the identification and relationship information, but the Evidence Creator extracts the Scheduled Procedure Step information from the images it uses as originals. If those images satisfied several Scheduled Procedure Steps, information about all of them may be recorded in the resulting PPS messages and image headers.

5835

4.20.4.1.2.2 Required Attributes

Appendix A lists a number of attributes that have to be properly handled by the Evidence Creator to ensure consistency between Performed Procedure Step object attributes and information included into the generated images.

5840 **4.20.4.1.2.3 Relationship between Scheduled and Performed Procedure Steps**

In this case the Scheduled Procedure Step is specified in the relationship part of the MPPS information in the source images. Therefore we have the Append Case relationship between Scheduled and Performed Steps. Refer to Appendix A for details of forming attributes (Study Instance UID, Procedure ID, Accession Number, etc.) in this case.

5845 **4.20.4.1.2.3.1 Append Case**

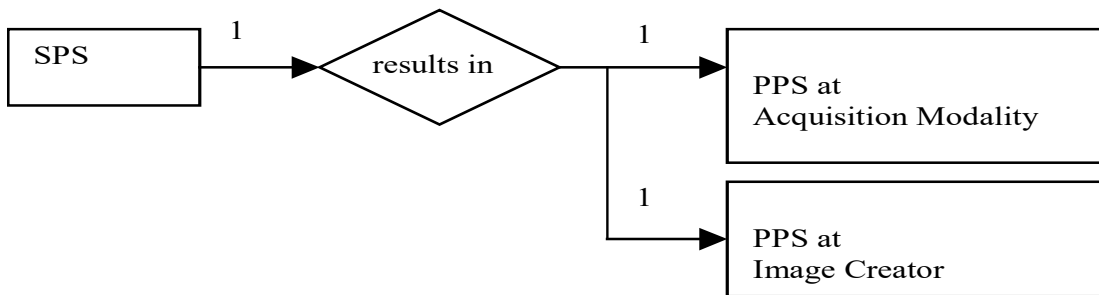

Figure 4.20.4.1.2.3.1-1: Append to a Normal Case

5850 This is a special case of 1-to-N relationship between SPS and PPS where the first PPS is
 generated at the Acquisition Modality in response to an SPS. The new Performed Procedure Step
 is added at the Evidence Creator at a later time. The Performed Procedure Step will refer back to
 the same Requested Procedure and to the original SPS. All Requested Procedure and Scheduled
 Procedure Step attributes contained in the source images shall be copied to the Performed
 5855 Procedure Step Relationship Module and the image Request Attribute Sequence (see Appendix
 A).

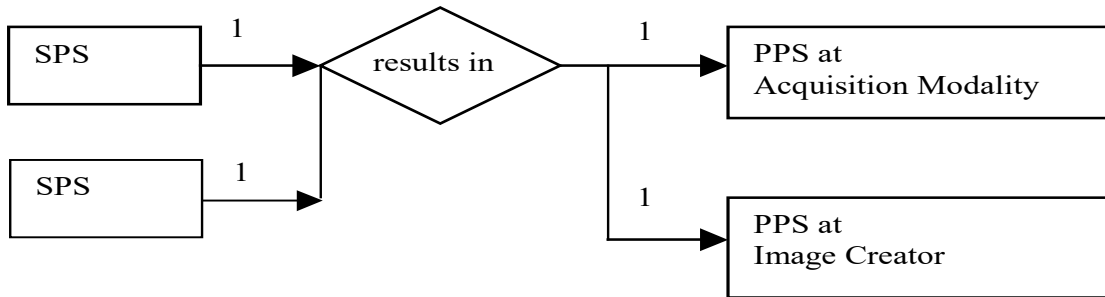

Figure 4.20.4.1.2.3.1-2: Append to a Group Case

5860 When the first PPS generated at the Acquisition Modality results from a Group Case (See
 5865 Section 4.6.4.1.2.3.4 or 4.6.4.1.2.3.6), the Performed Procedure Step appended by the Evidence
 Creator may refer back to any one or more of the original SPSs and related Requested
 Procedure(s) which were grouped, using information from the Request Attribute Sequence in the
 original images. The corresponding attributes shall be copied from the images to the Performed
 Procedure Step Relationship Module and the image Request Attribute Sequence (see Appendix
 A).

Note: For example, following a PPS performed on an MR Modality in response to the grouping of a "neck" SPS and a
 "head" SPS, a 3D analysis on the MR head images is performed on the Image Display/Creator. This Display/Creator
 application may choose to link the appended PPS associated with the 3D secondary captures images resulting from
 the 3D analysis with both the head and the neck SPSs.

5870 **4.20.4.1.3 Expected Actions**

The DSS/Order filler receives information from the Performed Procedure Step Manager and
 links it with the Requested Procedure. If the Requested Procedure ID is transmitted empty, the
 Department System Scheduler/Order Filler and the Image Manager will create an exception that
 must be manually resolved to link the Performed Procedure Step to the appropriate procedure.

5875

4.21 Creator Procedure Step Completed [RAD-21]

5880 This section corresponds to Transaction RAD-21 of the IHE Technical Framework. Transaction RAD-21 is used by the Department System Scheduler/Order Filler, Image Manager, Performed Procedure Step Manager and Evidence Creator Actors.

4.21.1 Scope

5885 This transaction includes a message from the Evidence Creator to the Performed Procedure Step Manager, which in turn issues the messages to the DSS/Order Filler and the Image Manager that the Performed Procedure Step has been completed. Information is not being released for billing at this point but a code may be assigned. The Image Manager may need the information to co-locate SOP instances of the same study. The Performed Procedure Step Completed message does not necessarily mean that the set of images is complete or available for retrieval.

4.21.2 Use Case Roles

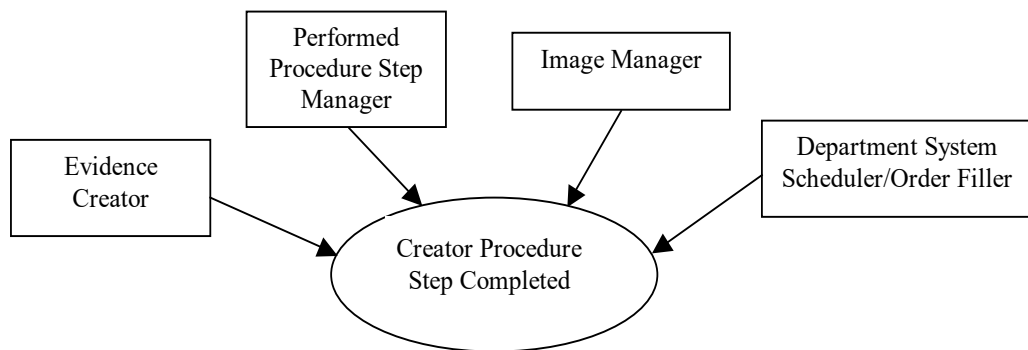

5890

Actor: Departmental System Scheduler/Order Filler

Role: Receives the PPS information forwarded by the Performed Procedure Step Manager

Actor: Image Manager

Role: Receives the PPS information forwarded by the Performed Procedure Step Manager

5895

Actor: Evidence Creator

Role: Informs the Performed Procedure Step Manager that a particular Performed Procedure Step is completed

Actor: Performed Procedure Step Manager

5900

Role: Accepts Performed Procedure Step information from an Evidence Creator and transmits it to the Department System Scheduler/Order Filler and the Image Manager

4.21.3 Referenced Standards

DICOM PS 3.4: Modality Performed Procedure Step SOP Class.

4.21.4 Interaction Diagram

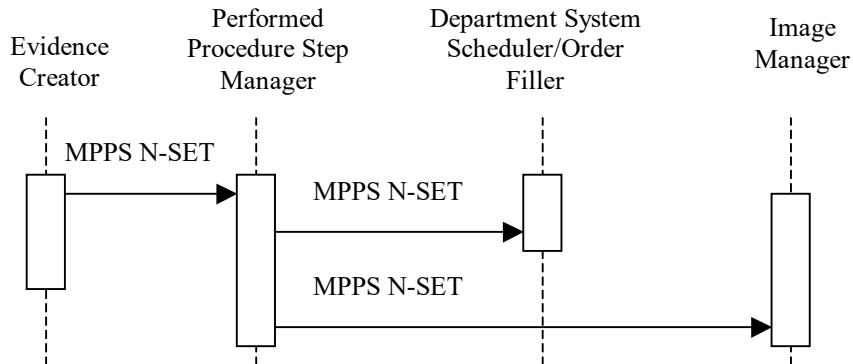

5905

Note: The diagram above shows the sequencing of messages for the Performed Procedure Step SOP Class. Evidence Creators will also implement the Storage and Storage Commitment classes. The timing relationship between MPPS messages and Storage and Storage Commitment messages is not specified. That is, MPPS messages may occur before or after storage requests.

4.21.4.1 Procedure Step Completed/Discontinued

5910

4.21.4.1.1 Trigger Event

Technologist completes the procedure step from the Evidence Creator station.

4.21.4.1.2 Message Semantics

5915

The Evidence Creator uses the Modality Performed Procedure Step SOP Class (N-SET Service) to inform the Performed Procedure Step Manager that a specific Procedure Step has been completed or discontinued. For further details on the message semantics refer to Section 4.7.4.1.2.

5920

The Evidence Creator derives images and Grayscale Softcopy Presentation State objects from source images that include Performed Procedure Step information. This information will include scheduled step information for the procedure performed at an Acquisition Modality. When present in the source images, the Evidence Creator shall extract appropriate PPS information and include it with the PPS messages and the images produced by the Evidence Creator.

Note: DICOM specifies that when attributes are allowed to be set by an N-SET, the value provided by the last N-SET overrides any value set by an earlier N-CREATE or N-SET.

4.21.4.1.2.1 PPS Exception Management Option

5925

When an Evidence Creator supports the PPS EXCEPTION MANAGEMENT Option, it shall provide the appropriate reason codes (often selected by the operator) in the final N-SET sent with the status of DISCONTINUED.

5930

When the Modality Procedure Step is sent with the Status DISCONTINUED, the Modality Procedure Step Discontinuation Reason Code Sequence (0040,0281) shall be sent with one of the values defined in Table 4.7-1 Context ID 9300 – Procedure Discontinuation Reasons

The Reason Code when communicated to the DSS/Order Filler and Image Manager/Archive may imply canceling an order. It may also facilitate more accurate charge posting.

5935 **4.22 Intentionally Left Blank**

This transaction was defined in earlier versions of the Radiology Technical Framework. It is now combined with Modality Storage Commitment in Transaction RAD-10.

5940 **4.23 Print Request with Presentation LUT [RAD-23]**

This section corresponds to Transaction RAD-23 of the IHE Technical Framework. Transaction RAD-23 is used by the Print Composer and Print Server Actors.

4.23.1 Scope

5945 This transaction supports the capability of the Print Composer to ensure display consistency for images rendered by the Print Server. The Print Composer sends a DICOM Print Request to the Print Server. The request includes the specification of a Presentation Look Up Table (LUT) to be applied to the image data at the Film Box level. The Print Composer will be the DICOM Print SCU and the Print Server will be the DICOM Print SCP.

4.23.2 Use Case Roles

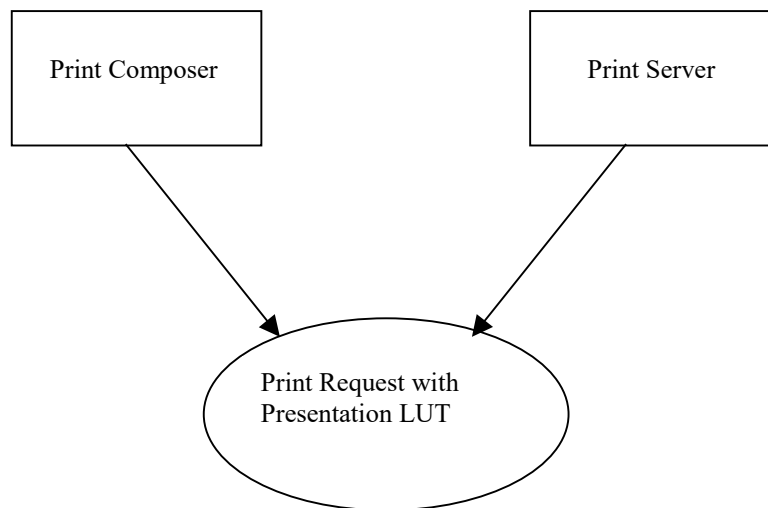

5950

Actor: Print Composer

Role: Generate DICOM Print Requests as a DICOM Print SCU. Systems which include display capability must support pixel rendering according to the DICOM Grayscale Standard Display Function (GSDF) as defined in DICOM PS 3.14. The Print Requests must specify and reference Presentation LUTs to be applied by the SCP to the image data to maintain desired image perception.

5955

Actor: Print Server

Role: Process DICOM Print Requests as a DICOM Print SCP. The system must support pixel rendering according to the DICOM Grayscale Standard Display Function (GSDF) as defined in DICOM PS 3.14 and be able to transform the image data using the specified Presentation LUT to produce the desired image perception.

5960

4.23.3 Referenced Standards

DICOM PS 3.4: Print Management Service Class

DICOM PS 3.4: Presentation LUT SOP Class

5965 DICOM PS 3.14: Grayscale Standard Display Function

4.23.4 Interaction Diagram

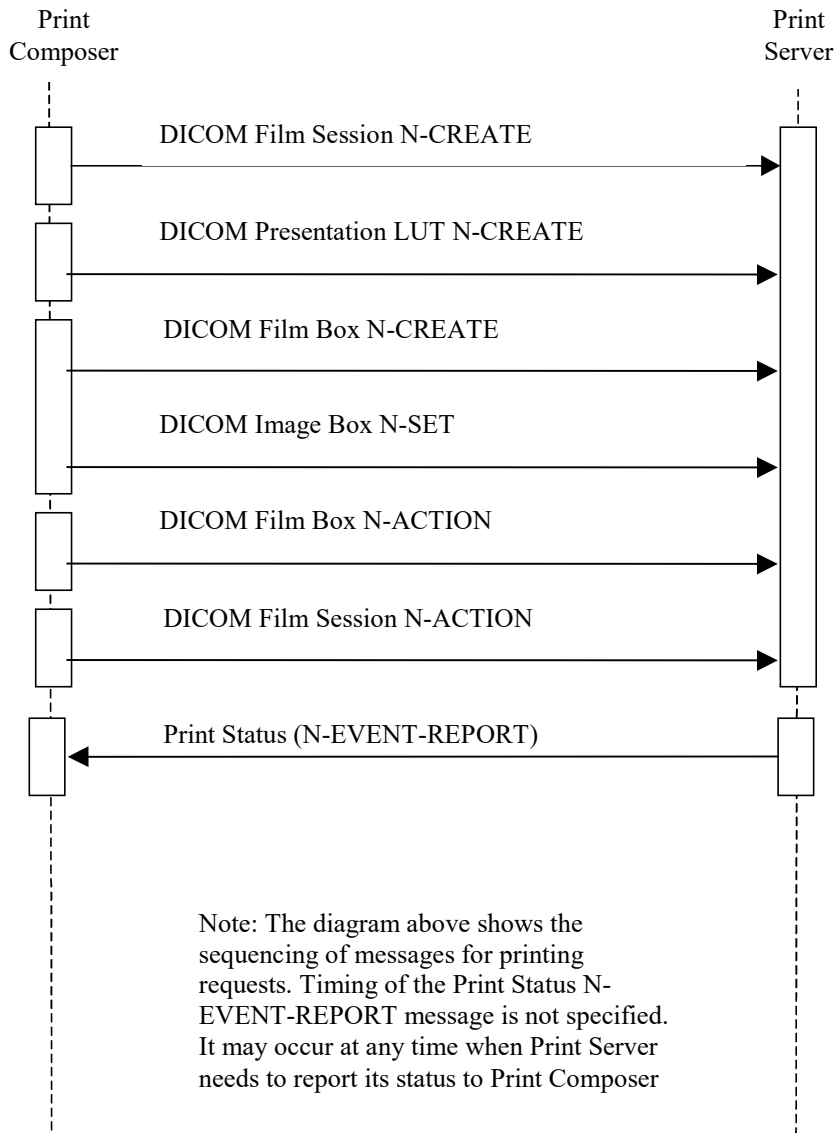

4.23.4.1 DICOM Film Session N-CREATE

5970 Support of this message is required for the Print Composer and Print Server in the IHE Technical Framework. The Film Session N-CREATE message describes the presentation parameters

common to all sheets of film in a film session. Implementation of this message will be according to the DICOM Basic Print Management Meta SOP Class.

4.23.4.1.1 Trigger Events

The Print Composer initiates a Print Request to the Print Server.

5975 **4.23.4.1.2 Message Semantics**

The DICOM Print Management Service Class Behavior defines the message semantics for the Basic Film Session SOP Class.

4.23.4.1.3 Expected Actions

5980 The Print Server shall create the Film Session SOP Instance and initialize attributes as specified in the N-CREATE. The Print Server shall return the status code of the requested SOP Instance creation as defined for the Basic Film Session SOP Class.

4.23.4.2 DICOM Presentation LUT N-CREATE

5985 The Presentation LUT data specified by this N-CREATE will be used to transform the image data at the film box level to realize specific image display characteristics suitable to the Print Composer. In addition, this message can use the Presentation LUT Shape Attribute to specify a pre-defined Presentation LUT Shape (The Presentation LUT Shape value of “LIN OD” will not be supported for the IHE Radiology Technical Framework, except for the Mammography Image Profile (see Section 4.23.4.8). Presentation LUT information will only be specified and applied at the Film Box level.

5990 Note: In the event a Print Composer chooses to specify a Presentation LUT Shape of IDENTITY instead of a Presentation LUT then the image data will be sent to the Print Server in the form of P-values for interpretation by the Print Server according to the GSDF.

5995 Note: Print composers are encouraged to refer to Appendix B of DICOM Part 14 for calibration measurements requirements. Where these data are not available or when it is uncertain on which viewbox the film will be viewed, Print Composers may use the suggested default values specified in Part 14 of the DICOM standard for the attributes of Illumination (2010,015E) and Reflected Ambient Light (2010,0160) for conventional images (for Mammography Image Requirements, see Section 4.23.4.8). For transmissive hardcopy printers the standard recommends 2000 cd/m² for Illumination and 10 cd/m² for reflected ambient light. For reflective hardcopy printers the standard recommends 150 cd/m² for Illumination (maximum luminance obtainable from diffuse reflection of the illumination present.)
6000 These values are also consistent with those used in the illustrative examples in Annex D of Part 14 of the standard.

4.23.4.2.1 Trigger Events

This message will be triggered when the Print Composer receives a successful status response from the Print Server following transmission of the Film Session N-CREATE message.

4.23.4.2.2 Message Semantics

6005 The DICOM Print Management Service Class Behavior defines the message semantics for the Presentation LUT SOP Class. Presentation LUTs supplied by the Print Composer will be required to have a number of entries corresponding to the bit depth of the image data (e.g., 256 entries for 8 bit image data, 4096 entries for 12 bit image data).

4.23.4.2.3 Expected Actions

6010 The Print Server shall create a Presentation LUT SOP Instance and initialize attributes as specified in the N-CREATE. The Print Server shall return the status code of the requested SOP Instance creation as defined for the Presentation LUT SOP Class.

4.23.4.2.4 User Specifiable Lighting Condition Option

6015 When a Print Composer supports the User Specifiable Lighting Condition Option, it shall provide the means to override the default values for the attributes of Illumination (2010,015E) and Reflected Ambient Light (2010,0160).

6020 The suggested default values specified in Part 14 of the DICOM standard for the attributes of Illumination (2010,015E) and Reflected Ambient Light (2010,0160) are clinical practice guidelines for average viewing conditions which are sufficient in cases where the clinical user does not know on which light box the film will be viewed (see also the Consistent Presentation of Images whitepaper by Marco Eichelberg, et. al. entitled Consistency of Softcopy and Hardcopy: Preliminary Experiences with the new DICOM Extensions for Image Display, Proceedings of SPIE 2000.).

4.23.4.3 DICOM Film Box N-CREATE

6025 Per the DICOM standard support of this message is required by the Print Composer and Print Server in the IHE Radiology Technical Framework. The Film Box N-CREATE message describes the presentation parameters common to a single sheet of film in a film session.

4.23.4.3.1 Trigger Events

6030 This message will be triggered when the Print Composer receives a successful status response from the Print Server following transmission of the Presentation LUT N-CREATE message.

4.23.4.3.2 Message Semantics

6035 The DICOM Print Management Service Class Behavior defines the message semantics for the Basic Film Box SOP Class. A Film Box N-CREATE will be issued for each sheet of film in a multi-film session. The Print Composer, behaving as a DICOM Print SCU, may use default values for Illumination (2010,015E), Reflective Ambient Light (2010,0160), Min Density (2010,0120), and Max Density (2010,0130) as specified in DICOM PS 3.14. In addition, the Film Box N-CREATE message will reference Presentation LUT SOP instances created by the Presentation LUT N-CREATE message. Table 4.23-1 below specifies the Basic Film Box Attribute values required to be supported by the SCU.

6040 **Table 4.23-1: Film Box Module Attributes Supported by the Print Composer**

Tag	Attribute Name	Supported Values
(2010,0010)	Image Display Format	STANDARD\C, R (C = columns, R = rows)

Tag	Attribute Name	Supported Values
(2010,0040)	Film Orientation	PORTRAIT LANDSCAPE
(2010,0050)	Film Size ID	8INX10IN 11INX14IN 14INX17IN
(2010,0060)	Magnification Type	REPLICATE BILINEAR CUBIC NONE

4.23.4.3.3 Expected Actions

6045 The Print Server shall create the Film Box SOP Instance and initialize attributes as specified in the N-CREATE. The Print Server will create an Image Box SOP Instance for each image box defined by the Image Display Format attribute (2010,0010) at the time the Basic Film Box SOP Instance is created. The Print Server shall return the status code of the requested SOP Instance creation as defined for the Basic Film Box SOP Class. Additional behavior is defined in the description of the Basic Film Box SOP Class for the DICOM Print Management Service Class within the DICOM Standard.

4.23.4.4 DICOM Image Box N-SET

6050 Per the DICOM standard support of this message is required by Print Composer and Print Server in the IHE Technical Framework. The Image Box N-SET message describes the presentation parameters and image pixel data specific to a single image box on a single sheet of film within a film session.

4.23.4.4.1 Trigger Events

6055 This message will be triggered when the Print Composer receives a successful status response from the Print Server following transmission of the Film Box N-CREATE message.

4.23.4.4.2 Message Semantics

6060 The DICOM Print Management Service Class Behavior defines the message semantics for the Image Box SOP Classes. An Image Box N-SET will be issued for each Image Box defined by the Display Format attribute (2010,0010) of the Film Box N-CREATE message.

4.23.4.4.3 Expected Actions

The Print Server will apply the specified image box attributes to the Image Box SOP Instance. The Print Server shall return the status code of the requested SOP Instance update as defined for the Image Box SOP Class.

6065 **4.23.4.5 DICOM Film Box N-ACTION**

Support of this message is required by the Print Composer and Print Server in the IHE Technical Framework. The Film Box N-ACTION message is used to print a single sheet of film in the film session.

4.23.4.5.1 Trigger Events

6070 This message will be triggered when the Print Composer receives a successful status response from the Print Server following transmission of the last Image Box N-SET message for the specified Film Box.

4.23.4.5.2 Message Semantics

6075 The DICOM Print Management Service Class Behavior defines the message semantics for the Film Box SOP Classes.

4.23.4.5.3 Expected Actions

6080 The Print Server prints the sheet of film described by the film box. Presentation LUT SOP Instances referenced at the Film Box or Image Box levels will be applied to the image data. The Print Server shall return the appropriate status code as defined for the Film Box N-ACTION DIMSE Service of the DICOM Print Management Service Class.

4.23.4.6 DICOM Film Session N-ACTION

Support of this message is optional by the Print Composer and Print Server in the IHE Technical Framework. The Film Session N-ACTION message is used to print all sheets of film in the film session.

6085 **4.23.4.6.1 Trigger Events**

This message will be triggered when the Print Composer receives a successful status response from the Print Server following transmission of the last Image Box N-SET message for the specified Film Session.

4.23.4.6.2 Message Semantics

6090 The DICOM Print Management Service Class Behavior defines the message semantics for the Film Session SOP Classes.

4.23.4.6.3 Expected Actions

6095 The Print Server prints the film session. Presentation LUT SOP Instances referenced at the Film Box or Image Box levels will be applied to the image data. The Print Server shall return the appropriate status code as defined for the Film Session N-ACTION Service of the DICOM Print Management Service Class.

4.23.4.7 Print Status (N-EVENT-REPORT)

6100 Per the DICOM standard, support of this message is required by the Print Composer and Print Server in the IHE Radiology Technical Framework. The N-EVENT-REPORT is used to report Print Server status to the Print Composer in an asynchronous manner. That is, a print SCP may send an N-EVENT-REPORT message while the SCU is transmitting additional print commands. The SCU and SCP are required to accommodate these asynchronous messages.

4.23.4.7.1 Trigger Events

6105 This message will be triggered when the Print Server senses a change in the status related to the Print Request that is worthy of notification to the Print Composer.

4.23.4.7.2 Message Semantics

The DICOM Print Management Service Class Behavior defines the message semantics for the Printer SOP Class.

4.23.4.7.3 Expected Actions

6110 The Print Composer will return the confirmation of the N-EVENT-REPORT operation to the Print Server.

4.23.4.8 Mammography Image and Digital Breast Tomosynthesis Profile

6115 Requirements specific to print are specified for mammography since there are regulatory requirements in many jurisdictions with respect to the need to provide the patient with images of primary diagnostic quality that are appropriately annotated.

Print Composers participating in the Mammography Image Profile or the Digital Breast Tomosynthesis Profile shall:

- 6120 • Be capable of true size printing of all the pixels of a single view per sheet of film based on the value stored in Imager Pixel Spacing (0018,1164) in the Mammography Image SOP Instances being printed, so that distance measurements made optically on the printed film will be approximately equivalent to those made on a film-screen mammography exposure, and shall use Requested Image Size (2020,0030) to command the Print Server to use the correct image size. Note that the Imager Pixel Spacing (0018, 1164) should not be corrected by Estimated Radiographic Magnification Factor (0018,1114), since doing so for magnified views would not only exceed the size of the available print area, but would deviate from the accepted film-screen practice.
- 6125
- 6130 • For Breast Tomosynthesis Image SOP Instances, be capable of true size printing of all the pixels of a selected frame per sheet of film based on the value stored in Pixel Spacing (0020,0030), and shall use Requested Image Size (2020,0030) to command the Print Server to use the correct image size. When printing selected frames of a magnified view, if printing the entire field of view, the Print Composer shall not send Requested Image Size (2020,0030).

- Be capable of justifying the images in the print request such that the chest wall will be printed as close to the edge of the film as the Print Server is capable.
 - 6135 • Be capable of sending the Maximum Density attribute (2010,0130).
 - For Digital Mammography X-Ray Image SOP instances, be capable of burning into the pixel data sent to the Print Server all the annotations defined in the clinical set for Image Displays in Section 4.16.4.2.2.1.1.5.1 Annotation of Identification Information, and additionally Institution Address (0008,0081), Section 4.16.4.2.2.1.1.5.2 Annotation of Technical Factor Information, and Section 4.16.4.2.2.1.1.5.3 Annotation of View Information.
 - 6140 • For Breast Tomosynthesis Image SOP instances, be capable of burning into the pixel data sent to the Print Server all the annotations defined in the clinical set for Image Displays in Section 4.16.4.2.2.1.3.5.1 Annotation of Identification Information and additionally Institution Address (0008,0081), Section 4.16.4.2.2.1.3.5.2 Annotation of Technical Factor Information and Section 4.16.4.2.2.1.3.5.3 Annotation of View Information.
 - 6145 • Be capable of burning a ruler, caliper or other form of distance scale into the pixel data sent to the Print Server
 - Be capable of transmitting a pixel data bit depth of 12 bits to the Print Server (i.e., an 8 bit path is not sufficient for mammography)
 - 6150 • Be capable of burning into the pixel data sent to the Print Server a VOI LUT transformation (linear, sigmoid or tabular) as selected by the user from those available in the original image or as otherwise provided by the user
- Print Servers participating in the Mammography Image Profile or the Digital Breast Tomosynthesis Profile shall:
- 6155 • Print on transmissive media
 - Be capable of true size printing based on the Requested Image Size (2020,0030) and shall attain the requested size with a precision of a maximum 2% error in linear distance (this precision requirement is chosen based not any implied or required accuracy of measurements from film or projection radiography, but rather because current electrical, mechanical and optical technology readily allows for this precision, and deviation beyond this value indicates a fundamental flaw in the implementation of the protocol or logic)
 - 6160 • Be capable of printing with a border between the chest wall edge of the digital mammography image and the physical edge of the film no greater than 5mm, so that the printed films can be hung on a light box with the chest wall edges of corresponding views directly abutted.
 - 6165 • Be capable of applying the Maximum Density attribute (2010,0130) in the request, and printing with a maximum optical density no less than 3.5
 - Be capable of receiving a pixel data bit depth of 12 bits from the Print Composer (i.e., an 8 bit path is not sufficient for mammography).
 - 6170

- Be capable of using a Presentation LUT Shape value of “IDENTITY” and “LIN OD” and the Presentation LUT Sequence (2050,0010)

6175 Note that support for a Presentation LUT Shape value of “LIN OD” by Print Servers is specified for Mammography since the expected transmitted illumination of mammography view boxes on which printed film may be hung exceeds the range of illumination for which the Barten model is defined, and hence it may be difficult to achieve consistency between prints, and between prints and displays. It allows the Print Composer to use “LIN OD” to have greater control over the optical density of the printed film, and to take what action is necessary to result in consistency of appearance for the anticipated viewing conditions.

6180

4.24 Report Submission [RAD-24]

This section corresponds to Transaction RAD-24 of the IHE Technical Framework. Transaction RAD-24 is used by the Report Creator and Report Manager Actors.

4.24.1 Scope

6185 In the Report Submission transaction, the Report Creator transmits a DICOM Structured Report (SR) object in an initial draft or final state to the Report Manager. The Structured Report object is required minimally to conform to the template TID 2000. Creators may introduce increased complexity as long as it conforms to the SOP class.

6190 A final report is defined as one where the Completion Flag (0040,A491) attribute is set to “COMPLETE” and the Verified Flag (0040,A493) attribute is set to “VERIFIED”. Reports with any other values for the Completion Flag (0040,A491) or the Verified Flag (0040,A493) attributes are considered draft reports.

4.24.2 Use Case Roles

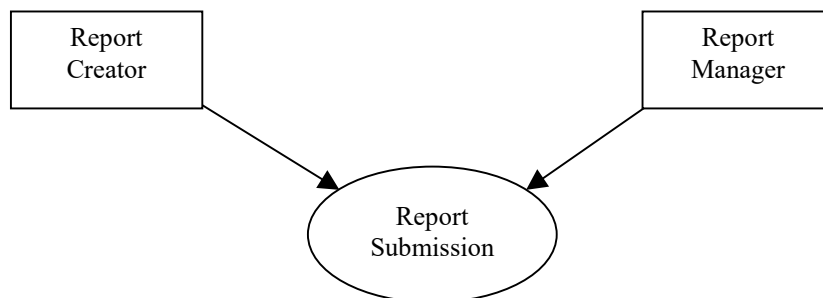

6195 **Actor:** Report Creator

Role: Transmit draft or final DICOM Structured Reports to Report Manager.

Actor: Report Manager

Role: Accept draft and final DICOM Structured Reports for management.

4.24.3 Referenced Standards

6200 DICOM PS 3.4: Storage SOP Class

DICOM PS 3.16: Content Mapping Resource

4.24.4 Interaction Diagram

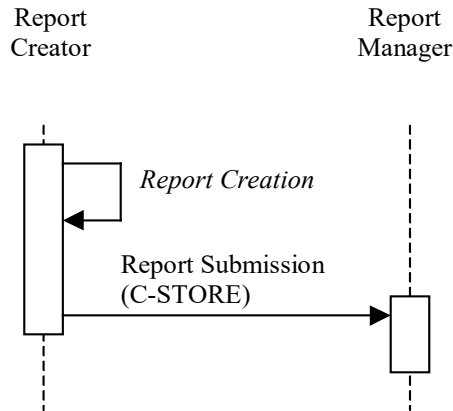

4.24.4.1 Report Creation

6205 This transaction relates to the “Report Creation” event in the above interaction diagram.

4.24.4.1.1 Trigger Events

The user at the Report Creator wishes to create a DICOM Structured Report.

4.24.4.1.2 Invocation Semantics

6210 This is a local invocation of functions at the Report Creator, and the method used by the Report Creator to obtain report data and create a DICOM Structured Report object is outside the scope of the IHE Technical Framework. The Report Creator shall create a report that conforms to the DICOM Basic Text SR Information Object Definition (IOD). If numeric values are required in the report, then the Report Creator shall create a report that conforms to the DICOM Enhanced SR IOD. A single Report Creator may support both SR IODs if this is deemed desirable by the implementers, but must at least support the Basic Text SR IOD. Reports created by the Report Creator shall also conform to the DCMR template TID 2000.

4.24.4.1.2.1 Coded Entries

6220 All Reporting actors (Report Creator, Report Manager, Report Repository, and External Report Repository Access) must be able to load configurable code tables. The DICOM Structured Report objects are dependent on coded entries to define the concepts being conveyed. Codes specified in DCMR (DICOM PS 3.16) shall be. In the absence of standard codes, the IHE Committee may define necessary codes for use in demonstrations.

6225 The types of reports created by the Report Creator are defined in RAD TF-1: 9.4. At a minimum, the Report Creator shall be able to generate reports based on the Simple Image Report (RAD TF-1: 9.4.1). If the Report Creator supports the Enhanced SR Information Object Definition then it shall also support the creation of Simple Image and Numeric Reports (RAD TF-1: 9.4.2).

4.24.4.1.2.2 Retrieve AE Title

6230 Whenever references to DICOM Composite objects are made within a DICOM Structured Report, it is possible to include the Retrieve AE Title attribute (0008,0054). In the case of the Report Creator, these references shall be contained in the Current Requested Procedure Evidence Sequence attribute (0040,A375), or the Pertinent Other Evidence Sequence attribute (0040,A385). If the Report Creator is a standalone actor it is optional for the Retrieve AE Title attribute (0008,0054) to be sent and it is up to the implementation to determine what value to send. If the Report Creator is combined with an Image Display, then it is recommended that the Retrieve AE Title attribute (0008,0054) be set to the AE Title of the device from which the Image Display retrieved the referenced DICOM Composite objects.

4.24.4.1.2.3 Study Identification and Identical Documents Sequence

6240 A Study Instance UID is required to identify the study to which the report belongs. It is recommended to use the Study Instance UID of the images reported on as the Study Instance UID of the created Structured Report. The mechanism by which the Report Creator will receive this information is defined in the IHE Technical Framework. Sometimes a single report refers to multiple studies. For example, a trauma patient may require X-rays of both the wrist and leg. These may be ordered as separate studies, but the Radiologist may report on both studies at the same time. To handle this situation in the DICOM Hierarchical Model, it is necessary to duplicate the report within each study. If a Report Creator is generating a single report for multiple studies, it shall create multiple copies of the report, with different SOP Instance UIDs for each study and use the Identical Documents Sequence attribute (0040,A525) in each report. The Identical Documents Sequence attribute (0040,A525) in each report shall reference each of the other identical reports in the other studies. The actual content of the report, that is, the SR Document General Module attributes (except the Identical Documents Sequence attribute) and the SR Document Content Module attributes shall be the same in each report instance.

6250 The Retrieve AE Title attribute (0008,0054) in the Identical Documents Sequence Items shall not be sent.

4.24.4.1.3 Expected Actions

6255 Creation of DICOM Structured Report objects ready for storage to the Report Manager.

4.24.4.2 Report Submission

This transaction relates to the “DICOM C-STORE” event between the Report Creator and Report Manager in the above interaction diagram.

4.24.4.2.1 Trigger Events

6260 When report authoring is completed and the Report Creator creates new DICOM Structured Reports, the Report Creator shall transfer DICOM Structured Reports to the Report Manager within one or more DICOM associations.

4.24.4.2.2 Message Semantics

6265 The Report Creator uses the DICOM C-STORE message to transfer DICOM Structured Reports. The Report Creator is the DICOM Storage SCU of the Basic Text SR Storage SOP Class or the Enhanced SR Storage SOP Class or both. The Report Manager is the DICOM Storage SCP of at least the Basic Text SR Storage SOP Class and optionally the Enhanced SR Storage SOP Class. In accordance with the DICOM Standard for SR the Report Manager must support Level 2 (Full) storage, which means all DICOM Type 1, 2 and 3 attributes are stored.

6270 4.24.4.2.3 Expected Actions

The Report Manager will store the received DICOM Structured Report objects. At this point the Report Creator relinquishes any responsibility for the report objects and may not change them in any way without creating a new object with a new SOP Instance UID.

6275 **4.25 Report Issuing [RAD-25]**

This section corresponds to Transaction RAD-25 of the IHE Technical Framework. Transaction RAD-25 is used by the Report Manager and Report Repository Actors.

4.25.1 Scope

6280 In the Report Issuing transaction, the Report Manager transmits either an unchanged draft DICOM Structured Report (created by a Report Creator) or a new modified DICOM Structured Report to the Report Repository or both. The Report Manager handles all state and content changes to DICOM Structured Reports, and with each change new DICOM Structured Report objects are created and may be stored in the Report Repository.

4.25.2 Use Case Roles

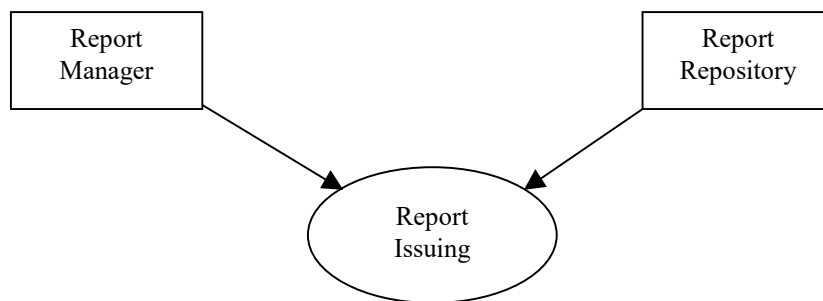

6285

Actor: Report Manager

Role: Process report changes and transmit reports to Report Repository. This involves the ability to handle content and state changes to DICOM Structured Reports and create new DICOM Structured Reports based on these changes. Examples of the types of changes the Report Manager needs to process are as follows:

6290

- Verifying a draft report and setting the verification attributes in the newly created verified report;
- Creating a new unverified report based on one or more previous draft or verified reports;
- Creating a new verified report based on one or more previous draft or verified reports; and
- Creating a new report that is the result of merging multiple previous reports.
- Generating a new version of an existing report with updated patient demographics based on receiving a Patient Update transaction.

6295

Actor: Report Repository

6300 **Role:** Accept and store DICOM Structured Reports from Report Managers.

4.25.3 Referenced Standards

DICOM PS 3.4: Storage SOP Class

DICOM PS 3.16: Content Mapping Resource

4.25.4 Interaction Diagram

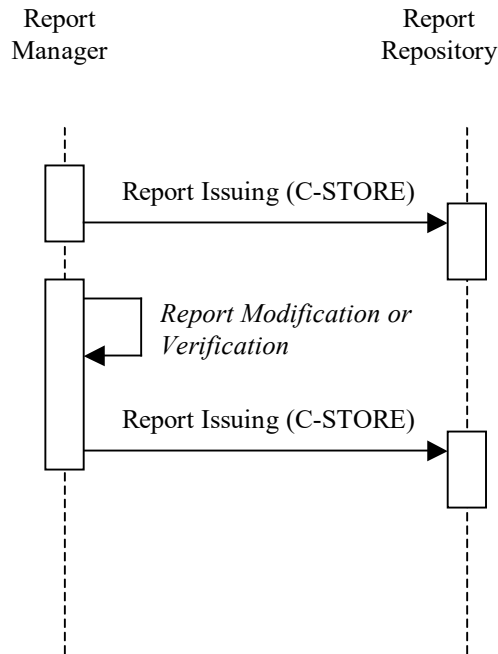

6305

4.25.4.1 Report Issuing (Step 1)

This transaction relates to the top “DICOM C-STORE” event between the Report Manager and Report Repository in the above interaction diagram.

6310 4.25.4.1.1 Trigger Events

When DICOM Structured Reports are received from the Report Creator, the Report Manager can transfer the DICOM Structured Reports to the Report Repository within one or more DICOM associations. This capability may be configurable as it may enable access to reports before they are verified and finalized. Some sites may require this feature, while others may find it undesirable.

6315

4.25.4.1.2 Message Semantics

The Report Manager uses the DICOM C-STORE message to transfer DICOM Structured Reports. The Report Manager is the DICOM Storage SCU of at least the Basic Text SR Storage SOP Class and optionally the Enhanced SR Storage SOP Class. It is required that if a Report Manager is an SCP of the Enhanced SR Storage SOP Class (see Section 4.24) then it shall also

6320

be an SCU of the Enhanced SR Storage SOP Class. The Report Repository is the DICOM Storage SCP of both the Basic Text SR Storage SOP Class and the Enhanced SR Storage SOP Class. In accordance with the DICOM Standard for SR, the Report Repository must support Level 2 (Full) storage, which means all DICOM Type 1, 2 and 3 attributes are stored.

6325 **4.25.4.1.3 Expected Actions**

The Report Repository will store the received DICOM Structured Report objects.

4.25.4.2 Report Modification

This transaction relates to the “Report Modification or Verification” event in the above interaction diagram.

6330 **4.25.4.2.1 Trigger Events**

The user at the Report Manager selects an existing report and decides to make some modification to this report.

4.25.4.2.2 Invocation Semantics

6335 This is a local invocation of functions at the Report Manager, and the method used by the Report Manager to specify report state transitions or obtain modified report data and create a new DICOM Structured Report object is outside the scope of the IHE Technical Framework. The Report Manager shall create a report that conforms to the DICOM Basic Text SR Information Object Definition or the DICOM Enhanced SR Information Object Definition if numeric values are to be included in the report either by their addition by the Report Manager or numeric values
6340 appeared in the original report received from the Report Creator. It is required that if a Report Manager can receive Enhanced SR objects, that it can also manage such objects and generate new Enhanced SR objects. If the Report Manager removes numeric values from a report it may convert an Enhanced SR object into a Basic Text SR object. When the Report Manager creates a new modified report it must be in a different series to the original report, unless the Report
6345 Manager and Report Creator are the same device. This is because the DICOM Standard requires that objects created by different devices must be in different series (i.e., different DICOM General Equipment Module attributes). In order to reference the original report, the new modified report must correctly contain the Predecessor Documents Sequence attribute (0040,A360).

6350 The types of external state changes the Report Manager shall handle are:

- Completing a partial report; and
- Verifying a report.

6355 To complete a partial report, additional content may be added to the original report and the Completion Flag attribute (0040,A491) shall be set to “COMPLETE”. To verify a report, the content of the original report is checked for correctness, and the Verification Flag attribute (0040,A493) shall be set to “VERIFIED”. This also requires that the Verifying Observer Sequence attribute (0040,A073) be completed appropriately.

6360 The types of reports that at a minimum shall be handled by the Report Manager are defined in
RAD TF-1: 9.4. The Report Manager shall be able to manipulate reports based on the Simple
Image Report (RAD TF-1: 9.4.1). If the Report Manager supports the Enhanced SR Information
Object Definition then it shall also support manipulation of Simple Image and Numeric Reports
(RAD TF-1: 9.4.2). Even though the IHE Technical Framework sets boundaries on the
6365 complexity of SR objects, the Report Manager must still be able to receive and store any Basic
Text SR object and optionally any Enhanced SR object in order to conform to the DICOM
Standard. An implementation may restrict the modification capabilities for reports more complex
than those specified in RAD TF-1: 9.4. When creating a new report, the Report Manager shall
also conform to the DCMR template TID 2000.

6370 There are many reasons and methods for the Report Manager to modify the content of a report
and these are outside the scope of the IHE Technical Framework. Examples of the types of
changes, in addition to the state changes above, the Report Manager needs to be able to process
are as follows:

- Creating a new report based on one or more previous draft or verified reports where data
is changed or added;
- 6375 • Creating a new report that is the result of merging multiple previous reports. This can
also involve changing or adding report data; and
- Converting a Basic Text SR into an Enhanced SR if the Report Manager adds
measurements. This also means that if a Basic Text SR is merged with an Enhanced SR
then the resulting object will be an Enhanced SR.

6380 It is recommended that amendments to DICOM Structured Reports are made by creating a new
DICOM Structured Report object containing the original content as well as any amendments or
additions. References to the original report are made by the Predecessor Document Sequence
attribute (0040,A360).

6385 In general report issuing requires that a new SR instance UID will be created as a result of the
rules defined by the DICOM standard, PS 3.4 – Section O.3 - Modification of SR DOCUMENT
CONTENT.

4.25.4.2.2.1 Retrieve AE Title

6390 Whenever references to DICOM Composite objects are made within a DICOM Structured
Report, it is possible to include the Retrieve AE Title attribute (0008,0054). In the case of the
Report Manager, these references will be contained in the Predecessor Documents Sequence
attribute (0040,A360), as well as the Current Requested Procedure Evidence Sequence attribute
(0040,A375) and the Pertinent Other Evidence Sequence attribute (0040,A385) if the Report
Creator uses these evidence sequence attributes.

6395 The Report Creator may send reports to the Report Manager where the Retrieve AE Title
attribute (0008,0054) in the Current Requested Procedure Evidence Sequence Items
(0040,A375), or the Pertinent Other Evidence Sequence Items (0040,A385) is empty or not sent.

In these cases the Report Manager may add the AE Title of a configured Image Manager in the Retrieve AE Title attribute (0008,0054) of these sequence items.

6400 When the Report Manager creates a new report based on one or more previous reports that it has already stored in the Report Repository, then the AE Title of the Report Repository shall be used as the Retrieve AE Title attribute (0008,0054) in the Predecessor Documents Sequence Items (0040,A360). If the prior reports have not been stored in the Report Repository then the Retrieve AE Title attribute (0008,0054) shall not be sent.

4.25.4.2.2.2 Study Identification and Identical Documents Sequence

6405 A Study Instance UID is required to identify the study to which the report belongs. It is recommended to use the Study Instance UID of the images reported on as the Study Instance UID of the created Structured Report. The mechanism by which the Report Creator will receive this information is currently undefined in the IHE Technical Framework. The expectation is that the DICOM General Purpose Worklist service will be used for this function when this service is finalized in DICOM and incorporated in the IHE Radiology Technical Framework.

6410 When the Report Manager is modifying a report that contains items in the Identical Documents Sequence attribute (0040,A525) then a decision is needed as to the actions to occur upon the other identical documents. The user modifying the report may be asked as to whether the changes may only apply to the current report or to the other identical documents as well. If the changes are limited to one report, then no Identical Documents Sequence attribute (0040,A525) shall be included in the new report as it is no longer the same as the other documents. If the changes are to apply to multiple reports, then multiple new reports with new SOP Instance UIDs shall be created with the new report data and their Identical Documents Sequence attribute (0040,A525) shall refer to the appropriate new report objects. Also in this case each Predecessor Documents Sequence attribute (0040,A360) shall refer to all the original identical documents.

6420 This is shown in Figure 4.25-1.

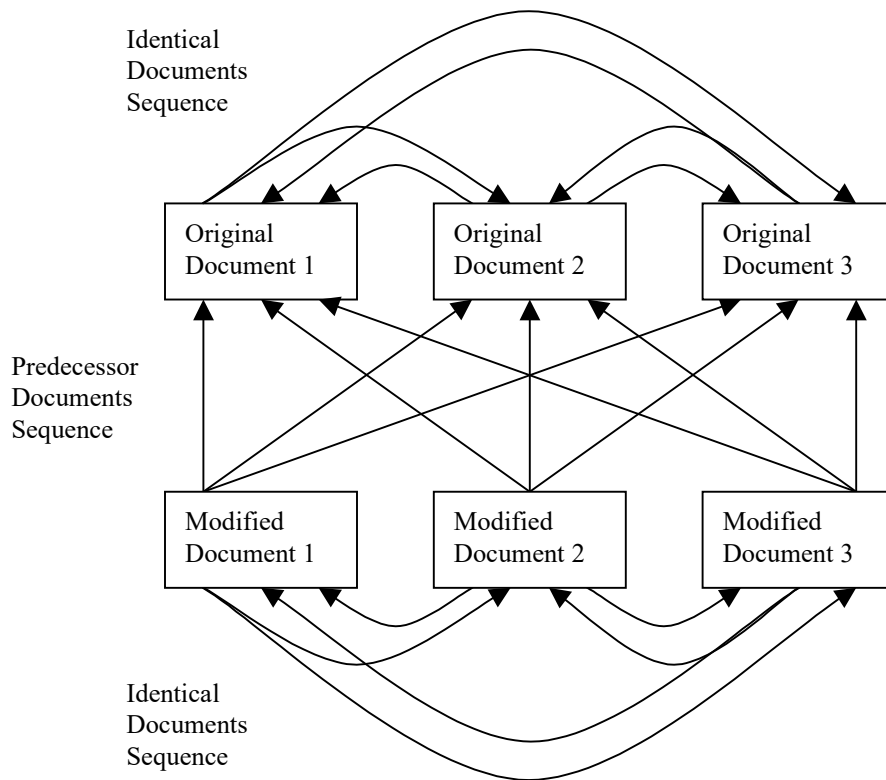

Figure 4.25-1: Identical and Predecessor Document Sequences

4.25.4.2.3 Expected Actions

6425 Creation of a new modified DICOM Structured Report object ready for storage to the Report Repository.

4.25.4.3 Report Issuing (Step 2)

This transaction relates to the bottom “DICOM C-STORE” event between the Report Manager and Report Repository in the above interaction diagram.

4.25.4.3.1 Trigger Events

6430 When reports are finalized (complete and verified) they shall be stored in the Report Repository. The Report Manager can transfer DICOM Structured Reports to the Report Repository within one or more DICOM associations. Internal reports shall be temporarily stored in the Report Manager until they are finalized, but may also be stored permanently in the Report Repository if the Report Manager decides to transfer them. The technique used by the Report Manager to
6435 finalize a report is outside the scope of the IHE Technical Framework.

4.25.4.3.2 Message Semantics

6440 The Report Manager uses the DICOM C-STORE message to transfer DICOM Structured Reports. The Report Manager is the DICOM Storage SCU of at least the Basic Text SR Storage SOP Class and optionally the Enhanced SR Storage SOP Class. It is required that if a Report Manager is an SCP of the Enhanced SR Storage SOP Class (see Section 4.24) then it shall also be an SCU of the Enhanced SR Storage SOP Class. The Report Repository is the DICOM Storage SCP of both the Basic Text SR Storage SOP Class and the Enhanced SR Storage SOP Class. In accordance with the DICOM Standard for SR the Report Repository must support Level 2 (Full) storage, which means all DICOM Type 1, 2 and 3 attributes are stored.

6445 4.25.4.3.3 Expected Actions

The Report Repository will store the received DICOM Structured Report objects.

4.26 Query Reports [RAD-26]

6450 This section corresponds to Transaction RAD-26 of the IHE Technical Framework. Transaction RAD-26 is used by the Report Manager, Report Repository, Report Reader, and External Report Repository Access Actors.

4.26.1 Scope

6455 In the Query Reports Transaction, the Report Reader queries the Report Manager, Report Repository or External Report Repository Access for draft or final DICOM Structured Reports.

4.26.2 Use Case Roles

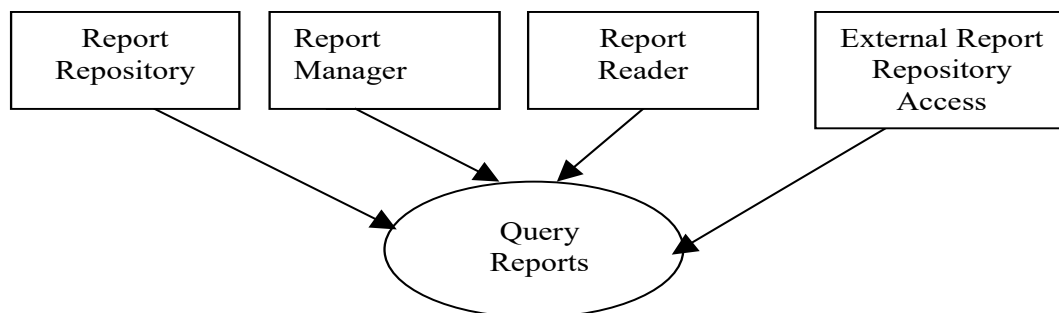

Actor: Report Repository

6460 **Role:** Responds to queries for DICOM Structured Reports.

Actor: External Report Repository Access

6465 **Role:** Responds to queries for DICOM Structured Reports. This system provides storage of DICOM Structured Reports obtained from outside the Radiology department. Such a system may be required to convert reports of different formats (HL7) into DICOM Structured Reports (see Appendix C).

Actor: Report Reader

Role: Queries Report Repository or External Report Repository Access for DICOM Structured Reports and makes them available for selection.

Actor: Report Manager

6470 **Role:** Responds to queries for DICOM Structured Reports.

4.26.3 Referenced Standards

DICOM PS 3.4: Query/Retrieve Service Class

DICOM PS 3.16: Content Mapping Resource

4.26.4 Interaction Diagram

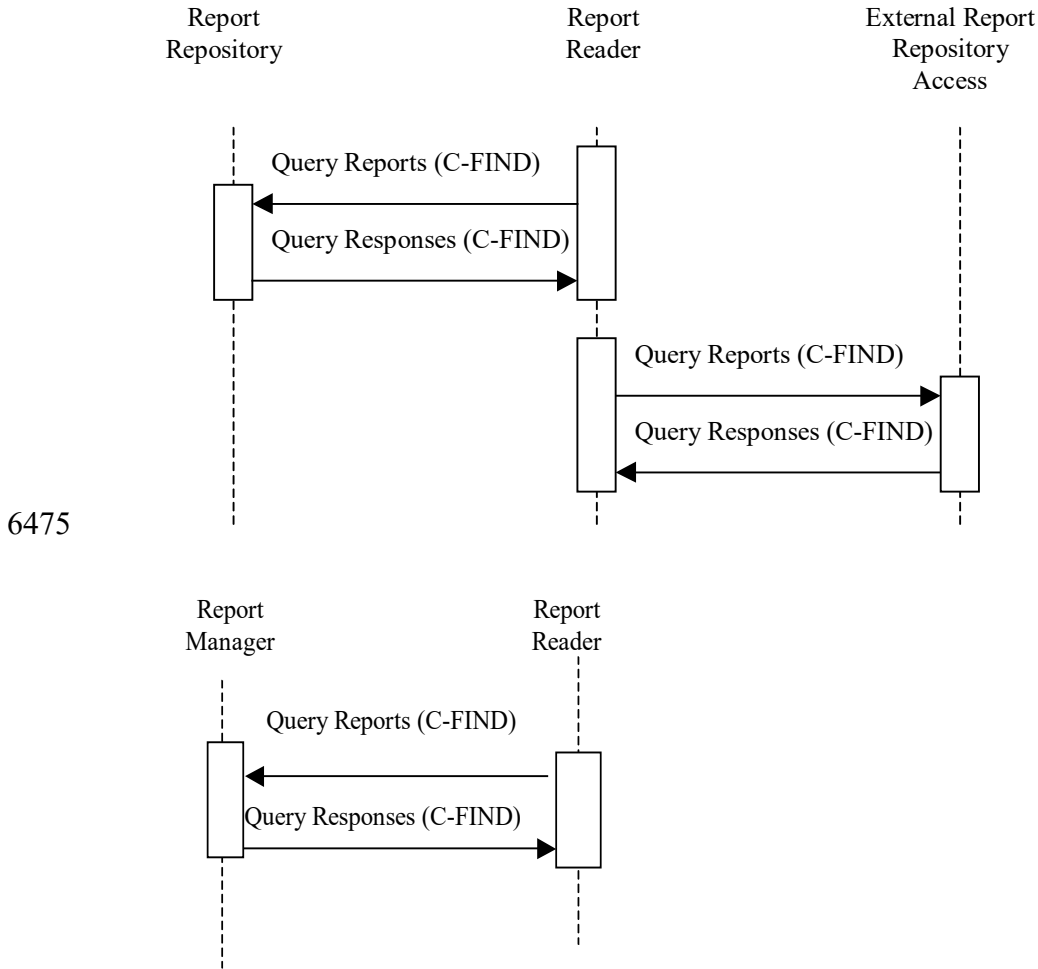

4.26.4.1 Query Reports

6480 This transaction relates to the query section of the above interaction diagram. The Query (Study Root – FIND and optionally Patient Root – FIND) SOP Classes will be supported. Refer to DICOM PS 3.4: Query/Retrieve Service Class for detailed descriptive semantics.

4.26.4.1.1 Trigger Events

The user at the Report Reader wishes to view selected reports.

4.26.4.1.2 Message Semantics

The message semantics are defined by the DICOM Query/Retrieve SOP Classes.

6485 A C-FIND Request from the DICOM Study Root Query/Retrieve Information Model – FIND SOP Class or the DICOM Patient Root Query/Retrieve Information Model – FIND SOP Class shall be sent from the Report Reader to the Report Manager, Report Repository or External Report Repository Access.

6490 The Report Reader uses one or more matching keys as search criteria to obtain the list of matching entries in the Report Manager, Report Repository or External Report Repository Access at the selected level (Patient & Study/Series/Instance).

6495 In addition to the required and unique keys defined by the DICOM Standard, the IHE Technical Framework has defined matching and return keys to be supported by query SCUs and SCPs. The keys are defined in Section 4.14.4.1.2 and Table 4.14-1, except that Report Manager and Report Repositories are not required to support PPS Start Date and PPS Start Time. The conventions for key usage are defined in Section 2.2. For the Report Reader (SCU) and the Report Manager, Report Repository and External Report Repository Access (SCP) the additional SR Instance specific keys are defined in Table 4.26-1.

Table 4.26-1: SR Instance Specific Query Matching and Return Keys

Attribute Name	Tag	Query Keys Matching		Query Keys Return	
		SCU	SCP	SCU	SCP
SR Instance Specific Level					
Completion Flag	(0040,A491)	R+	R+	R+	R+
Verification Flag	(0040,A493)	R+	R+	R+	R+
Content Date	(0008,0023)	O	O	O	R+
Content Time	(0008,0033)	O	O	O	R+
Observation DateTime	(0040,A032)	O	O	O	R+
Verifying Observer Sequence	(0040,A073)				
>Verifying Organization	(0040,A027)	O	O	R+	R+
>Verification DateTime	(0040,A030)	R+	R+	R+	R+
>Verifying Observer Name	(0040,A075)	R+	R+	R+	R+
>Verifying Observer Identification Code Sequence	(0040,A088)				
>> Code Value	(0008,0100)	O	O	R+	R+
>> Coding Scheme Designator	(0008,0102)	O	O	R+	R+
>> Coding Scheme Version	(0008,0103)	O	O	R+	R+
>> Code Meaning	(0008,0104)	O	O	R+	R+
Referenced Request Sequence	(0040,A370)				
>Study Instance UID	(0020,000D)	O	O	R+*	R+
>Accession Number	(0008,0050)	O	O	R+	R+
>Requested Procedure ID	(0040,1001)	O	O	R+	R+
>Requested Procedure Code Sequence	(0032,1064)				
>>Code Value	(0008,0100)	O	O	O	R+

Attribute Name	Tag	Query Keys Matching		Query Keys Return	
		SCU	SCP	SCU	SCP
>>Coding Scheme Designator	(0008,0102)	O	O	O	R+
>>Coding Scheme Version	(0008,0103)	O	O	O	R+
>>Code Meaning	(0008,0104)	O	O	O	R+
Concept Name Code Sequence	(0040,A043)				
>Code Value	(0008,0100)	R+	R+	R+	R+
>Coding Scheme Designator	(0008,0102)	R+	R+	R+	R+
>Coding Scheme Version	(0008,0103)	O	O	O	R+
>Code Meaning	(0008,0104)	O	O	R+	R+

6500 **4.26.4.1.3 Expected Actions**

The Report Manager, Report Repository or External Report Repository Access receives the C-FIND request, performs the matching on the provided keys and sends the list of matching records back to the Report Reader via C-FIND responses.

6505 **4.27 Retrieve Reports [RAD-27]**

Transaction RAD-27 is used by the Report Manager, Report Repository, Imaging Document Source, Report Reader, Imaging Document Consumer and External Report Repository Access Actors.

4.27.1 Scope

6510 In the Retrieve Reports Transaction, the requested DICOM Structured Reports are transferred from the Report Manager, Report Repository, Imaging Document Source, or External Report Repository Access to the Report Reader or Imaging Document Consumer for viewing.

4.27.2 Use Case Roles

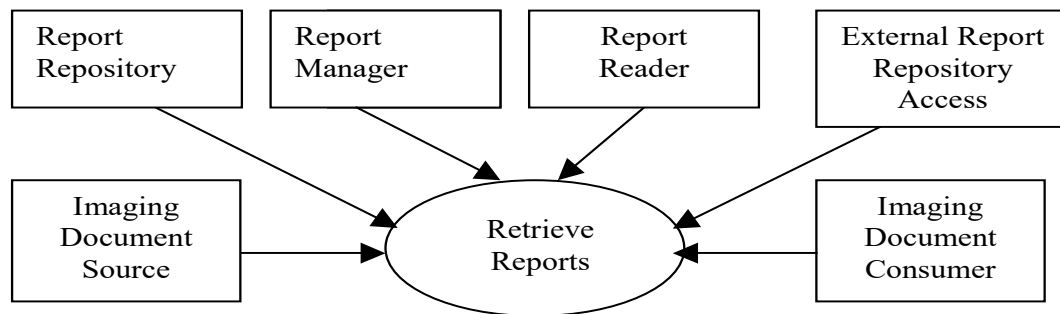

6515

Actor: Report Repository

Role: Sends requested DICOM Structured Reports to Report Reader.

Actor: Imaging Document Source

6520 **Role:** Sends requested DICOM Structured Reports to the Imaging Document Consumer.

Actor: External Report Repository Access

Role: Sends requested DICOM Structured Reports to Report Reader. Such a system may be required to convert reports of different formats (HL7) into DICOM Structured Reports (see appendix C).

6525 **Actor:** Report Reader

Role: Retrieves DICOM Structured Reports from Report Repository or External Report Repository Access and makes them available for viewing.

Actor: Imaging Document Consumer

6530 **Role:** Retrieves DICOM Structured Reports from the Imaging Document Source and makes them available for viewing.

Actor: Report Manager

Role: Sends requested DICOM Structured Reports to Report Reader.

4.27.3 Referenced Standards

DICOM PS 3.4: Query/Retrieve Service Class

6535 DICOM PS 3.4: Storage SOP Class

DICOM PS 3.16: Content Mapping Resource

4.27.4 Interaction Diagram

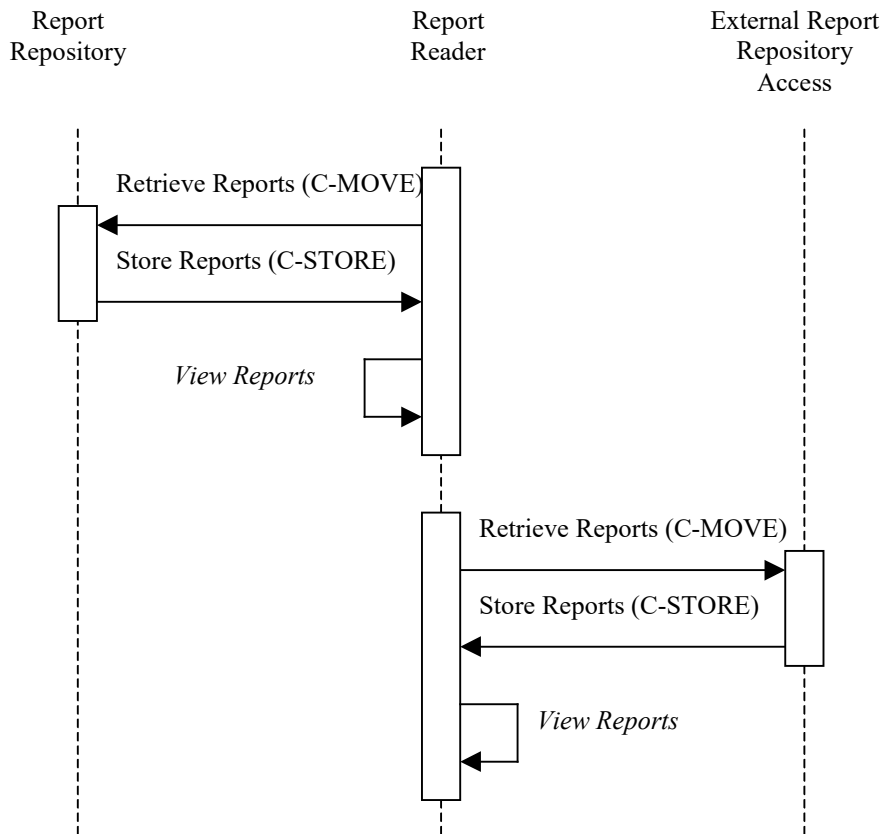

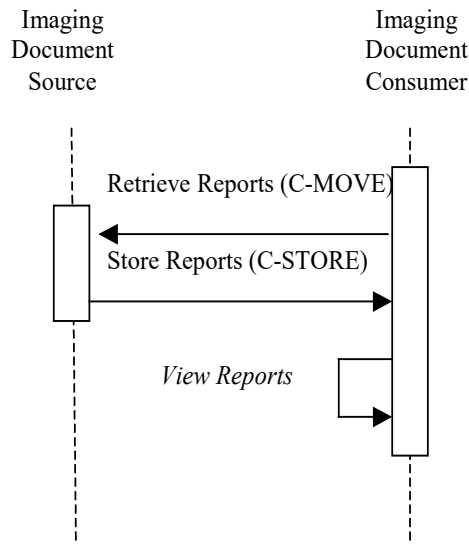
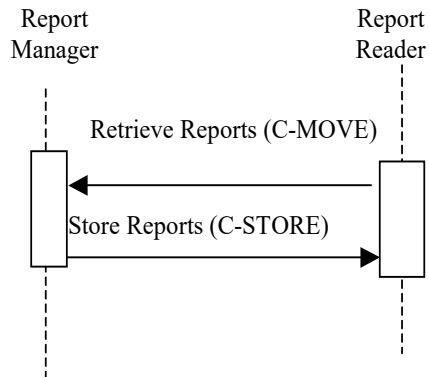

6540 **4.27.4.1 Retrieve Reports**

This transaction relates to the retrieve section of the above interaction diagram. The Retrieve (Study Root – MOVE and optionally Patient Root – MOVE) SOP Classes shall be supported. The Report Reader and Imaging Document Consumer as an SCP shall support the DICOM Basic Text SR Storage SOP Class and optionally the DICOM Enhanced SR Storage SOP Class. The Report Manager, Imaging Document Source and the Report Repository as an SCU shall support both the DICOM Basic Text SR Storage SOP Class and the DICOM Enhanced SR Storage SOP Class. The External Report Repository Access as an SCU shall support the DICOM Basic Text SR Storage SOP Class and optionally the DICOM Enhanced SR Storage SOP Class. Refer to DICOM PS 3.4, Annex C, for detailed descriptive semantics.

6550 **4.27.4.1.1 Trigger Events**

The user at the Report Reader or Imaging Document Consumer selects specific reports to view.

4.27.4.1.2 Message Semantics

The DICOM Query/Retrieve SOP Classes and the DICOM Structured Report Storage SOP Classes define the message semantics.

6555 A C-MOVE Request from the DICOM Study Root Query/Retrieve Information Model – MOVE SOP Class or the DICOM Patient Root Query/Retrieve Information Model – MOVE SOP Class shall be sent from the Report Reader to the Report Manager, Report Repository or External Report Repository Access, or from the Imaging Document Consumer to the Imaging Document Source.

4.27.4.1.3 Expected Actions

6560 The Report Manager, Report Repository, Imaging Document Source or External Report Repository Access receives the C-MOVE request, establishes a DICOM association with the Report Reader or Imaging Document Consumer and uses the appropriate DICOM Structured Report Storage SOP Classes (Basic Text SR Storage SOP Class and/or Enhanced SR Storage SOP Class) to transfer the requested reports.

6570 Report Repository responds to the queries with the information from the DICOM instances it received from the Report Manager. Typically, Report Manager will apply information updates to the instances of reports it holds and re-issue the reports to the Report Repository. To properly update the content of instances that are no longer present on the Report Manager, the update shall be performed by retrieval and re-submission of the report through the Report Manager. It may also be done by grouping the Report Repository and Report Manager.

4.27.4.2 View Reports

This transaction relates to the “View Reports” event of the above interaction diagram.

4.27.4.2.1 Trigger Events

6575 The Report Reader or Imaging Document Consumer receives reports from the Report Repository, Imaging Document Source or External Report Repository Access.

4.27.4.2.2 Invocation Semantics

6580 This is a local invocation of functions at the Report Reader or Imaging Document Consumer, and the method used by the Report Reader or Imaging Document Consumer to interpret and display the report data in a meaningful way is outside the scope of the IHE Radiology Technical Framework. At a minimum the Report Reader or Imaging Document Consumer shall be able to correctly display reports defined in RAD TF-1: 9.4. The Report Reader or Imaging Document Consumer shall be able to display reports based on the Simple Image Report (RAD TF-1: 9.4.1). If the Report Reader or Imaging Document Consumer supports the Enhanced SR Information Object Definition then it shall also support display of Simple Image and Numeric Reports (RAD TF-1: 9.4.2). Even though the IHE Technical Framework sets boundaries on the complexity of SR objects, the Report Reader or Imaging Document Consumer must still be able to receive, store and view any Basic Text SR object and optionally any Enhanced SR object in order to

6590 conform to the DICOM Standard. An implementation may not be able to render, in a meaningful way, reports more complex than those specified in RAD TF-1: 9.4.

If a DICOM Structured Report references other DICOM composite objects, such as images, and softcopy presentation states, it is optional for the Report Reader or Imaging Document Consumer to actually retrieve and display/apply these objects, but the Report Reader or Imaging Document Consumer must convey to the user that such references exist in the report.

6595 **4.27.4.2.2.1 Retrieve AE Title**

6600 If the Report Reader is grouped with an Image Display and capable of retrieving objects referenced in a DICOM Structured Report then the Report Reader shall retrieve these objects from the device matching the appropriate Retrieve AE Title attribute (0008,0054) included in the DICOM Structured Report. If the Retrieve AE Title attribute is not specified or configured, then the Report Reader may use some other configurable Retrieve AE Title.

6605 In the case of retrieving reports in a Cross-Enterprise, imaging document sharing (XDS-I) network environment, a configuration of mapping the AE Titles to DICOM AE Network Addresses (IP Address and Port number) are needed to be exchanged between the Imaging Document Source and the Imaging Document Consumer. RAD TF-3: Appendix G describes in details the AE Title mapping to the DICOM AE Network Addresses.

4.27.4.2.3 Expected Actions

The Report Reader or Imaging Document Consumer presents to the user a DICOM Structured Report.

6610 **4.28 Structured Report Export [RAD-27]**

This section corresponds to Transaction RAD-28 of the IHE Technical Framework. Transaction RAD-28 is used by the Report Manager and Enterprise Report Repository Actors.

4.28.1 Scope

6615 In the Structured Report Export transaction, the Report Manager transmits verified Structured Reports as unsolicited HL7 observations to the Enterprise Report Repository. The Report Manager is responsible for mapping DICOM SR to HL7. The Structured Report mapping to the Structured Report Export is defined later in this section.

6620 The report data transmitted in the HL7 message shall be simple ASCII text. The Report Manager shall provide a presentation of the Structured Report consistent with the semantics of the content of the Structured Report and the limitations of ASCII-based rendering.

Due to a wide variety of output devices at the final destination of the HL7 message, special formatting characters shall be avoided. For proper column alignment, the Report Manager shall use space characters as appropriate, since “tab” and other special characters may not be valid, or have inconsistent meaning on the eventual display device.

6625 **4.28.2 Use Case Roles**

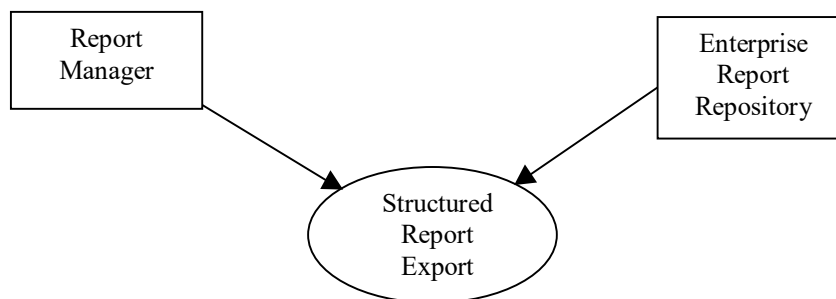

Actor: Report Manager

Role: Export verified text results to Enterprise Report Repository. This involves mapping DICOM SR terminology to HL7 terminology.

6630 **Actor:** Enterprise Report Repository

Role: Accept and store HL7 results transmitted by the Report Manager.

6635 **4.28.3 Interaction Diagram**

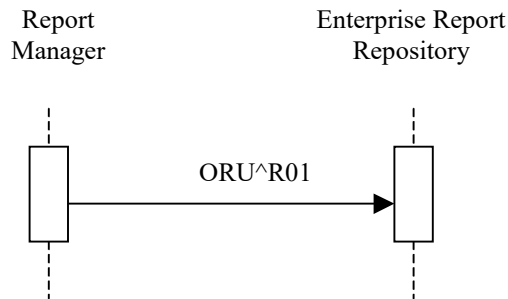

4.28.3.1 Structured Report Export

6640 This transaction relates to the ORU event between the Report Manager and the Enterprise Report Repository in the above interaction diagram.

4.28.3.1.1 Trigger Events

When DICOM Structured Reports are verified and finalized by the Report Manager, the Report Manager sends unsolicited ORU transactions to the Enterprise Report Repository.

6645 **4.28.3.1.2 Message Semantics**

Refer to the HL7 2.3.1 Standard, Chapter 7 ORU message, for general message semantics.

ORU	Structured Report Export	Chapter in HL7 2.3.1
MSH	Message Header	2
PID	Patient Identification	3
[PV1]	Patient Visit	3 (see note)
OBR	Order detail	7
{OBX}	Observation Results	7

Note: PV1 is required if use of PV1-19 Visit Number is required per the applicable regional or national extensions to the IHE Technical Framework (See RAD TF-4)

6650 The following tables provide field-by-field definitions of the required segments of the ORU message of the Structured Report Export transaction. These tables shall be interpreted according to the HL7 Standard unless otherwise specified in notes beneath the tables.

Table 4.28-1: IHE Profile - MSH segment

SEQ	LEN	DT	OPT	TBL#	ITEM #	ELEMENT NAME
1	1	ST	R		00001	Field Separator
2	4	ST	R		00002	Encoding Characters
3	180	HD	R		00003	Sending Application
4	180	HD	R		00004	Sending Facility
5	180	HD	R		00005	Receiving Application
6	180	HD	R		00006	Receiving Facility
9	7	CM	R		00009	Message Type
10	20	ST	R		00010	Message Control ID
11	3	PT	R		00011	Processing ID
12	60	VID	R	0104	00012	Version ID
18	6	ID	C	0211	00692	Character Set

6655

Adapted from the HL7 Standard, version 2.3.1

The IHE Technical Framework requires that applications support HL7-recommended values for the fields MSH-1 Field Separator and MSH-2 Encoding Characters.

6660

Field MSH-9 Message Type shall have at least two components. The first component shall have a value of “ORU”; the second component shall have the value of “R01”. Implementations supporting sequence number protocol shall be configurable to allow them to perform this transaction without such protocol.

Table 4.28-2: IHE Profile - PID segment

SEQ	LEN	DT	OPT	TBL#	ITEM#	ELEMENT NAME
3	20	CX	R		00106	Patient Identifier List
5	48	XPN	R		00108	Patient Name
7	26	TS	R2		00110	Date/Time of Birth
8	1	IS	R2	0001	00111	Sex
10	80	CE	R2	0005	00113	Race
11	106	XAD	R2		00114	Patient Address
18	20	CX	C		00121	Patient Account Number

Adapted from the HL7 standard, version 2.3.1

Table 4.28-3: IHE Profile – PV1 segment

SEQ	LEN	DT	OPT	TBL#	ITEM#	ELEMENT NAME
2	1	IS	R	0004	00132	Patient Class
19	20	CX	C		00149	Visit Number
51	1	IS	C	0326	01226	Visit Indicator

6665

Adapted from the HL7 standard, version 2.3.1

At least one of the fields *PID-18 Patient Account Number* or *PVI-19 Visit Number* shall be valued. Additional requirements for the presence of value in these fields may be documented in regional or national extensions to the IHE Radiology Technical Framework (See RAD TF- 4).

6670 Field *PVI-51 Visit Indicator* shall be valued with value “V” if the field *PVI-19 Visit Number* is present. May be omitted otherwise.

Table 4.28-4: IHE Profile - OBR Segment

SEQ	LEN	DT	OPT	TBL#	ITEM #	ELEMENT NAME
1	4	SI	R		00237	Set ID - OBR
2	22	EI	R		00216	Placer Order Number
3	22	EI	R		00217	Filler Order Number
4	200	CE	R		00238	Universal Service ID
7	26	TS	R		00241	Observation Date/Time
25	1	ID	R	0123	00258	Result Status

Adapted from the HL7 Standard, version 2.3.1

Table 4.28-5: IHE Profile - OBX Segment

SEQ	LEN	DT	OPT	TBL#	ITEM#	ELEMENT NAME
1	4	SI	R		00569	Set ID - OBX
2	3	ID	R	0125	00570	Value Type
3	80	CE	R		00571	Observation Identifier
4	20	ST	C		00572	Observation Sub-ID, See Note.
5	65536 ⁴	*	R		00573	Observation Value – may be image directory reference
11	1	ID	R	0085	00579	Observe Result Status

Adapted from the HL7 Standard, version 2.3.1

6675 Note: OBX-4 is conditional based on the OBX segment being populated. See Table 4.28-8 for conditions on the OBX-4 field.

4.28.4 DICOM SR to Structured Report Export Mapping

6680 This section defines the mapping of the content of a DICOM SR object (which is the DICOM Enhanced SR Service class) to the HL7 Report Observation message. This message is the HL7 ORU message.

Mappings between HL7 and DICOM are illustrated in the following manner:

- Element Name (HL7 item # - DICOM tag)

⁴ The length of the observation value field is variable, depending upon value type. See *OBX-2-value type*.

- Only required, R, conditionally required, R2, and conditional, C, fields are mapped in the tables below.

6685

Table 4.28-6: DICOM SR Mapping to Structured Report Export MSH Segment

SEQ	OPT	TBL#	ITEM#	ELEMENT NAME	DICOM Description / Module	DICOM Tag	Notes
18	C		00693	Character Set	Specific Character Set	0008,0005	

Table 4.28-7: DICOM SR Mapping to Structured Report Export PID Segment

SEQ	OPT	TBL#	ITEM#	ELEMENT NAME	DICOM Description / Module	DICOM Tag	Notes
3	R		00106	Patient Identifier List	Patient's ID	0010,0020	
5	R		00108	Patient Name	Patient's Name	0010,0010	
7	R2		00110	Date/Time of Birth	Patient's Birth Date	0010,0030	
8	R2	0001	00111	Sex	Patient's Sex	0010,0040	
10	R2	0005	00113	Race	Ethnic Group	0010,2160	
18	R		00121	Patient Account Number			See note IHE-1

IHE-1: The Report Manager shall supply the Patient Account Number. It is assumed that the Report Manager is able to obtain the Patient Account Number value.

Table 4.28-8: DICOM SR Mapping to Structured Report Export OBR Segment

SEQ	OPT	TBL#	ITEM #	ELEMENT NAME	DICOM Description / Module	DICOM Tag	Notes
1	R		00237	Set ID – OBR			See note IHE-2
2	R		00216	Placer Order Number	SR Document General, Referenced Request Sequence	(0040,2016)	See Note IHE-4
3	R		00217	Filler Order Number	SR Document General, Referenced Request Sequence	(0040,2017)	See Note IHE-4
4	R		00238	Universal Service ID			See Note IHE-3
7	R		00241	Observation DateTime	SR Content Observation DateTime if present, otherwise use the SR Document General, Content Date, Content Time	(0040,A032) or (0008,0023) (0008,0033)	
25	R		00258	Result Status = F			
32	O		00264	Principal Results Interpreter	Person Name value of the Content item that is related to the root of the SR document with the relationship HAS OBS	(0040,A123)	

SEQ	OPT	TBL#	ITEM #	ELEMENT NAME	DICOM Description / Module	DICOM Tag	Notes
					CONTEXT and whose Concept Name Code is (121008,DCM, "Person Observer Name")		

6690 IHE-2: If the SR has multiple items in the Referenced Request sequence, the Report Manager will generate separate ORU messages for each item.

IHE-3: The Report Manager shall supply the Universal Service ID from the original order (Placer). It is assumed that the Report Manager is able to obtain the Universal Service ID value.

6695 IHE-4: If the Placer and/or Filler order number are not provided by the Referenced Request Sequence, it is assumed that the Report Manager is able to obtain values.

Table 4.28-9: DICOM SR Mapping to Structured Report Export OBX Segments

SEQ	OPT	TBL#	ITEM#	ELEMENT NAME	DICOM Description / Module	DICOM Tag	Notes
<i>The first OBX segment carries the Structured Report Instance UID</i>							
1	R			Set-ID-OBX = 1			
2	R	0125	00070	Value Type = HD			
3	R		00571	Observation Identifier = ^SR Instance UID			
5	R		00573	Observation Value	SR Instance UID	0008,0018	
11	R		0085	Observe Result Status=F			
<i>The next set of four OBX segments repeats for each IMAGE type Content Item present in the SR content. Each OBX set provides the external report repository the ability to lookup the relevant image references.</i>							
<i>The Content Items only provide the Referenced SOP Class UID (0008,1150) and Referenced SOP Instance UID (0008,1155). The Study Instance UID (0020,000D) and Series Instance UID (0020,000E) are found in the corresponding item in the Current Requested Procedure Evidence Sequence (0040,A375) or the Pertinent Other Evidence Sequence (0040,A385). Use the SOP Instance UID to find the correct sequence item. For further details, see Table C.17-2 (SR Document General Module Attributes) and Table C.17-3 (SOP Instance Reference Macro Attributes) in Part 3 of the DICOM Standard.</i>							
<i>Each set of four OBX segments that make up an UID reference will have the same unique Observation Sub-ID (OBX 4). The Sub-ID for the first set shall have a value of 1. The Sub-ID shall increment for each subsequent OBX set in the message.</i>							
1	R			Set-ID-OBX			
2	R	0125	00070	Value Type = HD			
3	R		00571	Observation Identifier = ^Study Instance UID			
5	R		00573	Observation Value	Current/Pertinent Evidence Sequence, matching item's Study Instance UID	0020,000D	
11	R		0085	Observe Result Status=F			
1	R			Set-ID-OBX			
2	R	0125	00070	Value Type = HD			
3	R		00571	Observation Identifier = ^Series Instance UID			
5	R		00573	Observation Value	Current/Pertinent Evidence Sequence,	0020,000E	

SEQ	OPT	TBL#	ITEM#	ELEMENT NAME	DICOM Description / Module	DICOM Tag	Notes
					matching item's Series Instance UID		
11	R		0085	Observe Result Status=F			
1	R			Set-ID-OBX			
2	R	0125	00070	Value Type			
3	R		00571	Observation Identifier = ^SOP Instance UID			
5	R		00573	Observation Value	IMAGE Content Item, Referenced SOP Instance UID	0008,1155	
11	R		0085	Observe Result Status=F			
1	R			Set-ID-OBX			
2	R	0125	00070	Value Type = HD			
3	R		00571	Observation Identifier = ^SOP Class ID			
5	R		00573	Observation Value	Image Content Item, Referenced SOP Class UID	0008,1150	
11	R		0085	Observe Result Status=F			
<i>The report text generated by the Report manager is sent in the next OBX segment(s). No contextual information shall be assumed if multiple OBX segments are used.</i>							
1	R			Set-ID-OBX			
2	R	0125	00070	Value Type = TX			
3	R		00571	Observation Identifier = ^SR Text			
5	R		00573	Observation Value	Report Text from SR Object		
11	R		0085	Observe Result Status=F			

4.28.5 Expected Actions

The Enterprise Report Repository accepts the message. The usage of the result by the Enterprise Report Repository is beyond the scope of the IHE Radiology Technical Framework

6700

4.29 Key Image Note Stored [RAD-29]

This section corresponds to Transaction RAD-29 of the IHE Technical Framework. Transaction RAD-29 is used by the Acquisition Modality and Evidence Creator Actors.

4.29.1 Scope

6705 In the Key Image Note Stored transaction, the Acquisition Modality or the Evidence Creator transmits a DICOM Key Image Note, which is stored in the Image Archive.

4.29.2 Use Case Roles

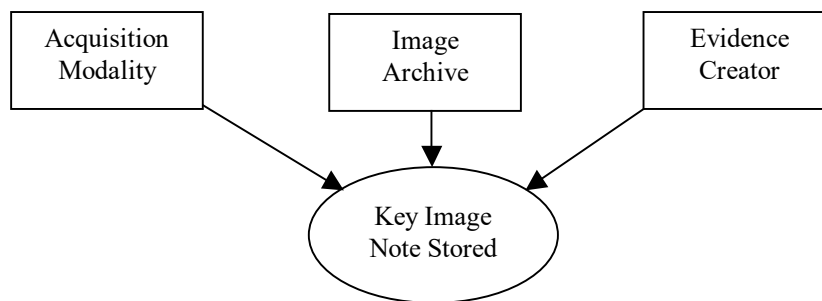

Actor: Acquisition Modality

6710 **Role:** Flag significant images by creating Key Image Notes and issuing Key Image Note Stored Transactions to the Image Archive.

Actor: Evidence Creator

Role: Flag significant images by creating Key Image Notes and issuing Key Image Note Stored Transactions to the Image Archive.

6715 **Actor:** Image Archive

Role: Accepts and Stores Key Image Note Instances received from the Acquisition Modality or Evidence Creator. This transaction describes the role related only to storage of the Key Image Note.

4.29.3 Referenced Standards

6720 DICOM PS 3.4: Key Object Selection Document Storage SOP Class

DICOM PS 3.4: Storage SOP Class

4.29.4 Interaction Diagram

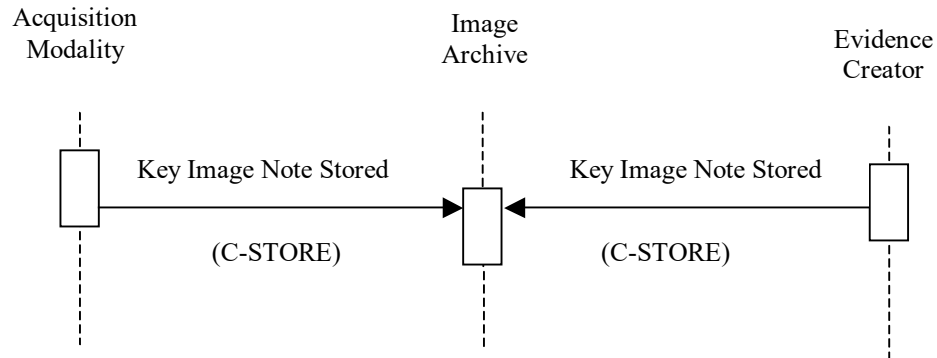

4.29.4.1 Key Image Note Stored

6725 This transaction relates to the “DICOM C-STORE” event between the Acquisition modality or the Evidence Creator and the Image Archive in the above interaction diagram.

4.29.4.1.1 Trigger Events

The Acquisition Modality or the Evidence Creator generates a Key Image Note and sends it to the Image Archive for storage.

6730 4.29.4.1.2 Message Semantics

The Acquisition Modality or the Evidence Creator uses the DICOM C-STORE message to store Key Image Notes. Message semantics are defined in the Key Object Selection Storage SOP Class definition and Behavior section of DICOM PS 3.3 and PS 3.4.

6735 Key Object Selection Documents that reference multi-frame images shall populate the Referenced Frame Number (0008,1160) in each applicable occurrence of the Referenced SOP Sequence (0008,1199) in the Key Object Selection Document, unless the Key Object Selection Document applies to all the frames in the image.

4.29.4.1.3 Expected Actions

6740 The Image Archive will store the received Key Image Note objects.

4.30 Query Key Image Notes [RAD-30]

This section corresponds to Transaction RAD-30 of the IHE Technical Framework. Transaction RAD-30 is used by the Image Archive and Image Display Actors.

4.30.1 Scope

6745 This section describes the sequence of Transactions required for the Image Display to query the Image Archive for instances of Key Image Notes. The Image Display will query (in order to later retrieve) for Key Image Note objects together with the image objects referenced in the return keys supplied in the response from the Image Archive.

Multiple Key Image Notes may exist that reference the same image data.

6750

4.30.2 Use Case Roles

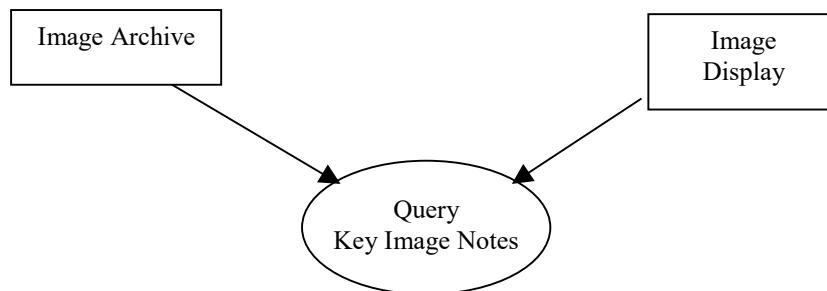

Actor: Image Display

6755 **Role:** Query for Key Image Notes objects together with the referenced image data and provides a means to indicate that images are flagged as significant. This device will implement the Query/Retrieve SOP Classes in the role of SCU.

Actor: Image Archive

Role: Respond to queries from the Image Display for Key Image Notes objects. This device will implement the Query/Retrieve SOP Classes in the role of SCP.

6760 4.30.3 Referenced Standards

DICOM PS 3.4: Query/Retrieve Service Class

DICOM PS 3.4: Key Object Selection Document Storage SOP Class

4.30.4 Interaction Diagram

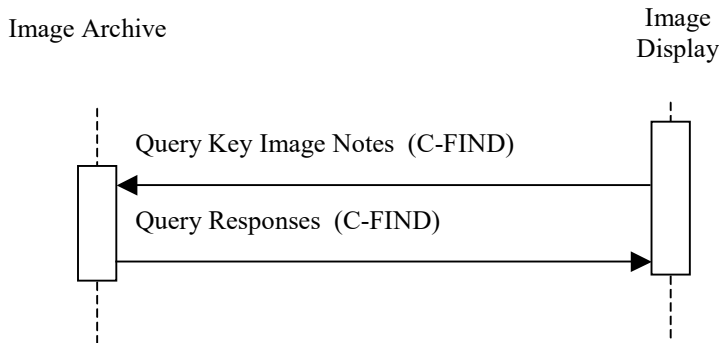

6765 **4.30.4.1 Query Key Image Notes**

This transaction relates to the query section of the above interaction diagram. The Query (Study Root – FIND and optionally Patient Root – FIND) SOP Classes shall be supported. Refer to DICOM PS 3.4: Query/Retrieve Service Class for detailed descriptive semantics.

4.30.4.1.1 Trigger Events

6770 The user at the Image Display wishes to view Key Image Notes to use as a guide to find significant images. An Image Display may query for Key Image Notes when a new patient is loaded in order to perform internal logic.

4.30.4.1.2 Message Semantics

The message semantics are defined by the DICOM Query/Retrieve SOP Classes.

6775 A C-FIND Request from the DICOM Study Root Query/Retrieve Information Model – FIND SOP Class or the DICOM Patient Root Query/Retrieve Information Model – FIND SOP Class shall be sent from the Image Display to the Image Archive.

The Image Display uses one or more matching keys as search criteria to obtain the list of matching entries in the Image Archive at the selected level (Patient & Study/Series/Instance).

6780 In addition to the required and unique keys defined by the DICOM Standard, the IHE Technical Framework has defined matching and return keys to be supported by query SCUs and SCPs. The keys are defined in Section 4.14.4.1.2 and Table 4.14-1. The conventions for key usage are defined in Section 2.2. For the Image Display (SCU) and the Image Archive (SCP) the additional Key Image Note Instances specific keys are defined in Table 4.30-1.

6785 **Table 4.30-1: Key Image Note Instance Specific Query Matching and Return Keys**

Attribute Name	Tag	Query Keys Matching		Query Keys Return	
		SCU	SCP	SCU	SCP
Key Instance Note Instance Specific Level					
Content Date	(0008,0023)	O	O	O	R+
Content Time	(0008,0033)	O	O	O	R+

Attribute Name	Tag	Query Keys Matching		Query Keys Return	
		SCU	SCP	SCU	SCP
Observation DateTime	(0040,A032)	O	O	O	R+
Referenced Request Sequence	(0040,A370)				
>Study Instance UID	(0020,000D)	O	O	R+*	R+
>Accession Number	(0008,0050)	O	O	R+	R+
>Requested Procedure ID	(0040,1001)	O	O	R+	R+
>Requested Procedure Code Sequence	(0032,1064)				
>>Code Value	(0008,0100)	O	O	O	R+
>>Coding Scheme Designator	(0008,0102)	O	O	O	R+
>>Coding Scheme Version	(0008,0103)	O	O	O	R+
>>Code Meaning	(0008,0104)	O	O	O	R+
Concept Name Code Sequence (Note 1)	(0040,A043)				
>Code Value	(0008,0100)	R+	R+	R+	R+
>Coding Scheme Designator	(0008,0102)	R+	R+	R+	R+
>Coding Scheme Version	(0008,0103)	O	O	O	R+
>Code Meaning	(0008,0104)	O	O	R+	R+

Note1: The Concept Name Code Sequence of the root content item conveys the Key Image Note Title. The list of applicable codes can be found in CID 7010 (Key Object Selection Document Title) in DICOM PS 3.16.

4.30.4.1.3 Expected Actions

6790 The Image Archive receives the C-FIND request, performs the matching on the provided keys and sends the list of matching records back to the Image Display via C-FIND responses.

The Image Archive participating in the Mammography Acquisition Workflow Integration Profile or Imaging Object Change Management Integration Profile shall include or not include matching records related to specific KOS instances that mark rejected or corrected images as defined in RAD TF-3: 4.66.4.1.3 and 4.66.4.2.3.

6795 Note: Mammography Acquisition Workflow Integration Profile is currently in Trial Implementation. Please refer to the supplement for details.

The Image Archive participating in the Imaging Object Change Management Integration Profile shall also include or not include matching records related to specific KOS instances that mark rejected or corrected images as defined in RAD TF-3: 4.66.4.3.3 and 4.66.4.4.3.

6800

4.31 Retrieve Key Image Notes [RAD-31]

This section corresponds to Transaction RAD-31 of the IHE Technical Framework. Transaction RAD-31 is used by the Image Display and Image Archive Actors or Imaging Document Consumer and Imaging Document Source.

6805 4.31.1 Scope

In the Retrieve Key Image Notes Transaction, the requested DICOM Key Image Notes are transferred from the Image Manager or Imaging Document Source to the Image Display or Imaging Document Consumer for viewing along with the images flagged by the Key Image Note.

6810 4.31.2 Use Case Roles

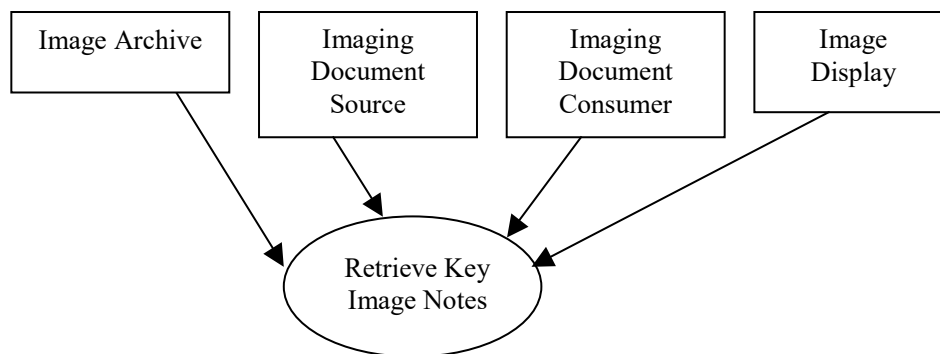

Actor: Image Archive

Role: Sends requested Key Image Notes to the Image Display.

Actor: Imaging Document Source

6815 **Role:** Sends requested Key Image Notes to the Imaging Document Consumer.

Actor: Image Display

Role: Receives requested Key Image Notes from the Image Archive.

Actor: Imaging Document Consumer

Role: Receives requested Key Images Notes from the Imaging Document Source.

6820

4.31.3 Referenced Standards

DICOM PS 3.4: Query/Retrieve Service Class

DICOM PS 3.4: Key Object Selection Document Storage SOP Class

4.31.4 Interaction Diagram

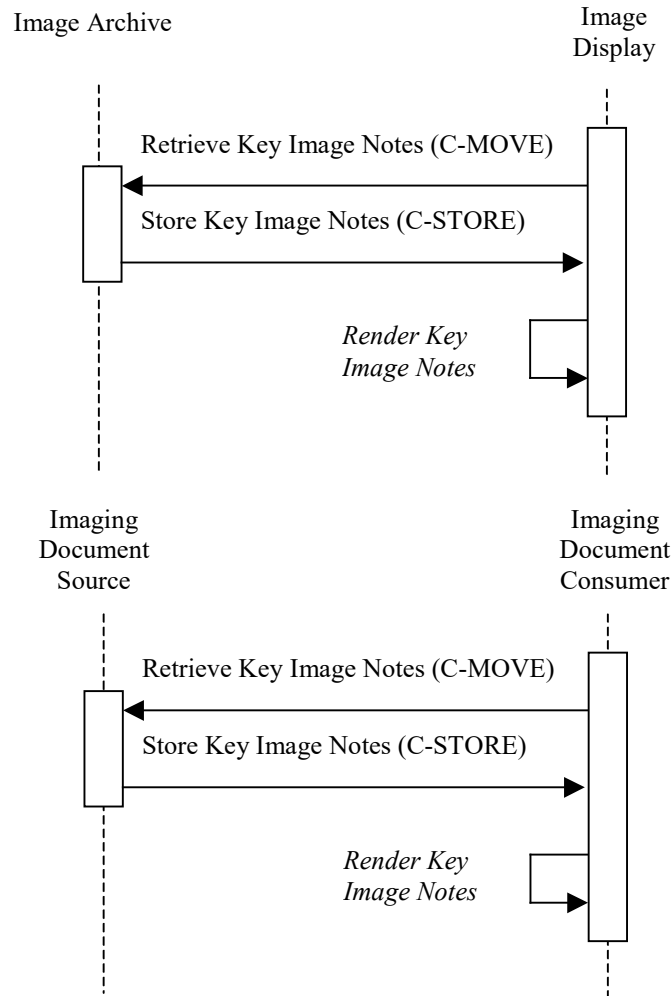

6825

4.31.4.1 Retrieve Key Image Notes

The Retrieve (Study Root – MOVE and optionally Patient Root – MOVE) SOP Classes will be supported. The Image Archive and Imaging Document Source as an SCU shall support DICOM Image Storage SOP Classes. Refer to DICOM PS 3.4, Annex C, for detailed descriptive semantics.

6830

4.31.4.1.1 Trigger Events

The Image Display or Imaging Document Consumer selects specific Key Image Note objects to retrieve from the Image Archive or Imaging Document Source.

4.31.4.1.2 Message Semantics

6835 The message semantics are defined in the DICOM Query/Retrieve Service Class. It is the
responsibility of the Image Manager to assure that the patient and procedure information is
current in the images and Key Image Note objects when they are retrieved from the Image
Archive. It is the responsibility of the Imaging Document Source to assure that the patient and
6840 procedure information is current in the Key Image Note objects when they are retrieved from this
actor.

4.31.4.1.3 Expected Actions

The Image Archive or Imaging Document Source receives the C-MOVE request, establishes a
DICOM association with the Image Display or Imaging Document Consumer, and uses the
DICOM Key Image Note Storage SOP Class to transfer the requested Key Image Note objects.

6845 The Image Archive participating in the Mammography Acquisition Workflow Integration Profile
or Imaging Object Change Management Integration Profile shall include or not include specific
KOS instances that mark rejected images as defined in RAD TF-3: 4.66.4.1.3.

Note: Mammography Acquisition Workflow Integration Profile is currently in Trial Implementation. Please refer to the
supplement for details.

6850 4.31.4.2 Render Key Image Notes

This transaction relates to the “Render Key Image Notes” event of the above interaction diagram.
Key Image Notes cannot be rendered separately, but must be applied to images. Refer to Section
4.16 for a description of the transaction used to retrieve images to which Key Image Notes may
be applied.

6855 The Image Display or Imaging Document Consumer is not required to, but may choose to,
support retrieval and display of images from other studies than the one to which the Key Image
Note belongs.

4.31.4.2.1 Trigger Events

6860 The Image Display or Imaging Document Consumer receives Key Image Note instances from
the Image Archive or Imaging Document Source.

4.31.4.2.2 Invocation Semantics

6865 This is a local invocation of functions resident within the Image Display or Imaging Document
Consumer. The method used by the Image Display or Imaging Document Consumer to present
images for viewing by the user flagged by the Key Image Notes is outside the scope of the IHE
Radiology Technical Framework.

4.31.4.2.2.1 Retrieve AE Title

If the Image Display is capable of retrieving objects referenced in a DICOM Key Image Note
then it shall retrieve these objects from the device matching the appropriate Retrieve AE Title
attribute (0008,0054) included in the DICOM Key Image Note. If the Retrieve AE Title attribute

6870 is not specified or configured, then the Image Display shall use some other configurable Retrieve AE Title.

In the case of retrieving DICOM Key Image Notes in a Cross-Enterprise, imaging document sharing (XDS-I) network environment, a configuration of mapping the AE Titles to DICOM AE Network Addresses (IP Address and Port number) are needed to be exchanged between the
6875 Imaging Document Source and the Imaging Document Consumer. RAD TF-3: Appendix G describes in details the AE Title mapping to the DICOM AE Network Addresses.

4.31.4.2.3 Expected Actions

The Image Display or Imaging Document Consumer flags the images and renders the Key Image Note.

6880 Note: It is recommended to use the just retrieved instance of the Key Image Note to ensure that the most recent patient data be displayed to reflect possible patient merge and patient update in the Image Manager/Image Archive or Imaging Document Source. This patient data may be inconsistent with patient data contained in a previously retrieved copy of the same Key Image Note instance.

4.31.4.2.3.1 Presentation of rejected or incorrect images in Mammography Acquisition Workflow

6885

Intentionally left blank.

4.31.4.2.3.2 Presentation of rejected or incorrect images in Imaging Object Change Management

6890 An Image Display participating in the Imaging Object Change Management Integration Profile may receive Key Image Notes.

When an Image Display receives a Key Image Note with Key Object Selection (KOS) Document Title valued (113001, DCM, "Rejected for Quality Reasons"). The Image Display shall support the three behaviors listed below. The behavior shall be configurable as one of the following:

- 6895 • Suppress from presentation the rejected instances referenced in this KOS and this KOS itself
- Present the rejected instances referenced in this KOS and this KOS itself
- Ignore this KOS and present the rejected instances.
- 6900 • When an Image Display receives a Key Image Note with the Key Object Selection (KOS) Document Title valued (113037, DCM, "Rejected for Patient Safety Reasons"), (113038, DCM, "Incorrect Modality Worklist Entry"), or (113039, DCM, "Data Retention Policy Expired"), it shall suppress the KOS and its referenced rejected instances from presentation.

6905 **Appendix A: Attribute Consistency between Modality Worklist, Composite IODs, Evidence Documents, KIN and Modality Performed Procedure Step**

This appendix is an integral part of the IHE Technical Framework. It reflects IHE’s adoption of DICOM-defined attribute consistency (Annex J, PS.3.17, since DICOM 2006; before: Annex M, PS 3.4). It includes four sections:

- 6910 • The first section contains the IHE clarifications, additions and a summary of DICOM, PS.3.17, Annex J that relate to *image acquisition*. IHE requires that Modality Actors support the Attribute mapping defined in this table as they implement MWL, various IOD Storage and PPS SOP Classes for transactions RAD-6, RAD-7, RAD-20 and RAD-21. IHE restates or extends some of the DICOM requirements as well as select some of the choices offered or enforce some of the recommendations of DICOM. A few additional IHE recommendations are also specified.
- 6915 • The second section defines attribute mappings for consistency in DICOM SR-based *evidence objects* generated by the Evidence Creator and Acquisition Modality. The DICOM SR objects are created based on existing images that provide values to be filled into the new evidence documents.
- 6920 • The third section defines additional IHE requirements for *consistency of DICOM C-FIND Return Key Attributes*.
- 6925 • The fourth section introduces a *real-world data model* of the entities and their Attributes related to consistency. Readers are advised to use this data model along with the information presented in RAD TF-1: 3.4. This data model is provided only for ease of understanding and does not introduce any additional IHE requirements.

A.1: Image Acquisition Integration-critical Attributes

6930 The tables below describe requirements, recommendations or explanations on integration-critical attributes for image acquisition cases. They define which integration-critical attributes need to be equal (copied or generated locally), in order to correctly relate scheduled and performed procedure steps for the PPS cases described in Section 4.6.4.1.2.3.

General table structure:

- 6935 • The 1st column denotes the DICOM attributes whose values shall be mapped between the DICOM objects (equal values in the same table row). The DICOM attribute tag is indicated for clarity.
- The 2nd to 4th columns define where attribute values come from: all defined attribute values of one table row are equal. These columns read left to right: MWL return values (2nd column), if existing, shall be used as the source for copies to Image/ Standalone or MPPS IODs.

- 6940
- The MWL column is omitted if the described case does not include any MWL return values, or to simplify the table (as in the Append Case in Table A.1-3 or the PGP with Group Case in Table A.1-5).

Cell content conventions:

- 6945
- “**Source**” in a table cell means that the DICOM object defined in the table column (e.g., MWL) and created by one actor shall be the source of this value for the DICOM attribute for *another* actor to fill in this value for their own objects (e.g., Image or MPPS).
 - “**Copy**” in a table cell means that the value shall be copied from a corresponding source attribute of another DICOM object, as defined by the table column.
 - “**Copy from: <DICOM attribute>**” means that, instead of using the DICOM attribute of the same row as the source, the source as specified in the referenced DICOM attribute shall be used.
 - “**Equal**” in a table cell means that an actor already knows the value, e.g., from some previously performed action. Thus, the circumstances of value generation do not matter.
 - “**Equal (internally generated)**” in a table cell means that an actor has internally generated a value that may be used in more than one DICOM object, without having obtained this value from another actor (i.e., no copy).
 - “**Equal (copied from MWL)**” in a table cell means that the actor shall use a value that it already knows from an MWL query result obtained for the same SPS in the append case.
 - “**Source-1**”, “**Copy-1**” or “**Equal-1**” etc. are corresponding mapping attribute values, if several sources appear in one table row.
 - “**See (IHE-X)**” in a table cell denotes additional requirements, recommendations or explanations for the attribute value, as described in the table’s note “(IHE-X)”. Otherwise, brief text that fits into a table cell is presented in the cell.
 - “**n.a.**” in a table cell means that such an attribute or value shall not exist. Either the attribute is not defined by the DICOM standard for this object, or the particular sequence attribute is a DICOM type 3 attribute, and DICOM requires at least one sequence item to be present.
- 6950
- 6955
- 6960
- 6965

Actor behavior:

- 6970
- An attribute from the column “Modality Worklist” shall be requested by a MWL SCU (Acquisition Modality) as a return key in its C-FIND Requests. The Department System Scheduler shall return attribute values in the Modality Worklist C-FIND response (for a complete description, see Table 4.5-3).
 - The MWL return attribute values, if available as a source, shall be used by the Acquisition Modality in filling the attribute shown on the corresponding rows both for Composite Instances and MPPS Instances.
- 6975

- If the MWL value is not existing (“n.a.”), then the Modality shall generate certain values internally.
- The PPS Manager, Image Manager and Department System Scheduler roles shall be capable of handling the attributes shown in the corresponding row of the column titled “MPPS IOD” as defined by the SCP Type and the additional notes.
- The Department System Scheduler shall copy the value of the Study Instance UID from the Procedure Scheduled Message (Section 4.4.4.1) ZDS-1 (HL7 v2.3.1 Message Semantics) or IPC-3 (HL7 v2.5.1 Message Semantics) into the SOP Instance UID (0008,1155) attribute of the single Item of the Referenced Study Sequence (0008,1110). The SOP Class UID of such an Item shall be “1.2.840.10008.3.1.2.3.2”.
- An empty Referenced Study Sequence (0008,1110) in a MPPS Instance indicates an unscheduled case (no Scheduled Procedure Step involved).

6980

6985

6990

Note: The values of an Item of the Referenced Study Sequence (0008,1110) shall not be used to query/retrieve a SOP Instance of the Detached Study Management (retired) as is the intention of this sequence in the DICOM Standard. The use of the Detached Study Management SOP Class UID (1.2.840.10008.3.1.2.3.1) is only intended as a placeholder indicating the SOP Instance UID being the Study Instance UID.

Table A.1-1: Simple Case - required mapping of corresponding attributes

In the simple normal case, a Procedure Step is performed

6995

- exactly as scheduled, or
- different than scheduled, but without being rescheduled, e.g., due to a patient’s allergic reaction to contrast media.

DICOM attribute	Modality Worklist (return attribute values)	Filling values for:	
		Image/ Standalone IOD	MPPS IOD
Study Instance UID (0020,000D)	Source	Copy	Copy
Referenced Study Sequence (0008,1110)	Source	Copy	Copy
Accession number (0008,0050)	Source	Copy See (IHE-A.1.1)	Copy See (IHE-A.1.1)
Requested Procedure ID (0040,1001)	Source	Request Attributes Sequence (0040,0275)	Copy
Requested Procedure Description (0032,1060)	Source		Copy
Scheduled Procedure Step ID (0040,0009)	Source		Copy
Scheduled Procedure Step Description (0040,0007)	Source		Copy
			Scheduled Step Attributes Sequence (0040,0270)

DICOM attribute	Modality Worklist (return attribute values)	Filling values for:	
		Image/ Standalone IOD	MPPS IOD
Scheduled Protocol Code Sequence (0040,0008)	Source	Copy	Copy
Performed Protocol Code Sequence (0040,0260)	n.a.	Equal (internally generated). Recommendation: Absent if the value is not known. Is non-empty if Assisted Protocol Setting Option is supported (see 4.6.4.1.2.4).	Equal (internally generated). Shall be zero length if the value is not known, e.g., Assisted Protocol Setting not supported.
Study ID (0020,0010)	n.a.	Equal (internally generated). Recommendation: use Requested Procedure ID.	Equal (internally generated). Recommendation: use Requested Procedure ID.
Performed Procedure Step ID (0040,0253)	n.a.	Equal (internally generated). See (IHE-A.1.2)	Equal (internally generated).
Performed Procedure Step Start Date (0040,0244)	n.a.	Equal (internally generated). Recommendation: use the same value for Study Date.	Equal (internally generated).
Performed Procedure Step Start Time (0040,0245)	n.a.	Equal (internally generated). Recommendation: use the same value for Study Time.	Equal (internally generated).
Performed Procedure Step Description (0040,0254)	n.a.	Equal (internally generated). Recommendation: use the same value for Study Description.	Equal (internally generated).
Requested Procedure Code Sequence (0032,1064)	Value shall be used for Procedure Code Sequence as specified below.	n.a.	n.a.
Procedure Code Sequence (0008,1032)	n.a.	Copy from: Requested Procedure Code Sequence (0032,1064). Recommendation: absent, if empty in MWL or performed acquisition is different to what was scheduled.	Copy from: Requested Procedure Code Sequence (0032,1064). Recommendation: empty, if empty in MWL or performed acquisition is different to what was scheduled.
Referenced SOP Class UID (0008,1150)	n.a.	Referenced PPS Sequence (IHE-A.1.3)	1.2.840.10008.3.1.2.3.3
Referenced SOP Instance UID (0008,1155)	n.a.		Equal to SOP Instance of the associated MPPS (IHE-A.1.5).
Protocol Name (0018,1030)	n.a.	Recommendation: equal (internally generated)	Performed Series Sequence (0040,0340) Equal (internally generated)

- 7000 • (IHE-A.1.1) A Zero Length Accession Number (One of the options proposed by DICOM PS 3.17 Annex J) shall be created when no reliable value for this attribute is available. Reliable values are those that can be conveyed by means other than manual data entry such as a value received from the Order Filler via a Modality Worklist including an Accession Number or received through a bar code reader.
- 7005 • (IHE-A.1.2) Performed Procedure Step ID is generated by the modality arbitrarily and is not necessarily unique: Two different Performed Procedure Steps may share the same ID (e.g., may have been generated by different modalities). This ID may not enable a receiving system to reliably relate the PPS to the associated Requested Procedure and SPS. It is not reliable to assume that two PPSs with the same PPS ID value fulfill the same SPS/Requested Procedure, without checking the content of Scheduled Attributes Step Sequence.
- 7010 • (IHE-A.1.3) The Referenced Performed Procedure Step Sequence (0008,1111) that contains the PPS SOP Instance UID shall be included (per DICOM PS 3.3 Section C.7.3 strong recommendation, General Series Module Table, Note 1) when Acquisition Modality Actors support MPPS.
- 7015 • (IHE-A.1.4) In MPPS, SOP Class UID is sent in the Affected SOP Class UID (0000,0002) for the PPS N-Create message and in Requested SOP Class UID (0000,0003) for the PPS N-Set message. SOP Class UID (0008,0016) shall not be used.
- 7020 • (IHE-A.1.5) In MPPS, SOP Instance UID is sent in the Affected SOP Instance UID (0000,1000) of the PPS N-Create message and in Requested SOP Instance UID (0000,1001) for the PPS N-Set message. SOP Instance UID (0008,0018) shall not be used.

Table A.1-2: Unscheduled Case - required mapping of corresponding attributes

DICOM attribute	Filling values for:		
	Image/ Standalone IOD	MPPS IOD	
Study Instance UID (0020,000D)	Equal (internally generated).		
Referenced Study Sequence (0008,1110)	n.a.	Scheduled Step Attributes Sequence (0040,0270)	
Accession number (0008,0050)	Shall be empty (zero length).		
Requested Procedure ID (0040,1001)	Request Attributes Sequence (0040,0275)		n.a.
Requested Procedure Description (0032,1060)			Shall be empty.
Scheduled Procedure Step ID (0040,0009)			Shall be empty.
Scheduled Procedure Step Description (0040,0007)			Shall be empty.
			Shall be empty.

DICOM attribute	Filling values for:	
	Image/ Standalone IOD	MPPS IOD
Scheduled Protocol Code Sequence (0040,0008)		Shall be empty.
Performed Protocol Code Sequence (0040,0260)	Equal (internally generated). Recommendation: Absent if the value is not known. Is non-empty if Assisted Protocol Setting Option is supported (see 4.6.4.1.2.4).	Equal (internally generated). Shall be zero length if the value is not known, e.g., Assisted Protocol Setting not supported.
Study ID (0020,0010)	Equal (internally generated)	Equal (internally generated)
Performed Procedure Step ID (0040,0253)	Equal (internally generated). See (IHE-A.2.1)	Equal (internally generated).
Performed Procedure Step Start Date (0040,0244)	Equal (internally generated). Recommendation: use the same value for Study Date.	Equal (internally generated).
Performed Procedure Step Start Time (0040,0245)	Equal (internally generated). Recommendation: use the same value for Study Time.	Equal (internally generated).
Performed Procedure Step Description (0040,0254)	Equal (internally generated). Recommendation: use the same value for Study Description.	Equal (internally generated).
Requested Procedure Code Sequence (0032,1064)	n.a.	n.a.
Procedure Code Sequence (0008,1032)	n.a.	Shall be empty.
Referenced SOP Class UID (0008,1150)	Referenced PPS Sequence (0008,1111) (IHE-A.2.2)	1.2.840.10008.3.1.2.3.3
Referenced SOP Instance UID (0008,1155)		Equal to SOP Instance of the associated MPPS (IHE-A.2.4).
Protocol Name (0018,1030)	Recommendation: equal (internally generated).	Performed Series Sequence (0040,0340) Equal (internally generated)

7025

- (IHE-A.2.1) Performed Procedure Step ID is generated by the modality arbitrarily and is not necessarily unique: Two different Performed Procedure Steps may share the same ID (e.g., may have been generated by different modalities).
- (IHE-A.2.2) The Referenced Performed Procedure Step Sequence (0008,1111) that contains the PPS SOP Instance UID shall be included (per DICOM PS 3.3 Section C.7.3 strong recommendation, General Series Module Table, Note 1) when Acquisition Modality Actors support MPPS.

- 7030 • (IHE-A.2.3) In MPPS, SOP Class UID is sent in the Affected SOP Class UID (0000,0002) for the PPS N-Create message and in Requested SOP Class UID (0000,0003) for the PPS N-Set message. SOP Class UID (0008,0016) shall not be used.
- 7035 • (IHE-A.2.4) In MPPS, SOP Instance UID is sent in the Affected SOP Instance UID (0000,1000) of the PPS N-Create message and in Requested SOP Instance UID (0000,1001) for the PPS N-Set message. SOP Instance UID (0008,0018) shall not be used.

Table A.1-3: Append to a Simple/ Normal Case - required mapping of corresponding attributes

7040

Similar to the simple case, the first PPS is generated in response to an SPS. Other PPSs are added at a later time, for instance due to unacceptable quality of certain images.

DICOM attribute	Filling values for:		
	Original Image/ Standalone IOD	Append Image/ Standalone IOD	Append MPPS IOD
Study Instance UID (0020,000D)	Equal (copied from MWL)	Equal (copied from MWL)	Scheduled Step Attributes Sequence (0040,0270)
Referenced Study Sequence (0008,1110)	Equal (copied from MWL)	Equal (copied from MWL)	
Accession number (0008,0050)	Equal (copied from MWL). See (IHE-A.3.1).	Equal (copied from MWL). See (IHE-A.3.1).	
Requested Procedure ID (0040,1001)	Request Attributes Sequence (0040,0275) Equal (copied from MWL)	Request Attributes Sequence (0040,0275) Equal (copied from MWL)	
Requested Procedure Description (0032,1060)	Equal (copied from MWL)	Equal (copied from MWL)	
Scheduled Procedure Step ID (0040,0009)	Equal (copied from MWL)	Equal (copied from MWL)	
Scheduled Procedure Step Description (0040,0007)	Equal (copied from MWL)	Equal (copied from MWL)	
Scheduled Protocol Code Sequence (0040,0008)	Equal (copied from MWL)	Equal (copied from MWL)	Equal (copied from MWL)
Performed Protocol Code Sequence (0040,0260)	Note: Values may not be relevant for the appended image and associated MPPS, e.g., due to adding images from an adjacent body region or from doing measurements.	Equal (internally generated). Recommendation: Absent if the value is not known. Is non-empty if Assisted Protocol Setting Option is supported (see 4.6.4.1.2.4).	Equal (internally generated). Shall be zero length if the value is not known, e.g., Assisted Protocol Setting not supported.
Study ID (0020,0010)	Equal (internally generated) Recommendation: use Requested Procedure ID.	Equal (internally generated) Recommendation: use Requested Procedure ID.	Equal (internally generated) Recommendation: use Requested Procedure ID.
Performed Procedure Step ID (0040,0253)	Note: Values not relevant for the appended image and associated MPPS.	Equal (internally generated). See (IHE-A.3.2)	Equal (internally generated).
Performed Procedure Step Start Date (0040,0244)	Note: Values not relevant for the appended image and associated MPPS.	Equal (internally generated). See (IHE-A.3.3)	Equal (internally generated).
Performed Procedure Step Start Time (0040,0245)	Note: Values not relevant for the appended image and associated MPPS.	Equal (internally generated). See (IHE-A.3.3)	Equal (internally generated).
Performed Procedure Step Description (0040,0254)	Note: Values not relevant for the appended image and associated MPPS.	Equal (internally generated). See (IHE-A.3.3)	Equal (internally generated).

DICOM attribute	Filling values for:		
	Original Image/ Standalone IOD	Append Image/ Standalone IOD	Append MPPS IOD
Requested Procedure Code Sequence (0032,1064)	n.a.	n.a.	n.a.
Procedure Code Sequence (0008,1032)	Equal. Note: May be absent (see Table A.1-1)	Equal. If absent in original image, shall be absent here. Recommendation: absent, if performed acquisition is different from the original image's procedure.	Equal. If absent in original image, shall be empty. Recommendation: empty, if absent in the original/ appended image.
Referenced SOP Class UID (0008,1150)	Referenced PPS Sequence (0008,1111) (IHE-A.3.4) Note: Values not relevant for the appended image and associated MPPS.	Referenced PPS Sequence (0008,1111) (IHE-A.3.4) 1.2.840.10008.3.1.2.3.3 Equal to SOP Instance of the associated MPPS (IHE-A.3.6).	Equal (internally generated). See (IHE-A.3.5)
Referenced SOP Instance UID (0008,1155)			Equal (internally generated). See (IHE-A.3.6)
Protocol Name (0018,1030)	Note: Values not relevant for the appended image and associated MPPS.	Recommendation: equal (internally generated).	Performed Series Sequence (0040,0340) Equal (equally generated)

- 7045 • (IHE-A.3.1) A Zero Length Accession Number (One of the options proposed by DICOM PS 3.17 Annex J) needs to be created when no reliable value for this attribute is available. Reliable values are those that can be conveyed by means other than manual data entry such as a value received from the Order Filler via a Modality Worklist including an Accession Number or received through a bar code reader.
- 7050 • (IHE-A.3.2) Performed Procedure Step ID is generated by the modality arbitrarily and is not necessarily unique: Two different Performed Procedure Steps may share the same ID (e.g., may have been generated by different modalities). This ID may not enable a receiving system to reliably relate the PPS to the associated Requested Procedure and SPS. It is not reliable to assume that two PPSs with the same PPS ID value fulfill the same SPS/Requested Procedure, without checking the content of Scheduled Attributes Step Sequence.
- 7055 • (IHE-A.3.3) In the Image IODs created in Append Case, the Study Date, Study Time and Study Description shall re-use the corresponding values from the original images to which they are appended.
- (IHE-A.3.4) The Referenced Performed Procedure Step Sequence (0008,1111) that contains the PPS SOP Instance UID shall be included (per DICOM PS 3.3 section C.7.3 strong recommendation, General Series Module Table, Note 1) when Acquisition Modality Actors support MPPS.

- 7060
- (IHE-A.3.5) In MPPS, SOP Class UID is sent in the Affected SOP Class UID (0000,0002) for the PPS N-Create message and in Requested SOP Class UID (0000,0003) for the PPS N-Set message. SOP Class UID (0008,0016) shall not be used.
 - (IHE-A.3.6) In MPPS, SOP Instance UID is sent in the Affected SOP Instance UID (0000,1000) of the PPS N-Create message and in Requested SOP Instance UID (0000,1001) for the PPS N-Set message. SOP Instance UID (0008,0018) shall not be used.
- 7065

If a PPS and related images is appended to a group case (see Section 4.6.4.1.2.3.3), e.g., for adding 3D post-processing evidence to a grouped MR head and neck exam, then the following conditions need to be considered for the appended images and MPPs, especially as compared to appending to a simple case:

- 7070
- The Study Instance UID (0020,000D) in appended images and PPS shall have the same value as the Study Instance UID generated for the original grouped images.
 - The Accession Number (0008,0050) shall be empty if the grouped SPS do not have the same Accession Number.
- 7075
- The Referenced Study Sequence (0008,1110) in appended images shall have as many sequence items as there are different grouped Requested Procedures.
 - The Request Attributes Sequence (0040,0275) in appended images shall have as many sequence items as there are grouped SPSs.
- 7080
- The Scheduled Step Attributes Sequence (0040,0270) associated with the appended images shall have as many sequence items as there are grouped SPSs.
 - Performed Protocol Code Sequence (0040,0260) will probably have different values than for the original grouped images.
 - The Procedure Code Sequence (0008,1032) in appended images and the associated MPPS is recommended to contain as many items as there are different Procedure Codes in Requested Procedures if the system is able to ensure that what is acquired is what has been scheduled. It is recommended to be absent if the Procedure Code Sequence is absent in MWL or the performed acquisition is different from what has been scheduled.
- 7085

Table A.1-4: Group Case (3 SPSs belonging to 2 Requested Procedures) - required mapping of corresponding attributes

- 7090
- This scenario describes the case where the first Requested Procedure has 1 SPS, and the second Requested Procedure contains 2 SPSs (grouping as in the diagram in Section 4.6.4.1.2.3.6). Note: For generating the append PPS to a group case, the Modality actor needs to fill in additional attributes currently not defined in DICOM, which relate to requested or scheduled information. A Correction Proposal to DICOM requests to resolve these issues by adding optional attributes to the Request Attributes Sequence in Image IODs and to the Scheduled Step Attribute Sequence in MPPS (for details see RAD TF-1: B.2.2).
- 7095

DICOM attribute	Modality Worklist (return attribute values)			Filling values for:							
	Item 1	Item 2	Item 3	Image IOD			MPPS IOD				
Study Instance UID (0020,000D)	Source-1	Source-2	Source-2	Equal (internally generated)			Scheduled Step Attributes Sequence (0040,0270)	Item 1	Item 2	Item 3	
Accession number (0008,0050)	Source-1	Source-2	Source-2	Copy (if same Accession Number in Source-1 and Source-2). Shall be empty if the grouped SPSs do not have the same Accession Number.				Equal	Equal	Equal	
Referenced Study Sequence (0008,1110)	Source-1	Source-2	Source-2	Item 1		Item 2		Copy-1	Copy-2	Copy-2	
Requested Procedure ID (0040,1001)	Source-1	Source-2	Source-2	Request Attributes Sequence (0040,0275)	Item 1	Item 2		Item 3	Copy-1	Copy-2	Copy-2
Requested Procedure Description (0032,1060)	Source-1	Source-2	Source-2		Copy-1	Copy-2		Copy-2	Copy-1	Copy-2	Copy-2
Requested Procedure Code Sequence (0032,1064)	Source-1	Source-2	Source-2		Copy-1	Copy-2		Copy-2	Copy-1	Copy-2	Copy-2
	Values shall be used for Procedure Code Sequence as specified below.				Copy-1	Copy-2		Copy-2	Copy-1	Copy-2	Copy-2
Scheduled Procedure Step ID (0040,0009)	Source-1	Source-2	Source-3	Copy-1	Copy-2	Copy-3		Copy-1	Copy-2	Copy-3	
Scheduled Procedure Step Description (0040,0007)	Source-1	Source-2	Source-3	Copy-1	Copy-2	Copy-3		Copy-1	Copy-2	Copy-3	
Scheduled Protocol Code Sequence (0040,0008)	Source-1	Source-2	Source-3	Copy-1	Copy-2	Copy-3		Copy-1	Copy-2	Copy-3	
Accession number (0008,0050)	(documented above in this column)			Copy-1	Copy-2	Copy-2	n.a.				
Study Instance UID (0020,000D)				Equal (internally generated)	Equal (internally generated)	Equal (internally generated)	n.a.				
Referenced Study Sequence (0008,1110)				Copy-1	Copy-2	Copy-2	n.a.				
Performed Protocol Code Sequence (0040,0260)	n.a.			Equal (internally generated). Recommendation: Absent if the value is not known. Is non-empty if Assisted Protocol Setting Option is supported (see 4.6.4.1.2.4).			Equal (internally generated). Shall be zero length if the value is not known, e.g., Assisted Protocol Setting not supported.				
Study ID (0020,0010)	n.a.			Equal (internally generated)			Equal (internally generated)				
Performed Procedure Step ID (0040,0253)	n.a.			Equal (internally generated). See (IHE-A.4.1)			Equal (internally generated). See (IHE-A.4.1)				

DICOM attribute	Modality Worklist (return attribute values)			Filling values for:	
	Item 1	Item 2	Item 3	Image IOD	MPPS IOD
Performed Procedure Step Start Date (0040,0244)	n.a			Equal (internally generated). Recommendation: Use the same value for Study Date	
Performed Procedure Step Start Time (0040,0245)	n.a			Equal (internally generated). Recommendation: Use the same value for Study Time	
Performed Procedure Step Description (0040,0254)	n.a			Equal (internally generated). Recommendation: Use the same value for Study Description	
Procedure Code Sequence (0008,1032)	n.a			Equal (internally generated). Recommendation: Contains as many items as there are different Procedure Codes in Requested Procedures if the system is able to ensure that what is acquired is what has been scheduled. Is absent if absent in MWL or performed acquisition is different from what has been scheduled.	
Referenced SOP Class UID (0008,1050)	n.a			Referenced PPS Sequence (0008,1111) (IHE-A.4.2)	1.2.840.10008.3.1.2.3.3
Referenced SOP Instance UID (0008,1155)	n.a				Equal to SOP Instance UID of associated PPS (IHE-A.4.4).
Protocol Name (0018,1030)	n.a			Recommendation: Equal (internally generated)	Performed Series Sequence (0040,0340) Equal (internally generated)

- 7100
- (IHE-A.4.1): Performed Procedure Step ID is generated by the modality arbitrarily and is not necessarily unique: Two different Performed Procedure Steps may share the same ID (e.g., may have been generated by different modalities). This ID may not enable a receiving system to reliably relate the PPS to the associated Requested Procedure and SPSs. It is not reliable to assume that two PPSs with the same PPS ID value fulfill the same set of SPSs/Requested Procedures, without checking the content of Scheduled Attributes Step Sequence.
- 7105
- (IHE-A.4.2) The Referenced Performed Procedure Step Sequence (0008,1111) that contains the PPS SOP Instance UID shall be included (per DICOM PS 3.3 Section C.7.3

strong recommendation, General Series Module Table, Note 1) when Acquisition Modality Actors support MPPS.

- 7110
- (IHE-A.4.3) In MPPS, SOP Class UID is sent in the Affected SOP Class UID (0000,0002) for the PPS N-Create message and in Requested SOP Class UID (0000,0003) for the PPS N-Set message. SOP Class UID (0008,0016) shall not be used.
 - (IHE-A.4.4) In MPPS, SOP Instance UID is sent in the Affected SOP Instance UID (0000,1000) of the PPS N-Create message and in Requested SOP Instance UID (0000,1001) for the PPS N-Set message. SOP Instance UID (0008,0018) shall not be used.
- 7115

Table A.1-5: Group Case with PGP (3 SPS belonging to 2 Requested Procedures) - required mapping of corresponding attributes

7120 As an extension to Table A.1-4, this scenario is based on the same grouping: the first Requested Procedure has 1 SPS, and the 2nd Requested Procedure contains 2 SPSs (grouping as in the diagram in Section 4.6.4.1.2.3.6).

7125 This table assumes that a Group Case acquisition has already been performed as part of the IHE Scheduled Workflow Profile Option. It describes the mapping on any actor (e.g., Acquisition Modality) that creates the GSPS and the PPS generated during the presentation step (i.e., split step) of the workflow. Therefore, the input of the mapping comes from Image IODs resulting from that previous Group Case acquisition (see Table A.1-4).

7130 Note: For generating the append PPS to a group case, the Modality actor needs to fill in additional attributes currently not defined in DICOM, which relate to requested or scheduled information. A Correction Proposal to DICOM requests to resolve these issues by adding optional attributes to the Request Attributes Sequence in Image IODs and to the Scheduled Step Attribute Sequence in MPPS (for details see RAD TF-1: B.2.2).

7135

7140

DICOM attribute	Image IOD from Group Case Acquisition			Filling values for:										
				Presentation Group 1			Presentation Group 2							
				GSPS IOD		MPPS IOD	GSPS IOD		MPPS IOD					
Study Instance UID (0020,000D)	Equal			Equal	Item 1 Equal	Equal	Item 1 Equal	Item 2 Equal						
Accession number (0008,0050)	Equal. See (IHE-A.5.1)			Equal. See (IHE-A.5.1)	Equal. See (IHE-A.5.2)	Equal. See (IHE-A.5.1)	Equal. See (IHE-A.5.2)	Equal. See (IHE-A.5.2)						
Referenced Study Sequence (0008,1110)	Item 1 Equal-1	Item 2 Equal-2		Equal-1	Scheduled Step Attributes Sequence (0040,0270)	Equal-1	Equal-2		Scheduled Step Attributes Sequence (0040,0270)	Equal-2	Equal-2			
Requested Procedure ID (0040,1001)	Request Attributes Sequence (0040,0275)	Item 1 Equal-1	Item 2 Equal-2	Item 3 Equal-2		Item 1 Equal-1	Request Attributes Sequence (0040,0275)	Item 1 Equal-2		Item 2 Equal-2	Request Attributes Sequence (0040,0275)	Equal-2	Equal-2	
Requested Procedure Description (0032,1060)		Equal-1	Equal-2	Equal-2		Equal-1		Equal-1		Equal-2		Equal-2	Equal-2	Equal-2
Requested Procedure Code Sequence (0032,1064)		Equal-1	Equal-2	Equal-2		Equal-1		Equal-1		Equal-2		Equal-2	Equal-2	Equal-2
Scheduled Procedure Step ID (0040,0009)		Equal-1	Equal-2	Equal-3		Equal-1		Equal-1		Equal-2		Equal-3	Equal-2	Equal-3
Scheduled Procedure Step Description (0040,0007)		Equal-1	Equal-2	Equal-3		Equal-1		Equal-1		Equal-2		Equal-3	Equal-2	Equal-3
Scheduled Protocol Code Sequence (0040,0008)		Equal-1	Equal-2	Equal-3		Equal-1		Equal-1		Equal-2		Equal-3	Equal-2	Equal-3
Accession number (0008,0050)		Equal-1	Equal-2	Equal-2		Equal-1		n.a.		Equal-2		Equal-2	n.a.	n.a.
Study Instance UID (0020,000D)		Equal-1	Equal-2	Equal-2		Equal-1		n.a.		Equal-2		Equal-2	n.a.	n.a.
Referenced Study Sequence (0008,1110)		Equal-1	Equal-2	Equal-2		Equal-1		n.a.		Equal-2		Equal-2	n.a.	n.a.
Performed Protocol Code Sequence (0040,0260)		Note: Values shall not be used for the GSPS and associated MPPS.			Equal-1 (internally generated). See (IHE-A.5.3)	Equal-1 (internally generated). See (IHE-A.5.4)		Equal-2 (internally generated). See (IHE-A.5.3)		Equal-2 (internally generated). See (IHE-A.5.4)				
Study ID (0020,0010)	Equal			Equal	Equal	Equal		Equal						
Performed Procedure Step ID (0040,0253)	Note: Value shall not be used for the GSPS and associated MPPS.			Equal-1 (internally generated). See (IHE-A.5.5)	Equal-1 (internally generated). See (IHE-A.5.5)	Equal-2 (internally generated). See (IHE-A.5.5)		Equal-2 (internally generated). See (IHE-A.5.5)						

DICOM attribute	Image IOD from Group Case Acquisition	Filling values for:			
		Presentation Group 1		Presentation Group 2	
		GSPS IOD	MPPS IOD	GSPS IOD	MPPS IOD
Performed Procedure Step Start Date (0040,0244)	Note: Value shall not be used for the GSPS and associated MPPS.	Equal-1 (internally generated). See (IHE-A.5.6)	Equal-1 (internally generated)	Equal-2 (internally generated). See (IHE-A.5.6)	Equal-2 (internally generated)
Performed Procedure Step Start Time (0040,0245)	Note: Value shall not be used for the GSPS and associated MPPS.	Equal-1 (internally generated). See (IHE-A.5.6)	Equal-1 (internally generated)	Equal-2 (internally generated). See (IHE-A.5.6)	Equal-2 (internally generated)
Performed Procedure Step Description (0040,0254)	Note: Value shall not be used for the GSPS and associated MPPS.	Equal-1 (internally generated). See (IHE-A.5.6)	Equal-1 (internally generated)	Equal-2 (internally generated). See (IHE-A.5.6)	Equal-2 (internally generated)
Procedure Code Sequence (0008,1032)	Equal. Note: This information is not always sufficient for linking each SPS to the proper Requested Procedure.	Equal. If present in images, then it shall contain a single item (code of the associated Requested Procedure).	Equal. If present in images, then it shall contain a single item (code of the associated Requested Procedure).	Equal. If present in images, then it shall contain a single item (code of the associated Requested Procedure).	Equal. If present in images, then it shall contain a single item (code of the associated Requested Procedure).
Referenced SOP Class UID (0008,1050)	Note: Value shall not be used for the GSPS and associated MPPS.	Referenced PPS Sequence (0008,1111) (IHE-A.5.8) 1.2.840.10008.3.1.2.3.3	Equal (internally generated). See (IHE-A.5.7)	Referenced PPS Sequence (0008,1111) (IHE-A.5.8) 1.2.840.10008.3.1.2.3.3	Equal (internally generated). See (IHE-A.5.7)
Referenced SOP Instance UID (0008,1155)			Equal (internally generated). See (IHE-A.5.8)		Equal (internally generated). See (IHE-A.5.8)
Protocol Name (0018,1030)	Note: Value shall not be used for the GSPS and associated MPPS.	Recommendation: Equal-1 (internally generated)	Performed Series Sequence (0040,0340) Equal-1 (internally generated)	Recommendation: Equal-2 (internally generated)	Performed Series Sequence (0040,0340) Equal-2 (internally generated)

- 7145
- (IHE-A.5.1) When several SPSs belonging to Requested Procedures attached to the same Imaging Service Request have been grouped together, the original value of Accession Number (0008,0050) shall be copied in the Accession Number field in GSPSs. When the grouped SPSs belong to Requested Procedures attached to different Imaging Service Request, the Accession Number (0008, 0050) in the original images is expected to be empty per the group case specified by IHE. Therefore, it shall also be empty in generated GSPS (as they belong to the same Study as the original images).
- 7150
- (IHE-A.5.2) The Accession Number in MPPS objects shall be equal to the MWL Accession Number return value, irrespective of the Accession Number value (including zero length) in Image and Standalone IODs and GSPSs.

- 7155 • (IHE-A.5.3) Recommendation: Absent if the value is not known. If Assisted Protocol Setting option is supported (see Section 4.6.4.1.2.4), the value is recommended to be non-empty and contain a specific code that indicates the splitting of grouped images.
- 7160 • (IHE-A.5.4) Shall be zero length if the value is not known, e.g., Assisted Protocol Setting is not supported. If Assisted Protocol Setting Option is supported (see Section 4.6.4.1.2.4), the value is recommended to be non-empty and contain a specific code that indicates the splitting of grouped images.
- 7165 • (IHE-A.5.5) Performed Procedure Step ID is generated by the modality arbitrarily and is not necessarily unique: Two different Performed Procedure Steps may share the same ID (e.g., may have been generated by different modalities). This ID may not enable a receiving system to reliably relate the PPS to the associated Requested Procedure and SPSs. It is not reliable to assume that two PPSs with the same PPS ID value fulfill the same set of SPSs/Requested Procedures, without checking the content of Scheduled Attributes Step Sequence.
- 7170 • (IHE-A.5.6) In the GSPS IODs created during the “splitting” step of PGP, the Study Date, Study Time and Study Description shall re-use the corresponding values from the source image to which they are appended.
- 7175 • (IHE-A.5.7) In MPPS, SOP Class UID is sent in the Affected SOP Class UID (0000,0002) for the PPS N-Create message and in Requested SOP Class UID (0000,0003) for the PPS N-Set message. SOP Class UID (0008,0016) shall not be used.
- 7180 • (IHE-A.5.8) In MPPS, SOP Instance UID is sent in the Affected SOP Instance UID (0000,1000) of the PPS N-Create message and in Requested SOP Instance UID (0000,1001) for the PPS N-Set message. SOP Instance UID (0008,0018) shall not be used.
- 7180 • (IHE-A.5.9) The Referenced Performed Procedure Step Sequence (0008,1111) that contains the PPS SOP Instance UID shall be included (per DICOM PS 3.3 Section C.7.3 strong recommendation, General Series Module Table, Note 1) when Acquisition Modality Actors support MPPS.

A.2: Evidence Documents Integration - Critical Attributes

- 7185 The table in this section is analogous to the tables in the previous section, where the Acquisition Modality uses certain attributes from the Modality Worklist in order to fill in related image values in a consistent manner. Similarly, the Evidence Creator or Acquisition Modality in the Evidence Documents Integration Profile, which do not get a Modality Worklist, use relevant data from images that originate from a scheduled acquisition as input for consistently filling in corresponding values in DICOM SR Evidence Documents.
- 7190 Note: In the Scheduled Workflow Integration Profile, the Evidence Creator creates images. This case can be considered an image acquisition append case (see Table A.1-2).

General table structure:

- 7195 • The 1st column denotes the DICOM attributes whose values shall be mapped between the DICOM objects (equal values in the same table row). The DICOM attribute tag is indicated for clarity.
- 7200 • The 2nd and 3rd columns define for each attribute how the attribute values are filled for the different IODs.
These columns read left to right within the same row: Image/ Standalone IOD (2nd column) shall be used as the source for copies to Evidence Documents (DICOM SR IOD).

Cell content conventions:

- These are the same as defined in the corresponding paragraph of Section A.1.

Actor behavior:

- 7205 • The values from the Image/ Standalone IOD, if available as a source, shall be used by the Evidence Creator or Acquisition Modality to fill in the attribute shown on the corresponding rows for Evidence Document instances.

Table A.2-1: Evidence Document Attribute Mapping

7210 This table defines how to use values from Image or Standalone IODs that were previously generated by a *different* actor in order to fill in values into newly generated Evidence Documents created by an Evidence Creator or Acquisition Modality in the Evidence Documents Integration Profile.

7215 Note that this mapping table is most relevant for cases where evidence is created based on images that originate from a scheduled acquisition, otherwise most of the workflow integration-critical attributes will be absent or empty in the originating Image/ Standalone IODs. This table does not take into account cases where Evidence Documents are generated as a result of Post-Processing Workflow.

DICOM attribute	Image/ Standalone IOD		Filling values for Evidence Documents	
Study Instance UID (0020,000D)	Source		Copy (IHE-A.2-1.1)	
Referenced Study Sequence (0008,1110)	Source. (IHE-A.2-1.2)		Copy, if not absent in Image/ Standalone IOD. (IHE-A.2-1.1)	
Accession number (0008,0050)	Source		Copy (IHE-A.2-1.1)	
Requested Procedure ID (0040,1001)	Request Attributes Sequence (0040,0275)	Source (IHE-A.2-1.2)	Referenced Request Sequence (0040,A370)	Copy, if not absent in Image/ Standalone IOD.
Requested Procedure Description (0032,1060)		Source (IHE-A.2-1.2)		Copy, if not absent in Image/ Standalone IOD.
Requested Procedure Code Sequence (0032,1064)		Source (IHE-A.2-1.2)		Copy, if not absent in Image/ Standalone IOD.

DICOM attribute	Image/ Standalone IOD	Filling values for Evidence Documents
Procedure Code Sequence (0008,1032)	Source. Note: May be absent.	Recommendation: Copy, if not absent in Image/ Standalone IOD.

- 7220 • (IHE-A.2-1.1) If the creation of evidence relates to a Requested Procedure, it is required per DICOM to also fill this information in the Referenced Request Sequence (0040,A370).
- (IHE-A.2-1.2) May be absent in case of an unscheduled image acquisition.

A.3: Context-critical Attributes

7225 This section extends the above table with additional IHE Requirements based on a number of context-critical attributes (Type 2 in DICOM) common to most images and standalone IODs when provided in response to a C-FIND Request in Return Key Attributes. The content of this table is strictly consistent with PS 3.17 Annex J of DICOM.

Modality Worklist	Images and Standalone IOD	MPPS IOD
Patient Name	Patient Name (Note 1)	Patient Name (Note 1)
Patient ID	Patient ID (Note 1)	Patient ID (Note 1)
Patient's Birth Date	Patient's Birth Date (Note 2)	Patient's Birth Date (Note 2)
Patient's Sex	Patient's Sex (Note 2)	Patient's Sex (Note 2)
Referring Physician's Name	Referring Physician's Name (Note 2)	----

7230 Note 1: This Attribute may be zero length when the Department System Scheduler/Order Filler providing the Modality Worklist service is not accessible. Pre-registered values for Patient ID and Patient Name will be used in the Unidentified Patient cases defined in the IHE Radiology Technical Framework.

Note 2: Attribute may be zero length when the Department System Scheduler/Order Filler providing Modality Worklist service is not accessible or the Attributes returned by MWL are zero length.

A.4: Consistency Data Model

7235 The section introduces a data model of the entities and their Attributes related to Consistency. Readers are advised to use this data model along with the table presented in Section 1 of this appendix. This data model is provided only for ease of understanding and does not introduce any additional IHE requirements than those specified in Section C.2.

Entities are shown by solid line rectangular boxes.

7240 A relationship between two entities is shown by an arrow or a straight line. In the case of straight lines the Attributes used to define this relationship are not described by this model (they are generally well understood). In the case an arrow is used:

- 7245 • The attribute in the referencing entity used to define this relationship is shown within the entity in a box next to the origin of the arrow (e.g., Ref. St. Seq. in the Requested Procedure Entity is used to link this entity with the Conceptual Study Management entity).

- 7250
- The referenced attribute is shown at the tip of the arrow also in a rectangular box but with curly brackets (e.g., `{Study Instance UID}`). In some cases the referencing Attribute has a different name than this referenced Attribute. This reflects the way DICOM has elected to name and or encode those Attributes. The number shown between square brackets is the Data Type as defined by DICOM.

The cardinality of relationship is defined both along straight lines and arrows:

- 7255
- 7260
- Cardinality of the relationship between the entities is shown along the arrow/lines. The direction of the arrow has no influence on the cardinality definition. This cardinality reflects the cardinality between entities in a real-world data model (used as defined by DICOM). This cardinality may be slightly different in the DICOM Information Object Definition data models as this data-model reflects entity relationship supported in the context of information communication. For example “I-Series to I-Composite” has a 1 to 0-n relationship to reflect that a PPS may contain a series with no Composite Instances (e.g., images, GSPS). However in the context of the DICOM Storage Service Class, a Series must contain at least one Composite Instance (e.g., image, GSPS). In other terms series with no images cannot be stored but can be defined by DICOM Performed Procedure Steps.

Arrows with thick lines reflect the fact that the referencing Attributes are UID (broad uniqueness), as opposed to simple IDs, which are shown by thin line arrows.

7265 In this Data Model, two dotted-line boxes are shown:

- The first one groups 4 entities: I-Patient, I-Study, I-Series, and I-Composite. This is intended to reflect the fact that Composite Instances are transferred (Storage Service Class) by grouping these four entities. These 4 entities are those defined by DICOM Composite Image Information Model (See PS 3.3, Section A.1.2)
- The second one groups 2 entities: Requested Procedure and Conceptual Study Management. This reflects that those two entities are always in a one-to-one relationship. The Requested Procedure entity as well as those associated with it (Patient, Imaging Service Request, Schedule Procedure Step and Performed Procedure Step) are defined by the DICOM Model of the Real World for the purpose of the Modality-IS Interface (See PS 3.3, section 7.3). The “Conceptual Study Management” entity is special in that its only attribute in the context of this version of the IHE Technical Framework is the Referenced SOP Instance UID (found in Reference Study Sequence). This Conceptual Study Detached Study entity (without the Detached Management Study SOP Class being used) is defined by DICOM in PS 3.4 Section M.2.

7280

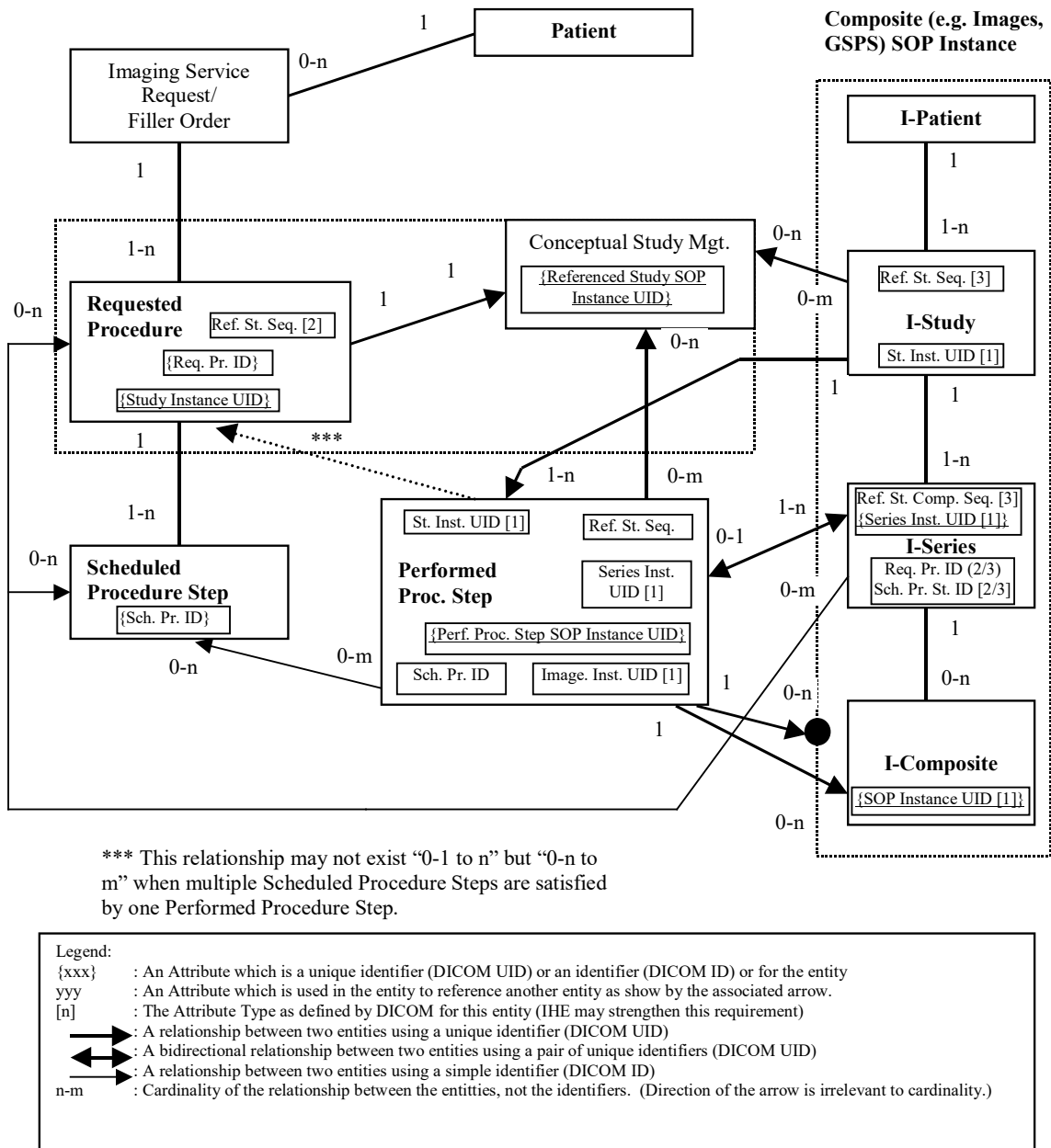

Figure A-1: Data Consistency Model: Modality Worklist Information Model, Composite IODs and Modality Performed Procedure Step IOD

A.5: Imported Object Integration – Critical Attributes

7285 The Importer shall modify each DICOM object to ensure that critical attributes from the local Enterprise are incorporated.

The tables below describe requirements, recommendations or explanations on integration-critical attributes for cases covering import of digital media and creation of digitized objects into the local environment.

7290 Until such time that Code Sets are consistent among Enterprises, the Protocol Code Sets used within one Enterprise will most likely not be valid in another Enterprise. Coercion rules or mechanisms for Code Sets are out of scope for the Radiology Technical Framework.

General table structure:

- 7295
 - The 1st column denotes the DICOM attributes whose values shall be mapped between the DICOM objects (equal values in the same table row). The DICOM attribute tag is indicated for clarity.
 - The 2nd to 5th columns define where attribute values come from: all defined attribute values of one table row are equal. These columns read left to right.
- 7300
 - The column labeled ‘Objects for Import’ refers to attributes and values included in, or “extracted” from the objects to be imported. In the case of hardcopy import (i.e., digitization), this extraction can be done via OCR or manual entry, extracted from the paperwork accompanying the media, or via some other mechanism. It is likely that values will not be available for some of the attributes in that column.
- 7305
 - The column labeled ‘Resultant IOD’ signifies the attributes and values included in the objects resulting from the Import action (regardless of the source of the import).
 - The MWL column is replaced by a column entitled ‘Demographic Query Information’ for unscheduled cases where the Importer receives information via an HL7 query message rather than via a DICOM MWL response.

Cell content conventions:

- 7310
 - “Source” in a table cell means that the DICOM object defined in the table column (e.g., MWL) and created by one actor shall be the source of this value for the DICOM attribute for another actor to fill in this value for their own objects (e.g., Image or MPPS).
 - “Copy” in a table cell means that the value shall be copied from a corresponding source attribute of another DICOM object, as defined by the table column.
- 7315
 - ”Copy from: <DICOM attribute>” means that, instead of using the DICOM attribute of the same row as the source, the source as specified in the referenced DICOM attribute shall be used.
 - “Equal” in a table cell means that an actor already knows the value, e.g., from some previously performed action. Thus, the circumstances of value generation do not matter.
- 7320
 - “Equal (internally generated)” in a table cell means that an actor has internally generated a value that may be used in more than one DICOM object, without having obtained this value from another actor (i.e., no copy).

- "Source-1", "Copy-1" or "Equal-1" etc. are corresponding mapping attribute values, if several sources appear in one table row.
- 7325 • "Copy-2 [Copy-1]" in a table cell means Copy the value from Source-2 (Copy-2) if present, otherwise Copy from Source-1 (Copy-1).
- "Merge Copy-1, Copy-2" in a table cell means that the values copied from multiple sources are all to be included in the resulting attribute. Note: this is done only for some multi-valued or sequence attributes.
- 7330 • "See (IHE-X)" in a table cell denotes additional requirements, recommendations or explanations for the attribute value, as described in the table's note "(IHE-X)". Otherwise, brief text that fits into a table cell is presented in the cell.
- "n.a." in a table cell means that such an attribute or value shall not exist. Either the attribute is not defined by the DICOM standard for this object, or the particular sequence attribute is a DICOM type 3 attribute, and DICOM requires at least one sequence item to be present.
- 7335

Actor behavior:

- The general goal for the 'importing' actor (Importer) is to minimally change the original Objects. Only attributes that are critical to ensure identification consistency in the receiving environment are coerced.
- 7340
- The 'importing' actor (Importer) shall use the values in the second and third columns ('Objects for Import' and 'MWL return values' or 'Demographic Query Information') as the source for copying into the Image/ Standalone or MPPS IODs according to the rules defined within the tables.
- 7345
- The 'importing' actor (Importer) shall not assume that instances on the media are from the same Series, Study, Patient, etc. There are cases where the media may contain multiple patients.
- Any attribute value in the original Objects for Import that is replaced by the importing actor shall be recorded in the 'Original Attributes Sequence' contained in the Objects resulting from the import activity.
- 7350
- Attributes from the column "Modality Worklist" shall be requested by a MWL SCU (Importer) as a return key in its C-FIND Requests. The Department System Scheduler shall return attribute values in the Modality Worklist C-FIND response (for a complete description, see Table 4.5-3).
- 7355
- The PPS Manager, Image Manager and Department System Scheduler Actors shall be capable of handling the attributes shown in the column titled "MPPS IOD" as defined by the SCP Type and the additional notes. The general goal is to use the PPS information presenting for the imported instances for use in the resulting PPS.

7360

Table A.5-1: Scheduled Import - Required Mapping of Corresponding Attributes

DICOM attribute	Objects for Import	Modality Worklist (return attribute values)	Filling values for:			
			Resultant IOD	MPPS IOD		
Patient Name (0010,0010)	Source-1	Source-2	Copy-2 [Copy-1]			
Patient ID (0010,0020)	Source-1	Source-2	Copy-2 [Copy-1]			
Other Patient Ids (0010,1000)	Source-1	Source-2	Merge Copy-1,Copy-2	n.a		
Patient's Birth Date (0010,0030)	Source-1	Source-2	Copy-2 [Copy-1]			
Patient's Sex (0010,0040)	Source-1	Source-2	Copy-2 [Copy-1]			
Study Instance UID (0020,000D)	Source-1 (See IHE-A.5.1.2)	Source-2	Copy-1 [Copy-2] (See IHE-A.5.1.2)	Scheduled Step Attributes Sequence (0040,0270)		
Referenced Study Sequence (0008,1110)	Source-1 See (IHE-A.5.1.8)	Source-2 See (IHE-A.5.1.6)	Copy-1 [Copy-2]		Copy-1 [Copy-2] (See IHE-A.5.1.2)	
Accession number (0008,0050)	Source-1	Source-2	Copy-2 See (IHE- A.5.1.3)		Copy-1 [Copy-2]	
Requested Procedure ID (0040,1001)	Source-1	Source-2	Request Attributes Sequence (0040,0275)		Copy-2 [Copy-1]	
Requested Procedure Description (0032,1060)	Source-1	Source-2			Copy-2 [Copy-1] See (IHE-A.5.1.7)	Copy-2 [Copy-1] See (IHE-A.5.1.3)
Scheduled Procedure Step ID (0040,0009)	Source-1	Source-2			Copy-2 [Copy-1]	Copy-2 [Copy-1]
Scheduled Procedure Step Description (0040,0007)	Source-1	Source-2			Copy-1	Copy-2 [Copy-1] See (IHE-A.5.1.7)
Scheduled Protocol Code Sequence (0040,0008)	Source-1	Source-2			Copy-1 See (IHE-A.5.1.7)	Copy-2 [Copy-1]
Performed Protocol Code Sequence (0040,0260)	Source-1	n.a.	Copy-1 See (IHE-A.5.1.9)		Copy-2	
Study ID (0020,0010)	Source	n.a.	Copy [Equal (Internally Generated Recommendation: Use Requested Procedure ID from MWL)]		Copy [Equal (Internally Generated Recommendation: Use Requested Procedure ID from MWL)]	

DICOM attribute	Objects for Import	Modality Worklist (return attribute values)	Filling values for:	
			Resultant IOD	MPPS IOD
Performed Procedure Step ID (0040,0253)	Source See (IHE-A.5.1.1)	n.a.	Copy See (IHE-A.5.1.1)	Copy [Equal (Internally Generated)] See (IHE-A.5.1.1)
Performed Procedure Step Description (0040,0254)	Source	n.a.	Copy See (IHE-A.5.1.7)	Copy See (IHE-A.5.1.7)
Performed Procedure Step Start Date (0040,0244)	Source	n.a.	Copy	Equal (internally generated).
Performed Procedure Step Start Time (0040,0245)	Source	n.a.	Copy	Equal (internally generated).
Requested Procedure Code Sequence (0032,1064)	n.a.	Value shall be used for Procedure Code Sequence as specified below.	n.a.	n.a.
Procedure Code Sequence (0008,1032)	n.a.	n.a.	Copy from: Requested Procedure Code Sequence (0032,1064). See (IHE-A.5.1.7)	Copy from: Requested Procedure Code Sequence (0032,1064) See (IHE-A.5.1.7)
Referenced SOP Class UID (0008,1150)	n.a.	n.a.	Referenced PPS Sequence (IHE-A.1.3)	1.2.840.1008.3.1.2.3.3 See (IHE-A.5.1.4)
Referenced SOP Instance UID (0008,1155)	n.a.	n.a.		Equal to SOP Instance UID of the associated MPPS See (IHE-A.5.1.5)

7365

- (IHE-A.5-1.1) Performed Procedure Step ID may be generated by the Importer arbitrarily and is not necessarily unique: Two different Performed Procedure Steps may share the same ID (e.g., may have been generated by different importers). The Performed Procedure Step ID (0040,0253) will not be available when data is imported from non-digital media (e.g., digitized hardcopy objects)
- (IHE-A.5-1.2) Valid DICOM UIDs are universally unique, so there should be no risk of collision with local UIDs. When a valid set of DICOM UIDs is present the importer shall use this set and not change them. If the importer detects incorrect UIDs or an inconsistent

- 7370 set of UIDs, then it may correct or re-generate UIDs. The UIDs are used as references between objects, and if they are altered, the Importer shall maintain referential integrity.
- (IHE-A.5-1.3) A Zero Length Accession Number shall be created when no reliable value for this attribute is available. Reliable values are those that can be conveyed by means other than manual data entry such as a value received from the Order Filler via a Modality Worklist including an Accession Number or received through a bar code reader.
- 7375
- (IHE-A.5-1.4) In MPPS, SOP Class UID is sent in the Affected SOP Class UID (0000,0002) for the PPS N-Create message and in Requested SOP Class UID (0000,0003) for the PPS N-Set message. SOP Class UID (0008,0016) shall not be used.
 - (IHE-A.5-1.5) In MPPS, SOP Instance UID is sent in the Affected SOP Instance UID (0000,1000) of the PPS N-Create message and in Requested SOP Instance UID (0000,1001) for the PPS N-Set message. SOP Instance UID (0008,0018) shall not be used.
- 7380
- (IHE-A.5-1.6) According to the Query Modality Worklist transaction (Section 4.5.4.1.2.2), the DSS/ Order Filler is required to replicate the Study Instance UID value in both the Study Instance UID attribute (0020,000D) and within the Referenced Study Sequence (0008,1110).
- 7385
- (IHE-A.5-1.7) Descriptions and Codes used in the Enterprise may not match those used in the Evidence Objects. The method used to coerce the Descriptions or Codes is out of scope of the Technical Framework. Note that the Descriptions and Codes from the Evidence Objects may be useful.
- 7390
- (IHE-A.5-1.8) The Referenced Study Sequence (0008,1110) will not be available when data is imported from non-digital media (e.g., digitized hardcopy objects)
 - (IHE-A.5-1.9) Performed Protocol Codes used in the Enterprise may not match those used in the Evidence Objects. Determination of whether to copy, coerce or remove the Codes is out of scope of the Technical Framework. Note that the Codes from the Evidence Objects may be useful.
- 7395
- (IHE-A.5-1.10) See Section RAD TF-3: 4.59.4.1.2.3. If no information about the Scheduled Import exists, this shall be internally generated and included as one of the items in the Performed Protocol Sequence. The Performed Protocol Codes present in the Objects for Import may not match those used in the Evidence Objects. Determination of whether to merge, coerce and merge or discard the Codes is out of scope of the Radiology Technical Framework. Note that the Codes from the Evidence Objects may be useful.
- 7400

Table A.5-2: Unscheduled Import - required mapping of corresponding attributes

DICOM attribute	Objects for Import	Demographic Query Information (return attribute values)	Filling values for:	
			Resultant IOD	MPPS IOD
Patient Name (0010,0010)	Source-1	Source-2 PID:5	Copy-2 [Copy-1]	
Patient ID (0010,0020)	Source-1	Source-2 PID:3	Copy-2 [Copy-1]	
Other Patient Ids (0010,1000)	Source-1	Source-2 PID:4	Merge Copy-1,Copy-2	n.a
Patient's Birth Date (0010,0030)	Source-1	Source-2 PID:7	Copy-2 [Copy-1]	
Patient's Sex (0010,0040)	Source-1	Source-2 PID:8	Copy-2 [Copy-1]	
Study Instance UID (0020,000D)	Source (See IHE-A.5.2.6)	n.a	Copy or Equal (internally generated) (See IHE-A.5.2.6)	Scheduled Step Attributes Sequence (0040,0270)
Accession number (0008,0050)	Source	n.a	Shall be empty (zero length).	
Requested Procedure ID (0040,1001)	Source	n.a	Request Attributes Sequence (0040,0275) Equal (internally generated)	
Scheduled Procedure Step ID (0040,0009)	Source	n.a	Copy	
Scheduled Protocol Code Sequence (0040,0008)	Source	n.a	Copy	Copy [Equal (internally generated)]
Performed Protocol Code Sequence (0040,0260)	Source	n.a	Copy See (IHE-A.5.2.7)	Merge Copy (internally generated). Shall contain a code indicating that an import was performed See (IHE A.5.2.8)
Study ID (0020,0010)	Source	n.a.	Copy [Equal (Internally Generated)]	Copy [Equal (Internally Generated)]
Performed Procedure Step ID (0040,0253)	Source	n.a.	Copy See (IHE-A.5.2.1)	Copy [Equal (Internally Generated)] See (IHE-A.5.2.1)
Performed Procedure Step Description (0040,0254)	Source	n.a.	Copy See (IHE-A.5.2.5)	Copy See (IHE-A.5.2.5)

DICOM attribute	Objects for Import	Demographic Query Information (return attribute values)	Filling values for:	
			Resultant IOD	MPPS IOD
Performed Procedure Step Start Date (0040,0244)	Source	n.a	Copy	Equal (internally generated).
Performed Procedure Step Start Time (0040,0245)	Source	n.a	Copy	Equal (internally generated).
Requested Procedure Code Sequence (0032,1064)	n.a	Value shall be used for Procedure Code Sequence as specified below.	n.a	n.a.
Procedure Code Sequence (0008,1032)	n.a	n.a.	Copy from: Requested Procedure Code Sequence (0032,1064). See (IHE-A.5.2.5)	Copy from: Requested Procedure Code Sequence (0032,1064) See (IHE-A.5.2.5)
Referenced SOP Class UID (0008,1150)	n.a.	n.a.	Referenced PPS Sequence (IHE-A.2.2.2)	1.2.840.1008.3.1.2.3.3 See (IHE-A.5.2.3)
Referenced SOP Instance UID (0008,1155)	n.a.	n.a.		Equal to SOP Instance UID of the associated MPPS See (IHE-A.5.2.4)

7405

- (IHE-A.5-2.1) Performed Procedure Step ID is generated by the importer arbitrarily and is not necessarily unique: Two different Performed Procedure Steps may share the same ID (e.g., may have been generated by different importers).

7410

- (IHE-A.5-2.2) The Referenced Performed Procedure Step Sequence (0008,1111) that contains the PPS SOP Instance UID shall be included (per DICOM PS 3.3 section C.7.3 strong recommendation, General Series Module Table, Note 1).

- (IHE-A.5-2.3) In MPPS, SOP Class UID is sent in the Affected SOP Class UID (0000,0002) for the PPS N-Create message and in Requested SOP Class UID (0000,0003) for the PPS N-Set message. SOP Class UID (0008,0016) shall not be used.

7415

- (IHE-A.5-2.4) In MPPS, SOP Instance UID is sent in the Affected SOP Instance UID (0000,1000) of the PPS N-Create message and in Requested SOP Instance UID (0000,1001) for the PPS N-Set message. SOP Instance UID (0008,0018) shall not be used.

- 7420 • (IHE-A.5-2.5) Descriptions and Codes used in the Enterprise may not match those used in the Evidence Objects for Import. The method used to coerce the Descriptions or Codes is out of scope of the Radiology Technical Framework. Note that the Descriptions and Codes from the Evidence Objects may be useful.
- 7425 • (IHE-A.5-2.6) Ideally, UIDs are universally unique, so there should be no risk of collision with local UIDs, and hence there should be no reason to change them. However, since the integrity of externally generated data cannot be ensured, it may be necessary to correct or re-generate UIDs. The UIDs are used as references between objects, and if they are altered, the Importer shall maintain referential integrity.
- 7430 • (IHE-A.5-2.7) Performed Protocol Codes used in the Enterprise may not match those used in the Evidence Objects. Determination of whether to copy, coerce or remove the Codes is out of scope of the Radiology Technical Framework. Note that the Codes from the Evidence Objects may be useful.
- 7435 • (IHE-A.5-2.8) See Section RAD TF-3: 4.59.4.1.2.3. The Performed Protocol Codes present in the Objects for Import may not match those used in the Evidence Objects. Determination of whether to merge, coerce and merge or discard the Codes is out of scope of the Technical Framework. Note that the Codes from the Evidence Objects may be useful.

Appendix B: HL7 Order Mapping to DICOM MWL

7440 This appendix defines the mapping of the HL7 ADT, OMG and ORM messages to the DICOM Modality Worklist. Note that the HL7 messages address information regarding the order, not scheduling or resource management information. The scheduling and resource management is internal to the Department System Scheduler.

7445 Note that this mapping does not apply to Procedure Scheduled Transaction (message from Department System Scheduler to Image Manager, see Section 4.4). Also see the IHE ER Model (RAD TF-1: 3.4) and the HL7 Implementation Notes in Section 2.5 for a more thorough definition of field lengths, value representations, and attribute types. Mappings between HL7 and DICOM are illustrated in the following manner:

- Element Name (HL7 item_number.component #/ DICOM (group, element))
- 7450 • The component value is not listed if the HL7 element does not contain multiple components

Table B-1: HL7 Order Mapping to DICOM MWL

DICOM Description / Module	DICOM Tag	DICOM SCP Matching Key Type	DICOM SCP Return Key Type	HL7 Description	HL7 Item #	HL7 v2.3.1 Segment	HL7 v2.5.1 Segment	Notes
SOP Common								
Specific Character Set	(0008,0005)	O	1C	Character Set	00692	ORM MSH:18	OMG MSH:18	
Scheduled Procedure Step								
Scheduled Procedure Step Sequence	(0040,0100)	R	1					
>Scheduled station AE title	(0040,0001)	R	1					Generated by the department system scheduler
>Scheduled Procedure Step Start Date	(0040,0002)	R	1					Generated by the department system scheduler
>Scheduled Procedure Step Start Time	(0040,0003)	R	1					Generated by the department system scheduler
>Modality	(0008,0060)	R	1					Generated

IHE Radiology Technical Framework, Volume 2 (RAD TF-2): Transactions

DICOM Description / Module	DICOM Tag	DICOM SCP Matching Key Type	DICOM SCP Return Key Type	HL7 Description	HL7 Item #	HL7 v2.3.1 Segment	HL7 v2.5.1 Segment	Notes
								by the department system scheduler (note 3)
>Scheduled Performing Physician's Name	(0040,0006)	R	2	Technician	00266	ORM OBR:34	OMG OBR:34	See note 9
>Scheduled Procedure Step Description	(0040,0007)	O	1C					Generated by the department system scheduler
>Scheduled Station Name	(0040,0010)	O	2					Generated by the department system scheduler
>Scheduled Procedure Step Location	(0040,0011)	O	2					Generated by the department system scheduler
>Scheduled Protocol Code Sequence	(0040,0008)	O	1C					
>>Code Value	(0008,0100)	O	1C					Generated by the department system scheduler
>>Coding Scheme Designator	(0008,0102)	O	1C					Generated by the department system scheduler
>>Code Meaning	(0008,0104)	O	3					Generated by the department system scheduler
>Pre-Medication	(0040,0012)	O	2C					
>Scheduled Procedure Step ID	(0040,0009)	O	1	N/A				Generated by the department system

DICOM Description / Module	DICOM Tag	DICOM SCP Matching Key Type	DICOM SCP Return Key Type	HL7 Description	HL7 Item #	HL7 v2.3.1 Segment	HL7 v2.5.1 Segment	Notes
								scheduler
>Requested Contrast Agent	(0032,1070)	O	2C	N/A				Generated by the department system scheduler
>Scheduled Procedure Step Status	(0040,0020)	O	3	N/A				Generated by the department system scheduler
>All other Attributes from the Scheduled Procedure Step Module		O	3					
Requested Procedure								
Requested Procedure ID	(0040,1001)	O	1					Generated by the department system scheduler
Reason for the Requested Procedure	(0040,1002)	O	3	Reason for Study	00263	ORM OBR:31	OMG OBR:31	OBR:31 may be either a code or text value; if a code, then the code meaning (display name) should be used; see also (0040,100A)
Reason for Requested Procedure Code Sequence	(0040,100A)	O	3	Reason for Study	00263	ORM OBR:31	OMG OBR:31	OBR:31 may be either a code or text value; if a text value, then the DSS may map it to a code to use in the

DICOM Description / Module	DICOM Tag	DICOM SCP Matching Key Type	DICOM SCP Return Key Type	HL7 Description	HL7 Item #	HL7 v2.3.1 Segment	HL7 v2.5.1 Segment	Notes
								DICOM attribute; see also (0040,1002)
>Code Value	(0008,0100)	O	1C					
>Coding Scheme Designator	(0008,0102)	O	1C					
>Code Meaning	(0008,0104)	O	3					
Requested Procedure Description	(0032,1060)	O	1C					Generated by the department system scheduler. See note 1
Requested Procedure Code Sequence	(0032,1064)	O	1C					
>Code Value	(0008,0100)	O	1C					Generated by the department system scheduler. See note 1
>Coding Scheme Designator	(0008,0102)	O	1C					Generated by the department system scheduler. See note 1
>Code Meaning	(0008,0104)	O	3					Generated by the department system scheduler. See note 1
Study Instance UID	(0020,000D)	O	1					Generated by the department system scheduler
Referenced Study Sequence	(0008,1110)	O	2					
>Reference	(0008,1150)	O	1C					

DICOM Description / Module	DICOM Tag	DICOM SCP Matching Key Type	DICOM SCP Return Key Type	HL7 Description	HL7 Item #	HL7 v2.3.1 Segment	HL7 v2.5.1 Segment	Notes
d SOP Class UID								
>Reference d SOP Instance UID	(0008,1155)	O	1C					
Requested Procedure Priority	(0040,1003)	O	2	Quantity/ Timing	00221.6	ORM ORC:7	OMG TQ1:9	See note 2
Patient Transport Arrangements	(0040,1004)	O	2	Transport Arrangement Response.	01031.1-3	ORM OBR:30	OMG OBR:30	
All other Attributes from the Requested Procedure Module		O	3					
Imaging Service Request								
Accession Number	(0008,0050)	O	2					Generated by the department system scheduler
Requesting Physician	(0032,1032)	O	2	Ordering Provider	00226.1-7	ORM OBR:16	OMG OBR:16	
Referring Physician's Name	(0008,0090)	O	2	Referring Doctor	00138.1-7	ORM PV1:8	OMG PV1:8	
Placer Issuer and Number	(0040,2016)	O	2	Placer Order #	00216.1-2	ORM ORC:2	OMG ORC:2	See note 4
Filler Issuer and Number	(0040,2017)	O	2	Filler Order #	00217.1-2	ORM ORC:3	OMG ORC:3	See note 4
Reason for Imaging Service Request	(0040,2001)	O	2	Reason for Study	00263	ORM OBR:31	OMG OBR:31	The attribute (0040,2001) was retired by DICOM in 2004 in favor of (0040,1002) and (0040,100A). Accordingly, the

DICOM Description / Module	DICOM Tag	DICOM SCP Matching Key Type	DICOM SCP Return Key Type	HL7 Description	HL7 Item #	HL7 v2.3.1 Segment	HL7 v2.5.1 Segment	Notes
								DICOM return key may be empty, or a duplicate of (0040,1002) and/or the code meaning of (0040,100A).
Entered by....	(0040,2008)	O	3	Entered by....	00224.2-6	ORM ORC:10	OMG ORC:10	
Order Entering Location	(0040,2009)	O	3	Entering Organization	00231.2	ORM ORC:17	OMG ORC:17	
Order Callback Phone Number	(0040,2010)	O	3	Order Callback Phone Number	00228	ORM ORC:14	OMG ORC:14	
All other Attributes from the Scheduled Procedure Step Module		O	3					
Visit Identification								
Admission ID	(0038,0010)	O	2	Patient Account Number or Visit Number	00121.1 or 00149.1	ORM PID: 18 or PV1:19	OMG PID: 18 or PV1:19	See note 6
Issuer of Admission ID	(0038,0011)	O	2	Patient Account Number or Visit Number	00121.4 or 00149.4	ORM PID:18 or PV1-19	OMG PID:18 or PV1-19	See note 6
All other Attributes from the Visit Identification Module		O	3					
Visit Status								
Current Patient Location	(0038,0300)	O	2	Assigned Pat. Loc.	00133	ORM PV1:3	OMG PV1:3	
All other Attributes		O	3					

DICOM Description / Module	DICOM Tag	DICOM SCP Matching Key Type	DICOM SCP Return Key Type	HL7 Description	HL7 Item #	HL7 v2.3.1 Segment	HL7 v2.5.1 Segment	Notes
from the Visit Status Module								
Visit Relationship								
Referenced Patient Sequence	(0008,1120)	O	2					
>Referenced SOP Class UID	(0008,1150)	O	2					
>Referenced SOP Instance UID	(0008,1155)	O	2					
All other Attributes from the Visit Relationship Module		O	3					
Visit Admission								
All Attributes from the Visit Admission Module		O	3					
Patient Relationship								
All Attributes from the Patient Relationship Module		O	3					
Patient Identification								
Patient's Name	(0010,0010)	R	1	Patient Name	00108	ORM PID:5	OMG PID:5	See note 10
Patient ID	(0010,0020)	R	1	External Patient ID	00105.1	ORM PID:3.1	OMG PID:3.1	See note 5
Issuer of Patient ID	(0010,0021)	O	3	External Patient ID	00105.4	ORM PID:3.4	OMG PID:3.4	See note 5
Ethnic Group	(0010,2160)	O	3	Ethnic Group	00125	ORM PID:22	OMG PID:22	
All other Attributes from the		O	3					

DICOM Description / Module	DICOM Tag	DICOM SCP Matching Key Type	DICOM SCP Return Key Type	HL7 Description	HL7 Item #	HL7 v2.3.1 Segment	HL7 v2.5.1 Segment	Notes
Patient Identification Module								
Patient Demographic								
Patients Birth Date	(0010,0030)	O	2	Date/ Time of Birth	00110.1	ORM PID:7	OMG PID:7	
Patient's Sex	(0010,0040)	O	2	Sex	00111	ORM PID:8	OMG PID:8	See Note 11
Patient's Weight	(0010,1030)	O	2	Observation Value	00573 when 00571.2 = "Body Weight" and 00574.1 = "kg"	ADT OBX:5	ADT OBX:5	See note 7
Patient's Size	(0010,1020)	O	2	Observation Value	00573 when 00571.2 = "Body Height" and 00574.1 = "m"	ADT OBX:5	ADT OBX:5	See note 7
Confidentiality constraint on patient data	(0040,3001)	O	2	VIP Indicator	146	ORM PV1:16	OMG PV1:16	
Region of Residence	(0010,2152)	O	3	Citizenship	00129	ORM PID:26	OMG PID:26	
Military Rank	(0010,1080)	O	3	Veterans Military Status	00130	ORM PID:27	OMG PID:27	
All other Attributes from the Patient Demographic Module		O	3					
Patient Medical								
Patient State	(0038,0500)	O	2	Danger Code	00246	ORM OBR:12	OMG OBR:12	

DICOM Description / Module	DICOM Tag	DICOM SCP Matching Key Type	DICOM SCP Return Key Type	HL7 Description	HL7 Item #	HL7 v2.3.1 Segment	HL7 v2.5.1 Segment	Notes
Pregnancy Status	(0010,21C0)	O	2	Ambulatory Status	00145	ORM PV1:15	OMG PV1:15	"B6" must be mapped to DICOM enumerated value "3" (definitely pregnant).
Medical Alerts	(0010,2000)	O	2	Relevant Clinical Info	00247	ORM OBR:13	OMG OBR:13	
Contrast Allergies	(0010,2110)	O	2	Allergy Code	00205	ADT AL1:3	ADT AL1:3	
Special Needs	(0038,0050)	O	2					
All other Attributes from the Patient Medical Module		O	3					

Adapted from DICOM PS 3.4

Notes from Table D-1:

- 7455
- **Note 1:** Universal Service ID and Specimen Source decoding:
 - In order to fulfill an accepted order, the Department System Scheduler generates one or more Requested procedures, to which it assigns IDs and proper codes, taken from either local or universal coding scheme (such as CPT-4 or LOINC)".
 - If laterality is not specified in the Universal Service ID then it is recommended to use HL7 v2.5.1 Placer Supplemental Information (01474) or HL7 v2.3.1 Specimen Source (00249) to further clarify the free format text descriptions of the Order.
- 7460
- **Note 2:** Only the suggested values of the HL7 Priority component of Quantity/Timing shall be used for IHE. These values shall be mapped to the DICOM enumerated fields for Priority as:

7465

HL7 Status	DICOM Status
S - STAT	STAT
A - ASAP	HIGH
R - Routine	ROUTINE
P - Pre-op	HIGH
C - Callback	HIGH
T - Timing	MEDIUM

- 7470

 - **Note 3:** Department System Scheduler/Order Filler shall determine the value of DICOM Modality (0008,0060) attribute based on the content of the order. The DICOM defined terms must be used for the MWL response as listed in DICOM PS 3.3.
- 7475

 - **Note 4:** Attributes (0040,2016) and (0040, 2017) are designed to incorporate the HL7 components of Placer Issuer and Number, and Filler Issuer and Number. In a healthcare enterprise with multiple issuers of patient identifiers, both the issuer name and number are required to guarantee uniqueness.
 - **Note 5:** Refer to Appendix D for a more thorough discussion on the mapping of Patient ID and Issuer of Patient ID for different use cases.
 - **Note 6:** As discussed in Section 4.1.4.1.2.4, either field PID-18 Patient Account Number or field PV1-19 Visit Number or both may be valued depending on the specific national requirements. Whenever field PV1-19 Visit Number in an order message is valued, its components shall be used to populate Admission ID (0038,0010) and Issuer of Admission ID (0038,0011) attributes in the MWL responses. In the case where field PV1-19 Visit Number is not valued, these attributes shall be valued from components of field PID-18 Patient Account Number. This requires that Visit Numbers be unique across all account numbers.
- 7480

 - **Note 7:** Patient's Weight and Patient's Size are two observations from multiple OBX segments. A coding scheme is not specified by IHE, but rather, the text values of "Body Weight" and "Body Height", respectively, are required to differentiate the two measurements. Note that DICOM specifies the use of "kg" and "m", respectively, for these measurements. An example of this HL7 encoding is:
 - OBX||ST|^BODY WEIGHT||62|kg||||F
 - OBX||ST|^BODY HEIGHT||1.90|m||||F
- 7485

 - **Note 8:** The DICOM attribute (0038, 0050) Special Needs is listed in Table D-1 with no specific mapping from an HL7 message. In the IHE demonstration, this value is to be provided by the DSS/Order Filler. The prospect of mapping this attribute to an HL7 value will be examined in the future.
- 7490

 - **Note 9:** Field OBR-34 *Technician* in ORM or OMG message is repeatable. Its data type is CM, with the following components: <name (CN)> ^ <start date/time (TS)> ^ <end date/time (TS)> ^ <point of care (IS)> ^ <room (IS)> ^ <bed (IS)> ^ <facility (HD)> ^ <location status (IS)> ^ <patient location type (IS)> ^ <building (IS)> ^ <floor (IS)>
 - Thus, in mapping value to the DICOM attribute Scheduled Performing Physician (0040,0006), only sub-components of the first component of the first repetition of that field shall be used.
- 7495

 - **Note 10:** The encoding of the patient's name in the HL7 ORM or OMG PID:5 components is mapped without changes into the DICOM components in the Patient's
- 7500

Name (0010,0010) attribute as follows:

7505

HL7	DICOM
<family_name&last_name_prefix>	=> <family_name_complex>
<given_name>	=> <given_name_complex>
<middle_initial_or_name>	=> <middle_name>
<suffix><degree>	=> <name_suffix>
<prefix>	=> <name_prefix>

7510

Note: The HL7 “degree” component is absorbed as a second element in the “name_suffix” component in DICOM.

7515

- **Note 11:** The DICOM Patient’s Sex (0010,0040) attribute can have only the values M, F or O (for other), or be zero length if unknown. These are enumerated values and hence any other values would be illegal. The HL7 V2 description also uses M, F and O, but suggests a value of U for unknown, which needs to be mapped to zero length. In HL7 these are only suggested values however, and care should be taken to map any other values encountered to valid DICOM values. Note also that in HL7 V2.5.1, the additional suggested values of A meaning Ambiguous and N meaning Not applicable, are present, and again, these would be illegal in DICOM and need to be mapped to O.

7520

- **Note 12:** National requirements for character set values are defined below (see RAD TF-4 for further national extensions):

7525

National Extension	DICOM attribute: Specific Character Set (0008,0005)	HL7 field: Character Set MSH 18
France	ISO_IR 100	8859/1
Germany	ISO_IR 100	8859/1
United States	ISO_IR 100	8859/1
Italy	ISO_IR 100	8859/1
UK	ISO_IR 100	8859/1
Canada	ISO_IR 100	8859/1
Spain	ISO_IR 100	8859/1
Japan	\ISO 2022 IR 87	ASCII~ISO IR87

Appendix C: Departmental Access to Non-Radiology Information

7530 C.1: Scope

The access to non-radiology reports external to the imaging department is supported in the IHE Technical Framework by leveraging the Query Reports and Retrieve Reports Transactions also used to access imaging department Structured Reports (see Sections 4.26 and 4.27). The External Report Repository Access provides a method to retrieve from the other department's reports (e.g., Laboratory).

7535

The IHE Radiology Technical Framework does not restrict the manner in which this External Report Repository Access is implemented. It may, for example:

- Be a Laboratory Repository System that directly supports this actor and the associated Query Reports and Retrieve Reports Transactions;
- Accept the Query Reports and Retrieve Reports Transactions on one side and translate them into another query transaction supported by a specific laboratory report repository.

7540

This appendix discusses the constraints that this External Report Repository Access needs to support for its proper integration.

C.2: Query Protocol

7545 The assumptions under which the External Report Repository Access operates are:

1. The External Report Repository Access is responsible for formatting other department reports (e.g., laboratory report) into a DICOM Structured Report object (for content constraints see Section C.3). The prime focus for the IHE Technical Framework will be laboratory reports, although other department's reports may be supported.
- 7550 2. Consistent Patient IDs will be used in the laboratory (or other) department reports and in the imaging department. This will ensure that a Patient ID of an image displayed by an Image Display can be used as a key to retrieve recent laboratory reports for the same patient. This implies that the laboratory information system is integrated with the same ADT Patient Registration (although this integration is not within the scope of the IHE Radiology Technical Framework).
- 7555 3. The Study and Series groupings are not specified by the IHE Radiology Technical Framework and may be arbitrarily used by the External Report Repository Access. For example, a DICOM Study may be created for each order (Accession Number) that contains one or more laboratory reports, a Series may be created for each laboratory request and so may contain mostly one report, unless amended. Alternatively, a single Series may be created and contain multiple reports if different laboratory exams were requested in the same order.
- 7560 4. Study Instance UIDs, Series Instance UIDs and SOP Instance UIDs may be created by the External Report Repository Access to group one or more of its Reports. Those UIDs need to be properly formed DICOM UIDs, i.e., use a registered root.
- 7565 5. If the same Report is being queried and retrieved several times, the same set of Study, Series and SOP Instance UIDs shall be provided by the External Report Repository Access. This

ensures that two separate queries selecting the same report will identify the same instance and retrieve an identical copy. This is important to avoid multiple copies with the same content confusing the clinician.

- 7570 6. Table C.2-1 shows the minimal set of matching and return keys that shall be supported by the External Report Repository Access as an SCP at the different DICOM Hierarchical Levels. It is a reduced set from the radiology department keys (see sections 4.14.4.1.2). Additional SR Instance specific keys that shall be supported by the External Report Repository Access as an SCP are defined in Section 4.26.4.1.2 and Table 4.26-1. Minimum DICOM conformance is still required. Conventions for Table C.2-1 may be found in Section 2.2.

7575

Note: The use of N/A (Not Applicable) in the SCU columns is because the External Report Repository Access is only an SCP of the query request.

Table C.2-1: Query Matching and Return Keys

Attributes Name	Tag	Query Keys Matching		Query Keys Return		Notes
		SCU	SCP	SCU	SCP	
Study Level						
Study Date	(0008,0020)	N/A	R	N/A	R	
Study Time	(0008,0030)	N/A	R	N/A	R	
Accession Number	(0008,0050)	N/A	R	N/A	R	
Patient Name	(0010,0010)	N/A	R	N/A	R	IHE-1, IHE-2
Patient ID	(0010,0020)	N/A	R	N/A	R	
Study ID	(0020,0010)	N/A	R	N/A	R	
Study Instance UID	(0020,000D)	N/A	R	N/A	R	
Referring Physician's Name	(0008,0090)	N/A	R+	N/A	R+	IHE-1, IHE-2
Study Description	(0008,1030)	N/A	O	N/A	O	
Procedure Code Sequence	(0008,1032)	N/A	O	N/A	O	IHE-3
Patient's Birth Date	(0010,0030)	N/A	O	N/A	R+	
Patient's Sex	(0010,0040)	N/A	O	N/A	R+	
Series Level						
Modality	(0008,0060)	N/A	R	N/A	R	IHE-5
Series Number	(0020,0011)	N/A	R	N/A	R	
Series Instance UID	(0020,000E)	N/A	R	N/A	R	
Composite Object Instance Level						
Instance Number	(0020,0013)	N/A	R	N/A	R	
SOP Instance UID	(0008,0018)	N/A	R	N/A	R	
SOP Class UID	(0008,0016)	N/A	R+	N/A	R+	IHE-4

- 7580
 - **IHE-1:** Case insensitive matching is allowed in the IHE Radiology Technical Framework, for attributes of VR PN. A DICOM Change Proposal (CP 190) to allow case insensitivity on PN attributes was balloted in DICOM 2001
 - **IHE-2:** SCUs are recommended to append wildcard “*” at the end of each component of any structured name to facilitate matching (i.e., PN attributes).
- 7585
 - **IHE-3:** Universal Matching (selecting return keys) against an Attribute of VR SQ may be requested by the Query SCU using a Zero Length Sequence Attribute. Query SCPs shall accept such Universal Match Requests. In addition, Query SCPs are required by the DICOM Standard to support requests for a Universal Match for an SQ attribute encoded as a zero length item.
- 7590
 - **IHE-4:** A SOP Class UID is a non-ambiguous key to identify a specific type of image (Modality is not).
 - **IHE-5:** The Modality Matching Key will always be set to “SR”

C.3: External Report Content

7595 The requirements for coded entries and report structure for reports handled by the External Report Repository via the Query Reports and Retrieve Reports Transactions shall be similar to the Report Creator (see Section 4.24.4.1.2.1):

- 7600
 - The types of reports generated by the External Report Repository are defined in RAD TF-1:9.4. The External Report Repository shall be able to generate reports based on the Simple Image Report (RAD TF-1: 9.4.1) with optional image references. If the External Report Repository supports the Enhanced SR Information Object Definition then it shall also support the generation of Simple Image and Numeric Reports (RAD TF-1: 9.4.2).
 - 7605
 - A specialized set of Report Titles, Report Section Headings, Concept Name Codes, Observation Context Codes, Measurement Codes and Disposition or Conclusion Codes will be defined for each type of department repository accessed (e.g., laboratory codes for laboratory departments)

Appendix D: Clarification of Patient Identifiers for Merge Cases

D.1: Introduction

7610 IHE Technical Framework has adopted the changes in HL7 v2.3.1 and HL7 v2.5.1 Patient Identifiers. This includes:

- External Patient ID (PID-2) has been retained for backward compatibility.
- Alternate Patient ID (PID-4) has been retained for backward compatibility.
- Internal Patient ID (PID-3) has been renamed “Patient Identifier List” and is now allowed to repeat.

7615 Due to the adoption of these HL7 changes, IHE mandates the use of assigning authority (issuer) in PID-3 component 4 and identifier in PID-3 component 1.

7620 Since the DICOM Patient ID attribute (0010,0020) does not convey assigning authority and the Issuer of Patient ID (0010,0021) is an optional attribute in DICOM, both the Image Manager and the Department System Scheduler/Order Filler shall be prepared to make assumptions regarding the assigning authority for Patient IDs transmitted from a Modality via DICOM Modality PPS. It is assumed that it is possible to recognize a valid range of patient identifiers assigned by a single ADT or a single issuer of identifiers within an enterprise.

7625 The identifier in PID-3 in all HL7 transactions specified by the IHE shall be single valued and used by the ADT/Patient Registration, except for Transaction RAD-4 which may use an identifier assigned by the DSS/Order Filler.

In future years of IHE with the introduction of an MPI, it is assumed that the MPI identifier will be used in PID-3 for all HL7 transactions.

7630 It is required that the healthcare institution configure the issuer of temporary patient identifiers to be either the ADT Issuer or the Departmental Issuer in both the Image Manager and the DSS/Order Filler. This will ensure that Patient ID in DICOM (0010,0020) is associated with the same assigning authority when mapped into a PID-3 in HL7 messages.

7635 Although, an organization may operate with temporary patient identifiers issued by the ADT and used primarily in Cases 1, 2 and 3, Case 5 may occur. This may happen due to Modality operator errors when manually entering patient identifier in Case 3. In this situation, DSS/Order Filler and Image Manager shall recognize the error and associate the erroneous identifier to the same issuer. The reconciliation will happen on the DSS/Order Filler and it will send the Patient Merge message to the Image Manager where both “new” and “old” patient identifiers are associated with the same issuer.

7640 The use of PID-3 is illustrated in the following sections using the use cases from RAD TF-1: 3.3, 4.3. In the examples given below time flows from the top row of the table to the bottom.

Table Acronyms	Description
IM	Image Manager
OF	Order Filler / Departmental System Scheduler
OP	Order Placer
PPSM	Performed Procedure Step Manager

D.2: Administrative Process Flow (RAD TF-1: 3.3.1)

The illustration includes A01, A04, A05, A11, and A30 although only an A01 is included in this example. The ADT identifier number used in the example below is “123”, the assigning authority is “ADT_Issuer”.

7645

Transaction	PID-3 (Patient Identifier List)	DICOM (0010,0020)	MRG-1 (Prior Patient Identifier List)
A01 (ADT -> OF)	123^^^ADT_Issuer	N/A	N/A
A01 (ADT -> OP)	123^^^ADT_Issuer	N/A	N/A
ORM (OP->OF) (HL7 v.2.3.1) OMG (OP->OF) (HL7 v2.5.1)	123^^^ADT_Issuer	N/A	N/A
ORM (OF->IM) (HL7 v2.3.1) OMG (OF->IM) (HL7 v2.5.1)	123^^^ADT_Issuer	N/A	N/A
DICOM MWL (OF -> Modality)	N/A	123	N/A
PPS (Modality -> PPSM)	N/A	123	N/A
PPS (PPSM -> IM)	N/A	123	N/A
PPS (PPSM -> OF)	N/A	123	N/A

D.3: Patient Merge (RAD TF-1: 3.3.2)

This specifically looks at the Patient merge scenario in RAD TF-1: 3.3.2.2. The “old” ADT identifier number used in the example below is “123”, the assigning authority is “ADT_Issuer”. The “new” ADT identifier number used in the example below is “456”, the assigning authority is “ADT_Issuer”.

7650

Transaction	PID-3 (Patient Identifier List)	DICOM (0010,0020)	MRG-1 (Prior Patient Identifier List)
A01 (ADT -> OF)	123^^^ADT_Issuer	N/A	N/A
A01 (ADT -> OP)	123^^^ADT_Issuer	N/A	N/A
ORM (OP->OF) (HL7 v.2.3.1) OMG (OP->OF) (HL7 v2.5.1)	123^^^ADT_Issuer	N/A	N/A
ORM (OF->IM) (HL7 v2.3.1) OMG (OF->IM) (HL7 v2.5.1)	123^^^ADT_Issuer	N/A	N/A

Transaction	PID-3 (Patient Identifier List)	DICOM (0010,0020)	MRG-1 (Prior Patient Identifier List)
DICOM MWL (OF -> Modality)	N/A	123	N/A
A40 (ADT -> OF)	456^^^ADT_Issuer	N/A	123^^^ADT_Issuer
A40 (OF->IM)	456^^^ADT_Issuer	N/A	123^^^ADT_Issuer
A40 (ADT -> OP)	456^^^ADT_Issuer	N/A	123^^^ADT_Issuer

D.4: Trauma Cases 1 and 2 (RAD TF-1: 4.3)

7655 The ADT temporary identifier for “John Doe” used in the example below is “Temp_123”, the assigning authority is “ADT_Issuer”.

Transaction	PID-3 (Patient Identifier List)	DICOM (0010,0020)	MRG-1 (Prior Patient Identifier List)
A01 (ADT -> OF)	Temp_123^^^ADT_Issuer	N/A	N/A
A01 (ADT -> OP)	Temp_123^^^ADT_Issuer	N/A	N/A
ORM (OP->OF) (HL7 v.2.3.1) OMG (OP->OF) (HL7 v2.5.1)	Temp_123^^^ADT_Issuer	N/A	N/A
ORM (OF->IM) (HL7 v2.3.1) OMG (OF->IM) (HL7 v2.5.1)	Temp_123^^^ADT_Issuer	N/A	N/A
DICOM MWL (OF -> Modality)	N/A	Temp_123	N/A
PPS (Modality -> PPSM)	N/A	Temp_123	N/A
PPS (PPSM -> IM)	N/A	Temp_123	N/A
PPS (PPSM -> OF)	N/A	Temp_123	N/A
A40 (ADT -> OF)	456^^^ADT_Issuer	N/A	Temp_123^^^ADT_Issuer
A40 (OF->IM)	456^^^ADT_Issuer	N/A	Temp_123^^^ADT_Issuer
A40 (ADT -> OP)	456^^^ADT_Issuer	N/A	Temp_123^^^ADT_Issuer

D.5: Trauma Case 3 (RAD TF-1: 4.3)

7660 The ADT temporary identifier number for “John Doe” used in the example below is “Temp_123”. The patient will later be assigned a permanent identifier of “Real_456”, the assigning authority is “ADT_Issuer”.

Transaction	PID-3 (Patient Identifier List)	DICOM (0010,0020)	MRG-1 (Prior Patient Identifier List)
A01 (ADT -> OF)	Temp_123^^^ADT_Issuer	N/A	N/A

Transaction	PID-3 (Patient Identifier List)	DICOM (0010,0020)	MRG-1 (Prior Patient Identifier List)
A01 (ADT -> OP)	Temp_123^^^ADT_Issuer	N/A	N/A
(Note: Temporary Patient ID “Temp_123” is manually entered at the modality.)	N/A	N/A	N/A
PPS (Modality -> PPSM)	N/A	Temp_123	N/A
PPS (PPSM -> IM)	N/A	Temp_123	N/A
(Note: The IM recognizes an unscheduled PPS and assumes a site configured assigning authority of “ADT_Issuer”.)	N/A	N/A	N/A
PPS (PPSM -> OF)	N/A	Temp_123	N/A
(Note: The OF recognizes an unscheduled PPS with a valid ADT Patient ID – with a site configured assigning authority of “ADT_Issuer”.)	N/A	N/A	N/A
ORM (OF-> OP) (HL7 v2.3.1) OMG (OP->OF) (HL7 v2.5.1)	Temp_123^^^ADT_Issuer	N/A	N/A
ORR (OP->OF) (HL7 v2.3.1) ORG (OP->OF) (HL7 v2.5.1)	Temp_123^^^ADT_Issuer	N/A	N/A
ORM (OF-> IM) (HL7 v2.3.1) OMI (OF->IM) (HL7 v2.5.1)	Temp_123^^^ADT_Issuer	N/A	N/A
(Note: Patient Reconciliation occurs on the ADT system.)	N/A	N/A	N/A
A40 (ADT -> OF)	Real_456^^^ADT_Issuer	N/A	Temp_123^^^ADT_Issuer
A40 (ADT -> OP)	Real_456^^^ADT_Issuer	N/A	Temp_123^^^ADT_Issuer
A40 (OF-> IM)	Real_456^^^ADT_Issuer	N/A	Temp_123^^^ADT_Issuer

D.6: Trauma Case 4 (RAD TF-1: 4.3)

The OF temporary identifier number for “John Doe” used in the example below is “Dept_789”. The Patient will later be assigned a permanent identifier of “123”, the assigning authority is “OF_Issuer”.

7665

Transaction	PID-3 (Patient Identifier List)	DICOM (0010,0020)	MRG-1 (Prior Patient Identifier List)
ORM (OF->IM)	Dept_789^^^OF_Issuer	N/A	N/A
DICOM MWL (OF->Modality)	N/A	Dept_789	N/A

Transaction	PID-3 (Patient Identifier List)	DICOM (0010,0020)	MRG-1 (Prior Patient Identifier List)
PPS (Modality -> PPSM)	N/A	Dept_789	N/A
PPS (PPSM -> IM)	N/A	Dept_789	N/A
(Note: The IM recognizes a scheduled PPS with a Patient ID - with a site configured assigning authority of "OF_Issuer".)	N/A	N/A	N/A
PPS (PPSM -> OF)	N/A	Dept_789	N/A
(Note: The OF recognizes a scheduled PPS with a Patient ID issued by the OF.)	N/A	N/A	N/A
A01 (ADT -> OP)	123^^^ADT_Issuer	N/A	N/A
A01 (ADT -> OF)	123^^^ADT_Issuer	N/A	N/A
(Note: The patient Dept_789^^^OF_Issuer is manually reconciled with 123^^^ADT_Issuer.)	N/A	N/A	N/A
A40 (OF-> IM)	123^^^ADT_Issuer	N/A	Dept_789^^^OF_Issuer
ORM (OF-> IM) (HL7 v2.3.1) OMI (OF->IM) (HL7 v2.5.1)	123^^^ADT_Issuer	N/A	N/A
ORM (OF-> OP) (HL7 v2.3.1) OMG (OP->OF) (HL7 v2.5.1)	123^^^ADT_Issuer	N/A	N/A
ORR (OP->OF) (HL7 v2.3.1) ORG (OP->OF) (HL7 v2.5.1)	123^^^ADT_Issuer	N/A	N/A

D.7: Trauma Case 5 (RAD TF-1: 4.3)

The temporary identifier number for "John Doe" used in the example below is "Dept_123" and is manually entered on the Modality. The patient will later be assigned a permanent identifier of "Real_456", the assigning authority is "OF_Issuer".

7670

Transaction	PID-3 (Patient Identifier List)	DICOM (0010,0020)	MRG-1 (Prior Patient Identifier List)
PPS (Modality -> PPSM)	N/A	Dept_123	
PPS (PPSM->IM)	N/A	Dept_123	N/A
(Note: The IM recognizes an unscheduled PPS and assumes a site configured assigning authority)	N/A	N/A	N/A
PPS (PPSM->OF)	N/A	Dept_123	N/A

Transaction	PID-3 (Patient Identifier List)	DICOM (0010,0020)	MRG-1 (Prior Patient Identifier List)
(Note: The OF recognizes an unscheduled PPS and assumes a site configured assigning authority; recognizes that Patient ID is invalid.)	N/A	N/A	N/A
A01 (ADT->OF)	Real_456^^^ADT_Issuer	N/A	N/A
A01 (ADT->OP)	Real_456^^^ADT_Issuer	N/A	N/A
(Note: Manual patient reconciliation occurs on the OF system.)	N/A	N/A	N/A
A40 (OF-> IM)	Real_456^^^ADT_Issuer	N/A	Dept_123^^^Configured_Issuer
ORM (OF-> OP) (HL7 v2.3.1) OMG (OP->OF) (HL7 v2.5.1)	Real_456^^^ADT_Issuer	N/A	N/A
ORR (OP->OF) (HL7 v2.3.1) ORG (OP->OF) (HL7 v2.5.1)	Real_456^^^ADT_Issuer	N/A	N/A
ORM (OF-> IM) (HL7 v2.3.1) OMI (OF->IM) (HL7 v2.5.1)	Real_456^^^ADT_Issuer	N/A	N/A

Appendix E: HL7 Version 2.3.1 Message Field Replaced with HL7 Version 2.5.1 Summary

7675 This appendix provides for a summary of the overloaded and/or obsolete message fields profiled in the HL7 v2.3.1 message semantics in this Radiology Technical Framework and the replacement message fields profiled in the HL7 v2.5.1 Option. Note that the original semantics specified by the IHE Radiology Technical Framework are maintained when implementing HL7 v2.5.1. Refer to the transaction description in the Technical Framework for the detailed description. This table is provided for your reference.

7680

E.1: RAD-1 Patient Registration/RAD-12 Patient Update

ADT Version 2.3.1			ADT Version 2.5.1		
Segment	SEQ	Element Name	Segment	SEQ	Element Name
PV1	9	Consulting Doctor	ROL	4	ROLE-Person

E.2: RAD-2 Place Order Management/RAD-3 Filler Order Management

ORM/ORR Version 2.3.1			OMG/ORG Version 2.5.1		
Segment	SEQ	Element Name	Segment	SEQ	Element Name
PV1	9	Consulting Doctor	ROL	4	ROLE-Person
ORC	7	Timing/Quantity	TQ1	7	Start Time Date

E.3: RAD-4 Procedure Scheduled/RAD-13 Procedure Update

ORM Version 2.3.1			OMI Version 2.5.1		
Segment	SEQ:<comp>	Element Name	Segment	SEQ	Element Name
PV1	9	Consulting Doctor	ROL	4	ROLE-Person
ORC	7	Timing/Quantity	TQ1	7	Start Time Date
ZDS	1	Study Instance UID	IPC	3	Study Instance UID
OBR	4:4-6	Universal Service ID	IPC	6	Protocol Code
OBR	15	Specimen Source	OBR	46	Placer Supplemental Service Information
OBR	16	Placer Field 1	IPC	1	Accession Identifier
OBR	19	Placer Field 2	IPC	2	Requested Procedure ID
OBR	20	Filler Field 1	IPC	4	Scheduled Procedure Step ID
OBR	24	Diagnostic Service ID	IPC	5	Modality

7685 **GLOSSARY**

See RAD TF-1: Appendix E, which contains a comprehensive glossary for this document.