



5 **IHE Quality, Research and Public Health
Technical Framework Supplement**

10 **Mobile Retrieve Form for Data Capture
(mRFD)**

HL7[®] FHIR[®] STU 4

15 Using Resources at FMM Level Normative

Rev. 2.1 – Trial Implementation

20 Date: August 30, 2019
Author: QRPH Technical Committee
Email: QRPH@ihe.net

25 **Please verify you have the most recent version of this document. See [here](#) for Trial
Implementation and Final Text versions and [here](#) for Public Comment versions.**

Foreword

30 This is a supplement to the IHE Quality, Research and Public Health (QRPH) Technical Framework. Each supplement undergoes a process of public comment and trial implementation before being incorporated into the volumes of the Technical Frameworks.

This supplement is published on August 30, 2019 for trial implementation and may be available for testing at subsequent IHE Connectathons. The supplement may be amended based on the results of testing. Following successful testing it will be incorporated into the QRPH Technical Framework. Comments are invited and may be submitted at
35 http://www.ihe.net/QRPH_Public_Comments.

“Boxed” instructions like the sample below indicate to the Volume Editor how to integrate the relevant section(s) into the relevant Technical Framework volume.

<i>Amend Section X.X by the following:</i>
--

40 Where the amendment adds text, make the added text **bold underline**. Where the amendment removes text, make the removed text **~~bold strikethrough~~**. When entire new sections are added, introduce with editor’s instructions to “add new text” or similar, which for readability are not bolded or underlined.

General information about IHE can be found at www.ihe.net.

45 Information about the IHE Quality Research and Public Health domain can be found at ihe.net/IHE_Domains.

Information about the organization of IHE Technical Frameworks and Supplements and the process used to create them can be found at http://ihe.net/IHE_Process and <http://ihe.net/Profiles>.

50 The current version of the IHE Quality Research and Public Health Technical Framework can be found at http://ihe.net/Technical_Frameworks.

CONTENTS

	Introduction to this Supplement.....	7
55	Open Issues and Questions	7
	Closed Issues	8
	General Introduction	9
	Appendix A – Actor Summary Definitions	9
	Appendix B – Transaction Summary Definitions.....	9
60	Glossary	9
	Volume 1 – Profiles	11
	X Mobile Retrieve Form for Data Capture (mRFD) Profile.....	12
	X.1 mRFD Actors, Transactions, and Content Modules	12
	X.1.1 Actor Descriptions and Actor Profile Requirements.....	14
65	X.1.1.1 Form Filler	14
	X.1.1.2 Form Manager	14
	X.1.1.3 Data Responder.....	15
	X.2 mRFD Actor Options	15
	X.2.1 Expected Data Responder	15
70	X.3 mRFD Required Actor Groupings	16
	X.4 mRFD Overview	16
	X.4.1 Concepts	16
	X.4.1.1 Structural Differences Between Profiles	16
	X.4.1.2 Prepopulation, Autopopulation and Querypopulation.....	17
75	X.4.1.2.1 Prepopulation	17
	X.4.1.2.2 Autopopulation	18
	X.4.1.2.3 Querypopulation	18
	X.4.1.2.4 Which Approach to Use.....	18
	X.4.1.2.5 Side by Side Workflow Comparison	19
80	X.4.1.3 Data Submission	20
	X.4.1.4 Form Selection.....	21
	X.4.1.5 Additional Data Gathering.....	21
	X.4.2 Use Cases	22
	X.4.2.1 Use Case #1: Research Enrollment	22
85	X.4.2.1.1 Research Enrollment Use Case Description	22
	X.4.2.1.2 Research Enrollment Process Flow	22
	X.4.2.2 Use Case #2: Public Health Enrollment	25
	X.4.2.2.1 Public Health Enrollment Use Case Description.....	25
	X.4.2.2.2 Public Health Enrollment Process Flow	25
90	X.5 mRFD Security Considerations.....	28
	X.5.1 Consistent Time (CT).....	29
	X.5.2 Audit Trail and Node Authentication (ATNA).....	29
	X.5.3 User Authorization	30

	X.5.4 Consent.....	30
95	X.5.5 Additional RESTful Query Considerations.....	30
	X.5.6 Related Document Sharing.....	30
	X.5.7 Demographic Query	30
	X.6 mRFD Cross Profile Considerations.....	31
	Volume 2 – Transactions.....	32
100	3.48 Mobile Retrieve Form [QRPH-48]	32
	3.48.1 Scope	32
	3.48.2 Actor Roles.....	32
	3.48.3 Referenced Standards.....	32
	3.48.4 Messages	33
105	3.48.4.1 Mobile Retrieve Form Request	33
	3.48.4.1.1 Trigger Events	33
	3.48.4.1.2 Message Semantics.....	33
	3.48.4.1.2.1 Mobile Retrieve Form Request Parameters	34
	3.48.4.1.3 Expected Actions.....	34
110	3.48.4.2 Mobile Retrieve Form Response	34
	3.48.4.2.1 Trigger Events	34
	3.48.4.2.2 Message Semantics.....	34
	3.48.4.2.2.1 Mobile Retrieve Form Response Parameters.....	35
	3.48.4.2.3 Expected Actions	36
115	3.48.5 Security Considerations.....	36
	3.48.5.1 Security Audit Considerations.....	36
	3.49 Mobile Retrieve Capability [QRPH-49]	36
	3.49.1 Scope	36
	3.49.2 Actor Roles.....	36
120	3.49.3 Referenced Standards.....	37
	3.49.4 Messages	37
	3.49.4.1 Mobile Retrieve Capability Request	38
	3.49.4.1.1 Trigger Events	38
	3.49.4.1.2 Message Semantics.....	38
125	3.49.4.1.2.1 Mobile Retrieve Capability Request Parameters	38
	3.49.4.1.3 Expected Actions.....	38
	3.49.4.2 Mobile Retrieve Capability Response	38
	3.49.4.2.1 Trigger Events	38
	3.49.4.2.2 Message Semantics.....	38
130	3.49.4.2.2.1 Mobile Retrieve Capability Response Parameters.....	40
	3.49.4.2.3 Expected Actions	40
	3.49.5 Security Considerations.....	41
	3.49.5.1 Security Audit Considerations.....	41
	3.50 Mobile Authorize Form [QRPH-50].....	41
135	3.50.1 Scope	41
	3.50.2 Actor Roles.....	41

	3.50.3 Referenced Standards.....	42
	3.50.4 Messages	42
140	3.50.4.1 Mobile Authorize Form Request	42
	3.50.4.1.1 Trigger Events	43
	3.50.4.1.2 Message Semantics.....	43
	3.50.4.1.2.1 Mobile Authorize Form Request Parameters.....	43
	3.50.4.1.3 Expected Actions	43
	3.50.4.2 Mobile Authorize Form Response.....	43
145	3.50.4.2.1 Trigger Events	43
	3.50.4.2.2 Message Semantics.....	43
	3.50.4.2.2.1 Mobile Authorize Form Response Parameters	44
	3.50.4.2.3 Expected Actions	44
	3.50.5 Security Considerations.....	44
150	3.50.5.1 Security Audit Considerations.....	44
	3.51 Mobile Retrieve Access Token [QRPH-51]	44
	3.51.1 Scope	45
	3.51.2 Actor Roles.....	45
	3.51.3 Referenced Standards	45
155	3.51.4 Messages	46
	3.51.4.1 Mobile Retrieve Access Token Request.....	46
	3.51.4.1.1 Trigger Events	46
	3.51.4.1.2 Message Semantics.....	46
	3.51.4.1.2.1 Mobile Retrieve Access Token Request Parameters	47
160	3.51.4.1.3 Expected Actions	47
	3.51.4.2 Mobile Retrieve Access Token Response	47
	3.51.4.2.1 Trigger Events	47
	3.51.4.2.2 Message Semantics.....	47
	3.51.4.2.2.1 Mobile Retrieve Access Token Response Parameters.....	48
165	3.51.4.2.3 Expected Actions	49
	3.51.5 Security Considerations.....	49
	3.51.5.1 Security Audit Considerations.....	49
	3.52 Mobile Populate Form [QRPH-52].....	49
	3.52.1 Scope	49
170	3.52.2 Actor Roles.....	49
	3.52.3 Referenced Standards	50
	3.52.4 Messages	51
	3.52.4.1 Mobile Populate Form Request	51
	3.52.4.1.1 Trigger Events	51
175	3.52.4.1.2 Message Semantics.....	51
	3.52.4.1.2.1 Mobile Populate Form Request Parameters.....	51
	3.52.4.1.3 Expected Actions	52
	3.52.4.2 Mobile Populate Form Response.....	52
	3.52.4.2.1 Trigger Events	52

180	3.52.4.2.2 Message Semantics.....	52
	3.52.4.2.2.1 Mobile Populate Form Response Parameters	53
	3.52.4.2.3 Expected Actions	54
	3.52.5 Security Considerations.....	54
	3.52.5.1 Security Audit Considerations.....	54
185	Appendices.....	55
	Volume 3 – Content Modules.....	56
	5 Namespaces and Vocabularies.....	56
	6 Content Modules.....	56
	Appendices.....	57
190	Volume 4 – National Extensions	58

Introduction to this Supplement

195 Whenever possible, IHE profiles are based on established and stable underlying standards. However, if an IHE domain determines that an emerging standard has high likelihood of industry adoption, and the standard offers significant benefits for the use cases it is attempting to address, the domain may develop IHE profiles based on such a standard. During Trial Implementation, the IHE domain will update and republish the IHE profile as the underlying standard evolves.

200 Product implementations and site deployments may need to be updated in order for them to remain interoperable and conformant with an updated IHE profile.

This mRFD Profile is based on Release 4 of the emerging HL7^{®1} FHIR^{®2} specification. HL7 describes FHIR Change Management and Versioning at <https://www.hl7.org/fhir/versions.html>.

205 HL7 provides a rating of the maturity of FHIR content based on the FHIR Maturity Model (FMM): level 0 (draft) through N (Normative). See <http://hl7.org/fhir/versions.html#maturity>.

The FMM levels for FHIR content used in this profile are:

FHIR Resource Name	FMM Level
CapabilityStatement	Normative

210 Note: Even though only CapabilityStatement is referenced in this profile, the mRFD Profile allows access to other resources or Bundles of resources supported by the actors and that are necessary to the use case. The CapabilityStatement will include references to other supported resources.

215 The Mobile Retrieve Form for Data Capture (mRFD) Profile provides a method for gathering data within a user’s current application to meet the requirements of an external system. mRFD supports RESTful retrieval of forms from a form source, display and completion of a form, and return of instance data from the display application to the source application. The workflows defined in this profile are based on those defined by the Retrieve Form for Data Capture (RFD) Profile.

220

Open Issues and Questions

1. SMART on FHIR allows two different launch methodologies. The “EHR Launch” method is similar to the original RFD Profile’s approach to filling out forms. That is the

¹ HL7 is the registered trademark of Health Level Seven International.

² FHIR is the registered trademark of Health Level Seven International.

- 225 approach that has been adapted into mRFD. The “Standalone Launch” approach is not included, but may be considered for inclusion at a later time.
2. When a Data Responder is working closely with a Form Filler, the OAuth2 “Authorization Flow” is what is used, as described here in mRFD. For Data Responders that have a pre-arranged agreement with a Form Manager, they would instead use the “client credentials” or “SMART backend Services” method of integration. That method
230 has not been profiled into mRFD at this time and may be considered for inclusion at a later time.
3. There is a significant discussion within this profile of the differences and utility of RFD, SDC and mRFD. It would be good to consider moving that discussion into a standalone whitepaper or other work item once mRFD is published.
- 235 4. There are some references in this profile to the SMART on FHIR Argonaut Project (<http://docs.smarthealthit.org/authorization/>). Implementation materials may be found there, as well as additional informative resources. As HL7 ballots SMART on FHIR, references to the Argonauts SMART Health IT will be replaced with HL7 normative references.

240 **Closed Issues**

1. SMART on FHIR has, at the time of this document’s writing, not been updated to FHIR STU3. There are still references to retrieval of the conformance resource, which does not exist in STU3.
- 245 a. As IHE moves forward, profiles are moving toward being STU3 compliant. The corresponding transaction in mRFD has therefore been updated for STU3. As the transaction is optional, this may not affect some Data Responder systems that are still using some STU2 resources.
2. There is no reliable mapping available at this time between CDA and FHIR resources. There has been interest in making CDA and FHIR backwards compatible
250 (<http://hl7.org/fhir/us/ccda/2016Sep/>).
- a. mRFD’s approach is to allow retrieval of a CDA using the requisite FHIR resource. In doing so, any existing RFD derivation rules for CDA can be implemented alongside the FHIR launch.

255 **General Introduction**

Appendix A – Actor Summary Definitions

Actor	Definition
Data Responder	A Data Responder is a system that may have information that can be used by a Form Manager in preparation of form data. It is available to respond to RESTful queries from trusted Form Manager systems.
Form Filler	A Form Filler is a system that needs to complete forms that are managed by an external entity.
Form Manager	A Form Manager is a system that maintains form definitions and can provide them to systems that need to fill them out.

Appendix B – Transaction Summary Definitions

Transaction	Definition
Mobile Authorize Form [QRPH-50]	This transaction is used to authorize the relationship between the actors.
Mobile Populate Form [QRPH-52]	This transaction is used to retrieve data to fill out fields in a form.
Mobile Retrieve Access Token [QRPH-51]	This transaction is used to retrieve initial access to fill out fields in a form.
Mobile Retrieve Capability [QRPH-49]	This transaction is used to retrieve a statement of behaviors from the Data Responder.
Mobile Retrieve Form [QRPH-48]	This transaction is used to request a form that needs to be completed.

260 **Glossary**

Glossary Term	Definition
Autopopulate	This term is used in the Structured Data Capture (SDC) Profile to define content that is pulled into a form by a Form Filler. This contrasts against Prepopulate (RFD) and Querypopulate (mRFD)
Clinical Document Architecture (CDA ³)	This term is used to describe conformance of an XML document against a variety of industry standards.
Electronic Health Record (EHR)	This term is used to describe a system that maintains a longitudinal view of a patient’s history. It contains comprehensive information on a patient’s health.
Electronic Medical Record (EMR)	This term is used to describe a system that maintains a narrow view of a patient’s history. It is primarily used by providers to diagnose and treat conditions.
Prepopulate	This term is used in the Retrieve Form for Data Capture (RFD) Profile to define content that is submitted by a Form Filler and used to populate a form before an end user needs to fill in data. This contrasts against Autopopulate (SDC) and Querypopulate (mRFD)

³ CDA is the registered trademark of Health Level Seven International.

IHE Quality, Research and Public Health Technical Framework Supplement – Mobile Retrieve Form for Data Capture (mRFD)

Glossary Term	Definition
Querypopulate	This term is used in this profile to define content that is populated into a form via use of RESTful queries to systems that may contain that discrete information. This contrasts against Autopopulate (SDC) and Prepopulate (RFD).
Research Management System (RMS)	This term is used to describe a system that manages research information related to clinical trials or studies.

Volume 1 – Profiles

X Mobile Retrieve Form for Data Capture (mRFD) Profile

265 The Mobile Retrieve Form for Data Capture (mRFD) Profile provides a method for gathering data within a user’s current application to meet the requirements of an external system. mRFD supports the retrieval of forms from a form source, display and completion of a form, and return of instance data from the display application to the source application.

X.1 mRFD Actors, Transactions, and Content Modules

270 This section defines the actors, transactions, and/or content modules in this profile. General definitions of actors are given in the Technical Frameworks General Introduction Appendix A at http://ihe.net/TF_Intro_Appendices.aspx.

275 The mRFD Profile supports RESTful versions of the transactions in the basic RFD Profile, including Mobile Retrieve Form, Mobile Submit Form and Mobile Archive Form. It also introduces a transaction for use in authenticating the actors and populating forms.

Figure X.1-1 shows the actors directly involved in the mRFD Profile and the relevant transactions between them. If needed for context, other actors that may be indirectly involved due to their participation in other related profiles are shown in dotted lines. Actors which have a mandatory grouping are shown in conjoined boxes.

280

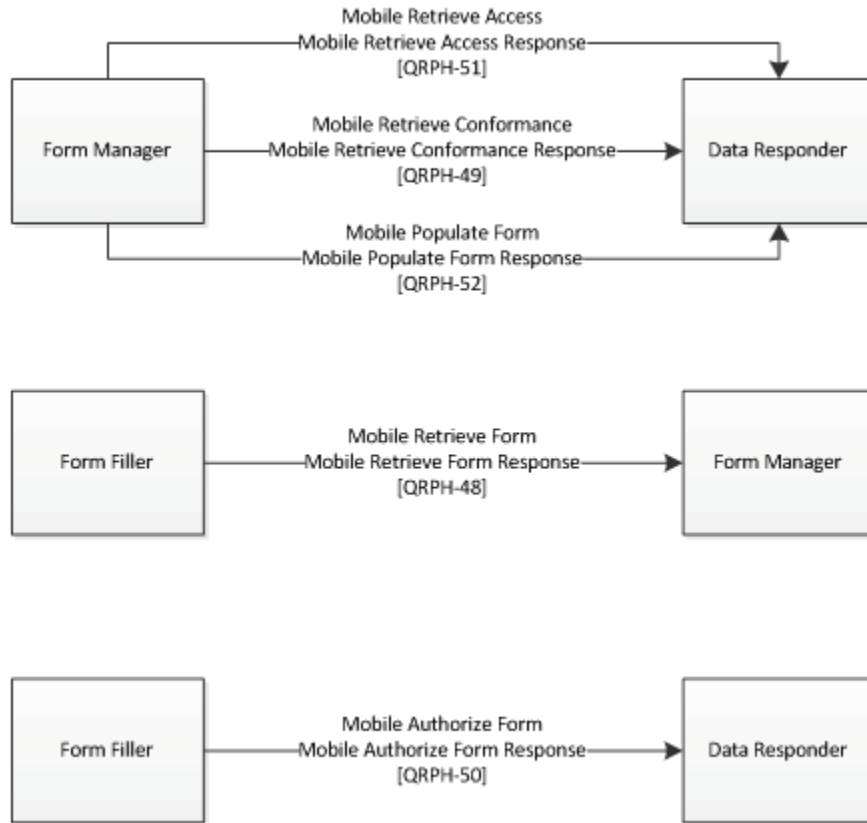

Figure X.1-1: mRFD Actor Diagram

285 Table X.1-1 lists the transactions for each actor directly involved in the mRFD Profile. To claim compliance with this profile, an actor shall support all required transactions (labeled “R”) and may support the optional transactions (labeled “O”).

Table X.1-1: mRFD Profile - Actors and Transactions

Actors	Transactions	Optionality	Reference
Data Responder	Mobile Authorize Form (Response) [QRPH-50]	O	QRPH TF-2: 3.50.4.2
	Mobile Populate Form (Response) [QRPH-52]	R	QRPH TF-2: 3.52.4.2
	Mobile Retrieve Access Token (Response) [QRPH-51]	O	QRPH TF-2: 3.51.4.2
	Mobile Retrieve Capability (Response)[QRPH-49]	O	QRPH TF-2: 3.49.4.2
Form Filler	Mobile Authorize Form (Request) [QRPH-50]	R	QRPH TF-2: 3.50.4.1

Actors	Transactions	Optionality	Reference
	Mobile Retrieve Form (Request)[QRPH-48]	R	QRPH TF-2: 3.48.4.1
Form Manager	Mobile Populate Form (Request) [QRPH-52]	R	QRPH TF-2: 3.52.4.1
	Mobile Retrieve Access Token (Request) [QRPH-51]	R	QRPH TF-2: 3.51.4.1
	Mobile Retrieve Form (Response) [QRPH-48]	R	QRPH TF-2: 3.48.4.2
	Mobile Retrieve Capability (Request)[QRPH-49]	R	QRPH TF-2: 3.49.4.1

290 Table X.1-2 lists the content module(s) defined in the mRFD Profile. To claim support with this profile, an actor shall support all required content modules (labeled “R”) and may support optional content modules (labeled “O”).

Table X.1-2: mRFD Profile - Actors and Content Modules

Actors	Content Modules	Optionality	Reference
Form Filler	-	O	QRPH TF-3
Form Manager	-	O	QRPH TF-3
Data Responder	-	O	QRPH TF-3

X.1.1 Actor Descriptions and Actor Profile Requirements

295 Normative requirements are typically documented in Volume 2 (Transactions) and Volume 3 (Content Modules). Some Integration Profiles, however, contain requirements which link transactions, data, and/or behavior. Those Profile requirements are documented in this section as normative requirements (“SHALL”).

X.1.1.1 Form Filler

The role of the Form Filler in this profile is the one defined in the RFD Profile in ITI TF-1:17.

300 X.1.1.2 Form Manager

The role of the Form Manager in this profile is the one defined in the RFD Profile in ITI TF-1:17.

X.1.1.3 Data Responder

305 The Data Responder is responsible for receiving queries supplied by a Form Manager and returning matching available resources.

X.2 mRFD Actor Options

Options that may be selected for each actor in this profile, if any, are listed in the Table X.2-1. Dependencies between options when applicable are specified in notes.

310 A given Form Filler will have an Expected Data Responder to use with populating form data. The Expected Data Responder must support a full authentication workflow including Mobile Retrieve Capability Request and Mobile Retrieve Access Token Request. The Expected Data Responder must also support Mobile Authorize form.

Standalone Data Responder systems may use other authentication methods to verify their identity. And they do not need to support Mobile Authorize Form.

315 **Table X.2-1: mRFD - Actors and Options**

Actor	Option Name	Reference
Form Filler	-	-
Form Manager	-	-
Data Responder	Expected Data Responder (X.2.1)	QRPH TF-2: 3.49.4.2 QRPH TF-2: 3.50.4.2 QRPH TF-2: 3.51.4.2

X.2.1 Expected Data Responder

A Form Filler, upon initiating a Mobile Retrieve Form Request, will know of at least one Data Responder to use for form querypopulation. That Data Responder is known as the Expected Data Responder.

320 Often, the Expected Data Responder will be maintained by the same entity as is playing the Form Filler. For example, an EMR may initiate the Mobile Retrieve Form Request and indicate the EMR Resource Server as the Expected Data Responder.

A Data Responder implementing the Expected Data Responder Option SHALL meet the following requirements:

- 325
- The Expected Data Responder SHALL implement the Mobile Retrieve Capability Response.
 - The Expected Data Responder SHALL implement the Mobile Authorize Form Response.
 - The Expected Data Responder SHALL implement the Mobile Retrieve Access Token Response.

330 **X.3 mRFD Required Actor Groupings**

There are no required actor groupings in the mRFD Profile.

X.4 mRFD Overview

335 The Mobile Retrieve Form for Data Capture Profile (mRFD) provides a method for gathering data within a user’s current application to meet the requirements of an external system. mRFD supports the retrieval of a form from a form source, the display and completion of the form, and the return of instance data from the display application to a receiving application.

The mRFD Profile supports RESTful versions of the transactions found in the basic RFD Profile, including Mobile Retrieve Form and Mobile Submit Form.

X.4.1 Concepts

340 **X.4.1.1 Structural Differences Between Profiles**

It is important to understand the structural differences between the RFD, SDC and mRFD Profiles. RFD and SDC follow the same transactional structure but have different expectations of the actors. Figure X.4.1.1-1 shows those shared transactions. mRFD has a different transactional structure. Figure X.4.1.1-2 shows those transactions.

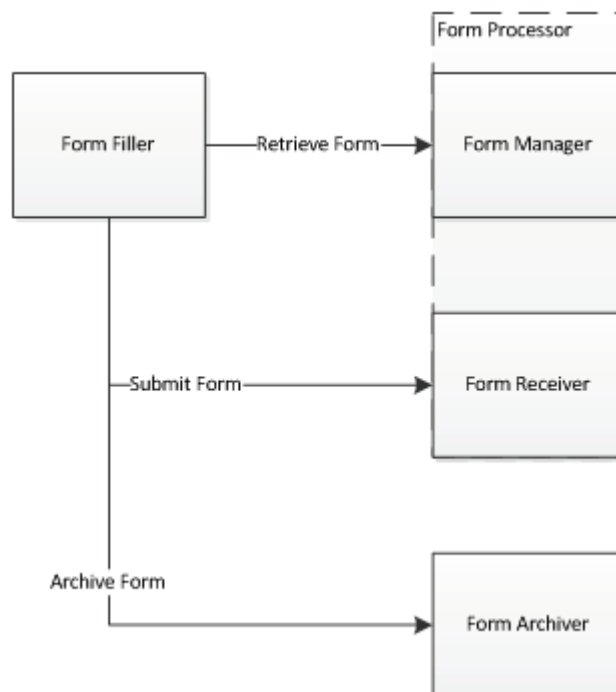

345

Figure X.4.1.1-1: Transactional structure of RFD and SDC

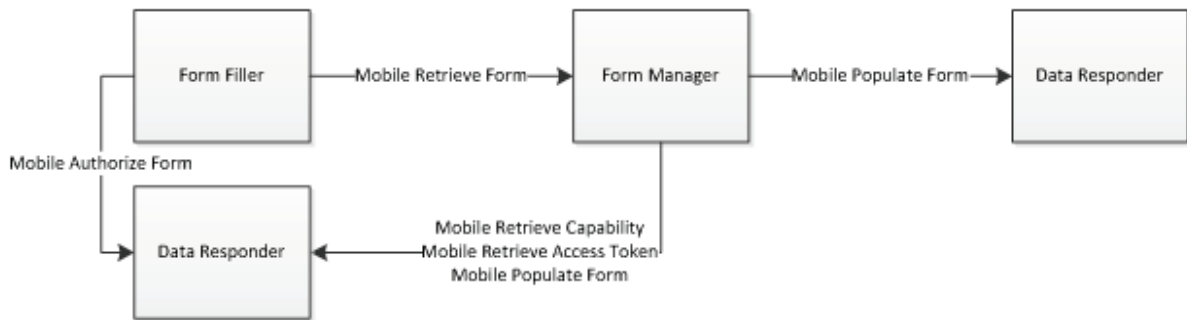

Figure X.4.1.1-2: Transactional structure of mRFD

350 The Retrieve Form and Mobile Retrieve Form transactions both serve the same purpose. They both serve as a request from the Form Filler system to get a form. When the form is received back by the Form Filler, an end user in that system is able to complete any missing form information.

How information is pulled into the form before the Form Filler user gets access to it is described in X.4.1.2. What additional actions are taken by the actors is discussed in Section X.4.1.3.

355 **X.4.1.2 Prepopulation, Autopopulation and Querypopulation**

360 “Population” in this context refers to the action of automatically filling in form fields. It is a method to reduce end user burden by having form fields already completed with known data before end user intervention. The three different approaches (pre-, auto-, and query-) are used in different situations and place different responsibilities on the actors and transactions. The outcome of all three situations will look similar to the end user in the Form Filler system, who simply sees a form that is already partially complete.

X.4.1.2.1 Prepopulation

Prepopulation is predominantly used in RFD when the intent is to have the Form Manager present a form URI to the Form Filler.

365 This exchange can typically be characterized by –

- Transmission of clinical data in the form of a CDA document from the Form Filler to the Form Manager.
- Placing the responsibility for parsing the clinical content on the Form Manager.
- Placing the responsibility of display of a URI containing a form on the Form Filler.
- 370 • Submission of a completed form that includes clinical data to a Form Receiver. Note that a Form Receiver is an actor defined in the RFD Profile that receives the data after it has been submitted by the Form Filler.

X.4.1.2.2 Autopopulation

375 Autopopulation is predominantly used in SDC when the intent is to have the Form Manager return structured XML to the Form Filler.

This exchange can typically be characterized by –

- Transmission of structured form content from the Form Manager to the Form Filler.
- Placing the responsibility for populating clinical content into the form on the Form Filler.
- Placing the responsibility for rendering an XML form on the Form Filler.
- 380 • Submission of a completed form that includes clinical data to a Form Receiver.

X.4.1.2.3 Querypopulation

Querypopulation is used in mRFD.

This exchange can typically be characterized by –

- 385 • Transmission of credentials and endpoint information between the Form Filler and the Form Manager.
- Placing the responsibility for gathering clinical data and populating the form on the Form Manager.
- Placing the responsibility of display of a URI containing a form on the Form Filler.
- Submission of a completed form that includes clinical data to a receiving entity.

X.4.1.2.4 Which Approach to Use

Which approach to use depends on the needs of the individual use case.

- Prepopulation
 - Good fit for Form Fillers that can already create CDA documents.
 - 395 • Good fit if there is a strong trust relationship between the Form Filler and Form Manager, where there are no concerns that the Form Manager may receive broad and irrelevant data sets within the CDA document.
 - Burden placed on the Form Manager to perform population of the form.
 - Limited by which CDA documents the Form Filler can create and what data lives within those CDA documents.
- 400 • Autopopulation
 - Good fit for systems where no data should be sent outside of the Form Filler except for that which is required by the form.

- Good fit for Form Fillers that need a strong, internal record of what form data ended up being autopopulated and what form data was manually populated or modified.
- 405 • Burden placed on the Form Filler, which needs to interpret and parse structured form data.
- Limited by intelligence of the Form Filler. Every time a new field is needed by a form, there is no guarantee that the Form Filler understands that element.
- Querypopulation
- 410 • Good fit for systems requiring lightweight transactions.
- Good fit for environments where clinical data transactions need to be precise to the data elements involved.
- Good fit for environments with multiple sources of data that can serve the Data Responder role.
- 415 • Good fit for environments where each actor needs a strong, internal audit trail of what data was transferred for form population.
- Burden placed on the Form Manager to maintain relationships with relevant Data Responder systems.
- Limited by which resources are supported by the Data Responders.

420 **X.4.1.2.5 Side by Side Workflow Comparison**

Below is a side by side workflow comparison. The columns represent different profile options. The three column wide rows represent shared steps between each option.

Table X.4.1.2.5-1: RFD, SDC and mRFD Workflow Comparison

Prepopulation via RFD or SDC URI	Autopopulation via SDC XML	Querypopulation via mRFD
End user determines that they need to complete a form.		
<ul style="list-style-type: none"> • Form Filler builds a relevant CDA document for inclusion as prepopulation data. • Form Filler initiates Retrieve Form Request. 	<ul style="list-style-type: none"> • Form Filler initiates Retrieve Form Request. 	<ul style="list-style-type: none"> • Form Filler initiates Mobile Retrieve Form Request. • Authorization steps occur including Mobile Retrieve Capability, Mobile Authorize Form and Mobile Retrieve Access Token.

Prepopulation via RFD or SDC URI	Autopopulation via SDC XML	Querypopulation via mRFD
Form Manager/Processor receives the request for a form.		
<ul style="list-style-type: none"> Form Manager/Processor parses the information from the CDA document to complete the form. Form Manager/Processor generates a URI for completion of remaining form data. 	<ul style="list-style-type: none"> Form Manager/Processor generates the XML package representing the codified form structure. 	<ul style="list-style-type: none"> Form Manager initiates Mobile Populate Form Requests against relevant Data Responder systems. Form Manager uses the content of those messages to populate the form. Form Manager generates a URI for completion of remaining form data.
Form Manager(/Processor) sends the form back to the Form Filler.		
<ul style="list-style-type: none"> Form Filler launches the form for an end user to complete. 	<ul style="list-style-type: none"> Form Filler parses the structured XML from the form to determine which fields can be pulled from known data sources. Form Filler renders the received form definition, including the population information. 	<ul style="list-style-type: none"> Form Filler launches the form for an end user to complete.
End user now has the form, already partially populated.		

X.4.1.3 Data Submission

425 Data submission is a topic profiled by RFD URI and SDC, but it is not profiled by mRFD.

In RFD, when the URI is launched by the Form Filler, control of the form content and form actions has already been determined by the Form Manager/Processor. Any actions that occur within the form will appear from the IP address of the Form Filler. Typically, the form will have a button that submits the completed data. That completed form data is sent to a Form Receiver/Processor as part of a Submit Form [ITI-35] transaction.

430

In SDC, the form is hosted locally in the Form Filler. Control of the form content and form actions has already been determined by the Form Manager/Processor. When submission occurs, the Form Filler will package the form data into an SDC Submit Form Response and send it along to the Form Receiver/Processor.

435

In mRFD, it is expected that the same sorts of actions are likely to occur. The form information, once completed in the URL by the Form Filler, needs to be passed back to whatever system needs the information. As there are plenty of options available for data submission from a web

page, that submission is not profiled by mRFD and can be accomplished however it is designed by the Form Manager.

440 **X.4.1.4 Form Selection**

Determination of which form an end user in a Form Filler wants to complete varies between these methods.

445 In RFD and SDC, there is a static URI that is used by the Form Filler to contact the Form Manager and request a form. Which form is being requested is sent by the Form Filler as part of the Retrieve Form Request. For each new form created by the Form Manager, the Form Filler will need to be able to put the new form ID into the outgoing Retrieve Form Request message in order to request the new form.

450 In mRFD, each form is represented by its own URI. There is no separate form ID concept. For each new form created by the Form Manager, the Form Filler will need to be able to send a Mobile Retrieve Form Request to a new URI in order to request the new form.

X.4.1.5 Additional Data Gathering

455 For RFD URI using prepopulation, no additional transactions are expected after the form has been submitted. It may be possible for a Form Receiver/Processor to initiate data gathering steps using identifying information in the form, but for most situations, codified links to the initial prepopulation data do not persist. In order for more data to be sent, the process needs to begin again from the Form Filler side.

460 For SDC using autopopulation, no additional transactions are expected after the form has been submitted. Because the Form Receiver/Processor only has access to the form information, codified links to the initial autopopulation data do not persist. In order for more data to be sent, the process needs to begin again from the Form Filler side.

465 For mRFD using querypopulation, additional Mobile Populate Form transactions can occur after the form has been submitted. The access token in the possession of the Form Manager allows that system to gather additional data by initiating additional queries against the Data Responder. Additional Mobile Populate Form transactions can occur against other Data Responders known to the Form Manager. Additional exchanges may be used to check back when more information has been added to a clinical chart, to see whether a condition has been appropriately treated a week later, or to update historic form submissions.

470 The structure of mRFD opens potentially important flexibility options that should be treated with care, as the authority of the Form Manager/Processor may be different in scope than the authority of the Form Filler. If uncertainty exists in a given implementation, a Risk Assessment would be advisable to mitigate those risks.

475 Note that where an RFD exchange may send a CDA document as prepopulation content, a Form Manager in the mRFD Profile that requires a CDA document for form population will request such a document through a Mobile Populate Form transaction. In mRFD, the Form Filler will not interact with the CDA document.

X.4.2 Use Cases

X.4.2.1 Use Case #1: Research Enrollment

This use case encompasses a researcher within an EMR that wishes to transfer some clinical data about their subject to the RMS for use in an open research study.

480 **X.4.2.1.1 Research Enrollment Use Case Description**

A clinical user in North Carolina is using their tablet for mobile EMR access while interacting with patients. While doing so, the clinician identifies that the patient fits both the requirements and interest level to be enrolled in a specific study within the RMS.

485 **Note: Study criteria may be managed with other QRPH profiles like Research Matching (RM).**

The clinician uses their tablet to request a form from the RMS. This form returns and is displayed to the clinician partially populated with data from the EMR.

490 It also includes prompts for additional fields required by this particular study that were not available in the EMR population data or via the query to the EMR. This information may be data that is not captured in the EMR but is necessary for the study, or it may be data that is simply not included in the query content. The clinician completes the form on their tablet to flesh out the initial registration of the patient in the study.

Note: Enrollment may be managed with other QRPH profiles like Clinical Research Process Content (CRPC).

495 **X.4.2.1.2 Research Enrollment Process Flow**

In this use case, the EMR is serving as the role of the Form Filler and Data Responder. The RMS is hosting the form as the Form Manager.

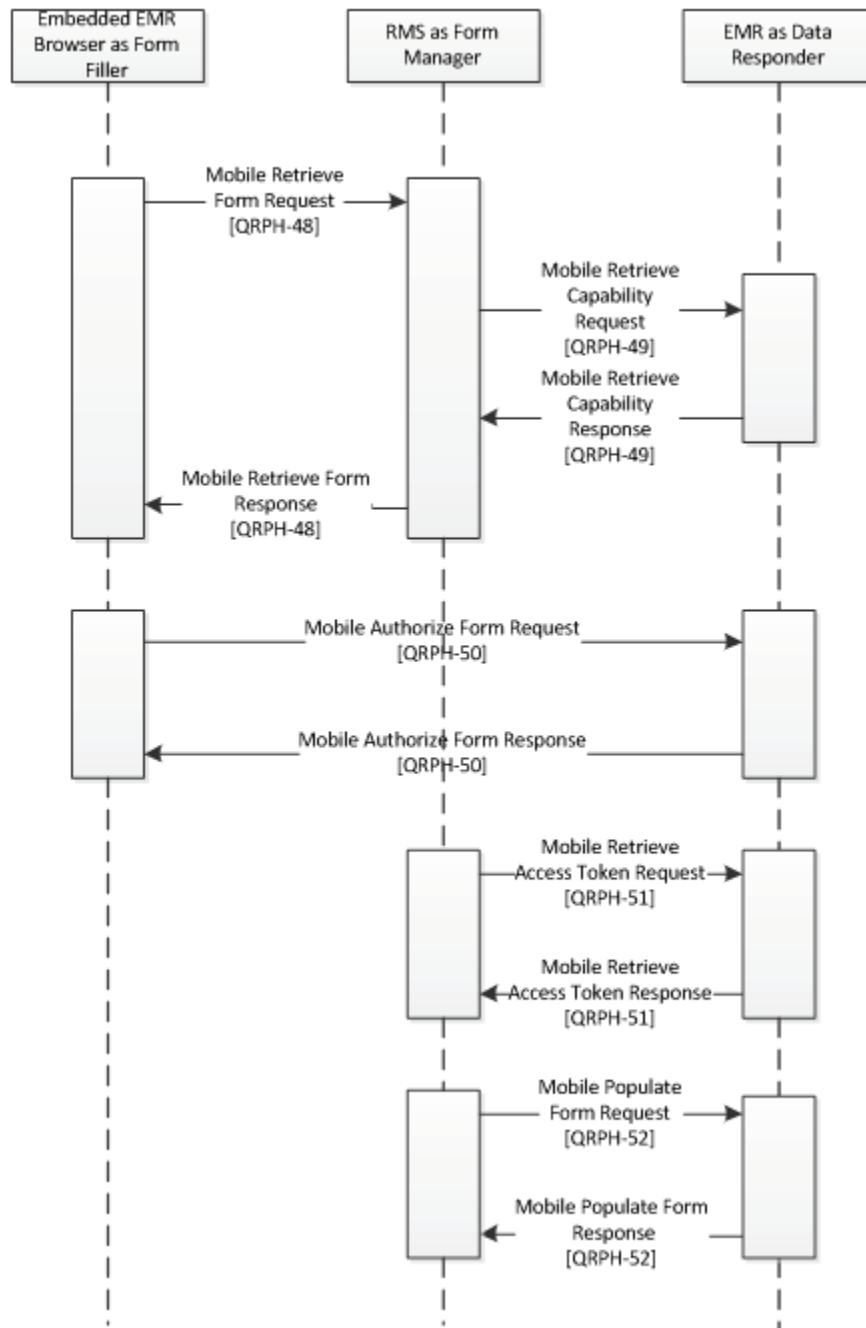

500

Figure X.4.2.1.2-1: Use Case 1 - Research Enrollment Process Flow

Pre-conditions:

This module would be used when the researcher in the EMR identifies that clinical patient data should be transmitted to the RMS for the sake of a research study on that subject.

505

Main Flow:

1. Pre-Conditions are met. Subject is enrolled in study and clinical data exists that needs to be transferred to fill out the basic study parameters.
- 510 2. Researcher initiates exchange in the browser embedded in the EMR system. Authorization steps occur.
 - a. The embedded Browser initiates a Mobile Retrieve Form Request.
 - b. The RMS initiates a Mobile Retrieve Capability Request and receives back the Mobile Retrieve Capability Response.
 - 515 c. The RMS redirects the Browser to the EMR database Data responder using a Mobile Retrieve Form Response.
 - d. The Browser initiates a Mobile Authorize Form Request against the EMR database Data Responder.
 - e. The EMR database Data Responder responds with a Mobile Authorize Form Response.
- 520 3. The Embedded EMR Browser redirects to the URL provided in the Mobile Authorize Form Response.
4. The RMS initiates data gathering steps.
 - a. The RMS initiates a Mobile Retrieve Access Token Request against the EMR database Data Responder.
 - 525 b. The EMR database Data Responder grants access via a Mobile Retrieve Access Token Response, which includes an access token.
 - c. The RMS sends one or more Mobile Populate Form Requests to the EMR database Data Responder.
 - d. The EMR responds to each request with a Mobile Populate Form Response.
- 530 5. The RMS uses the retrieved data to populate the URL that was provided to the Embedded EMR Browser.
6. User in the embedded EMR completes form, filling in any missing information. User in EMR submits form via the URL.

535 Post-conditions:

After the flow is completed, the RMS has the necessary information for the initial data elements in the study. It has resource identification information in case additional information is needed after the fact or in case it needs to query for updates later.

X.4.2.2 Use Case #2: Public Health Enrollment

540 This use case encompasses a provider within an EMR that wishes to transfer some clinical data about their patient to a Public Health information portal in line with jurisdictional requirements.

X.4.2.2.1 Public Health Enrollment Use Case Description

545 A public health provider in Vietnam is in a remote location where they see patients. They are using a web browser on their phone to access a view of EMR data. While doing so, they recognize that the patient they are working with has measles. This necessitates a notification to Public Health.

The provider uses their phone to request a form from Public Health using mRFD. This form returns and is displayed to the provider partially populated with:

- Data populated from the EMR
- 550 • Data populated from the Vaccination Registry in Vietnam with respect to this patient's measles vaccination history.

555 It also includes prompts for additional fields required by this particular case report form that were not available in the EMR population data or via the query to the EMR. This information may be data that is not captured in the EMR but is necessary for the report, or it may be data that is simply not included in the query content. The provider completes the form on their phone to flesh out the initial registration of the Public Health incident.

X.4.2.2.2 Public Health Enrollment Process Flow

560 In this use case, the EMR is serving as the role of the Form Filler. The Public Health Information portal is hosting the form as the Form Manager. The EMR resource server is a Data Responder implementing the Expected Data Responder Option. The Vaccination Registry is an additional Data Responder.

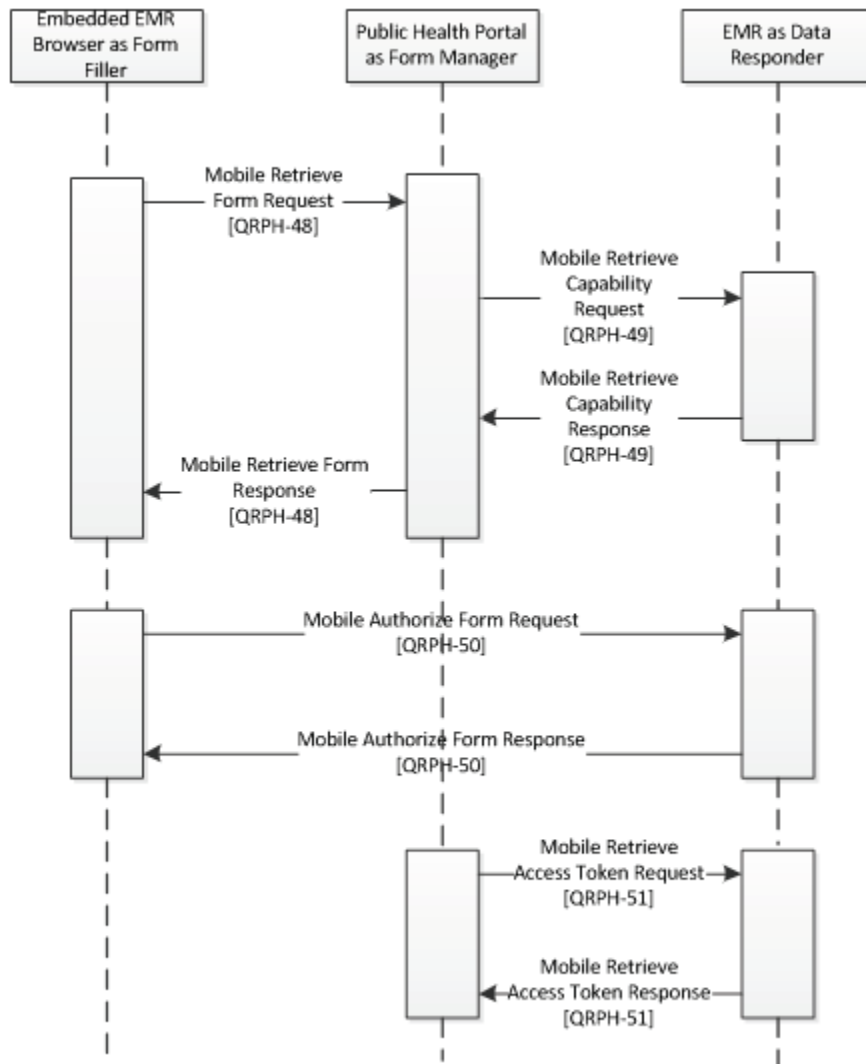
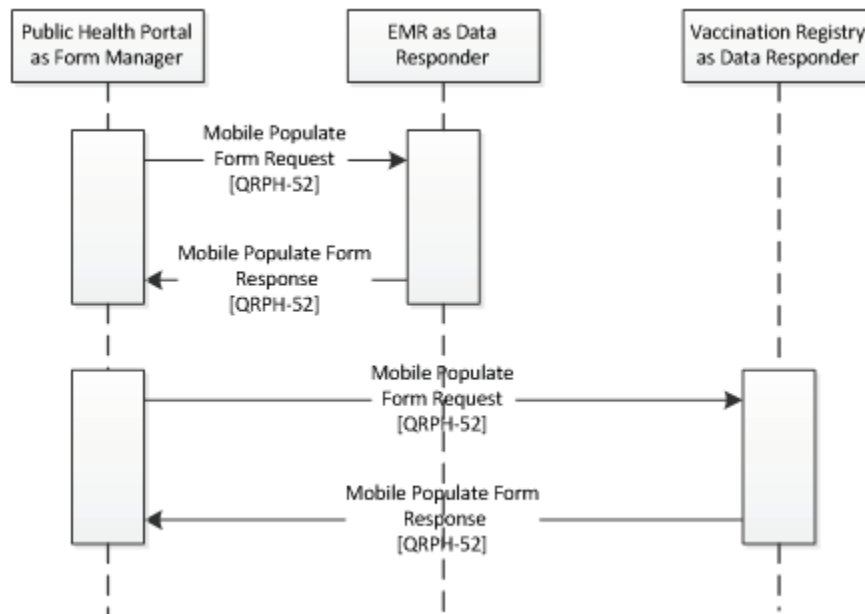

Figure X.4.2.2.2-1: Use Case 2 - Public Health Enrollment Authorization Process Flow



565

Figure X.4.2.2.2-2: Use Case 2 - Public Health Enrollment Form Population Process Flow

Pre-conditions:

This module would be used when the provider in the EMR identifies that patient data should be transmitted to Public Health in line with jurisdictional requirements.

570

Main Flow:

1. Pre-Conditions are met. Patient has been identified as needing to have information submitted to Public Health and that information has been documented in the EMR.
2. Provider initiates exchange in the browser embedded in the EMR system. Authorization steps occur.
 - a. The embedded Browser initiates a Mobile Retrieve Form Request.
 - b. The Public Health Portal initiates a Mobile Retrieve Capability Request and receives back the Mobile Retrieve Capability Response.
 - c. The Public Health Portal redirects the Browser to the EMR Database Data Responder with a Mobile Retrieve Form Response.
 - d. The Browser initiates a Mobile Authorize Form Request against the EMR database Data Responder.
 - e. The EMR database Data Responder responds with a Mobile Authorize Form Response.

575

580

- 585 f. The Public Health Portal initiates a Mobile Retrieve Access Token Request against the EMR database Data Responder.
- g. The EMR database Data Responder grants access via a Mobile Retrieve Access Token Response, which includes an access token.
- 590 3. The embedded EMR Browser redirects to the URL provided in the Mobile Authorize Form Response.
4. Authorization steps between the Form Manager and the Vaccination Registry Data Responder occur.
- a. These authorization steps are out of the scope of the mRFD Profile, but may be accomplished by existing IHE profiles such as the IUA (Internet User Authentication) profile. Under such circumstances, an external token authority may be used that is trusted by both parties.
- 595 5. The Public Health Portal initiates data gathering steps with the EMR.
- a. The Public Health Portal sends one or more Mobile Populate Form Requests to the EMR database Data Responder.
- 600 b. The EMR responds to each request with a Mobile Populate Form Response.
6. The Public Health Portal initiates data gathering steps with the Vaccination Registry.
- a. The Public Health Portal sends one or more Mobile Populate Form Requests to the Vaccination Registry Data Responder.
- b. The Vaccination Registry responds to each request with a Mobile Populate Form Response.
- 605 7. The Public Health Portal uses the retrieved data to populate the URL that was provided to the Embedded EMR Browser.
8. User in the embedded EMR completes form, filling in any missing information. User in EMR submits form via the URL.

610

Post-conditions:

After the flow is completed, the Public Health Portal has the necessary information for the initial data elements collected in this incident. It has resource identification information in case additional information is needed after the fact or in case it needs to query for updates later.

615 **X.5 mRFD Security Considerations**

There are many security and privacy concerns with mobile devices, including lack of physical control. Many common information technology uses of HTTP, including REST, are accessing far less sensitive information than health documents. These factors present an especially difficult challenge for the security model. It is recommended that application developers perform a Risk

620 Assessment in the design of the applications, and that Organization responsible for the operational environment using mRFD perform Risk Assessments in the design and deployment of the operational environment. See FHIR STU3 Security:

- <http://hl7.org/fhir/STU3/security.html>

625 A resource server should not return any patient information unless proper authentication and communications security have been proven.

630 There are many reasonable methods of securing interoperability transactions. These security models can be layered in without modifying the characteristics of the mRFD Profile transactions. The use of TLS is encouraged, specifically the use of the ATNA Profile. User authentication on mobile devices is encouraged using Internet User Authorization (IUA) Profile. The network communication security and user authentication are layered in at the HTTP transport layer and do not modify the interoperability characteristics defined in the mRFD Profile.

The Security Audit logging (e.g., ATNA) is recommended. Support for ATNA-based audit logging on the mobile health device may be beyond the ability of this constrained environment.

635 For example, the client (Document Source or Document Consumer) need only support http interactions using JSON encoding, while ATNA Audit Message transaction requires SYSLOG protocol and XML encoding. However, when grouped with XDS actors, the whole system must comply with the ATNA requirement mandated in XDS. For this reason, the use of ATNA Audit Logging is not mandated. This would mean that the Organization responsible for the operational environment must choose how to mitigate the risk of relying only on the service side audit logging.

640 The [QRPH-51] and [QRPH-52] transactions may include patient identifying information. This pattern does present a risk when using typical web server audit logging of URL requests, and browser history. In both of these cases the URL with the patient identity is clearly visible. These risks should be mitigated in system or operational design. See ITI TF-2x: Appendix Z.6 for details.

645 Additional implementation materials and informative documentation may be found with the Argonauts project (<http://docs.smarthealthit.org/authorization/>).

X.5.1 Consistent Time (CT)

650 In order to address identified security risks, all actors in mRFD SHOULD be grouped with Consistent Time (CT) Profile - Time Client. This grouping will assure that all systems have a consistent time clock to assure a consistent timestamp for audit logging and form accuracy.

X.5.2 Audit Trail and Node Authentication (ATNA)

655 Some mRFD transactions include clinical content related to the information subject. In those cases, it is anticipated that transfers of Personal Health Information (PHI) will be protected. The IHE ITI Audit Trail and Node Authentication (ATNA) Profile SHOULD be implemented by the Form Manager and Data Responder Actors to protect node-to-node communication and to

660 produce an audit trail of the PHI related actions when they exchange messages, though other private security mechanisms MAY be used to secure content within enterprise managed systems. The Form Filler MAY implement ATNA, or other methods may be utilized to ensure the security of the user connection.

X.5.3 User Authorization

For security purposes, when sending information specifically to vital records Electronic Registration Systems, systems will also need to know the identity of the user and the location to identify the data source.

665 The OpenID Connect identity layer SHOULD be utilized to support this implementation. (<http://openid.net/connect/>). The OpenID Connect identity layer is compatible with the Internet User Authentication (IUA) Profile.

X.5.4 Consent

670 In some jurisdictions, consent may be needed to provide this information to public health. For these cases, the IHE ITI BPPC or the IHE ITI APPC Integration Profile SHOULD be used to enable this consent management.

X.5.5 Additional RESTful Query Considerations

A major difference between RFD and mRFD is the flexibility for the Data Responder to be a different system that is outside of the Form Filler and Manager relationship.

675 In the RFD Profile, the Form Filler needs to document and complete patient information in order for form prepopulation to occur. In the case of mRFD, the onus for searching for querypopulation data falls upon the Form Manager as they initiate Mobile Populate Form Requests. This may mean that populated data presented to the end user in the Form Filler system includes information that was not previously available to the end user in the Form Filler system.

680 This opens potentially important flexibility options that should be treated with care, as the authority of the Form Manager may be different in scope than the authority of the Form Filler. If uncertainty exists in a given implementation, a Risk Assessment would be advisable to mitigate those risks.

X.5.6 Related Document Sharing

685 If content stored in one of the mRFD actor systems needs to be sent via documents – either embedded within a FHIR resource or uniquely sent after the fact – then pairings of mRFD actors with actors from the Cross Enterprise Document Sharing (XDS) Profile may occur.

X.5.7 Demographic Query

690 mRFD can be used to establish context between systems and the Patient Demographic Query – Mobile (PDQm) Profile may be used to find the correct patient for a more context-specific launch.

X.6 mRFD Cross Profile Considerations

Not applicable.

Volume 2 – Transactions

695 3.48 Mobile Retrieve Form [QRPH-48]

This section corresponds to Transaction [QRPH-48] of the IHE QRPH Technical Framework. Transaction [QRPH-48] is used by the Form Filler and Form Manager Actors.

3.48.1 Scope

This transaction is used to request a form.

700 3.48.2 Actor Roles

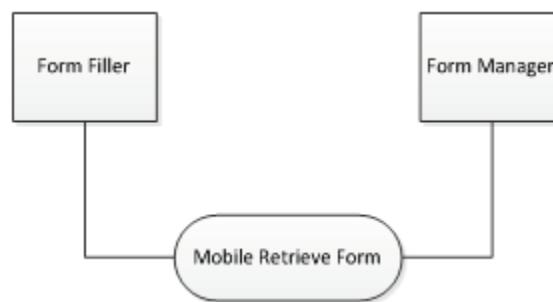

Figure 3.48.2-1: Mobile Retrieve Form Use Case Diagram

Table 3.48.2-1: Mobile Retrieve Form Actor Roles

Actor:	Form Filler
Role:	Represents a system that needs to complete a form. Initiates a request for that form.
Actor:	Form Manager
Role:	Contains forms and takes responsibility for populating those forms with available clinical data.

705

3.48.3 Referenced Standards

HL7 FHIR	HL7 FHIR standard http://hl7.org/fhir
IETF RFC2616	Hypertext Transfer Protocol - HTTP/1.1
IETF RFC7540	Hypertext Transfer Protocol - HTTP/2
IETF RFC3986	Uniform Resource Identifier (URI): Generic Syntax

IETF RFC4627	The application/json Media Type for JavaScript Object Notation (JSON)
IETF RFC6585	Additional HTTP Status Codes
SMART on FHIR	https://hl7.org/fhir/ihe/links/apps Note that this is a living page that serves as a bridge between the HL7 and IHE efforts. It will be updated as SMART on FHIR is balloted through HL7 and as mRFD moves through IHE.

3.48.4 Messages

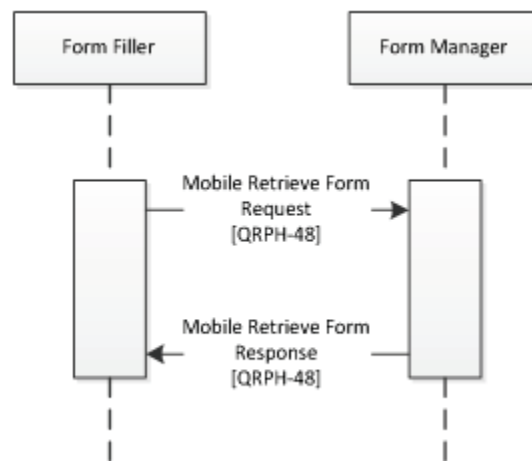

710

Figure 3.48.4-1: Interaction Diagram

3.48.4.1 Mobile Retrieve Form Request

This message uses the HTTP GET method on the target endpoint to retrieve and launch a URL form.

3.48.4.1.1 Trigger Events

715 This method is invoked when a user in the Form Filler browser needs to retrieve a URL for form completion.

3.48.4.1.2 Message Semantics

The Form Filler executes an HTTP GET against the Form Manager’s URL.

720

`https://[Manager URL]?launch=[launch_token]&iss=https://[Responder FHIR Base URL]`

3.48.4.1.2.1 Mobile Retrieve Form Request Parameters

Manager URL [1..1]

725 Represents an https secure URL for the form being launched. This is also known as the application's Launch URL.

launch_token [1..1]

730 Represents a SMART on FHIR launch token. This token will be used to transfer context information between the actors. Acquisition of this token is not profiled here, and may be provided by a direct connection to a Data Responder implementing the Expected Data Responder Option.

Responder FHIR Base URL [1..1]

Represents a FHIR base URL of a Data Responder implementing the Expected Data Responder Option.

735 3.48.4.1.3 Expected Actions

The Form Manager will process the query and provide a redirect URL for the Data Responder in need of authorization.

3.48.4.2 Mobile Retrieve Form Response

740 This message is an HTTP redirect. It indicates to the browser that a different URL needs to be launched.

3.48.4.2.1 Trigger Events

This message is generated when a Form Manager receives a Mobile Retrieve Form Request.

3.48.4.2.2 Message Semantics

745 The Form Manager responds by redirecting the Form Filler. This may occur with a standard HTTP 302 status code to indicate a redirect, or it may involve javascript's window.location.

HTTP/1.1 302 Found

Location: https://[Responder Authorize URL]?

response_type=[response_type]&

750 client_id=[client_id]&

redirect_uri=https://[redirect_uri]

3.48.4.2.2.1 Mobile Retrieve Form Response Parameters

Responder Authorize URL [1..1]

755 The Secure FHIR Authorize URL to the Data Responder's endpoint as received in the Mobile Retrieve Capability Request.

response_type [1..1]

Required - Fixed value: code.

client_id [1..1]

Required - The client's identifier.

760 redirect_uri [1..1]

Required - Must match one of the client's pre-registered redirect URIs.

launch_token [0..1]

Optional - this must match the launch value received from the Form Filler as [launch_token] in Mobile Retrieve Form Response.

765 scope [1..1]

Required - Must describe the access that the app needs, including clinical data scopes like patient/*.read, openid and profile and either

- launch

770 • A value indicating that the app wants to receive already-established launch context details from the Form Filler.

- launch/patient

- A set of launch context requirements which asks the Form Filler to establish context on your behalf.

state [1..1]

775 Required - An opaque value used by the client to maintain state between the request and callback. The authorization server includes this value when redirecting the user-agent back to the client. The parameter SHALL be used for preventing cross-site request forgery or session fixation attacks.

Responder FHIR Base URL [1..1]

780 Required - URL of the Data Responder resource server from which the Form Manager wishes to retrieve FHIR data. This parameter prevents leaking a genuine bearer access_token to a counterfeit resource server. This was received by the Form Manager in the Mobile Retrieve Form Request.

3.48.4.2.3 Expected Actions

785 The Form Filler will process the redirect and use it to initiate a Mobile Authorize Form Request against the Form Manager.

Note that there may be cases where the Data Responder declines to authorize the form. If that is the case, the URL SHALL still be returned to the Form Filler so that an appropriate error can be displayed to the end user.

790 3.48.5 Security Considerations

No Patient Health Information is transferred as part of the Mobile Retrieve Form transaction. HTTPS SHOULD be used as a method to secure the connection between the Form Filler and Form Manager.

3.48.5.1 Security Audit Considerations

795 No Patient Health information is transferred in this transaction, but tracking of authorization requests may be important for security purposes. In that way, the Security audit criteria are similar to those for the Retrieve Form for Data Capture [ITI-34] transaction. The Form Manager SHOULD generate an equivalent to the audit message defined in the Clinical Research Document (CRD) Profile 5.Z3.1.2.

800 3.49 Mobile Retrieve Capability [QRPH-49]

This section corresponds to Transaction [QRPH-49] of the IHE QRPH Technical Framework. Transaction [QRPH-49] is used by the Form Manager and Data Responder Actors.

3.49.1 Scope

This transaction is used to request a statement of behaviors from a Data Responder.

805 3.49.2 Actor Roles

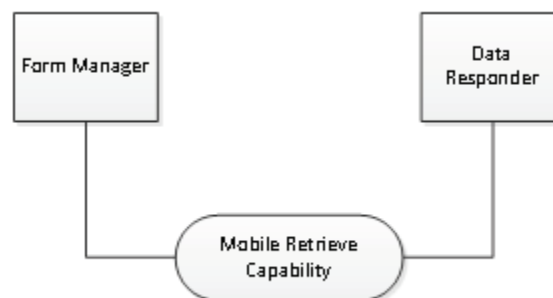

Figure 3.49.2-1: Mobile Retrieve Capability Use Case Diagram

Table 3.49.2-1: Mobile Retrieve Capability Actor Roles

Actor:	Form Manager
Role:	Represents a system that needs to populate a form. To do so, it needs to understand the supported behaviors of the Data Responder.
Actor:	Data Responder
Role:	Contains form data.

810 **3.49.3 Referenced Standards**

HL7 FHIR	HL7 FHIR standard http://hl7.org/fhir
IETF RFC2616	Hypertext Transfer Protocol - HTTP/1.1
IETF RFC7540	Hypertext Transfer Protocol - HTTP/2
IETF RFC3986	Uniform Resource Identifier (URI): Generic Syntax
IETF RFC4627	The application/json Media Type for JavaScript Object Notation (JSON)
IETF RFC6585	Additional HTTP Status Codes
SMART on FHIR	https://hl7.org/fhir/ihe/links/apps Note that this is a living page that serves as a bridge between the HL7 and IHE efforts. It will be updated as SMART on FHIR is balloted through HL7 and as mRFD moves through IHE.

3.49.4 Messages

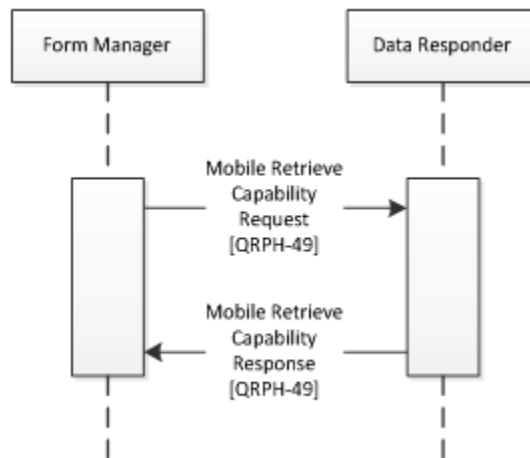

Figure 3.49.4-1: Interaction Diagram

815

3.49.4.1 Mobile Retrieve Capability Request

This message uses the HTTP GET method on the target endpoint to convey desire to retrieve a capability statement.

3.49.4.1.1 Trigger Events

820 This method is invoked when a Form Manager needs to retrieve behavior information for form completion.

3.49.4.1.2 Message Semantics

The Form Manager executes an HTTP GET against the Data Responder's URL.

825 `https://[Responder Base URL]/metadata`

3.49.4.1.2.1 Mobile Retrieve Capability Request Parameters

Responder Base URL

Represents a FHIR base URL.

3.49.4.1.3 Expected Actions

830 The Data Responder will process the query and provide a statement of supported behaviors for the Form Manager to use to retrieve resource endpoints.

The FHIR standard provides encodings for responses as either XML or JSON. The Data Responder SHALL accept both media types `application/json+fhir` and `application/xml+fhir`. The Form Manager SHALL support one and may support both. See ITI TF-2x: Appendix Z.6 for details.

835

3.49.4.2 Mobile Retrieve Capability Response

This message contains a statement of supported behaviors. It may be in XML or JSON.

3.49.4.2.1 Trigger Events

840 This message is generated when a Data Responder receives a Mobile Retrieve Capability Request.

3.49.4.2.2 Message Semantics

The Data Responder responds with a FHIR resource indicating the capacities supported by the Data Responder. See the below informative example.

```
845 {  
  "resourceType": "<Resource Type>",
```

```
    "status" : "<status>",
    "date" : "<date>",
    "kind" : "<Conformance Statement Kind>",
    "fhirVersion" : "<FHIR Version>",
850  "acceptUnknown": "<UnknownContentCode>",
    "format": "<formats accepted>",
    "rest": [{
        "mode": "<RestfulConformanceMode>"
        "security": {
855     "service": [
            {
                "coding": [
                    {
860     "system": "http://hl7.org/fhir/restful-security-
service",
                    "code": "SMART-on-FHIR"
                }
            ],
            "text": "OAuth2 using SMART-on-FHIR profile (see
865 http://docs.smarthealthit.org)"
        }
    ],
    "extension": [{
        "url": "http://fhir-
870 registry.smarthealthit.org/StructureDefinition/oauth-uris",
        "extension": [{
            "url": "token",
            "valueUri": "https://my-server.org/[Responder's
Access Token URL]"
875     }], {
            "url": "authorize",
```

```
        "valueUri": "https://my-server.org/[Responder's
Authorize URL]"
    }}
880   }}
      }}
    }}
  }}
}
```

885 **3.49.4.2.2.1 Mobile Retrieve Capability Response Parameters**

The Data Responder may respond with the following URL parameters as part of the SMART on FHIR extension. The Form Manager SHALL be capable of processing them.

Resource Type [1..1]

890 Required - the type of resource being used to transmit capability. This SHALL be a CapabilityStatement resource.

Responder's Authorize URL [1..1]

Required - valueUri indicating the OAuth2 "authorize" endpoint for this FHIR server. This will be returned to the Form Filler in the Mobile Retrieve Form Response.

Responder's Access Token URL [1..1]

895 Required - valueUri indicating the OAuth2 access "token" endpoint for this FHIR server.

register [0..1]

Optional - valueUri indicating the OAuth2 dynamic registration endpoint for this FHIR server, if supported.

manage [0..1]

900 Optional - valueUri indicating the user-facing authorization management workflow entry point for this FHIR server.

3.49.4.2.3 Expected Actions

The Form Manager will process the statement of behavior and use it to initiate a Mobile Retrieve Access Token Request.

905 The FHIR standard provides encodings for responses as either XML or JSON. The Data Responder SHALL accept both media types application/json+fhir and application/xml+FHIR. The Form Manager SHALL support one and may support both. See ITI TF-2x: Appendix Z.6 for details.

3.49.5 Security Considerations

910 No Patient Health Information is transferred as part of the Mobile Retrieve Capability transaction. HTTPS SHOULD be used as a method to secure the connection between the Form Filler and Form Manager.

3.49.5.1 Security Audit Considerations

915 No Patient Health information is transferred in this transaction, but tracking of authorization requests may be important for security purposes. In that way, the Security audit criteria are similar to those for the Retrieve Form for Data Capture [ITI-34] transaction. The Form Manager SHOULD generate an equivalent to the audit message defined in the Clinical Research Document (CRD) Profile 5.Z3.1.2. The Data Responder SHOULD generate an equivalent to the audit message defined in the Clinical Research Document (CRD) Profile 5.Z3.1.1.

920 3.50 Mobile Authorize Form [QRPH-50]

This section corresponds to Transaction [QRPH-50] of the IHE QRPH Technical Framework. Transaction [QRPH-50] is used by the Form Manager and Data Responder Actors.

3.50.1 Scope

925 This transaction is used to request authorization for the FHIR resource server from a Data Responder.

3.50.2 Actor Roles

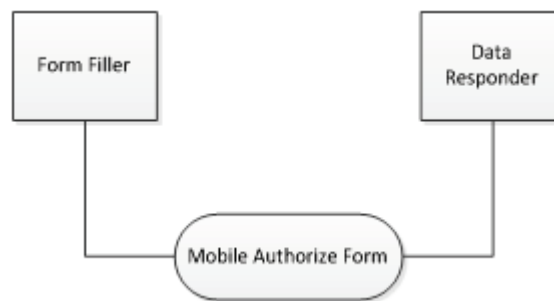

Figure 3.50.2-1: Mobile Authorize Form Use Case Diagram

930

Table 3.50.2-1: Mobile Authorize Form Actor Roles

Actor:	Form Filler
Role:	Represents a system that needs to fill in a form.
Actor:	Data Responder
Role:	Contains form data.

3.50.3 Referenced Standards

HL7 FHIR	HL7 FHIR standard http://hl7.org/fhir
IETF RFC2616	Hypertext Transfer Protocol - HTTP/1.1
IETF RFC7540	Hypertext Transfer Protocol - HTTP/2
IETF RFC3986	Uniform Resource Identifier (URI): Generic Syntax
IETF RFC4627	The application/json Media Type for JavaScript Object Notation (JSON)
IETF RFC6585	Additional HTTP Status Codes
OpenID	http://openid.net/connect/
SMART on FHIR	https://hl7.org/fhir/ihe/links/apps Note that this is a living page that serves as a bridge between the HL7 and IHE efforts. It will be updated as SMART on FHIR is balloted through HL7 and as mRFD moves through IHE.

3.50.4 Messages

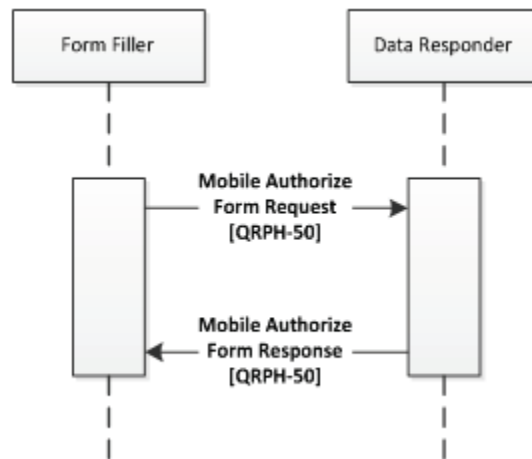

Figure 3.50.4-1: Interaction Diagram

3.50.4.1 Mobile Authorize Form Request

This message uses the HTTP GET method on the target endpoint to retrieve authorization for resource access.

935

940 **3.50.4.1.1 Trigger Events**

This method is invoked when a Form Filler needs to retrieve authorization for data gathering efforts for form completion.

3.50.4.1.2 Message Semantics

The Form Filler executes an HTTP GET against the Data Responder's Authorization URL.

945

```
https://[Responder Base URL]/authorize?  
response_type=[response_type]&  
client_id=[client_id]&  
redirect_uri=https://[redirect_uri]
```

950 **3.50.4.1.2.1 Mobile Authorize Form Request Parameters**

The Form Filler SHALL perform an HTTP GET at the URL provided in the Mobile Retrieve Form Response message.

3.50.4.1.3 Expected Actions

955 The Data Responder will process the query and provide a redirect URL for the Form Filler to launch.

The FHIR standard provides encodings for responses as either XML or JSON. The Data Responder SHALL accept both media types application/json+fhir and application/xml+FHIR. The Form Filler SHALL support one and may support both. See ITI TF-2x: Appendix Z.6 for details.

960 **3.50.4.2 Mobile Authorize Form Response**

This message is an HTTP redirect. It indicates to the browser that a different URL needs to be launched.

3.50.4.2.1 Trigger Events

This message is generated when a Data Responder receives a Mobile Retrieve Form Request.

965 **3.50.4.2.2 Message Semantics**

The Data Responder responds by redirecting the Form Filler. This may occur with a standard HTTP 302 status code to indicate a redirect, or it may involve javascript's window.location.

In addition, a GET parameter on the redirect will be the authorization code that was obtained from the Data Responder.

970

HTTP/1.1 302 Found

Location: [redirect_uri]

3.50.4.2.2.1 Mobile Authorize Form Response Parameters

redirect_uri [1..1]

975 New location is a secure URL to launch for the end user to see the form content. As received by Mobile Authorize Form Request.

authorization_code [1..1]

A GET parameter on the redirect is the authorization code being provided to the Form Manager.

980 state [1..1]

A GET parameter on the redirect that is the same as the state parameter earlier.

3.50.4.2.3 Expected Actions

The Form Filler will process the redirect.

985 The FHIR standard provides encodings for responses as either XML or JSON. The Data Responder SHALL accept both media types application/json+fhir and application/xml+FHIR. The Form Filler SHALL support one and may support both. See ITI TF-2x: Appendix Z.6 for details.

990 Note that there may be cases where the Data Responder declines to authorize the form. If that is the case, the URL SHALL still be returned to the Form Filler so that an appropriate error can be displayed to the end user when the redirect is processed back to the Form Manager.

3.50.5 Security Considerations

No Patient Health Information is transferred as part of the Mobile Authorize Form Response. HTTPS SHOULD be used as a method to secure the connection between the Form Filler and Data Responder.

3.50.5.1 Security Audit Considerations

995 No Patient Health information is transferred in this transaction, but tracking of authorization requests may be important for security purposes. In that way, the Security audit criteria are similar to those for the Retrieve Form for Data Capture [ITI-34] transaction. The Data Responder SHOULD generate an equivalent to the audit message defined in the Clinical Research Document (CRD) Profile 5.Z3.1.1.
1000

3.51 Mobile Retrieve Access Token [QRPH-51]

This section corresponds to Transaction [QRPH-51] of the IHE QRPH Technical Framework. Transaction [QRPH-51] is used by the Form Manager and Data Responder Actors.

3.51.1 Scope

1005 This transaction is used to request access for the FHIR resource server from a Form Manager.

3.51.2 Actor Roles

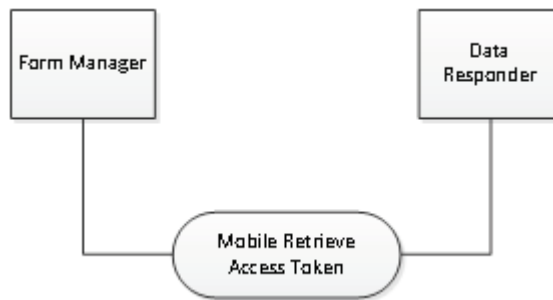

Figure 3.51.2-1: Mobile Retrieve Access Token Use Case Diagram

1010

Table 3.51.2-1: Mobile Retrieve Access Token Actor Roles

Actor:	Form Manager
Role:	Represents a system that needs authorization in order to populate form data.
Actor:	Data Responder
Role:	Contains form data.

3.51.3 Referenced Standards

HL7 FHIR	HL7 FHIR standard http://hl7.org/fhir
IETF RFC2616	Hypertext Transfer Protocol - HTTP/1.1
IETF RFC7540	Hypertext Transfer Protocol - HTTP/2
IETF RFC3986	Uniform Resource Identifier (URI): Generic Syntax
IETF RFC4627	The application/json Media Type for JavaScript Object Notation (JSON)
IETF RFC6585	Additional HTTP Status Codes
SMART on FHIR	https://hl7.org/fhir/ihe/links/apps Note that this is a living page that serves as a bridge between the HL7 and IHE efforts. It will be updated as SMART on FHIR is balloted through HL7 and as mRFD moves through IHE.

3.51.4 Messages

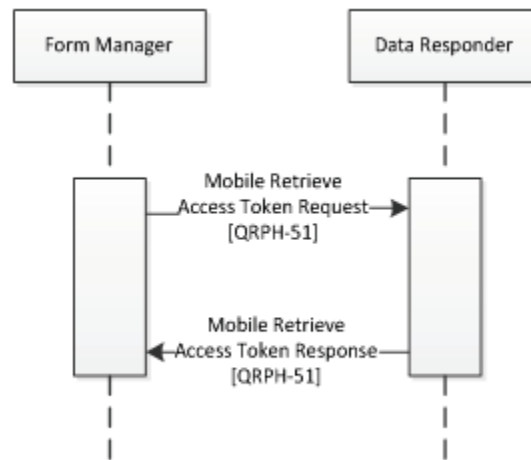

1015

Figure 3.51.4-1: Interaction Diagram

3.51.4.1 Mobile Retrieve Access Token Request

This message uses the HTTP POST method on the target endpoint to convey desire to retrieve access.

1020 3.51.4.1.1 Trigger Events

This method is invoked when a Form Manager needs to retrieve access for data gathering efforts for form completion.

3.51.4.1.2 Message Semantics

1025 The Form Manager executes an HTTP POST against the Data Responder's Access Token URL from the Mobile Retrieve Capability Response.

```
POST /token HTTP/1.1
Host: ehr
Authorization: Basic
1030 [client id : client secret]
Content-Type: application/x-www-form-urlencoded
grant_type=authorization_code&
code=[authorization_code]&
redirect_uri=[redirect]
```

1035

3.51.4.1.2.1 Mobile Retrieve Access Token Request Parameters

The Form Manager MAY send the following parameters, and the Data Responder MAY be capable of processing them.

`client id : client secret [0..1]`

- 1040 Optional - A client ID and client secret may be sent to secure the client connection. This parameter is base64 encoded. Additional information is available here: <http://docs.smarthealthit.org/authorization/>.

`grant_type [1..1]`

Required - Fixed value: `authorization_code`.

- 1045 `authorization_code [1..1]`

Required - Code that the app received from the authorization server.

`redirect_uri [1..1]`

Required - The same `redirect_uri` used in the initial authorization request.

`client_id [0..1]`

- 1050 Optional - this value SHALL be included for public applications, but MAY be included for confidential applications.

3.51.4.1.3 Expected Actions

The Data Responder will process the query and provide a Mobile Retrieve Access Token Response to the Form Manager.

- 1055 The FHIR standard provides encodings for responses as either XML or JSON. The Data Responder SHALL accept both media types `application/json+fhir` and `application/xml+fhir`. The Form Manager SHALL support one and may support both. See ITI TF-2x: Appendix Z.6 for details.

3.51.4.2 Mobile Retrieve Access Token Response

- 1060 This message returns an access token to the HTTP response.

3.51.4.2.1 Trigger Events

This message is generated when a Data Responder receives a Mobile Retrieve Access Token Request.

3.51.4.2.2 Message Semantics

- 1065 The Data Responder responds, granting or denying access.

```
{
  "access_token": "[access_token]",
```

```
1070     "token_type": "Bearer",  
        "expires_in": [expires],  
        "scope": "[scope]"  
    }
```

3.51.4.2.2.1 Mobile Retrieve Access Token Response Parameters

1075 The Data Responder MAY respond with the following parameters, and the Form Manager SHALL be capable of processing them.

access_token [1..1]

Required - The access token issued by the authorization server

token_type [1..1]

Required - Fixed value: "Bearer".

1080 expires_in [0..1]

Optional - Lifetime in seconds of the access_token, after which the token SHALL NOT be accepted by the resource server.

scope [1..1]

1085 Required - Scope of access authorized. Note that this can be different from the scopes requested by the Form Manager.

id_token [0..1]

Optional - Authenticated patient identity and profile.

refresh_token [0..1]

1090 Optional - Token that can be used to obtain a new access token, using the same or a subset of the original authorization grants.

Additional parameters will be returned by the Data Responder depending on integration needs. Those additional parameters may be further constrained by future profiles. Common examples include:

1095 patient [0..1]

Optional - Identifier of a patient for use with Mobile Populate Form.

researchSubject [0..1]

Optional - Identifier of a research subject for use with Mobile Populate Form.

1100 `researchStudy` [0..1]

Optional - Identifier of a research study for use with Mobile Populate Form.

3.51.4.2.3 Expected Actions

1105 The Form Manager has received access to the FHIR resource server and will use the parameters received to initiate Mobile Populate Form Request(s).

The FHIR standard provides encodings for responses as either XML or JSON. The Data Responder SHALL accept both media types `application/json+fhir` and `application/xml+fhir`. The Form Manager SHALL support one and may support both. See ITI TF-2x: Appendix Z.6 for details.

1110 There may be cases where a Mobile Retrieve Access Token Request from the Form Manager to the Data Responder requests one set of resources, but the Mobile Retrieve Access Token Response from the Data Responder to the Form Manager does not allow access to those resources. The Data Responder SHALL respond with the scopes for which it is granting access. The provided scopes may not match those requested by the Form Manager.

1115 3.51.5 Security Considerations

The Mobile Retrieve Access Token Response is a PHI-Export event, as defined in ITI TF-2a: Table 3.20.4.1.1.1-1.

3.51.5.1 Security Audit Considerations

1120 The Security audit criteria are similar to those for the Retrieve Form for Data Capture [ITI-34] transaction as this transaction does communicate clinical data for purposes of form completion. The Form Manager SHOULD generate an equivalent to the audit message defined in the Clinical Research Document (CRD) Profile 5.Z3.1.2. The Data Responder SHOULD generate an equivalent to the audit message defined in the Clinical Research Document (CRD) Profile 5.Z3.1.1.

1125 3.52 Mobile Populate Form [QRPH-52]

This section corresponds to Transaction [QRPH-52] of the IHE QRPH Technical Framework. Transaction [QRPH-52] is used by the Form Manager and Data Responder Actors.

3.52.1 Scope

This transaction is used to request form completion data from a Data Responder.

1130 3.52.2 Actor Roles

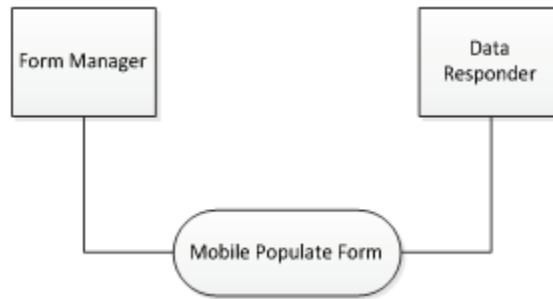

Figure 3.52.2-1: Mobile Populate Form Use Case Diagram

Table 3.52.2-1: Mobile Populate Form Actor Roles

Actor:	Form Manager
Role:	Represents a system that needs access to clinical data to be used to populate a form.
Actor:	Data Responder
Role:	Contains form data.

1135 **3.52.3 Referenced Standards**

HL7 FHIR	HL7 FHIR standard http://hl7.org/fhir
IETF RFC2616	Hypertext Transfer Protocol - HTTP/1.1
IETF RFC7540	Hypertext Transfer Protocol - HTTP/2
IETF RFC3986	Uniform Resource Identifier (URI): Generic Syntax
IETF RFC4627	The application/json Media Type for JavaScript Object Notation (JSON)
IETF RFC6585	Additional HTTP Status Codes
SMART on FHIR	https://hl7.org/fhir/ihe/links/apps Note that this is a living page that serves as a bridge between the HL7 and IHE efforts. It will be updated as SMART on FHIR is balloted through HL7 and as mRFD moves through IHE.

3.52.4 Messages

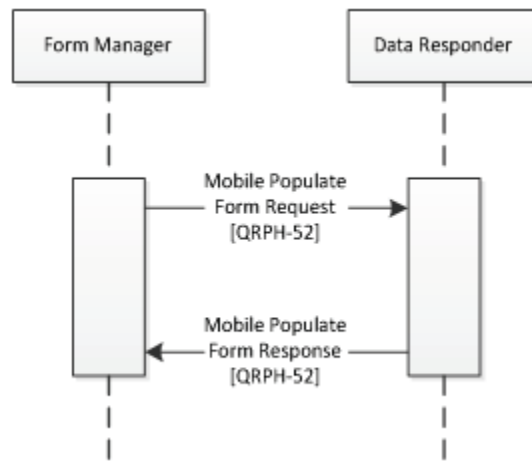

1140

Figure 3.52.4-1: Interaction Diagram

3.52.4.1 Mobile Populate Form Request

This message uses the HTTP POST method on the target endpoint to convey specific desired resources.

3.52.4.1.1 Trigger Events

1145 This method is invoked when a Form Manager needs to retrieve data for populating a form from a Data Responder.

3.52.4.1.2 Message Semantics

1150 The Form Manager executes an HTTP POST against a Data Responder’s resource URL. Note that the `access_token` received in [QRPH-51] will be used if this is the Data Responder as part of the GET.

Part of the HTTP Authorization header will include the access token provided earlier.

`https://[Responder’s FHIR Base URL]/[Resource Requested]`

3.52.4.1.2.1 Mobile Populate Form Request Parameters

1155 The Form Manager MAY send any of the parameters it received during a Mobile Retrieve Access Token Response, or additional query parameters that fit the integration needs.

Responder’s FHIR Base URL [1..1]

The endpoint to use to retrieve FHIR resources

1160 Resources Requested [0..*]

Requested resources are open to a given integration.

Common examples include:

patient [0..*]

1165 Identifier of a patient

researchSubject [0..*]

Identifier of a research subject

researchStudy [0..*]

Identifier of a research study

1170 **3.52.4.1.3 Expected Actions**

The Data Responder will process the query and provide a Mobile Populate Form Response to the Form Manager.

The FHIR standard provides encodings for responses as either XML or JSON. The Data Responder SHALL accept both media types application/json+fhir and application/xml+FHIR.

1175 The Form Manager SHALL support one and may support both. See ITI TF-2x: Appendix Z.6 for details.

3.52.4.2 Mobile Populate Form Response

This message returns a FHIR bundle including the requested resources.

3.52.4.2.1 Trigger Events

1180 This message is generated when a Data Responder receives a Mobile Populate Form Request.

3.52.4.2.2 Message Semantics

```
1185 {
  "resourceType" : "Bundle",
  "type" : "[Bundle Type]",
  "entry" : [{
    "link" : [{ "https://[Responder URL]/Patient/[Unique ID]"
  }],
  "fullUrl" : ""https://[Responder URL]/Patient/[Unique ID]"",
  "resource" : { [Requested Resources] },
```

```
1190     "search" : {
        "mode" : "<Mode code>",
      },
    ],
  }
}
```

1195 **3.52.4.2.2.1 Mobile Populate Form Response Parameters**

The Data Responder SHOULD respond with the requested resources if the Form Manager has access to them. It may not respond with all resources requested if they are not available or if access was not granted to those resources.

Bundle Type [1..1]

1200 The FHIR BundleType of this message.

Responder URL [1..1]

The FHIR server's base URL.

Unique ID [1..1]

The unique ID for that resource.

1205 Requested Resources [1..1]

Requested resources have a variety of structures that include the various resources being requested and their related information.

Mode Code [1..1]

The SearchEntryMode for this message.

1210

Common examples of requested resource information include:

patient [0..*]

Identifier of a patient

researchSubject [0..*]

1215 Identifier of a research subject

researchStudy [0..*]

Identifier of a research study

Other parameters that MAY be returned to indicate error states include

1220 operationOutcome [0..1]

Optional - OperationOutcomes MAY be used to provide additional hints and warnings about the search process.

3.52.4.2.3 Expected Actions

1225 The Form Manager uses the retrieved data to populate the form URL that has been provided to the Form Filler.

The FHIR standard provides encodings for responses as either XML or JSON. The Data Responder SHALL accept both media types application/json+fhir and application/xml+FHIR. The Form Manager SHALL support one and may support both. See ITI TF-2x: Appendix Z.6 for details.

1230 There may be situations where a Mobile Populate Form Request requests access to resources that are not within the scope granted by the Data Responder. In those cases, a FHIR Bundle containing the OperationOutcome element MAY be returned by the Data Responder to indicate that the scope was modified and that some requested data will not be returned. Additional guidance on how to respond with search hints and warnings is available through HL7.

1235

- <http://hl7.org/fhir/search.html#errors>

3.52.5 Security Considerations

The Mobile Populate Form Response is a PHI-Export event, as defined in ITI TF-2a: Table 3.20.4.1.1.1-1.

3.52.5.1 Security Audit Considerations

1240 The Security audit criteria are similar to those for the Retrieve Form for Data Capture [ITI-34] transaction as this transaction does communicate clinical data for purposes of form completion. The Form Manager SHOULD generate an equivalent to the audit message defined in the Clinical Research Document (CRD) Profile Section 5.Z3.1.2. The Data Responder SHOULD generate an equivalent to the audit message defined in the Clinical Research Document (CRD) Profile
1245 Section 5.Z3.1.1.

Appendices

Not Applicable

1250

Volume 3 – Content Modules

5 Namespaces and Vocabularies

Not Applicable

6 Content Modules

1255 Not Applicable

Appendices

Not Applicable

1260

Volume 4 – National Extensions

1265 There are no national extensions for the mRFD Profile.