

Integrating the Healthcare Enterprise



5 **IHE Pathology and Laboratory Medicine (PaLM)
Technical Framework**

10 **Volume 1
(PaLM TF-1)
Profiles**

15

20 **Revision 8.0 - Final Text
June 21, 2017**

25 **Please verify you have the most recent version of this document, which is published [here](#).**

CONTENTS

	1	Introduction	7
30	1.1	Introduction to IHE	7
	1.2	Introduction to IHE Pathology & Laboratory Medicine (PaLM)	7
	1.3	Intended Audience	8
	1.4	Pre-requisites and Reference Material	8
	1.4.1	Actor Descriptions	8
35	1.4.2	Common glossary	8
	1.4.3	Standards Profiling and Documentation Conventions	8
	1.4.4	IHE Integration Statements	9
	1.5	Overview of Technical Framework Volume 1	9
	1.6	Comment Process	9
40	1.7	Copyright Licenses	9
	1.7.1	Copyright of Base Standards	10
	1.8	Trademark	10
	1.9	Disclaimer Regarding Patent Rights	10
	1.10	History of Document Changes	11
45	2	Pathology and Laboratory Medicine Integration Profiles	12
	2.1	Required Actor Groupings and Bindings	13
	2.2	Security Implications	14
	2.3	Integration Profiles Overview	14
	2.4	Product Implementations	14
50	3	Laboratory Testing Workflow (LTW) Profile	15
	3.1	LTW Actors and Transactions	15
	3.1.1	Actor Descriptions and Actor Profile Requirements	16
	3.1.1.1	Actor Order Filler	16
	3.2	LTW Actor Options	17
55	3.2.1	Report Facsimile For Order Group	17
	3.3	LTW Required Actor Groupings	18
	3.4	LTW Overview	19
	3.4.1	Concepts	19
	3.4.2	Use Cases	20
60	3.4.2.1	Use Case #1: Placer Order	20
	3.4.2.1.1	Placer Order Use Case Description	20
	3.4.2.1.2	Placer Order Use Case Process Flow	21
	3.4.2.2	Use Case #2: Filler Order	22
	3.4.2.2.1	Filler Order Use Case Description	22
65	3.4.2.2.2	Filler Order Use Case Process Flow	23
	3.4.2.3	Use Case #3: Patient Update	23
	3.4.2.3.1	Patient Update Use Case Description	23
	3.4.2.3.2	Patient Update Use Case Process Flow	24
	3.5	LTW Security Considerations	25

70	3.6	LTW Cross Profile Considerations.....	25
4		Laboratory Device Automation (LDA) Profile.....	26
	4.1	LDA Actors and Transactions	26
	4.1.1	Actor Descriptions and Actor Profile Requirements.....	27
	4.2	LDA Actor Options.....	28
75	4.2.1	Query mode for SWOS.....	28
	4.2.2	Download mode for SWOS	28
	4.3	LDA Required Actor Groupings.....	28
	4.4	LDA Overview.....	29
	4.4.1	Concepts	29
80	4.4.2	Use Cases.....	29
	4.4.2.1	Use Case #1: SWOS Downloaded	29
	4.4.2.1.1	SWOS Downloaded Use Case Description	29
	4.4.2.1.2	SWOS Downloaded Use Case Process Flow.....	30
	4.4.2.2	Use Case #2: SWOS Queried.....	31
85	4.4.2.2.1	SWOS Queried Use Case Description.....	31
	4.4.2.2.2	SWOS Queried Use Case Process Flow	32
	4.5	LDA Security Considerations	32
	4.6	LDA Cross Profile Considerations	32
5		Laboratory Analytical Workflow (LAW) Profile	33
90	5.1	LAW Actors and Transactions.....	34
	5.1.1	Actor Descriptions and Actor Profile Requirements.....	35
	5.1.1.1	Actor Analyzer	35
	5.1.1.2	Actor Analyzer Manager	35
	5.2	LAW Actor Options.....	36
95	5.2.1	Bi-directional Communication	38
	5.2.2	Query by Isolate.....	38
	5.2.3	Query by Rack	38
	5.2.4	Query by Tray.....	38
	5.2.5	Query All	38
100	5.2.6	Contributing Substances	38
	5.2.7	Dilutions	39
	5.2.8	Patient Demographics	39
	5.2.9	Reflex.....	39
	5.2.10	Rerun	40
105	5.2.11	Analyzer Manager Rerun and Reflex	40
	5.2.12	Analyzer Manager Rerun and Reflex Control.....	40
	5.2.13	AWOS Priority	40
	5.2.14	Specimen Details	40
	5.2.15	Container Details	41
110	5.2.16	Mass Spectrometry	41
	5.2.17	External Result	41
	5.2.18	Related Observations.....	41
	5.2.19	Pooling on Analyzer.....	42

	5.2.20 Pooling Outside of Analyzer	42
115	5.3 LAW Required Actor Groupings.....	42
	5.4 LAW Overview.....	43
	5.4.1 Concepts	43
	5.4.2 Use Cases.....	44
	5.4.2.1 Use Case #1: AWOS Broadcast	44
120	5.4.2.1.1 AWOS Broadcast Use Case Description	44
	5.4.2.1.2 AWOS Broadcast Use Case Process Flow	46
	5.4.2.2 Use Case #2: Query ALL	46
	5.4.2.2.1 Query ALL Use Case Description	46
	5.4.2.2.2 Query ALL Use Case Process Flow	47
125	5.4.2.3 Use Case #3: AWOS Query	47
	5.4.2.3.1 AWOS Query Use Case Description	47
	5.4.2.3.2 AWOS Query Use Case Process Flow	49
	5.4.2.4 Use Case #4: AWOS Created On Analyzer	49
130	5.4.2.4.1 AWOS Created On Analyzer Use Case Description	49
	5.4.2.4.2 AWOS Created On Analyzer Use Case Process Flow	50
	5.4.2.5 Use Case #5: Rerun Decided On Analyzer	50
	5.4.2.5.1 Rerun Decided On Analyzer Use Case Description	51
	5.4.2.5.2 Rerun Decided On Analyzer Use Case Process Flow	52
135	5.4.2.6 Use Case #6: Rerun Requested by Analyzer Manager.....	52
	5.4.2.7 Use Case #7: Reflex Decided on the Analyzer	52
	5.4.2.7.1 Reflex Decided On Analyzer Use Case Description	52
	5.4.2.7.2 Reflex Decided On Analyzer Use Case Process Flow.....	53
	5.4.2.8 Use Case #8: Reflex Requested by Analyzer Manager.....	54
	5.4.2.9 Use Case #9: QC Specimen.....	54
140	5.4.2.10 Use Case #10: Specimen Pooled by Analyzer.....	54
	5.4.2.11 Use Case #11: Specimen Pooled Outside of Analyzer.....	54
	5.4.2.12 Use Case #12: Handling External Results	55
	5.5 LAW Security Considerations	55
	5.6 LAW Cross Profile Considerations	56
145	6 Laboratory Point Of Care Testing (LPOCT) Profile.....	57
	6.1 LPOCT Actors and Transactions.....	57
	6.1.1 Actor Descriptions and Actor Profile Requirements.....	59
	6.2 LPOCT Actor Options	59
	6.2.1 Patient Identity Checking	59
150	6.3 LPOCT Required Actor Groupings	59
	6.4 LPOCT Overview	60
	6.4.1 Concepts	61
	6.4.2 Use Cases.....	61
	6.4.2.1 Use Case #1: Ordered.....	61
155	6.4.2.1.1 Ordered Use Case Description.....	61
	6.4.2.1.2 Ordered Use Case Process Flow	63
	6.4.2.2 Use Case #2: Unordered.....	63

	6.4.2.2.1	Unordered Use Case Description.....	63
	6.4.2.2.2	Unordered Use Case Process Flow	65
160	6.4.2.3	Use Case #3: Intermittent Link.....	65
	6.4.2.3.1	Intermittent Link Use Case Description	65
	6.4.2.3.2	Intermittent Link Use Case Process Flow.....	66
	6.4.2.4	Use Case #4: Manual Entry	66
	6.4.2.4.1	Manual Entry Use Case Description.....	67
165	6.4.2.4.2	Manual Entry Use Case Process Flow	67
	6.4.2.5	Use Case #5: QC	67
	6.4.2.5.1	Use Case Description.....	67
	6.4.2.5.2	Use Case Process Flow	68
	6.5	LPOCT Security Considerations.....	69
170	6.6	LPOCT Cross Profile Considerations.....	69
7		Laboratory Specimen Barcode Labeling (LBL) Profile.....	70
	7.1	LBL Actors and Transactions	70
	7.1.1	Actor Descriptions and Actor Profile Requirements	71
	7.2	LBL Actor Options	71
175	7.2.1	Query for labeling instruction.....	71
	7.2.2	Labels and containers delivered.....	72
	7.3	LBL Required Actor Groupings	72
	7.4	LBL Overview	72
	7.4.1	Concepts	72
180	7.4.2	Use Cases.....	73
	7.4.2.1	Use Case #1: Placer Requesting.....	73
	7.4.2.1.1	Placer Requesting Use Case Description	73
	7.4.2.1.2	Placer Requesting Use Case Process Flow	73
	7.4.2.2	Use Case #2: Placer Queried	74
185	7.4.2.2.1	Placer Queried Use Case Description	74
	7.4.2.2.2	Placer Queried Use Case Process Flow	75
	7.4.2.3	Use Case #3: Filler Requesting	75
	7.4.2.3.1	Filler Requesting Use Case Description	75
	7.4.2.3.2	Filler Requesting Use Case Process Flow	76
190	7.4.2.4	Use Case #4: Filler Queried	76
	7.4.2.4.1	Filler Queried Use Case Description	76
	7.4.2.4.2	Filler Queried Use Case Process Flow.....	77
	7.4.2.5	Use Case #5: Placer Queries Filler	77
	7.4.2.5.1	Placer Queries Filler Use Case Description.....	77
195	7.4.2.5.2	Placer Queries Filler Use Case Process Flow	78
	7.5	LBL Security Considerations.....	78
	7.6	LBL Cross Profile Considerations.....	79
8		Laboratory Code Set Distribution (LCSD) Profile	80
	8.1	LCSD Actors and Transactions	80
200	8.1.1	Actor Descriptions and Actor Profile Requirements	81
	8.2	LCSD Actor Options.....	81

	8.2.1 Batch	81
	8.3 LCS D Required Actor Groupings.....	81
	8.4 LCS D Overview.....	82
205	8.4.1 Concepts	82
	8.4.2 Use Cases.....	82
	8.4.2.1 Use Case #1: Full Code Set.....	82
	8.4.2.1.1 Full Code Set Use Case Description.....	82
	8.4.2.1.2 Full Code Set Use Case Process Flow	82
210	8.5 LCS D Security Considerations.....	82
	8.6 LCS D Cross Profile Considerations	82
	9 Sharing Laboratory Reports (XD-LAB) Profile	83
	9.1 XD-LAB Actors, Transactions, and Content Modules.....	83
	9.1.1 Actor Descriptions and Actor Profile Requirements.....	84
215	9.2 XD-LAB Actor Options.....	84
	9.3 XD-LAB Required Actor Groupings.....	84
	9.4 XD-LAB Overview.....	85
	9.4.1 Concepts	85
	9.4.2 Use Cases.....	85
220	9.4.2.1 Use Case #1: Hospital Laboratory Report Shared at Discharge Time	85
	9.4.2.2 Use Case #2 Private Laboratory Report Shared	85
	9.4.2.3 Use Case #3 Ambulatory Physician Shares a Laboratory Report	85
	9.4.2.4 Use Case #4 Cumulative report built and shared at discharge time	85
	9.4.2.5 Use Case #5 Public Health Laboratory Report.....	86
225	9.5 XD-LAB Security Considerations	88
	9.6 XD-LAB Cross Profile Considerations	88
	Appendix A – Security Environment Considerations.....	89
	Glossary	91
230		

1 Introduction

This document, Volume 1 of the IHE Pathology and Laboratory Medicine (PaLM) Technical Framework, describes the clinical use cases, actors, content module, and transaction requirements for the Pathology and Laboratory Medicine profiles.

235 1.1 Introduction to IHE

Integrating the Healthcare Enterprise (IHE) is an international initiative to promote the use of standards to achieve interoperability among health information technology (HIT) systems and effective use of electronic health records (EHRs). IHE provides a forum for care providers, HIT experts and other stakeholders in several clinical and operational domains to reach consensus on standards-based solutions to critical interoperability issues.

240 The primary output of IHE is system implementation guides, called IHE profiles. IHE publishes each profile through a well-defined process of public review and Trial Implementation and gathers profiles that have reached Final Text status into an IHE Technical Framework, of which this volume is a part.

245 1.2 Introduction to IHE Pathology & Laboratory Medicine (PaLM)

The Pathology and Laboratory Medicine (PaLM) domain became active on January 4, 2016. This domain merges the two prior domains Laboratory (LAB) and Anatomic Pathology (AP) respectively launched in 2003 and 2006. The main reason for this merger was the recognition of a significant amount of similarities and overlaps of the two prior domain scopes and a long practice of reuse of assets (content modules, transactions) and common thinking from one another. The decision for this merger was prepared collectively along year 2015 by the LAB and AP leaderships, common secretariat and memberships, and was approved by the Board of IHE International on November 12, 2015.

The scope of the PaLM domain covers:

- 255 • clinical care related representation and exchange of digital documents, structured data and images associated with ordering, scheduling, performing and reporting diagnostic observations on in-vitro specimens collected from a patient or a non-living subject,
- the workflow, representation and exchange of structured data related to specimen management,
- 260 • the secondary use and exchange of the observation results,
- logistic and clinical data related to storage and use of specimens in bio banks,

where these observations involve to some degree a pathology laboratory with some of these specialties: surgical pathology, cytopathology, image cytometry, immunohistochemistry, autopsy, clinical chemistry, hematology, coagulation, blood gas, microbiology, allergy, auto-immunity, serology, transfusion medicine, transplant compatibility testing, fertility, assisted

265

medical procreation, cytogenetic, drug monitoring and toxicology, flow cytometry, molecular pathology specialties.

Point of care testing is part of this scope as long as a pathology laboratory is involved in the supervision of this process.

270 The current sponsors of the PaLM domain are:

- The College of American Pathologists (CAP) [<http://www.cap.org/>]
- The Japanese Association of Healthcare Information Systems Industry (JAHIS) [www.jahis.jp]
- The PHAST association [www.phast.fr]

275 **1.3 Intended Audience**

The intended audience of IHE Technical Frameworks Volume 1 (Profiles) is:

- Those interested in integrating healthcare information systems and workflows
- IT departments of healthcare institutions
- Technical staff of vendors participating in the IHE initiative

280 **1.4 Pre-requisites and Reference Material**

For more general information regarding IHE, refer to www.ihe.net. It is strongly recommended that, prior to reading this volume, the readers familiarize themselves with the concepts defined in the *IHE Technical Frameworks General Introduction*, which is published on [this page](#).

Additional reference material available includes:

285 **1.4.1 Actor Descriptions**

Actors are information systems or components of information systems that produce, manage, or act on information associated with operational activities in the enterprise.

A list of actors defined for all domains and their brief descriptions can be found as Appendix A to the *IHE Technical Frameworks General Introduction*, available on [this page](#).

290 **1.4.2 Common glossary**

A glossary consolidating the terms used across all domains of IHE can be found as Appendix D to the *IHE Technical Frameworks General Introduction*, available on [this page](#).

1.4.3 Standards Profiling and Documentation Conventions

295 The documentation conventions used by IHE to profile various standards can be found as Appendix E to the *IHE Technical Frameworks General Introduction*, available on [this page](#).

1.4.4 IHE Integration Statements

IHE Integration Statements provide a consistent way to document high level IHE implementation status in products between vendors and users.

300 The instructions and template for IHE Integration Statements can be found as Appendix F to the *IHE Technical Frameworks General Introduction*, available on [this page](#).

IHE also provides the IHE Product Registry (http://www.ihe.net/IHE_Product_Registry) as a resource for vendors and purchasers of HIT systems to communicate about the IHE compliance of such systems. Vendors can use the Product Registry to generate and register Integration Statements.

305 1.5 Overview of Technical Framework Volume 1

Volume 1 is comprised of several distinct sections:

- Section 1 provides background and reference material.
- Section 2 presents the conventions used in this volume to define the profiles.
- Sections 3 and beyond define the Pathology and Laboratory Medicine profiles, actors, and requirements in detail.

310

The appendices in Volume 1 provide clarification of uses cases or other details.

1.6 Comment Process

IHE International welcomes comments on this document and the IHE initiative. They can be submitted by sending an email to the co-chairs and secretary of the Pathology and Laboratory Medicine domain committees at palm@ihe.net.

315

1.7 Copyright Licenses

IHE International hereby grants to each Member Organization, and to any other user of these documents, an irrevocable, worldwide, perpetual, royalty-free, nontransferable, nonexclusive, non-sublicensable license under its copyrights in any IHE profiles and Technical Framework documents, as well as any additional copyrighted materials that will be owned by IHE International and will be made available for use by Member Organizations, to reproduce and distribute (in any and all print, electronic or other means of reproduction, storage or transmission) such IHE Technical Documents.

320

The licenses covered by this Copyright License are only to those copyrights owned or controlled by IHE International itself. If parts of the Technical Framework are included in products that also include materials owned or controlled by other parties, licenses to use those products are beyond the scope of this IHE document and would have to be obtained from that other party.

325

1.7.1 Copyright of Base Standards

330 IHE technical documents refer to and make use of a number of standards developed and published by several standards development organizations. All rights for their respective base standards are reserved by these organizations. This agreement does not supersede any copyright provisions applicable to such base standards.

335 Health Level Seven, Inc. has granted permission to IHE to reproduce tables from the HL7^{®1} standard. The HL7 tables in this document are copyrighted by Health Level Seven, Inc. All rights reserved. Material drawn from these documents is credited where used.

The Clinical and Laboratory Standards Institute (CLSI) has granted to IHE the permission to reproduce tables and figures from the POCT1-A standard. The POCT1-A tables and figures in the IHE Pathology and Laboratory Medicine Technical Framework are copyrighted by CLSI. All rights reserved.

340 IHE grants permission to CLSI to reproduce either parts of the Pathology and Laboratory Medicine Technical Framework.

1.8 Trademark

345 IHE[®] and the IHE logo are trademarks of the Healthcare Information Management Systems Society in the United States and trademarks of IHE Europe in the European Community. They may only be used with the written consent of the IHE International Board Operations Committee, which may be given to a Member Organization in broad terms for any use that is consistent with the IHE mission and operating principles.

1.9 Disclaimer Regarding Patent Rights

350 Attention is called to the possibility that implementation of the specifications in this document may require use of subject matter covered by patent rights. By publication of this document, no position is taken with respect to the existence or validity of any patent rights in connection therewith. IHE International is not responsible for identifying Necessary Patent Claims for which a license may be required, for conducting inquiries into the legal validity or scope of Patents Claims or determining whether any licensing terms or conditions provided in connection with
355 submission of a Letter of Assurance, if any, or in any licensing agreements are reasonable or non-discriminatory. Users of the specifications in this document are expressly advised that determination of the validity of any patent rights, and the risk of infringement of such rights, is entirely their own responsibility. Further information about the IHE International patent disclosure process including links to forms for making disclosures is available at
360 http://www.ihe.net/Patent_Disclosure_Process. Please address questions about the patent disclosure process to the secretary of the IHE International Board: secretary@ihe.net.

¹ HL7 is the registered trademark of Health Level Seven International.

1.10 History of Document Changes

This section provides a brief summary of changes and additions to this document.

Date	Document Revision	Change Summary
July 2016	7.0	Adoption of IHE_TF_Template_Vol1_Rev1.0_2014-07-01, Merger of PAT TF-1 and LAB TF-1, Incorporation of “Final Text” specifications: LAW Profile, LBL “labels and containers delivered” Option Update of the LDA Profile by removal of the transactions transferred to LAW.
June 2017	8.0	Scope of LDA and LCSD explicitly extended to anatomic pathology specialties (CP 255) Three typos corrected on LAW (CP 253)

365 **2 Pathology and Laboratory Medicine Integration Profiles**

IHE Integration Profiles offer a common language that healthcare professionals and vendors can use to discuss integration needs of healthcare enterprises and the integration capabilities of information systems in precise terms. Integration Profiles specify implementations of standards that are designed to meet identified clinical needs. They enable users and vendors to state which IHE capabilities they require or provide, by reference to the detailed specifications of the IHE Pathology and Laboratory Medicine Technical Framework.

370 IHE Integration Profiles are defined in terms of IHE actors (defined in Volume 1), transactions (defined in Volume 2), and content modules (defined in Volume 3). Actors are information systems or components of information systems that produce, manage, or act on information associated with clinical and operational activities in healthcare. Transactions are interactions between actors that communicate the required information through standards-based messages. Content modules define how the content used in a transaction is structured. A content module is specified so as to be independent of the transaction in which it appears.

380 Vendor products support an Integration Profile by implementing the appropriate actor(s) and transactions. A given product may implement more than one actor and more than one integration profile.

IHE profiles which have reached the status of *Final Text* are published as part of the domain's Technical Framework Volumes 1-4. Prior to Final Text status, IHE profiles are published independently as *Profile Supplements* with the status of *Public Comment* or *Trial Implementation*.

A list and short description of Pathology and Laboratory Medicine profiles is available [here](#). The list includes all of the profiles in this document (Final Text) as well as profiles in the Trial Implementation stage, which are specified in supplements to this Technical Framework.

The Pathology and Laboratory Medicine profiles are shown below in graphical format.

390 Each profile is represented as a box spanning across the organizations which can leverage it.

Grey boxes represent profiles still in preparation by the PaLM Technical Committee, to be published in the future as supplements to the Pathology and Laboratory Medicine Technical Framework.

395 Arrows represent required actor groupings or bindings from one profile towards another, including towards profiles of the IT Infrastructure domain.

Each profile of the Pathology and Laboratory Medicine domain is tagged with its current status. The current release of the Pathology and Laboratory Medicine Technical Framework describes only the profiles tagged "Final Text". The profiles tagged "Trial Implementation" are published as supplements to this Technical Framework.

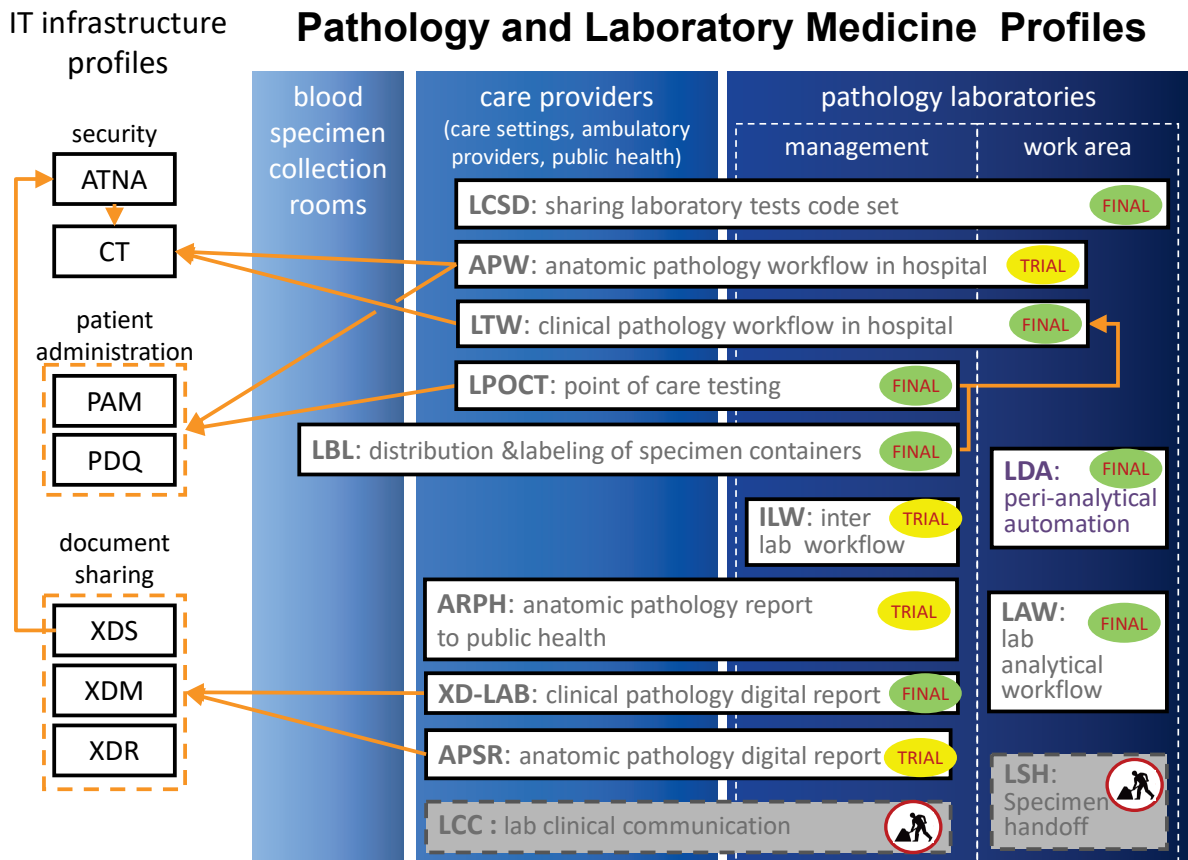

400

Figure 2-1: IHE Pathology and Laboratory Medicine Profiles

No matter what specialty they support, laboratories are key stakeholders of every profile of the Pathology and Laboratory Medicine domain. For this reason, the identification scheme of transactions of this domain uses the prefix “LAB”.

405

Thus, each transaction of the PaLM domain is identified as LAB-<number>, where <number> is the unique number assigned to this transaction in this domain.

2.1 Required Actor Groupings and Bindings

The IHE Technical Framework relies on the concepts of *required actor groupings* and *bindings*.

Required actor groupings may be defined between two or more IHE actors. Actors are grouped to combine the features of existing actors. This allows reuse of features of an existing actor and does not recreate those same features in another actor. Internal communication between grouped actors is not specified by IHE. An example of grouped actors in the IHE Radiology Scheduled Workflow Profile is the grouping between the Image Manager and Image Archive.

Additionally, required actor groupings may cross profile boundaries. For example, an XDS Document Registry is required to be grouped with an ATNA Secure Node. Required actor

415

420 groupings are defined in each profile definition in Volume 1. To comply with an actor in an IHE profile, a system must perform all transactions required for that actor in that profile. Actors supporting multiple Integration Profiles must support all of the transactions of each profile. (Note: In previous versions of IHE Technical Framework documents, the concept of profile dependencies existed. For simplification, profile dependencies have been combined with required actor groupings and are enumerated/repeated within each profile in Volume 1.)

425 Bindings refer to content modules. Bindings map data from a content module to the metadata of a specific transport profile. Bindings for content modules, and the associated concepts, are defined in Volume 3.

2.2 Security Implications

430 IHE transactions often contain information that must be protected in conformance with privacy laws, regulations and best practices. This protection is documented in the Security Considerations section of each profile, which communicates security/privacy concerns that the implementers need to be aware of, assumptions made about security/privacy pre-conditions and, where appropriate, key elements of a risk mitigation strategy to be applied.

2.3 Integration Profiles Overview

An overview of the profiles is listed at <http://www.ihe.net/Profiles>.

2.4 Product Implementations

435 As described in detail in the *IHE Technical Frameworks General Introduction* available [here](#), an implementer chooses specific profiles, actors, and options to implement for their product. To comply with an actor in an IHE profile, a system must perform all the required transactions required for that actor in that profile.

440 To communicate the conformance of a product offering with IHE profiles, implementers provide an IHE Integration Statement describing which IHE integration profiles, IHE actors and options are incorporated.

To make consumers aware of the product integration statement, enter it in the IHE Product Registry (<http://product-registry.ihe.net/>).

445 **3 Laboratory Testing Workflow (LTW) Profile**

The Laboratory Testing Workflow (LTW) Profile establishes the continuity and integrity of clinical laboratory testing and observation data produced for a healthcare institution. It covers the workflow related to tests performed and reported by a clinical laboratory in response to in-vitro diagnostic test orders created by the clinicians of the healthcare institution.

450 The profile involves a set of transactions, to maintain the consistency of order and patient data across clinical and laboratory information systems, to track specimen collection and acceptance, and to deliver the laboratory results and reports fulfilling the test orders.

3.1 LTW Actors and Transactions

455 This section defines the actors, transactions, and/or content modules in this profile. General definitions of actors are given in the Technical Frameworks General Introduction Appendix A published [here](#).

Figure 3.1-1 shows the actors directly involved in the LTW Profile and the relevant transactions between them.

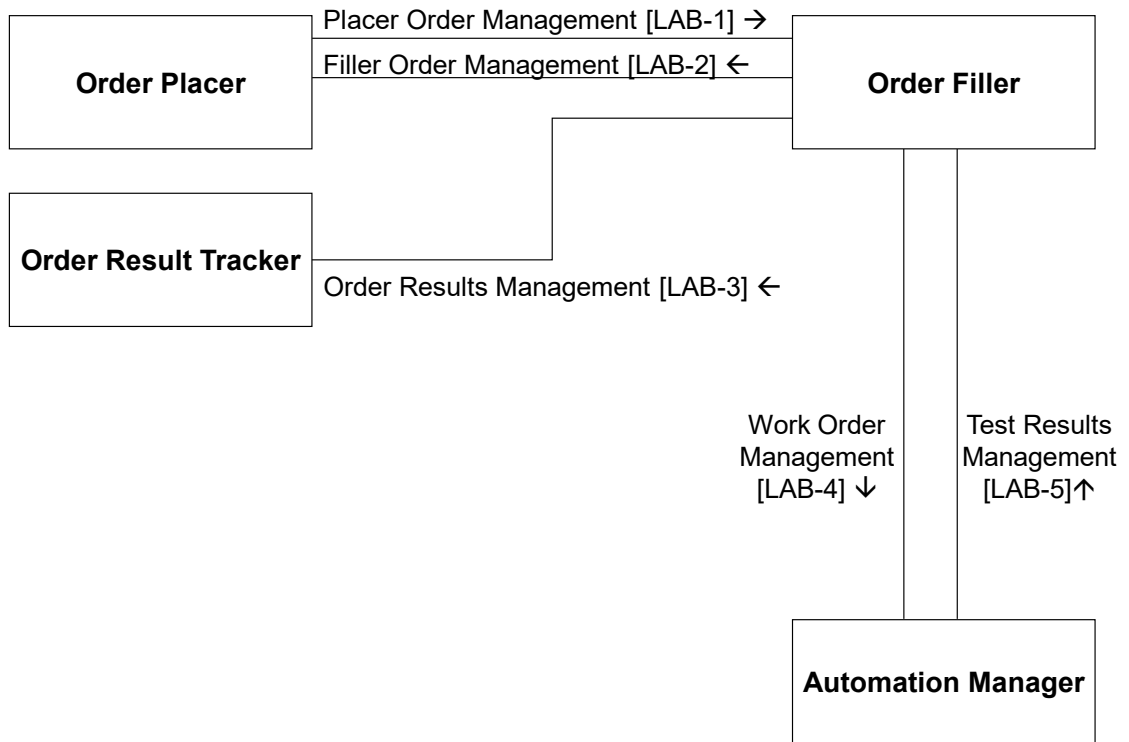

460 **Figure 3.1-1: LTW Actor Diagram**

Table 3.1-1 lists the transactions for each actor directly involved in the LTW Profile. To claim compliance with this profile, an actor shall support all required transactions (labeled “R”) and may support the optional transactions (labeled “O”).

465

Table 3.1-1: Laboratory Testing Workflow – Actors and Transactions

Actors	Transactions	Optionality	Section in Vol. 2
Order Placer	Placer Order management [LAB-1]	R	PaLM TF-2a: 3.1
	Filler Order Management [LAB-2]	R	PaLM TF-2a: 3.2
Order Filler	Placer Order management [LAB-1]	R	PaLM TF-2a: 3.1
	Filler Order Management [LAB-2]	R	PaLM TF-2a: 3.2
	Order Results management [LAB-3]	R	PaLM TF-2a: 3.3
	Work Order Management [LAB-4]	R	PaLM TF-2a: 3.4
	Test Results Management [LAB-5]	R	PaLM TF-2a: 3.5
Automation Manager	Work Order Management [LAB-4]	R	PaLM TF-2a: 3.4
	Test Results Management [LAB-5]	R	PaLM TF-2a: 3.5
Order Result Tracker	Order Results Management [LAB-3]	R	PaLM TF-2a: 3.3

3.1.1 Actor Descriptions and Actor Profile Requirements

Most requirements are documented in Transactions (Volume 2). This section documents any additional requirements on profile’s actors.

The Order Placer and Order Result Tracker Actors are implemented by the systems used by the clinical practice. The Order Filler and Automation Manager Actors are implemented by systems operated by the laboratory.

The central object exchanged between Order Placer and Order Filler Actors is an “**order**” requesting a diagnostic test or a panel of tests to be performed by the laboratory using one or more in-vitro specimens collected from the subject (patient or non-living subject). This order is also the central object exchanged between the Order Filler and the Order Result Tracker Actors.

A set of orders requested together by the ordering clinician for the same subject is called an “**order group**” in this profile. When it exists, this order group is referenced in all messages exchanged between the actors of this profile.

The unit of work exchanged between the Order Filler and the Automation Manager is a subset of an order, called a **work order**.

3.1.1.1 Actor Order Filler

Order Filler is the central actor of the LTW Profile. It is responsible for splitting any **order** or **order group** received from the clinical practice represented by the Order Placer, into the appropriate set of **work orders** for the laboratory work area and sending them to the Automation

Manager. This operation is pre-conditioned by the availability in laboratory of the appropriate in-vitro specimens needed to perform the order or order group.

490 In the opposite direction the Order Filler is responsible for consolidating the test results received from the Automation Manager into the appropriate order or order group, and for sending these consolidated results to the Order Result Tracker on the clinical side. This operation may be pre-conditioned by the **clinical validation** of these results performed by the laboratory reviewer (pathologist or biomedical scientist), who checks the clinical relevance of these results and provides an interpretation on them, that will be sent back to the ordering clinician.

495 The Order Filler is also responsible for delivering patient data updates to the Automation Manager, on all work orders, which are in process for this patient. See use case #3.

3.2 LTW Actor Options

Options that may be selected for each actor in this profile are listed in the Table 3.2-1.

500

Table 3.2-1: Laboratory Testing Workflow - Actors and Options

Actor	Option Name	Reference
Order Placer	Report Facsimile For Order Group	PaLM TF-2a: 3.1
Order Filler	Report Facsimile For Order Group	PaLM TF-2a: 3.2
Order Result Tracker	Report Facsimile For Order Group	PaLM TF-2a: 3.3
Automation Manager	none	

3.2.1 Report Facsimile For Order Group

This option is associated with transactions Placer Order Management [LAB-1] and Order Results Management [LAB-3].

505 When this option is activated:

- The Order Placer sending an order group via transaction LAB-1 MAY request an additional service requesting the Order Filler to provide the facsimile of the report in every result message related to this order group sent to the Order Result Tracker via transaction LAB-3.
- 510 • Having received this additional request from the Order Placer, the Order Filler SHALL provide in every result message carrying clinically validated results for the order group sent to the Order Result Tracker, a link to the PDF report reflecting the results present in the message. This report MAY be preliminary or final, depending on the completeness of the results set available in the message.
- 515 • Having received a result message providing a link to the PDF report associated with these results, the Order Result Tracker SHALL retrieve immediately this PDF file and SHALL store it associated with the set of results.

- 520
- The PDF facsimile of the laboratory report accompanying a result message SHALL NOT bring any extra clinical information (e.g., diagnostic, interpretation, conclusion, treatment advice) which would not be already present in the structured data of the message. It SHALL simply provide an additional synoptic view of the set of results, respecting the presentation designed by the laboratory for its paper reports.

3.3 LTW Required Actor Groupings

525 An actor from this profile (Column 1) shall implement all of the required transactions and/or content modules in this profile *in addition to* all of the transactions required for the grouped actor (Column 2).

In some cases, required groupings are defined as at least one of an enumerated set of possible actors; this is designated by merging column one into a single cell spanning multiple potential grouped actors. Notes are used to highlight this situation.

530 Section 3.5 describes some optional groupings that may be of interest for security considerations and Section 3.6 describes some optional groupings in other related profiles.

Table 3.3-1: Laboratory Testing Workflow - Required Actor Groupings

LTW Actor	Actor to be grouped with	Reference	Content Bindings Reference
Order Placer	ITI CT Consistent Time Client	ITI TF-1: 7	n.a.
Order Placer (see Note 1)	ITI PAM Patient Demographics Supplier AND ITI PAM Patient Encounter Supplier	ITI TF-1: 14	n.a.
	ITI PAM Patient Demographics Consumer AND ITI PAM Patient Encounter Supplier	ITI TF-1: 14	n.a.
	ITI PAM Patient Demographics Consumer AND ITI PAM Patient Encounter Consumer	ITI TF-1: 14	n.a.
	ITI PDQ Patient Demographics Consumer	ITI TF-1: 8	n.a.
Order Result Tracker	ITI CT Consistent Time Client	ITI TF-1: 7	n.a.
Order Result Tracker (see Note 2)	Order Placer	PaLM TF-1: 3.1	n.a.
	ITI PAM Patient Demographics Consumer AND ITI PAM Patient Encounter Consumer	ITI TF-1: 14	n.a.
	ITI PDQ Patient Demographics Consumer	ITI TF-1: 8	n.a.
Order Filler	ITI CT Consistent Time Client	ITI TF-1: 7	n.a.
Order Filler (see Note 3)	ITI PAM Patient Demographics Consumer AND ITI PAM Patient Encounter Consumer	ITI TF-1: 14	n.a.
	ITI PDQ Patient Demographics Consumer	ITI TF-1: 8	n.a.

LTW Actor	Actor to be grouped with	Reference	Content Bindings Reference
Automation Manager	ITI CT Consistent Time Client	ITI TF-1: 7	n.a.

Note 1: Order Placer SHALL be grouped with at least one of the combinations of actors listed in this row.

535

Note 2: Order Result Tracker SHALL be grouped with at least one of the combinations of actors listed in this row.

Note 3: Order Filler SHALL be grouped with at least one of the combinations of actors listed in this row.

3.4 LTW Overview

3.4.1 Concepts

540

The LTW Profile carries three kinds of work units related to one another as shown on Figure 3.4.1-1, each of these units being performed on one or more specimens collected from the subject.

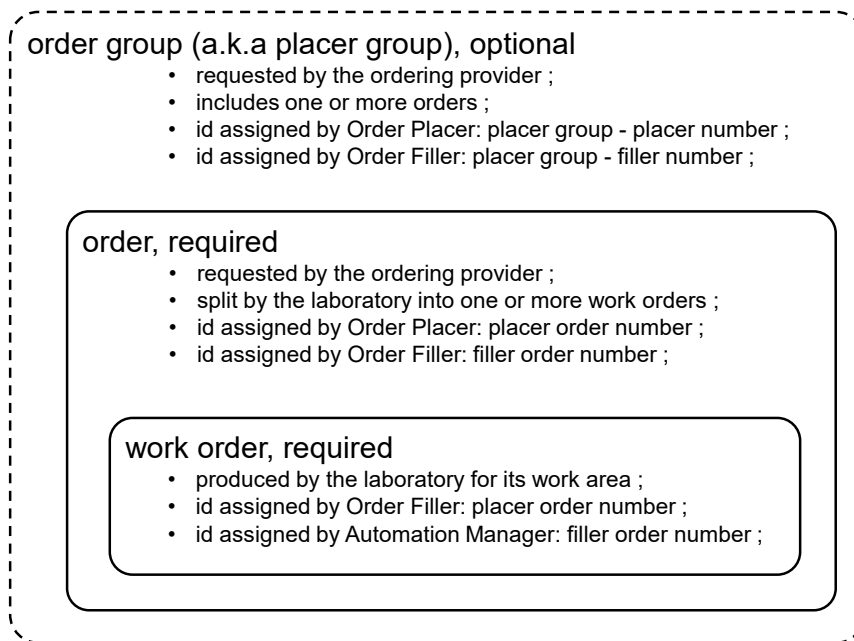

Figure 3.4.1-1: Hierarchy of work units in LTW Profile

545

LTW actors communicate about these units as represented on Figure 3.4.1-2.

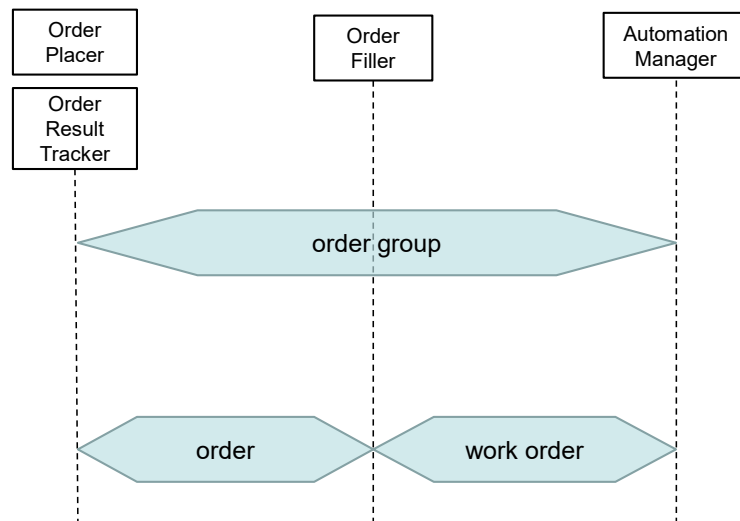

Figure 3.4.1-2: Scope of work units in LTW Profile

550 3.4.2 Use Cases

3.4.2.1 Use Case #1: Placer Order

An order group (or single order) is created by the clinical practice, and placed to the laboratory.

3.4.2.1.1 Placer Order Use Case Description

Initial part:

555 A physician requests a set of laboratory tests or batteries for a patient. The order group (or single order) is entered into the Order Placer application with relevant information needed.

The Order Placer sends a “New Order” message to the Order Filler.

560 Upon reception, the Order Filler application controls the content of each order, and if accepted, assigns a filler order number to it and notifies that number in the acknowledgement message sent back to the Order Placer application. If for some reason a battery or test cannot be accepted by the laboratory, the corresponding order is rejected and notified as such to the Order Placer.

565 In-vitro specimens needed for this order group (or order) are collected from the subject by the clinical practice or by laboratory staff or by a third party (e.g., blood collection room). Each specimen is labeled with an enterprise-wide unique identifier, and other relevant information (e.g., patient name, encounter ID, order group number).

Using the Order Filler application, the laboratory staff checks each order with the corresponding specimens. If the specimens are available and valid the order is scheduled and notified as such to the Order Placer application.

570 In case a specimen is invalid or damaged (e.g., serum hemolyzed) this specimen is rejected and the order(s) depending upon it are canceled by the Order Filler and notified as such to the Order Placer. The care giver in the ward reviewing the rejection of specimen may decide to collect a new specimen and re-order the missing set of laboratory tests (or batteries) for this patient. In this case the Order Placer sends a “New Order” message to the Order Filler containing the re-ordered requests within the already known Order Group.

575 **Middle part:**

580 The Order Filler splits the order group (or single order) into one or more work orders sent to the Automation Manager. The technical staff of the laboratory fulfills the various work orders using the Automation Manager associated devices. The splitting of specimens (aliquoting) may require the printing of additional secondary labels (either by the Order Filler or by the Automation Manager), for the identification of aliquot containers. The Automation Manager collects the results from the IVD devices, and sends them back to the Order Filler.

Final part:

585 At various stages (depending on the organization), the Order Filler sends results to the Order Result Tracker, and notifies both Order Placer and Order Result Tracker of all status changes of each order and its related results, and provides optionally a facsimile of the report fulfilling the order group.

3.4.2.1.2 Placer Order Use Case Process Flow

590 In the UML sequence diagram below describing the process flow, the blue messages (order status change notified by the Order Filler to the Order Placer) are sent only when the Order Placer and the Order Results Tracker Actors are not grouped.

Whenever the Order Placer and the Order Results Tracker are grouped together, the LAB-3 message carrying the status change and possible new results is sufficient to inform that application of the status change of the order.

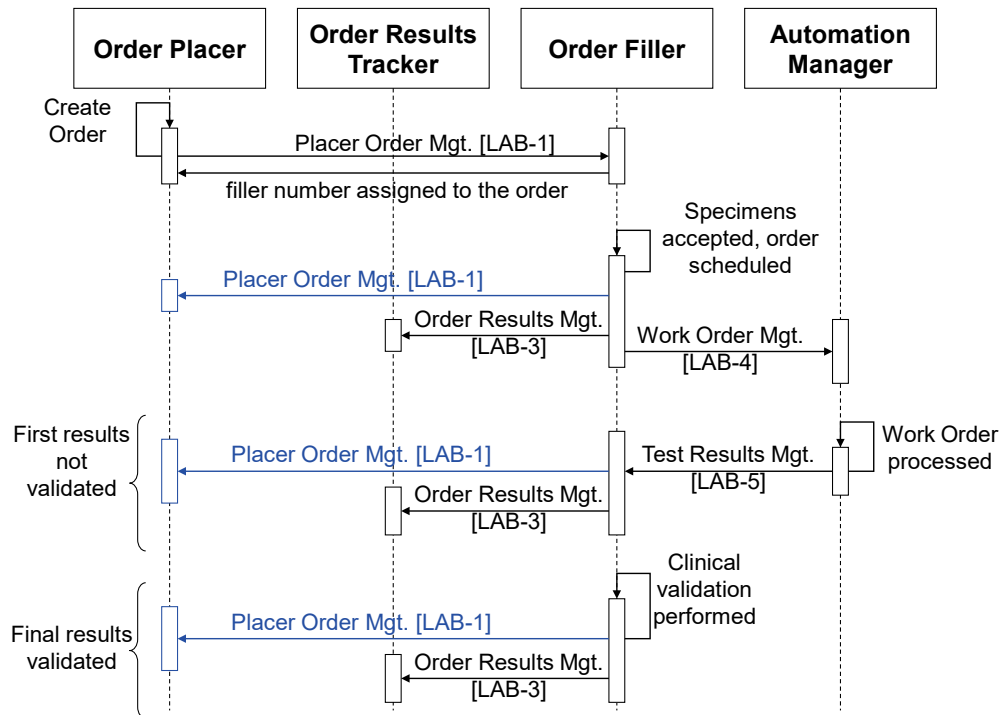

595

Figure 3.4.2.1-1: Placer Order Process Flow in LTW Profile

3.4.2.2 Use Case #2: Filler Order

An order is created by the laboratory.

3.4.2.2.1 Filler Order Use Case Description

600 **Initial part:**

Two different situations are to be considered:

- a) The laboratory staff receives an order in paper form from a clinical ward unable to access the Order Placer application.
 - b) During the processing of an order group, the laboratory decides to add an additional battery or test to that order group. The new order is to be performed on one of the existing specimens of the group.
- 605

In both situations the generated order has a filler order number. The Order Filler application notifies it to the Order Placer application, which assigns a placer order number to it, and sends this placer number back to the Order Filler.

610 The middle and final part of this use case are identical as in use case #1.

3.4.2.2.2 Filler Order Use Case Process Flow

In the UML sequence diagram below describing the process flow, the blue messages (order status change notified by the Order Filler to the Order Placer) are sent only when the Order Placer and the Order Results Tracker Actors are not grouped.

615

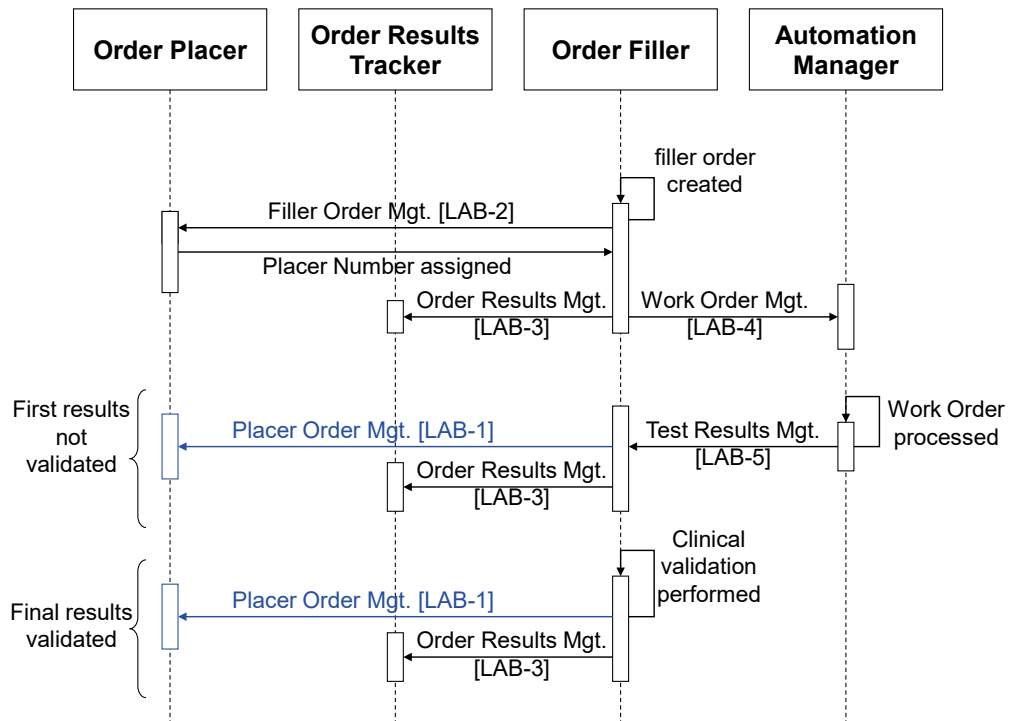

Figure 3.4.2.2.2-1: Placer Order Process Flow in LTW Profile

3.4.2.3 Use Case #3: Patient Update

620 This use case combines with use cases #1 and #2. Patient data is updated during the process of an order. All actors need to get the up to date patient data.

3.4.2.3.1 Patient Update Use Case Description

625 As specified in Section 3.3, the three actors, Order Placer, Order Filler and Order Results Tracker, are necessarily grouped with appropriate actors of the PAM Profile and/or the PDQ Profile from ITI Technical Framework. These groupings ensure that these three actors are provided in due time with up-to-date patient demographic and encounter data.

These three actors are committed to update their patient data automatically and without delay as soon as their paired PAM or PDQ Actor is notified of this update. Thus the laboratory staff and clinical ward staff keep a consistent view of patient data related to the orders they are looking at.

630 The Automation Manager receives patient demographic and encounter data only within the context of a work order. Whenever patient data changes, due to:

- Update patient information (A31 or A08)
- Patient transfer (A02)
- Transfer cancelled (A12)

635

- Change inpatient to outpatient (A07)
- Change outpatient to inpatient (A06)
- Change patient identifier (A47)
- Move patient account (A44)
- Patients merge (A40)

640 it is the responsibility of the Order Filler to forward this update to the Automation Manager for all work orders in process for this patient, using a message “update work order” of transaction LAB-4.

If there is no Work Order currently in process for that patient, the Automation Manager is not informed of the patient update.

645 **3.4.2.3.2 Patient Update Use Case Process Flow**

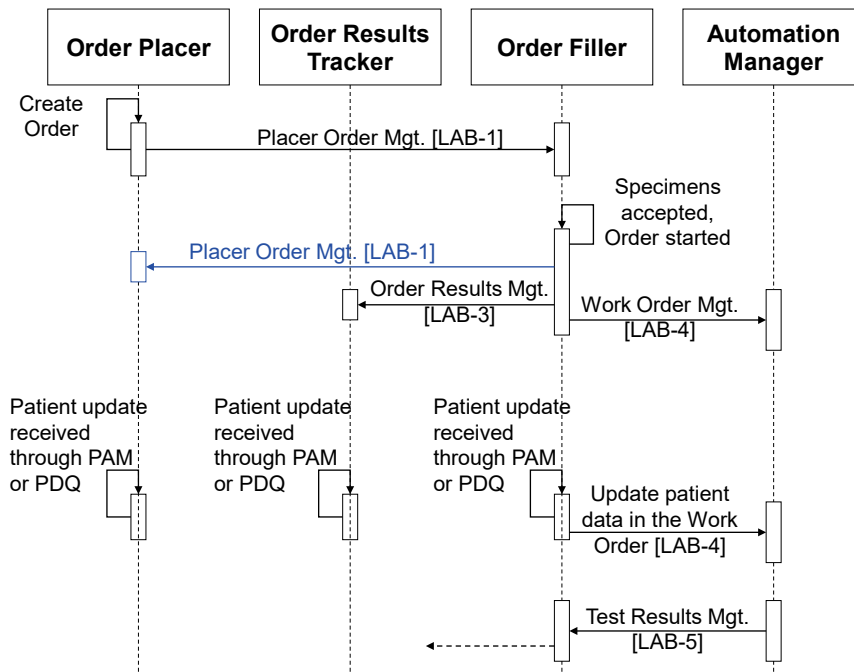

Figure 3.4.2.3.2-1: Patient Update Process Flow in LTW Profile

3.5 LTW Security Considerations

See Appendix A at the end of this volume.

650 **3.6 LTW Cross Profile Considerations**

An Analyzer Manager in Laboratory Analytical Workflow (LAW) might be grouped with Automation Manager so as to take charge of work orders and distribute them as analytical work order steps (AWOS) to its set of connected analyzers, collect the results back, and send them back to the Order Filler.

655 An Analyzer Manager in Laboratory Analytical Workflow (LAW) might be grouped with Order Filler so as to take charge of the orders and distribute them as analytical work order steps (AWOS) to its set of directly connected analyzers and collect the results back.

660 An Automation Manager in Laboratory Device Automation (LDA) might be grouped with Automation Manager so as to take charge of work orders and translate them into a number of specimen work order steps (SWOS) to be performed by some of the peri-analytical devices managed by this Automation Manager.

A Label Information Provider in Laboratory Barcode Labeling (LBL) might be grouped with Order Filler so that this system delivers the labeling instructions related to an order.

665 An Order Filler in Laboratory Point Of Care Testing (LPOCT) is usually grouped with Order Filler so that the two workflows of laboratory testing and point of care testing consolidate their orders and results seamlessly in the clinical systems and in the laboratory systems.

4 Laboratory Device Automation (LDA) Profile

670 The Laboratory Device Automation Profile covers the workflow between an Automation
Manager application (e.g., a LAS or a LIS) and a set of automated peri-analytical devices in the
laboratory. This processing includes the **pre-analytical process** of the specimen (sorting,
centrifugation, aliquoting, transportation, decapping, staining) and the **post-analytical process**
(recapping, transportation, rerun, dilution, storage and retrieval). The profile scope covers peri-
675 analytical devices in any specialties of clinical and anatomic pathology. The analytical process is
out of scope of this LDA Profile, and handled by the LAW Profile.

The Automation Manager splits a Work Order into a sequence of one or more **Specimen Work
Order Steps (SWOS)**, each of which representing a single operation to be performed on a
specimen by an automated peri-analytical device.

680 Except for the robotic transportation of the specimen, this profile does not address the handling
of an automated device through an electromechanical interface. It only carries the SWOS related
information, the status of these SWOS, and their outcome.

4.1 LDA Actors and Transactions

685 This section defines the actors, transactions, and/or content modules in this profile. General
definitions of actors are given in the Technical Frameworks General Introduction Appendix A
published [here](#).

Figure 4.1-1 shows the actors directly involved in the LDA Profile and the relevant transactions
between them.

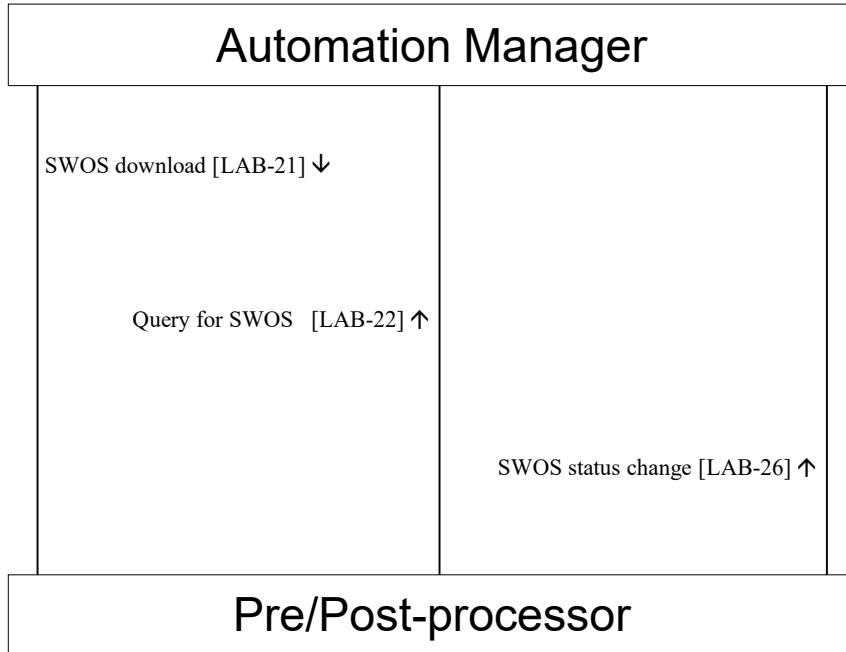

690

Figure 4.1-1: LDA Actor Diagram

Table 4.1-1 lists the transactions for each actor directly involved in the LDA Profile. To claim compliance with this profile, an actor shall support all required transactions (labeled “R”) and may support the optional transactions (labeled “O”).

695

Table 4.1-1: Laboratory Device Automation – Actors and Transactions

Actors	Transactions	Optionality	Section in Vol. 2
Automation Manager	SWOS Download [LAB-21]	R	PaLM TF-2a: 3.6
	SWOS Query [LAB-22]	R	PaLM TF-2a: 3.7
	SWOS Status Change [LAB-26]	R	PaLM TF-2a: 3.8
Pre/Post-processor	SWOS Download [LAB-21]	O	PaLM TF-2a: 3.6
	SWOS Query [LAB-22]	O	PaLM TF-2a: 3.7
	SWOS Status Change [LAB-26]	R	PaLM TF-2a: 3.8

4.1.1 Actor Descriptions and Actor Profile Requirements

The requirements are documented in the Transactions (Volume 2a).

700 **4.2 LDA Actor Options**

Options that may be selected for each actor in this profile are listed in the Table 4.2-1.

Table 4.2-1: Laboratory Device Automation - Actors and Options

Actor	Option Name	Reference
Automation Manager	none	
Pre/Post-processor	Query mode for SWOS	PaLM TF-2a: 3.7
	Download mode for SWOS	PaLM TF-2a: 3.6

705 Note 1: A device implementing the Pre/Post-processor actor SHALL support at least one of the two options *Query mode for SWOS* and *Download mode for SWOS*.

4.2.1 Query mode for SWOS

With this option, the Pre/Post-processor SHALL implement transaction LAB-22.

4.2.2 Download mode for SWOS

710 With this option, the Pre/Post-processor SHALL implement transaction LAB-21.

4.3 LDA Required Actor Groupings

An actor from this profile (Column 1) shall implement all of the required transactions and/or content modules in this profile *in addition to* all of the transactions required for the grouped actor (Column 2).

715 In some cases, required groupings are defined as at least one of an enumerated set of possible actors; this is designated by merging column one into a single cell spanning multiple potential grouped actors. Notes are used to highlight this situation.

Section 4.5 describes some optional groupings that may be of interest for security considerations and Section 4.6 describes some optional groupings in other related profiles.

720

Table 4.3-1: Laboratory Device Automation - Required Actor Groupings

LDA Actor	Actor to be grouped with	Reference	Content Bindings Reference
Automation Manager	none		n.a.
Pre/Post-processor	none		n.a.

4.4 LDA Overview

4.4.1 Concepts

725 The LDA carries Specimen Work Order Steps (SWOS). A SWOS is an atomic operation on a specimen assigned to one Pre/Post-processor. When a system is implementing Automation Manager in both LTW and LDA, one of its tasks is to split a Work Order received in LTW into as many SWOS as needed in LDA, as represented on Figure 4.4.1-1.

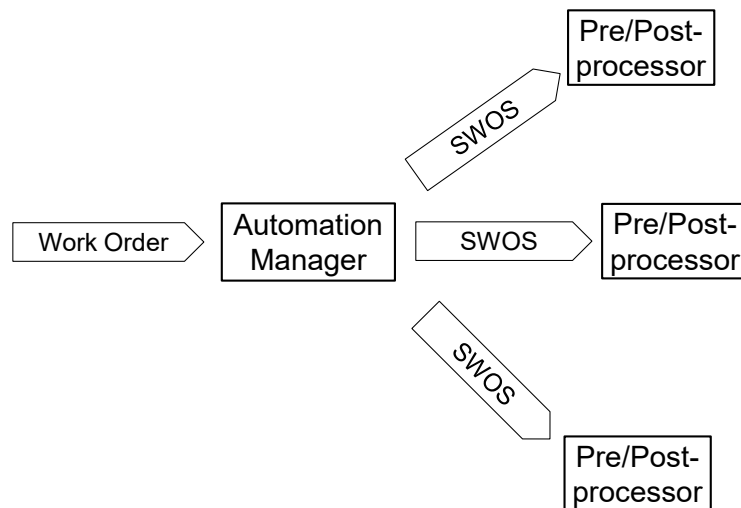

730

Figure 4.4.1-1: Scope of work units in LDA Profile

4.4.2 Use Cases

4.4.2.1 Use Case #1: SWOS Downloaded

735 The workflow is triggered by a SWOS downloaded on a Pre/Post-processor operating in download mode.

4.4.2.1.1 SWOS Downloaded Use Case Description

Initial part:

- 740
- a) The Automation Manager sends a scheduled SWOS to the Pre/Post-processor. The SWOS included the identifier of the specimen on which it is to be performed.
 - b) The specimen reached the Pre/Post-processor and is recognized (through barcode ID scanning, position identification on the carrier, or manual entry). The Pre/Post-processor selects the related SWOS from its memory.

- 745 c) Optionally the Pre/Post-processor may notify the Automation Manager of the SWOS status change.

Final part:

- r) The Pre/Post-processor performs the SWOS on that specimen.
s) The Pre/Post-processor notifies the Automation Manager of the status of the SWOS.

Exceptions handling:

750 In case the WOS has not been downloaded yet by the time the specimen is recognized, then several events may occur depending upon the Pre/Post-processor's capabilities and upon the operator's actions:

- The Pre/Post-processor skips this specimen.
- 755 • The Pre/Post-processor suspends its process, waiting for the download of the missing WOS.
- The Pre/Post-processor queries the Automation Manager with the specimen ID (shift to use case #2).

760 In the time between the SWOS download and the specimen recognition by the Pre/Post-processor, the content of the parent Work Order may be modified or canceled. Such events will result into the cancellation or the modification of the SWOS being notified to the Pre/Post-processor.

4.4.2.1.2 SWOS Downloaded Use Case Process Flow

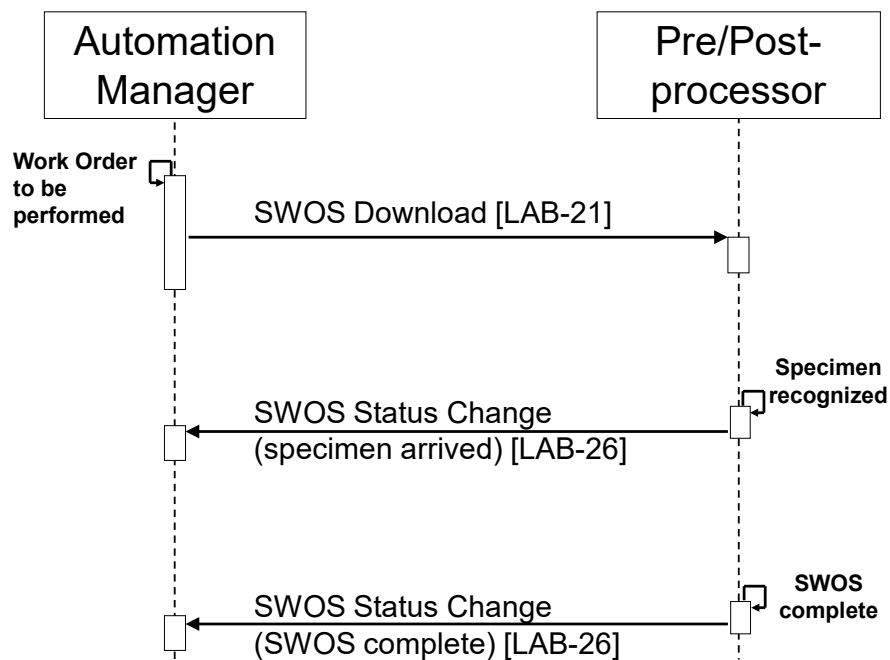

765

Figure 4.4.2.1.2-1: SWOS Downloaded Process Flow in LDA Profile

4.4.2.2 Use Case #2: SWOS Queried

The workflow is triggered by a specimen reaching the Pre/Post-processor operating in query mode.

770

4.4.2.2.1 SWOS Queried Use Case Description

Initial part:

- a) The Automation Manager schedules a SWOS.
- b) The Pre/Post-processor recognizes the specimen (barcode scanning, or manual entry) and queries the Automation Manager with the specimen ID.
- c) The Automation Manager responds to the query with the SWOS to be performed.

775

Final part: identical to use case#1

Exceptions handling:

The specimen may reach the Pre/Post-processor before the SWOS is scheduled by the Automation Manager. In that case the query in step b) is unsuccessful. The response sent in step c) will be “unknown specimen, no pending SWOS for it”. Then, the Pre/Post-processor skips this specimen and will try a new query later.

780

4.4.2.2.2 SWOS Queried Use Case Process Flow

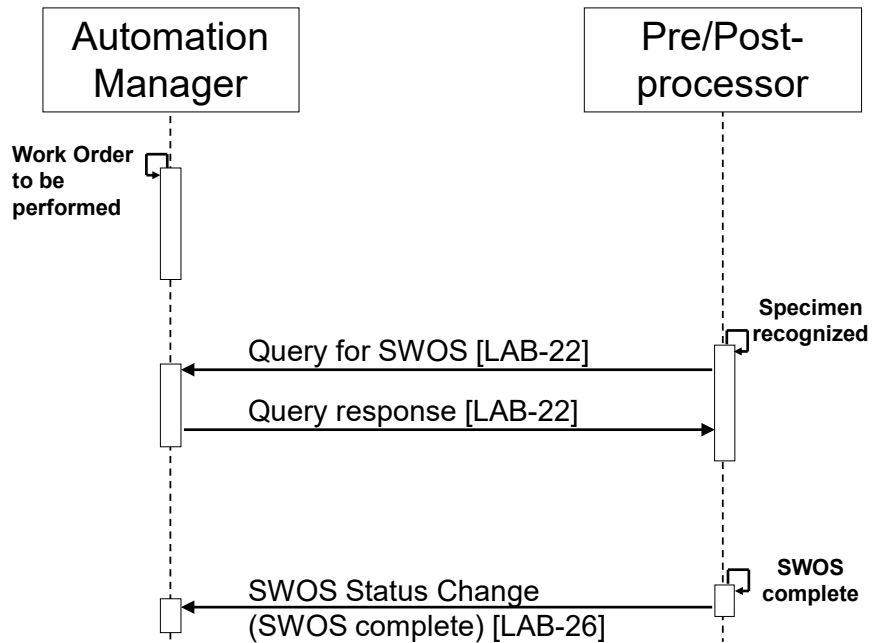

Figure 4.4.2.2.2-1: SWOS Queried Process Flow in LDA Profile

785

4.5 LDA Security Considerations

See Appendix A at the end of this volume.

4.6 LDA Cross Profile Considerations

790

An Automation Manager in Laboratory Testing Workflow (LTW) might be grouped with Automation Manager in Laboratory Device Automation (LDA) so as to take charge of work orders and distribute them as SWOS to its set of connected peri-analytical devices.

5 Laboratory Analytical Workflow (LAW) Profile

795 The LAW Integration Profile supports the analytical workflow between analyzers of the clinical laboratory and the IT systems managing their work.

This LAW Profile covers the workflow of “Analytical Work Order Steps” (**AWOS**) between an **Analyzer Manager** application (e.g., a LAS or a LIS) and an **Analyzer** (an IVD device). This workflow handles the processing of IVD tests by the Analyzer, on specimen materials. Both patient and quality control (QC) specimens are in scope.

800 All specialties of clinical laboratories (including blood bank testing) are in scope.

Tests performed on the point of care by the ward staff or the patient are out of scope of this profile, and addressed by the LPOCT Profile instead.

805 An AWOS is an analytical service to be performed by an analyzer on a specimen. The AWOS is ordered by means of a code representing this analytical service. The code may represent an elementary test (e.g., “measure the glucose level of the specimen”) or a panel of several elementary tests. In all cases the analytical service is expected to produce observations on the specimen. The results of these observations are transferred back to the Analyzer Manager.

The AWOS does not say how to perform the analytical service. The electromechanical handling of an analyzer is out of scope of this Profile.

810 The specimen may arrive on an Analyzer before or after the AWOS referring to it has been delivered. To perform the tests the Analyzer needs to have both the specimen and the AWOS.

Some Analyzers, such as those that perform a fixed test menu on all specimens, may offer a unidirectional interface, supporting only the transfer of the test results to the Analyzer Manager.

815 Most Analyzers offer a bi-directional interface supporting both the **AWOS transfer** to the Analyzer and the **result transfer** back to the Analyzer Manager. This Profile covers two distinct modes for the AWOS transfer to bi-directional analyzers:

- **Broadcast mode:** The Analyzer Manager broadcasts AWOSs to the assigned Analyzers, as soon as they are scheduled. The Analyzer receives unsolicited AWOSs, and stores them until it gets the corresponding specimens to perform them.

820 • **Query mode:** The Analyzer queries for the AWOS related to a specimen available for testing, or queries for all pending AWOSs assigned to this Analyzer.

This Profile does not consider a mixed configuration of “query” and “broadcast” to be a valid mode for an Analyzer, as this greatly complicates the use cases.

825 In addition, this Profile assumes that either Analyzers query for a given AWOS or a given AWOS is broadcast to the Analyzers. In other words, the Profile does not support a mix of Analyzers in “query” mode and Analyzers in “broadcast” mode that can perform the same AWOS.

5.1 LAW Actors and Transactions

830 This section defines the actors, transactions, and/or content modules in this profile. General definitions of actors are given in the Technical Frameworks General Introduction Appendix A published [here](#).

Figure 5.1-1 shows the actors directly involved in the LAW Profile and the relevant transactions between them.

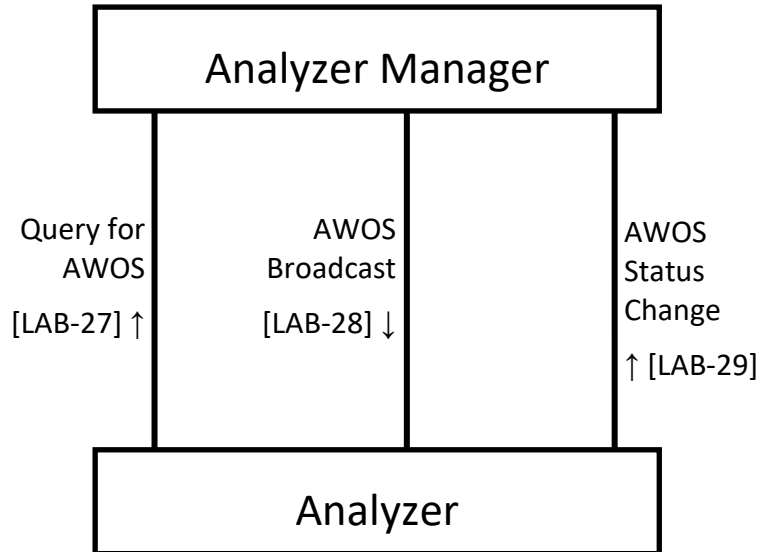

835

Figure 5.1-1: LAW Actor Diagram

840 Table 5.1-1 lists the transactions for each actor directly involved in the LAW Profile. To claim compliance with this profile, an actor shall support all required transactions (labeled “R”) and may support the optional transactions (labeled “O”).

845

Table 5.1-1: Laboratory Analytical Workflow – Actors and Transactions

Actors	Transactions	Optionality	Section in Vol. 2
Analyzer Manager	Query for AWOS [LAB-27]	R	PaLM TF-2b: 3.27
	AWOS Broadcast [LAB-28]	R ²	PaLM TF-2b: 3.28
	AWOS Status Change [LAB-29]	R ²	PaLM TF-2b: 3.29
Analyzer	Query for AWOS [LAB-27]	O ¹	PaLM TF-2b: 3.27
	AWOS Broadcast [LAB-28]	O ^{1,2}	PaLM TF-2b: 3.28
	AWOS Status Change [LAB-29]	R ²	PaLM TF-2b: 3.29

850 Note 1: An Analyzer SHALL support both LAB-27 and LAB-28 or none of these two transactions.

Note 2: The transaction MAY contain enhanced information. The usage of the enhanced information is discussed in 5.2 and in PaLM TF-2b:2.2.4 Profile Types.

5.1.1 Actor Descriptions and Actor Profile Requirements

855 Most requirements are documented in Transactions (Volume 2). This section documents any additional requirements on profile's actors.

5.1.1.1 Actor Analyzer

An Analyzer offering a bi-directional interface SHALL support the query mode and this mode SHALL represent its default configuration and behavior.

860 An Analyzer offering a bi-directional interface MAY be configurable so as to operate in broadcast mode.

An Analyzer SHALL acknowledge the Analyzer Manager with its intent to accept or reject an AWOS received from it.

5.1.1.2 Actor Analyzer Manager

865 The Analyzer Manager SHALL assign a unique identifier (called AWOS ID) to each AWOS. It is the responsibility of the Analyzer Manager to guarantee (e.g., use of unique IDs or establishing a reasonable period of time for the reuse of IDs) that the assignment of AWOS IDs can be used to uniquely identify each AWOS.

An Analyzer Manager SHALL support bi-directional communication.

870 An Analyzer Manager SHALL be able to respond to all types of queries sent by an Analyzer, according to the query options supported by this Analyzer.

An Analyzer Manager SHALL be able to handle in broadcast mode the AWOS transfer to an Analyzer.

875 An Analyzer Manager SHALL assume that all bi-directional Analyzers operate in query mode, unless configured otherwise.

The Analyzer Manager SHOULD adjust its behavior to the combination of options that has been individually selected and configured by each Analyzer connected to it, providing the enhanced information associated with an option if and only if the recipient Analyzer supports that particular option.

880 **5.2 LAW Actor Options**

The LAW Profile defines a basic common set of mandatory information for the AWOS transfer and result transfer. The AWOS transfer information can be used by any Analyzer to perform the proper test on the proper specimen, while the result transfer information can be used by any Analyzer Manager to record the outcome of the test.

885 However, Analyzers have different capabilities related to performing tests and reporting results. For example, an Analyzer may provide the capability to perform a clinical evaluation of the test result. This might be accomplished automatically through the use of a rule engine, or the Analyzer might provide the capability for a user to manually evaluate the results through the user interface. In order to do so, the Analyzer must receive additional, or enhanced, information from
890 the Analyzer Manager in the AWOS transfer.

Similarly, the Analyzer may provide enhanced information to the Analyzer Manager in the result transfer, such as identifying the substances that contributed to the test, or providing external results by reference.

All enhanced information provided in the AWOS or result transfer will be considered optional.

895 The options for this profile are listed in Table 5.2-1. These options cover most of the enhanced information supported by the Profile for the AWOS and result transfers.

All options are available to the Analyzer. An IVD device implementing this actor may implement any combination of these options, or none of them.

900 The last three options are also available to the Analyzer Manager. A system implementing this actor may choose whether to implement any combination of these three options, or none of them.

Table 5.2-1: Laboratory Analytical Workflow - Actors and Options

Actor	Option Name	Transactions	Reference	Profile Option Identifier
Analyzer	Bi-directional Communication	LAB-27 LAB-28	PaLM TF-1: 5.2.1, 5.4.2.1, 5.4.2.2, 5.4.2.3 PaLM TF-2b: 2.2.4.1, 3.27 and 3.28	LAW_QUERY_WOS
	Query by Isolate	LAB-27 LAB-28	PaLM TF-1:5.2.2 PaLM TF-2b: 2.2.4.2 and 3.27	LAW_QUERY_ISOLATE
	Query by Rack	LAB-27 LAB-28	PaLM TF-1:5.2.3 PaLM TF-2b: 2.2.4.2 and 3.27	LAW_QUERY_RACK

Actor	Option Name	Transactions	Reference	Profile Option Identifier
	Query by Tray	LAB-27 LAB-28	PaLM TF-1: 5.2.4 PaLM TF-2b: 2.2.4.2 and 3.27	LAW_QUERY_TRAY
	Query All	LAB-27 LAB-28	PaLM TF-1:5.2.5 PaLM TF-2b: 2.2.4.2 and 3.27	LAW_QUERY_ALL
	Contributing Substances	LAB-29	PaLM TF-1: 5.2.6 PaLM TF-2b: 2.2.4.3	LAW_CONTRIB_SUB
	Dilutions	LAB-28 ¹ LAB-29	PaLM TF-1: 5.2.7 PaLM TF-2b: 2.2.4.4	LAW_DILUTIONS
	Patient Demographics	LAB-28 ¹ LAB-29	PaLM TF-1: 5.2.8 PaLM TF-2b: 2.2.4.5	LAW_PAT_DEM
	Reflex	LAB-29	PaLM TF-1: 5.2.9, 5.4.2.7 PaLM TF-2b:2.2.4.6	LAW_REFLEX
	Rerun	LAB-29	PaLM TF-1: 5.2.10, 5.4.2.5 PaLM TF-2b:2.2.4.7	LAW_RERUN
	Analyzer Manager Rerun and Reflex	LAB-28 ¹	PaLM TF-1: 5.2.11, 5.4.2.6 PaLM TF-2b: 2.2.4.8	LAW_AM_RR
	Analyzer Manager Rerun and Reflex Control	LAB-28 ¹	PaLM TF-1: 5.2.12 PaLM TF-2b: 2.2.4.9	LAW_AM_RR_CONTROL
	AWOS Priority	LAB-28 ¹ LAB-29	PaLM TF-1: 5.2.13 PaLM TF-2b: 2.2.4.10,	LAW_AWOS_PRIORITY
	Specimen Details	LAB-28 ¹	PaLM TF-1: 5.2.14 PaLM TF-2b: 2.2.4.11,	LAW_SPECIMEN
	Container Details	LAB-28 ¹	PaLM TF-1: 5.2.15 PaLM TF-2b: 2.2.4.12	LAW_CONTAINER
	Mass Spectrometry	LAB-29	PaLM TF-1: 5.2.16 PaLM TF-2b: 2.2.4.13	LAW_MASS_SPEC
	External Result	LAB-29	PaLM TF-1: 5.2.17, 5.4.2.12 PaLM TF-2b: 2.2.4.15	LAW_RESULT_EXT
	Related Observations	LAB-28 ¹	PaLM TF-1: 5.2.18 PaLM TF-2b: 2.2.4.14	LAW_REL_OBS
	Pooling on Analyzer	LAB-28 LAB-29	PaLM TF-1: 5.2.19, 5.4.2.10 PaLM TF-2b: 2.2.4.16	LAW_POOL_AN
	Pooling Outside of Analyzer	LAB-28 LAB-29	PaLM TF-1: 5.2.20, 5.4.2.11 PaLM TF-2b: 2.2.4.17	LAW_POOL_NOAN
Analyzer Manager	Related Observations	LAB-28 ¹	PaLM TF-1: 5.2.18 PaLM TF-2b: 2.2.4.14	LAW_REL_OBS
	Pooling on Analyzer	LAB-28 LAB-29	PaLM TF-1: 5.2.19, 5.4.2.10 PaLM TF-2b: 2.2.4.16	LAW_POOL_AN
	Pooling Outside of Analyzer	LAB-28 LAB-29	PaLM TF-1: 5.2.20, 5.4.2.11 PaLM TF-2b: 2.2.4.17	LAW_POOL_NOAN

Note 1: The Analyzer Manager SHOULD send the enhanced information associated with the profile option in this transaction only when the Analyzer supports the profile option.

905

5.2.1 Bi-directional Communication

When supporting this option, the Analyzer:

- SHALL offer a bi-directional interface for AWOS transfer and result transfer;
- SHALL be capable of querying the Analyzer Manager for an AWOS, using the specimen container identifier as unique query parameter.

910

5.2.2 Query by Isolate

When supporting this option, the Analyzer:

- SHALL offer a bi-directional interface for AWOS transfer and result transfer;
- SHALL be capable of querying the Analyzer Manager for an AWOS, using the isolate identifier and the primary specimen container identifier as query parameters.

915

5.2.3 Query by Rack

When supporting this option, the Analyzer:

- SHALL offer a bi-directional interface for AWOS transfer and result transfer;
- SHALL be capable of querying the Analyzer Manager for an AWOS, using the rack identifier and the specimen position on the rack as query parameters.

920

5.2.4 Query by Tray

When supporting this option, the Analyzer:

- SHALL offer a bi-directional interface for AWOS transfer and result transfer;
- SHALL be capable of querying the Analyzer Manager for an AWOS, using the tray identifier and the specimen position on the tray as query parameters.

925

5.2.5 Query All

When supporting this option, the Analyzer:

- SHALL offer a bi-directional interface for AWOS transfer and result transfer;
- SHALL be capable of querying the Analyzer Manager for all pending AWOSs assigned to this Analyzer.

930

5.2.6 Contributing Substances

This option is used by Analyzers that identify substances or disposables (e.g., reagents) that contributed to the result.

When supporting this option, the Analyzer:

- 935
- SHALL be capable of providing the identifier and type of the substances that contributed to the test, along with the test result;
 - SHOULD be capable of providing the container identifier and manufacturer lot number of the substances or disposables that contributed to the test, along with the test result.

5.2.7 Dilutions

940 This option is used by Analyzers that support dilution instructions received with an AWOS, and that report back the actual dilution they have performed.

When supporting this option, the Analyzer:

- SHALL be capable of receiving and applying the automatic dilution specification (factor or type of dilution) provided by the Analyzer Manager along with an AWOS transfer;
- 945
- SHALL be capable of providing the actual dilution (factor or type of dilution) that was applied for the run of a test, along with the result transfer.

The Analyzer Manager SHOULD send automatic dilution specification only when the Analyzer supports this option.

5.2.8 Patient Demographics

950 This option is used by Analyzers consuming patient demographic data.

When supporting this option, the Analyzer:

- SHALL be capable of receiving and using the patient name, identifier, date of birth, sex, race, as well as the class of encounter and assigned patient location, sent alongside an AWOS by the Analyzer Manager;
- 955
- SHALL be capable of sending back to the Analyzer Manager the patient name, identifier, date of birth, sex and race, as well as the class of encounter and assigned patient location, in result transfer;
 - SHALL be capable of echoing back to the Analyzer Manager the patient name, identifier, date of birth, sex and race in its messages acknowledging an AWOS.

960 The Analyzer Manager SHOULD send patient demographic data only when the Analyzer supports this option.

5.2.9 Reflex

This option is used by Analyzers that decide and perform reflex tests, and report their results as such.

965 When supporting this option the Analyzer SHALL be capable of performing reflex tests in the context of an AWOS and sending their results to the Analyzer Manager, in child orders of this AWOS.

5.2.10 Rerun

970 This option is used by Analyzers that perform multiple runs on their own initiative, and report their results as such.

When supporting this option the Analyzer SHALL be capable of performing multiple runs of a test and sending their results back to the Analyzer Manager, providing a run identifier for each result.

5.2.11 Analyzer Manager Rerun and Reflex

975 This option is used by Analyzers to execute a rerun or reflex testing decision made by the Analyzer Manager, and received as a new AWOS.

When supporting this option the Analyzer SHALL be capable of interpreting the analyte repeat status (original run, reflex, or rerun) of a test ordered by an AWOS sent by the Analyzer Manager.

980 The Analyzer Manager SHOULD send the analyte repeat status (original run, reflex, or rerun) of a test ordered by an AWOS only when the Analyzer supports this option.

5.2.12 Analyzer Manager Rerun and Reflex Control

This option is used by Analyzers that allow the Analyzer Manager to control the rerun and reflex testing process on the Analyzer side.

985 When supporting this option the Analyzer SHALL be capable of interpreting the rerun and reflex conditions associated with an AWOS sent by the Analyzer Manager.

The Analyzer Manager SHOULD send the rerun and reflex conditions associated with an AWOS only when the Analyzer supports this option.

5.2.13 AWOS Priority

990 This option is used by Analyzers that allow the Analyzer Manager to assign a priority to the AWOS request, and that report back the actual priority that has been applied.

When supporting this option the Analyzer SHALL be capable of interpreting the requested priority for an AWOS received from the Analyzer Manager, and to report the actual priority that was used when sending the results back to the Analyzer Manager.

995 The Analyzer Manager SHOULD send the priority for an AWOS only when the Analyzer supports this option.

5.2.14 Specimen Details

This option is used by Analyzers that support receiving additional details about a specimen.

When supporting this option, the Analyzer:

- 1000
- SHALL be capable of receiving and using the specimen details (specimen ID, ID of parent specimens that contributed to the current specimen, collection method, source site,

risk, time of collection, time of reception), sent alongside an AWOS by the Analyzer Manager;

- 1005
- SHALL be capable of sending back to the Analyzer Manager the specimen ID and the ID of parent specimens in its result messages.

The Analyzer Manager SHOULD send specimen details only when the Analyzer supports this option.

5.2.15 Container Details

1010 This option is used by Analyzers that support receiving enhanced information about the specimen container.

When supporting this option, the Analyzer SHALL be capable of receiving and using the specimen container enhanced information (carrier type, container volume, available specimen volume, volume units and dilution factor), sent along an AWOS by the Analyzer Manager.

1015 The Analyzer Manager SHOULD send specimen container enhanced information only when the Analyzer supports this option.

5.2.16 Mass Spectrometry

This option is used by Analyzers that report mass spectrometry results.

When supporting this option, the Analyzer SHALL be capable of providing a probability associated with a result.

5.2.17 External Result

1020 This option is used by Analyzers that support reporting results as a reference to an external location where the actual result can be retrieved.

When supporting this option, the Analyzer SHALL be capable of reporting results as a reference pointer to a location in an external repository, qualified as persistent or temporary.

5.2.18 Related Observations

1025 This option is used by Analyzers that support receiving related lab observations, and by Analyzer Managers that support providing these related lab observations.

1030 When supporting this option, the Analyzer SHALL be capable of receiving and using observation results (clinical, physiological or diagnostic test) alongside an AWOS sent by the Analyzer Manager.

When supporting this option, the Analyzer Manager:

- 1035
- SHALL be capable of sending observation results (clinical, physiological or diagnostic test) when broadcasting an AWOS;
 - SHOULD send observation results accompanying an AWOS only when the Analyzer supports this option.

5.2.19 Pooling on Analyzer

This option is used when the Analyzer supports pooling of patient specimens requested by the Analyzer Manager.

1040 When supporting this option the Analyzer SHALL be capable of interpreting the pooling of patient specimens requested by the Analyzer Manager for a particular test or panel, and of reporting the actual pooling that was used when sending back the results.

When supporting this option the Analyzer Manager SHALL be capable of requesting the pooling of patient specimens for a particular test or panel, and interpreting the actual pooling that was performed by the Analyzer.

1045 **5.2.20 Pooling Outside of Analyzer**

This option is used when the Analyzer requires information about the pooling of patient specimens that happened outside of the Analyzer.

1050 When supporting this option the Analyzer SHALL be capable of interpreting the pooled specimen characteristics (specimen pooled or not, number of patient specimens in the pool) received alongside an AWOS, and to echo them back in the acknowledgement of this AWOS.

When supporting this option the Analyzer Manager SHALL be capable of sending the pooled specimen characteristics (specimen pooled or not, number of patient specimens in the pool) alongside an AWOS.

5.3 LAW Required Actor Groupings

1055 An actor from this profile (Column 1) shall implement all of the required transactions and/or content modules in this profile *in addition to* all of the transactions required for the grouped actor (Column 2).

1060 In some cases, required groupings are defined as at least one of an enumerated set of possible actors; this is designated by merging column one into a single cell spanning multiple potential grouped actors. Notes are used to highlight this situation.

Section 5.5 describes some optional groupings that may be of interest for security considerations and Section 5.6 describes some optional groupings in other related profiles.

Table 5.3-1: Laboratory Analytical Workflow - Required Actor Groupings

LAW Actor	Actor to be grouped with	Reference	Content Bindings Reference
Analyzer	none		n.a.
Analyzer Manager	none		n.a.

1065 **5.4 LAW Overview**

5.4.1 Concepts

The Analyzer Manager receives Work Orders from upstream, and splits them into analytical work order steps (AWOS). Each AWOS represents an IVD test or panel assigned to an Analyzer, to be performed on a specimen in a container.

1070 An AWOS is assigned a unique identifier (AWOS ID) by the Analyzer Manager. This AWOS ID is memorized by the Analyzer and included in all messages exchanged back and forth related to that AWOS. The AWOS sent by the Analyzer Manager also keeps track of the Work Order that spawned it, carrying its Work Order ID, as shown in Figure 5.4.1-1.

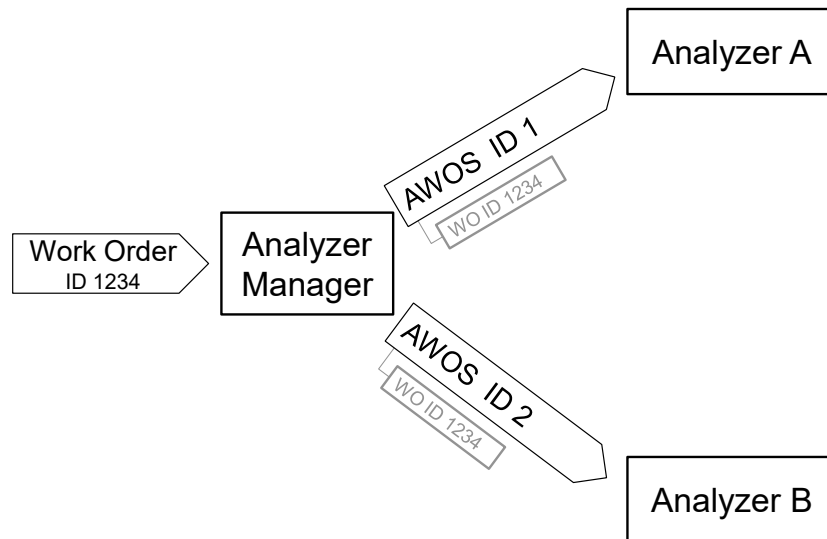

1075 **Figure 5.4.1-1: Splitting of a Work Order into a number of AWOSs**

The results of the tests are sent to the Analyzer Manager, automatically and/or triggered by a manual operation from the technician operating the Analyzer.

1080 The Profile includes the Analyzer’s ability to accept or reject an AWOS, with the notice of specimen arrival to the Analyzer Manager. It also includes the optional ability of an Analyzer to add a new reflex test to the panel or single test originally requested by the Analyzer Manager, given the preliminary results obtained. The reflex test is created in a child AWOS.

1085 An AWOS is bound to a single specimen unambiguously identified through a specimen container ID and/or a geographic position (carrier, tray, plate ...) on the analyzer. The specimen container ID is a mandatory datum of the transactions dealing with the AWOS. Moreover, the specimen container ID is usually visible on the specimen container (e.g., as a bar-coded label

sticker), so as to be read and recognized by the analyzer. More than one AWOS may be bound to the same specimen.

1090 In addition to the specimen identification, the AWOS usually carries a number of specimen properties (e.g., specimen type, target site, specimen role (patient / QC), specimen pooled or not, dilution factor, time of specimen collection, collector...).

Observation result tracking implies the ability of each actor (Analyzer, Analyzer Manager) to store the raw results, before refining, converting or interpreting them. This safe storage is not described in this Profile.

1095 **5.4.2 Use Cases**

Use cases related to patient and QC specimen testing defined in this section primarily rely on Work Orders received by the Analyzer Manager, and split into AWOSs, each of which being scheduled on an Analyzer according to the organization of the laboratory work area.

5.4.2.1 Use Case #1: AWOS Broadcast

1100 In this use case the Analyzer Manager broadcasts to the Analyzer the scheduled work list of AWOSs before the related specimens are made available to the Analyzer.

Laboratories may have multiple Analyzers with similar analytical capabilities for fault tolerance redundancy or to keep up with the workload. When an AWOS is scheduled on more than one analyzer, upon notification of AWOS completion by the Analyzer that performed it, the
1105 Analyzer Manager shall cancel the other redundant AWOS awaiting execution on other Analyzers.

5.4.2.1.1 AWOS Broadcast Use Case Description

Initial part of the scenario:

- 1110 a. The Analyzer Manager broadcasts a scheduled work list of AWOSs to the Analyzer(s). A work list may be sent to an Analyzer in one or more transmissions, although it is more efficient to send a work list in one transmission. The Analyzer commits the list of received AWOS to memory, and acknowledges them back to the Analyzer Manager.
- 1115 b. An Analyzer recognizes the specimen container (through barcode ID scanning, position identification on the carrier, or manual entry) and selects the set of AWOSs related to that specimen from its memory.

Final part of the scenario:

- a. The Analyzer performs the AWOS (one or more) on that specimen.
- b. The Analyzer may optionally notify the Analyzer Manager with the “in progress” status for the ordered tests.
- 1120 c. The Analyzer notifies the Analyzer Manager of the completion of the AWOS (one or more). The notification message contains the test results with their properties. These results may be conveyed in one or more messages.

1125 The Analyzer Manager must support receiving AWOS test results reported over a period of time in addition to receiving multiple test results for an AWOS at the same time. The reported test results can include both progress status and a final result for a given AWOS.

- d. If the AWOS was sent to multiple Analyzers operating in broadcast mode, the Analyzer Manager cancels this AWOS on the other Analyzers that received it.

Exception handling:

1130 v. In case the Analyzer has not yet received the AWOS when it recognizes the specimen container, several events may occur depending upon the Analyzer's capabilities and operator's actions:

- 1. The Analyzer skips this specimen.
- 2. The analyzer suspends processing of the specimen and waits for the arrival of the missing AWOS.

1135 3. The AWOS is created on the Analyzer (transition to use case 5.4.2.4).

- w. In the time between receipt of the AWOS and the specimen recognition by the Analyzer, the content of the Work Order may be modified (patient data corrected, tests suppressed, added or replaced. Such events will trigger the cancellation of the original AWOS on the Analyzer Manager, and the broadcast of this cancellation to all Analyzers that had received it.

1140 1. The Analyzer Manager requests the Analyzers to cancel the AWOS.

1145 2. It is up to the Analyzer to evaluate the state of the AWOS and determine if cancellation is possible. If an Analyzer cannot cancel the AWOS, it sends a "cannot cancel" acknowledgement to the Analyzer Manager, and continues the process of this AWOS. Otherwise the AWOS is actually cancelled on the Analyzer, and the acknowledgement "canceled as requested" sent back to the Analyzer Manager.

- x. In case the AWOS is rejected by the Analyzer, it is up to the Analyzer Manager to determine the next steps for that AWOS. Possible actions include:

1150 1. Send the AWOS to another Analyzer.

3. Ask the operator to manually process the AWOS.

4. Notify the operator that the AWOS could not be performed.

5.4.2.1.2 AWOS Broadcast Use Case Process Flow

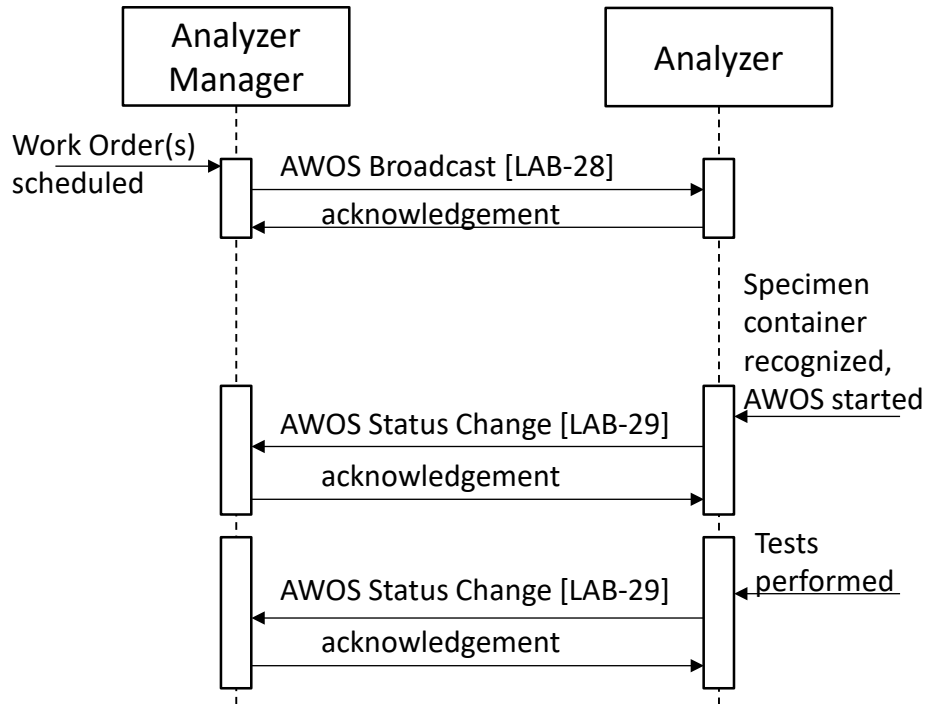

Figure 5.4.2.1.2-1: AWOS Broadcast Process Flow in LAW Profile

1155

The LAB-29 message conveying the event “AWOS started” is optional. The choice of triggering this message is left up to the Analyzer.

There may be more than one LAB-29 message conveying the results for the AWOS.

5.4.2.2 Use Case #2: Query ALL

1160

This use case is very similar to use case #1, with the Analyzer Manager broadcasting to the Analyzer the scheduled work list of AWOSs before the related specimens are made available to the Analyzer.

5.4.2.2.1 Query ALL Use Case Description

1165

The only difference with use case #1 is the initial event: Instead of being unsolicited, the AWOS broadcast is triggered by a Query for all AWOSs available, sent by the Analyzer.

The exception handling is similar to use case#1

5.4.2.2.2 Query ALL Use Case Process Flow

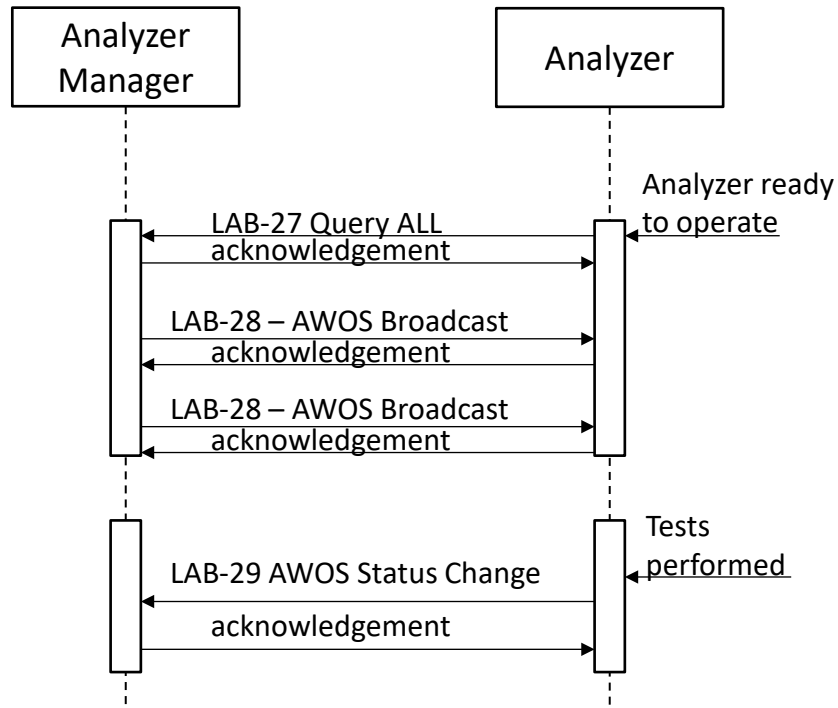

1170

Figure 5.4.2.2.2-1: Query ALL Process Flow in LAW Profile

5.4.2.3 Use Case #3: AWOS Query

In this use case, the process is triggered by the recognition of a specimen container by the Analyzer.

5.4.2.3.1 AWOS Query Use Case Description

1175

- a. The Analyzer recognizes a specimen container (by its barcode ID or position), and queries the Analyzer for the AWOSs scheduled on this specimen.
- b. These AWOSs are then broadcasted to the Analyzer, and the rest of the process is as in use case #1.

1180

The major difference with use case #1 is that instead of being transferred ahead of specimen arrival, the AWOS is transferred to the Analyzer just in time, and then performed without delay. Compared to use case#1, this use case minimizes the needs for further AWOS update or cancellation.

Exception handling:

1185

- v. The specimen may be placed on the Analyzer, before the Work Order has been received by the Analyzer Manager, and before the AWOS exists. In that case the query is unsuccessful. The answer sent in step b) will be “unknown specimen, no pending AWOS

for it”, which is also known as a Negative Query Response. Several events may occur depending upon the Analyzer’s capabilities and operator’s actions:

- 1190 1. The Analyzer skips this specimen.
2. The Analyzer suspends processing of the specimen and tries the query later.
3. The AWOS is created at the Analyzer (transition to use case 5.4.2.4).

Note: If multiple Analyzers can query for the same specimen and perform the same AWOS, then the AWOS should not be automatically created at the Analyzer. A Negative Query Response may have been received because another Analyzer queried for the specimen (see exception step c below).

1195 w. In this use case, the AWOS to be performed on the Analyzer is sent by the Analyzer Manager just in time, when the Analyzer is ready to perform it on the specimen. Thus, all updates to the AWOS occur on the Analyzer Manager and there is no need to cancel an AWOS that has been transferred to an Analyzer.

1200 x. Another Analyzer may have already queried for the same specimen. In this situation, any AWOS already sent to another Analyzer and accepted by that Analyzer will not be sent. If there are no AWOS to send, then the query is unsuccessful as all AWOS have been assigned to other Analyzers. The response sent in step b) will be “unknown specimen, no pending AWOS for it”, which is also known as a Negative Query Response. The Analyzer skips the specimen upon receiving a Negative Query Response.

1205 y. In the case where the AWOS is rejected by the Analyzer, it is up to the Analyzer Manager to determine the next steps for that AWOS. Possible actions include:

1. Send the AWOS to another Analyzer.
2. Ask the operator to manually process the AWOS.
3. Notify the operator that the AWOS could not be performed.

1210 **5.4.2.3.2 AWOS Query Use Case Process Flow**

Figure 5.4.2.3.2-1: AWOS Query Process Flow in LAW Profile

5.4.2.4 Use Case #4: AWOS Created On Analyzer

1215 This use case covers situations where the AWOS is created locally on the Analyzer, instead of being received from the Analyzer Manager.

5.4.2.4.1 AWOS Created On Analyzer Use Case Description

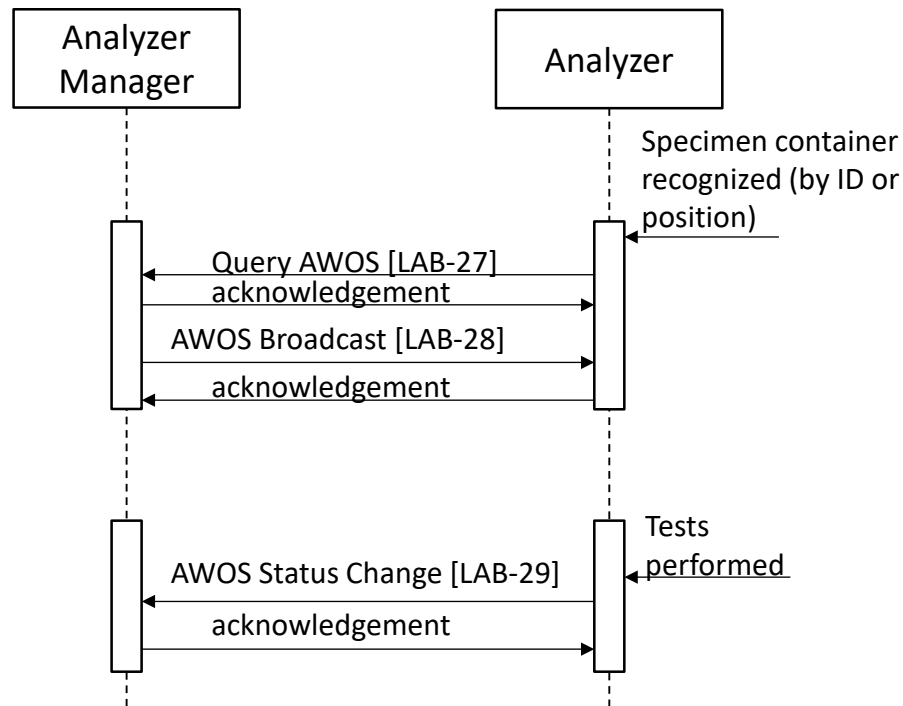
This use case covers normal situations as well as some of the exception handling of use cases #1, #2 and #3.

- 1220 a. The AWOS for a specimen is created locally in one of these situations:
- The Analyzer performs a single test (e.g., HbA1c) or a constant panel (Blood culture, Blood cells count...) and has a unidirectional interface.
 - A laboratory technical staff manually selects the tests to be performed on this specimen, having collected this information from upstream.
- 1225
- The Analyzer automatically associates a default test or panel to the specimen because the AWOS cannot be obtained from the Analyzer Manager, and this is the chosen way to handle this exception.

- 1230 In both cases the AWOS ID shall have a NULL value, because an AWOS ID can only be assigned by the Analyzer Manager.
 The Analyzer performs the AWOS on that specimen, and then, sends the results to the Analyzer Manager.
- 1235 b. The Analyzer Manager can handle these test results associated with a NULL AWOS ID, in various ways:
- Use specimen and test information to attach the results to the appropriate Work Order.
 - Ask the operator to manually link these orphan results to an existing Work Order.
 - Ignore and discard these results.

5.4.2.4.2 AWOS Created On Analyzer Use Case Process Flow

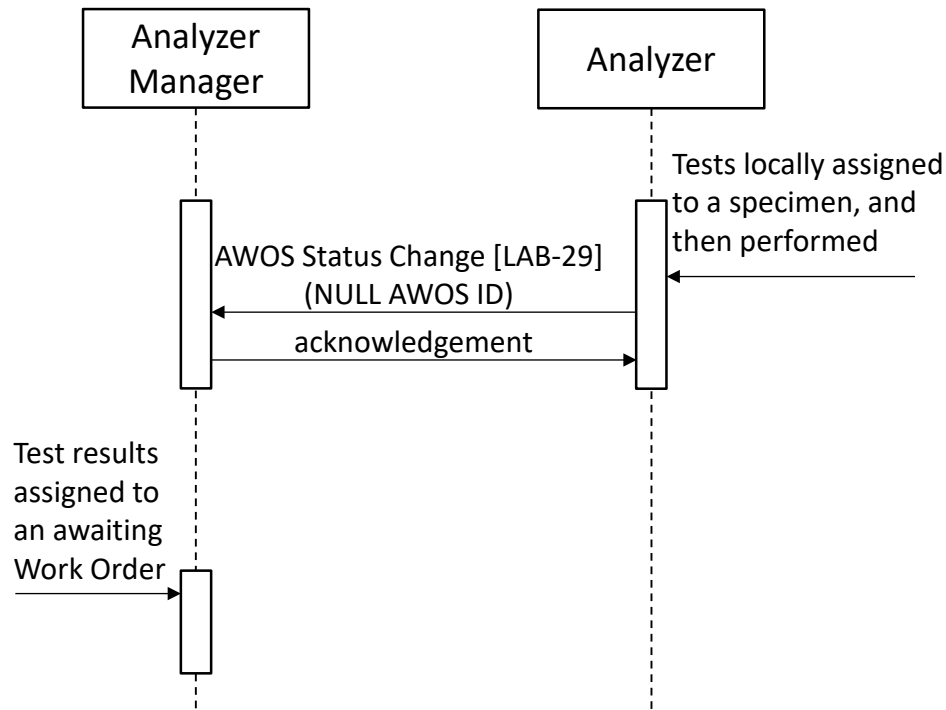

1240

Figure 5.4.2.4.2-1: AWOS Created on Analyzer Process Flow in LAW Profile

5.4.2.5 Use Case #5: Rerun Decided On Analyzer

1245 An AWOS usually needs one analytical run on the Analyzer. In some circumstances the results obtained from this first run need to be controlled by subsequent runs or “reruns”. When the Analyzer has decided (automatically or manually) to perform multiple runs for a test, it may send

the results of the successive runs in one or more messages. The selection of the reportable result among several runs can be determined:

- On the analyzer side. In that case, two situations are possible:
 - 1250 • The Analyzer reports only the results of the selected run to the Analyzer Manager. In that case, the rerun is transparent.
 - 1255 • The Analyzer reports the results from all runs to the Analyzer Manager, distinguishing each of them, in order to track the Analyzer operations and to register the reagent consumption. In that case the Analyzer identifies the selected run using the "result status" field to express that this one is the final (potentially corrected) result.
- On the Analyzer Manager side. In that case, the Analyzer reports the results of all runs with the same "result status", distinguishing each run. The Analyzer Manager selects which results to report.

1260 **5.4.2.5.1 Rerun Decided On Analyzer Use Case Description**

- a. The Analyzer performs the AWOS on a specimen (first run).
 - b. Based on the results obtained, the Analyzer schedules an additional run. The Analyzer may notify the Analyzer Manager of the results with a "preliminary" status for the first run for this AWOS, or may retain them until the additional run is performed.
 - 1265 c. The Analyzer performs the additional run.
 - d. The Analyzer notifies the Analyzer Manager, with the results and status of the additional run, or of all runs if they were not yet reported. All runs are assigned the same AWOS ID but are distinguished from one another by a run sequence number. An Analyzer may identify a final result of a run that is the best candidate to be reported to the ordering provider, or the Analyzer may let the Analyzer Manager select which results to report.
- 1270

5.4.2.5.2 Rerun Decided On Analyzer Use Case Process Flow

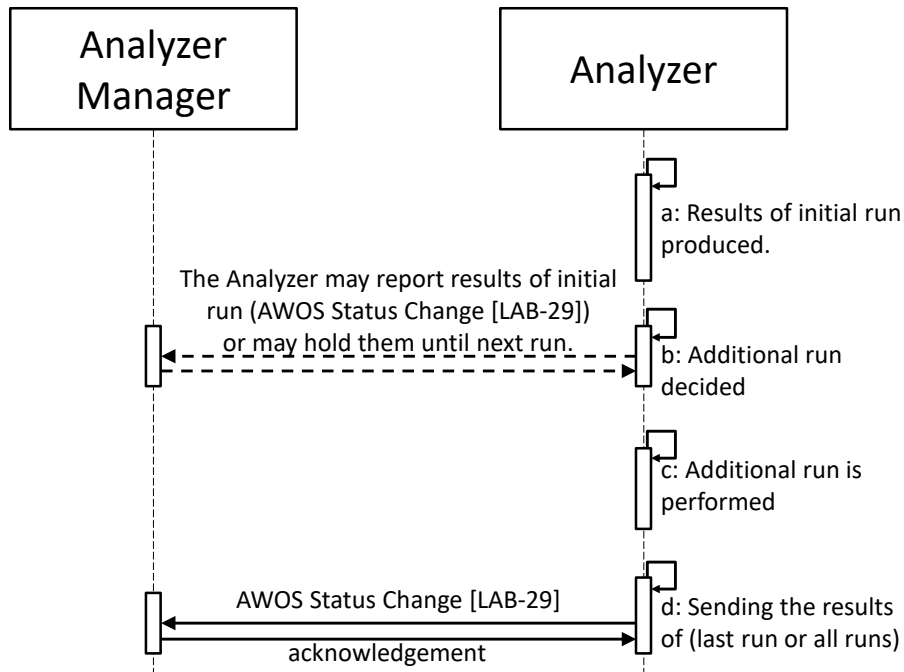

Figure 5.4.2.5.2-1: Rerun Decided on Analyzer Process Flow in LAW Profile

1275 **5.4.2.6 Use Case #6: Rerun Requested by Analyzer Manager**

A new run can be decided on the Analyzer Manager (automatically or by a laboratory staff) during the technical validation of the results of the previous run(s). The new run may also have been requested by the clinical pathologist as a new Work Order transferred to the Analyzer Manager. In all cases, the request for a new run is sent to the Analyzer as a new AWOS with a new AWOS ID, distinct from the one of the previous run. The process of this new AWOS is handled as in use cases #1, #2 or #3.

1280

5.4.2.7 Use Case #7: Reflex Decided on the Analyzer

In some circumstances the test results associated with one or more AWOS for a patient may trigger the execution/computation of one or more additional tests known as reflex tests.

1285 **5.4.2.7.1 Reflex Decided On Analyzer Use Case Description**

- a. The Analyzer performs one or more AWOSs.
- b. Considering the results obtained, a reflex test is scheduled. The Analyzer may send the results of the AWOSs now or as part of step d).

- 1290 c. The Analyzer performs the reflex test (on the current specimen or possibly on another specimen made available). The reflex test is performed as a child AWOS of the original AWOSs, and this child AWOS has a NULL AWOS ID.
- d. The Analyzer notifies the Analyzer Manager with the results and status of the parent AWOS(s) (if not sent previously) and reflex test with all known information (patient, specimen, container, test, and AWOS ID(s) of the parent(s)).
- 1295 e. On receiving an unexpected analytical tests result due to a reflex, the Analyzer Manager can handle them in different ways:
- link the result to the Work Order of the parent AWOS(s);
 - use specimen and test information to link the results to an appropriate Work Order;
 - 1300 • if supported by the Analyzer, use Work Order identification information sent by the Analyzer to link the result to a Work Order;
 - ask the operator to manually link these orphan results to AWOS.

5.4.2.7.2 Reflex Decided On Analyzer Use Case Process Flow

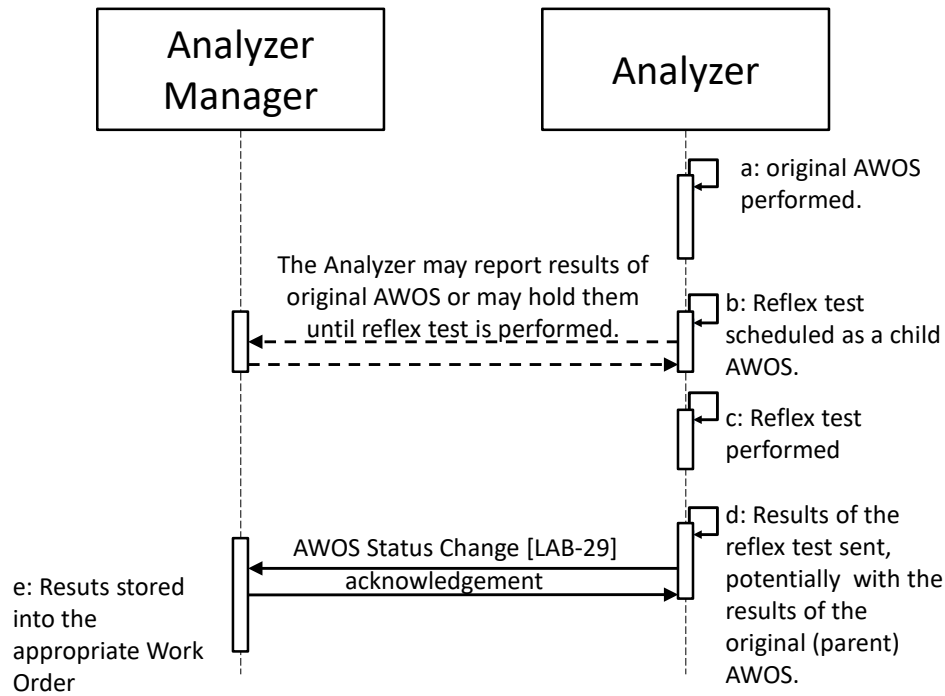

Figure 5.4.2.7.2-1: Reflex Decided on Analyzer Process Flow in LAW Profile

1305

5.4.2.8 Use Case #8: Reflex Requested by Analyzer Manager

1310 A reflex test can be decided on the Analyzer Manager (automatically or by a laboratory staff) during the technical validation of the results of one or more AWOSs. The reflex test may also have been requested by the clinical pathologist as a new Work Order transferred to the Analyzer Manager. In all cases, the request for this reflex test is sent to the Analyzer as a new AWOS with a new AWOS ID. The process of this new AWOS is handled as in use cases #1, #2 or #3.

5.4.2.9 Use Case #9: QC Specimen

1315 An AWOS can be attached to a quality control (QC) specimen. Use cases #1 to #8 cover QC specimen as well as patient specimen, with no significant difference in the process flows. The role of the specimen (QC versus patient) is clearly stated in the messages transferring the AWOS and its results.

5.4.2.10 Use Case #10: Specimen Pooled by Analyzer

1320 Use cases #1 to #8 cover non-pooled specimen as well as pooled specimen. For some particular tests in some specialties the Analyzer may pool several patient specimens into one. This behavior is supported by the profile option “Pooling on Analyzer”

- When broadcasting an AWOS, the Analyzer Manager specifies the maximal size of the pool the given specimen may be combined into. If the specimen is not to be pooled, pool size is set to “1”.
- As soon as the count of collected poolable specimens reaches the maximal target pool size of at least one of them, or when other circumstances like specimen expiration times do not allow further waiting, the Analyzer creates the pool and performs the observation.
- It is not a failure if the Analyzer decides to not pool a given specimen.
- Independently from whether specimens were pooled or not, observation results sent by the Analyzer correspond to the original specimens and not to their pool. In other words, the relationship between AWOSs, specimens, and observation results remains unchanged.
- The only difference in observation result messages is that the Analyzer specifies the actual size of the pool where the given specimen was combined into. For specimens that were not pooled, a pool size “1” is returned.

5.4.2.11 Use Case #11: Specimen Pooled Outside of Analyzer

1335 Use cases #1 to #8 cover non-pooled specimen as well as pooled specimen. For some particular tests, the specimen transmitted to the Analyzer is mixture of several patient specimens. If the Analyzer returns a “negative” result, then all patient specimens of the pool are considered “negative”. If the Analyzer returns a “positive” result, all the patient specimens of the pool have to be tested individually.

1340 This use case is supported by the profile option “Pooling Outside of Analyzer”, which brings the following behavior:

- The ordering of pooled specimens assumes an Analyzer Manager capable of managing the specimen pool (e.g., by connection to a pooling device) and an Analyzer capable of measurement and calculation of the result for the pooled specimen.
- 1345
- Because the specimen is pooled (multiple patients), no patient demographic information is allowed with the AWOS.
 - When the Analyzer does not use information about the pooling, then the Analyzer manager should send the AWOS as a conventional patient sample.
 - When the Analyzer uses information about the pooling, the AWOS sent to the Analyzer should include the following information:
- 1350
- It is a pooled specimen.
 - The pool size, i.e., the number of specimens used for this specific sample. This information is used in the calculation of the result (the negative specimens generally "dilute" the result of positive specimens).
- 1355
- List of specimen IDs used in the pool (for informational purpose at the Analyzer).

5.4.2.12 Use Case #12: Handling External Results

Use cases #1 to #11 may also handle external results. The Analyzer has three mechanisms for returning the result data to the Analyzer Manager:

- embedding the results into the AWOS Status Change (completion) message ;
- 1360
- putting the results into temporary on-line storage and passing a pointer to the results in the AWOS Status Change message ;
 - putting the results into a persistent data repository and passing a pointer to the results in the AWOS Status Change message.

The two latter ones are supported by the profile option “External Result”

1365 In the case of temporary on-line storage, the Analyzer Manager is responsible for retrieving the results prior to the expiration of the (locally determined) validity period. The Analyzer, or the temporary storage system, is responsible for ensuring the data remains available during the validity period, and for recovering storage space as desired after the validity period.

1370 In the case of result storage to a persistent data repository, the Analyzer Manager does not need to retrieve the results, but can simply manage the pointer to the results. Any follow-on applications that require access to the result data will use the pointer. Note that the pointer may provide specialized access mechanisms that are suited to the target result data (e.g., a URI to a web-based imaging study navigation and display application; see for instance the IHE Radiology Invoke Image Display Profile).

1375 5.5 LAW Security Considerations

See Appendix A

5.6 LAW Cross Profile Considerations

LAW actors can be grouped in various combinations, to fit the choices of organization and system architectures that can be encountered inside laboratories, as shown in Figure 5.6-1.

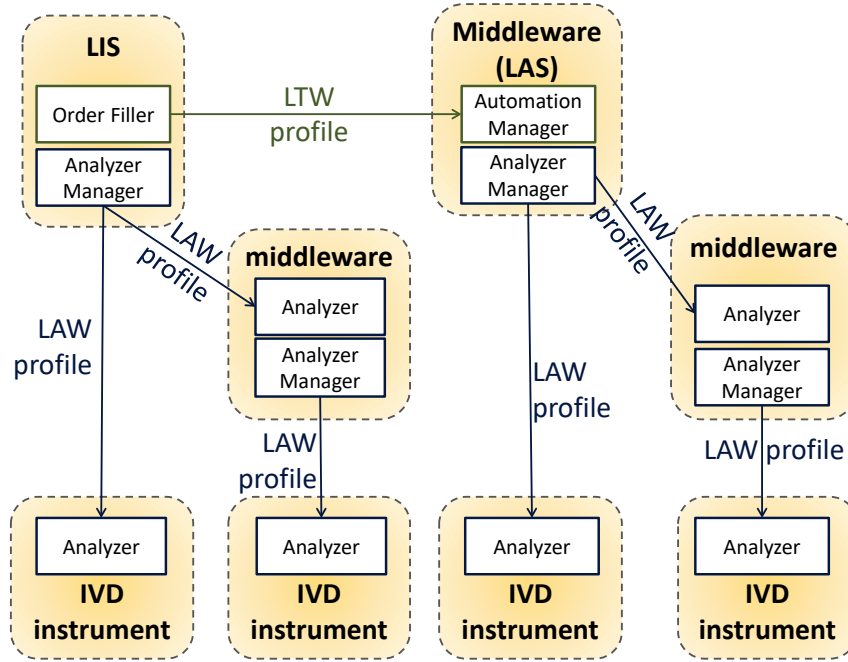

Figure 5.6-1: Actor groupings depending on system interconnections

1380

6 Laboratory Point Of Care Testing (LPOCT) Profile

1385 In some cases laboratory tests can be performed on the point of care or the patient's bedside by the ward staff. These organizations enable the ward staff immediate access to common tests, whose specimen does not need any pre-analytical preparation. The results are used immediately in clinical decisions.

The point of care analyzers located in the wards send their observations to a central point using a connection that can be persistent or intermittent.

1390 This profile addresses organizations, where point of care testing is placed under the supervision of a clinical laboratory of the healthcare enterprise. This supervision includes clinical validation of POCT results, Quality Control (QC) surveillance, reagent delivery, and education on good point of care testing practices delivered to the ward staff.

1395 This profile can also support organizations that leave point of care testing entirely under the responsibility of the ward medical staff using the point of care analyzers. These organizations will be referred as non-laboratory led organizations. (A subset of this profile will likely apply to these organizations.)

6.1 LPOCT Actors and Transactions

1400 This section defines the actors, transactions, and/or content modules in this profile. General definitions of actors are given in the Technical Frameworks General Introduction Appendix A published [here](#).

Figure 6.1-1 shows the actors directly involved in the LPOCT Profile and the relevant transactions between them.

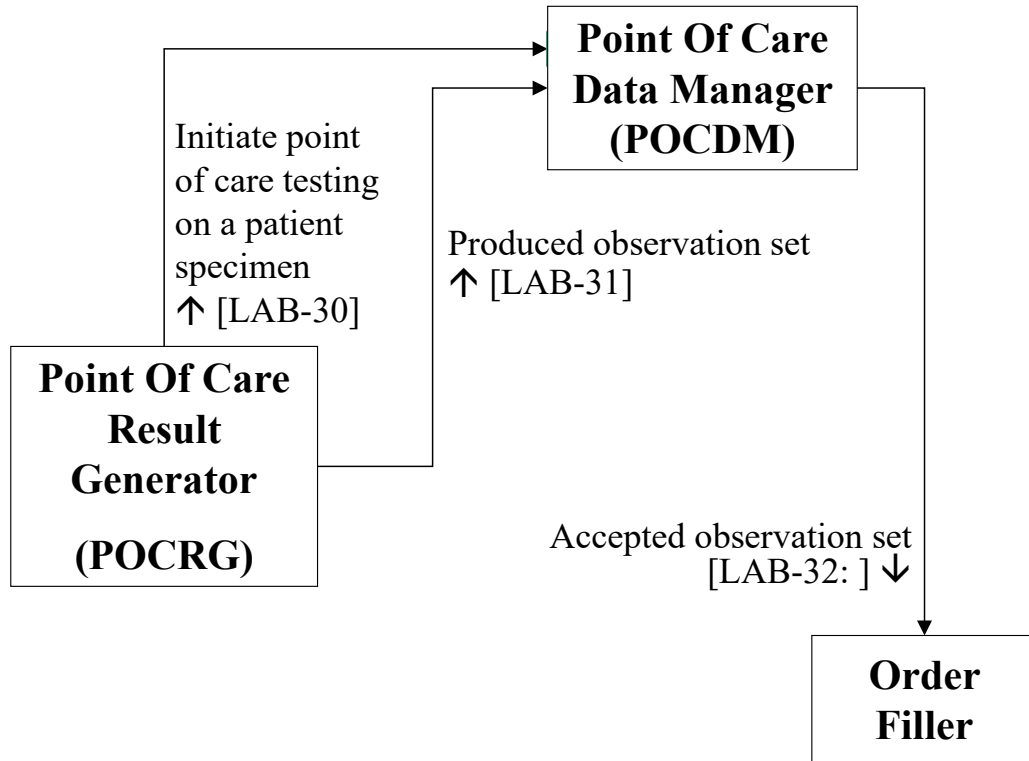

Figure 6.1-1: LPOCT Actor Diagram

1405

Table 6.1-1 lists the transactions for each actor directly involved in the LPOCT Profile. To claim compliance with this profile, an actor shall support all required transactions (labeled “R”) and may support the optional transactions (labeled “O”).

1410

Table 6.1-1: Laboratory Point Of Care Testing – Actors and Transactions

Actors	Transactions	Optionality	Section in Vol. 2
Order Filler	Accepted Observation Set [LAB-32]	R	PaLM TF-2c: 3.32
Point Of Care Data Manager	Initiate POCT on a patient specimen [LAB-30]	O ¹	PaLM TF-2c: 3.30
	Produced Observation Set [LAB-31]	R	PaLM TF-2c: 3.31
	Accepted Observation Set [LAB-32]	R	PaLM TF-2c: 3.32
Point Of Care Result Generator	Initiate POCT on a patient specimen [LAB-30]	O ¹	PaLM TF-2c: 3.30
	Produced Observation Set [LAB-31]	R	PaLM TF-2c: 3.31

Note 1: Initiate POCT on a patient specimen [LAB-30] is required for PCRGM and POCDM supporting the “patient identity checking” Option.

6.1.1 Actor Descriptions and Actor Profile Requirements

1415 Most requirements are documented in Transactions (Volume 2). This section documents any additional requirements on profile's actors.

6.2 LPOCT Actor Options

Options that may be selected for each actor in this profile are listed in the Table 6.2-1.

Table 6.2-1: Laboratory Point Of Care Testing - Actors and Options

Actor	Option Name	Reference
Order Filler	none	
Point Of Care Data Manager	Patient Identity Checking	PaLM TF-2c: 3.30
Point Of Care Result Generator	Patient Identity Checking	PaLM TF-2c: 3.30

1420

The Patient Identity Checking option represents transaction LAB-30.

6.2.1 Patient Identity Checking

1425 This option requires a persistent link between the point of care device implementing the POCRG and the central point of care data manager implementing the POCDM. In this situation, the POCRG and the POCDM use transaction LAB-30 to check the patient's identity, before performing the tests on a patient specimen, ensuring that the correct patient/visit ID has been entered (or scanned) on the point of care device.

6.3 LPOCT Required Actor Groupings

1430 An actor from this profile (Column 1) shall implement all of the required transactions and/or content modules in this profile *in addition to* all of the transactions required for the grouped actor (Column 2).

In some cases, required groupings are defined as at least one of an enumerated set of possible actors; this is designated by merging column one into a single cell spanning multiple potential grouped actors. Notes are used to highlight this situation.

1435 Section 6.5 describes some optional groupings that may be of interest for security considerations and Section 6.6 describes some optional groupings in other related profiles.

Table 6.3-1: Laboratory Point Of Care Testing - Required Actor Groupings

LPOCT Actor	Actor to be grouped with	Reference	Content Bindings Reference
Order Filler	PaLM LTW Order Filler	PaLM TF-1: 3	n.a.

LPOCT Actor	Actor to be grouped with	Reference	Content Bindings Reference
Point Of Care Data Manager (see Note 3)	ITI PAM Patient Demographics Consumer AND ITI PAM Patient Encounter Consumer	ITI TF-1: 14	n.a.
	ITI PDQ Patient Demographics Consumer	ITI TF-1: 8	n.a.
Point Of Care Result Generator	none	none	n.a.

Note 3: Point Of Care Data Manager SHALL be grouped with at least one of the combinations of actors listed in this row.

1440

6.4 LPOCT Overview

In scope of the Profile:

- Tests performed by care givers within a healthcare enterprise on the patient bedside or the point of care, or in home care under the control of a healthcare enterprise.
- 1445 • All specialties of laboratory medicine that can be performed on the point of care.
- Testing on in vitro specimen, not on patients themselves.
- Tests of short time execution that do not need any significant pre-analytical process.
- Observations produced by a point of care analyzer, or manually entered on a system, or calculated by a system.
- 1450 • Point of care devices with persistent or intermittent link to the central point of care data manager.
- Overall supervision of the point of care testing process, possibly including QC surveillance, reagent management, operator certification.

Out of scope of the Profile:

- 1455 • The remote control of the point of care testing devices by the central point of care data manager (remote commands).
- The identification process of the operators.
- The transmission of QC results from the POCDM to the Order Filler.
- Corrections or cancellations of point of care observations previously transmitted.

1460 **6.4.1 Concepts**

6.4.2 Use Cases

6.4.2.1 Use Case #1: Ordered

This use case involves a real-time patient identity checking. It requires a persistent link between the point of care testing device (POCRG) and the point of care data manager (POCDM).

1465 The scenario covers the situation in which the order for point of care testing is created on the Order Placer application of the LTW Profile, prior to the testing. The order number is not entered on the POCRG. The Order Filler has to match the existing order received via the LTW Profile.

6.4.2.1.1 Ordered Use Case Description

Part 1 of the scenario

1470 The physician orders point of care tests for a patient. This order is entered on the Order Placer application and is assigned a placer order number. As part of the LTW Profile, the Order Placer sends this new point of care order to the Order Filler, which assigns a Filler Order Number to it, and waits for point of care observations.

Part 2 of the scenario

1475 To fulfill this Order, the operator (physician, nurse, patient) collects a specimen from the patient and puts it on the point of care device. The operator initiates the operation, providing its own identification, a patient/visit identifier and all information relevant for testing. In addition the operator enters the indication that an order already exists for the tests to perform.

Part 3 of the scenario

1480 The POCRG notifies this information to the POCDM to check information provided, and to get the patient name. This patient name sent back to the point of care device is displayed so that the operator can check that he/she has entered the correct patient/visit identifier. If the patient is unknown to the POCDM or in other error cases, the operator will follow the enterprise policies.

Part 4 of the scenario

1485 The point of care device performs the tests on the specimen, produces the results and displays them to the user.

The POCRG sends the observation set with its related data to the POCDM, including the indication “existing order to be matched”.

1490 The POCDM checks the received observations against its own rules (result compared with normal ranges or scale limits, QC results obtained and correct ...), accepts them, stores them, and acknowledges them to the POCRG (results accepted). The POCRG displays the acknowledgment received from the POCDM. In case the POCDM detected an erroneous or suspicious result, it rejects the results, and sends back a negative acknowledgement to the POCRG.

1495 **Part 5 of the scenario: – order matched**

Having accepted the observation set, the POCDM forwards it to the Order Filler, accompanied by the indication “existing order to be matched”.

1500 The Order Filler searches for the existing order in its own data base, by matching a point of care testing order for the same patient, containing the same tests, and placed by the same ordering provider, at approximately the same time. It stores the received observation set into this order. If the Order Filler can’t match any existing order in its data base, it generates a new order as in use case 5.5.2.

The Order Filler acknowledges the observation set to the POCDM, sending in the acknowledgment message its filler order number.

1505 As part of the LTW Profile, the Order Filler notifies the Order Placer that the results for the POCT order have arrived (status change of the order).

Part 6 of the scenario: Clinical validation

1510 Later on, the clinical validation of the results is performed. In the LTW Profile, this triggers the sending of these results to the Order Result Tracker, and the notification “order completed” sent to the Order Placer.

6.4.2.1.2 Ordered Use Case Process Flow

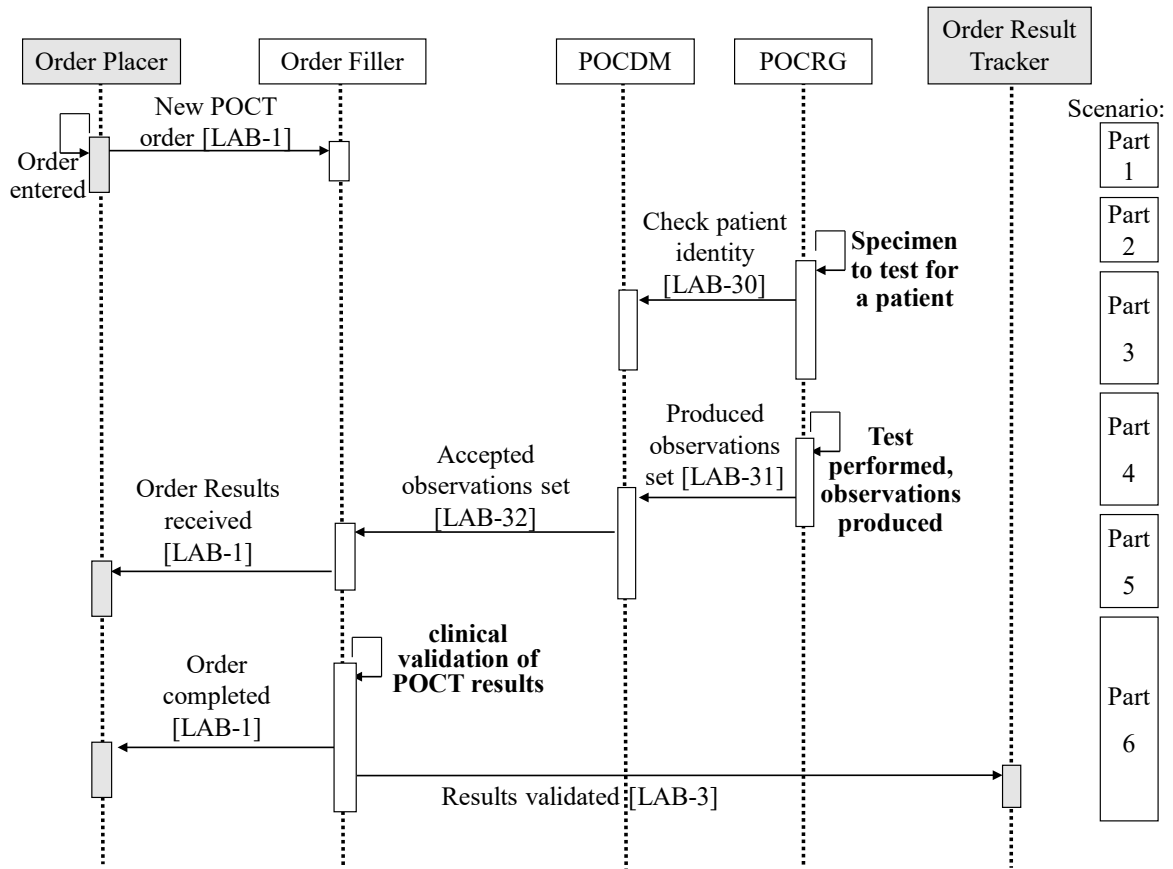

Figure 6.4.2.1.2-1: Ordered Process Flow in LPOCT Profile

1515 **6.4.2.2 Use Case #2: Unordered**

This use case involves a real-time patient identity checking. It requires a persistent link between the point of care testing device (POCRG) and the point of care data manager (POCDM). The tests are performed before the order is created. The order is created automatically by the Order Filler upon reception of the POCT observations.

1520 **6.4.2.2.1 Unordered Use Case Description**

Part 1 of the scenario

The operator (physician, nurse,) sets a patient specimen on the point of care device implementing a POCRG. The operator initiates the operation, providing its own identification, a patient identifier and all information relevant for testing.

1525 **Part 2 of the scenario: Patient identity checking**

Same as Part 3 of use case #1.

Part 3 of the scenario: test performed and observations collected by POCDM

Same as Part 4 of use case #1.

Part 4 of the scenario: supervision by a clinical laboratory – order generated

1530 Having accepted the POCT observation set, the POCDM forwards them to the Order Filler of the laboratory supervising the point of care testing process. The Order Filler stores the received results into a new filler order generated right away. The Order Filler acknowledges the observation set to the POCDM, sending in the acknowledgment message its assigned filler order number.

1535 Being also involved in LTW Profile, the Order Filler obtains a placer order number from the Order Placer, using transaction LAB-2. During this transaction, the Order Placer application creates a placer order for this point of care observation set, and sends back the placer order number assigned.

1540 In the case of an unknown patient, the reconciliation will be the task of the Order Filler application.

Part 5 of the scenario: Clinical validation

Same as Part 6 of use case #1.

6.4.2.2.2 Unordered Use Case Process Flow

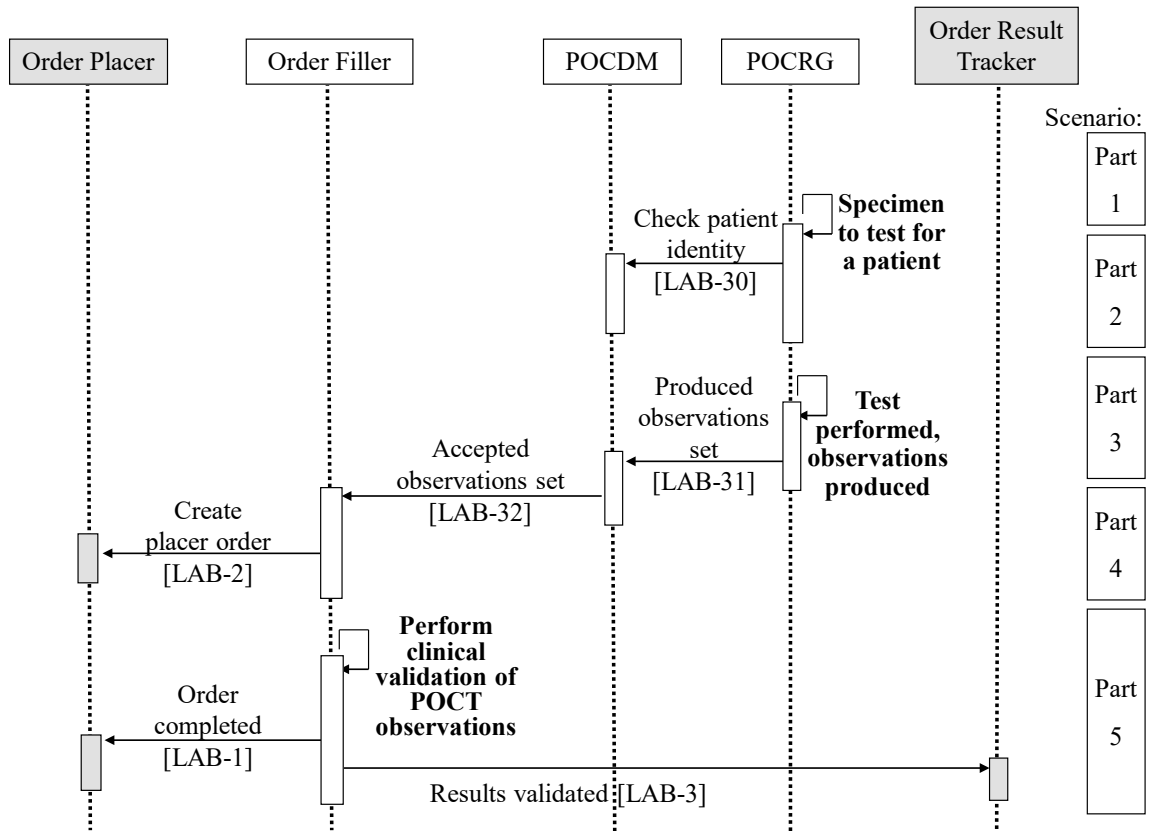

1545

Figure 6.4.2.2.2-1: Unordered Process Flow in LPOCT Profile

6.4.2.3 Use Case #3: Intermittent Link

This variant of use case #2, is met with POCT devices intermittently connected to the healthcare enterprise’s network. In such a configuration, the tests are performed offline without real-time patient identity checking.

1550

6.4.2.3.1 Intermittent Link Use Case Description

Part 1 of the scenario

Same as Part 1 of use case #2.

Part 2 of the scenario

1555

The POCRG performs the tests on the specimen, produces the results, qualifies them against its own rules (such as normal ranges) displays them, and stores them in its memory.

Part 3 of the scenario

1560 Later on, when a connection is established with the POCDM (e.g., when the point of care device is plugged on its docking station), the POCRG sends all the POCT observations accumulated in its memory.

The POCDM receives the observation sets, checks their information, including patient IDs, stores them, and acknowledges them to the POCRG.

The POCRG displays the acknowledgment received from the POCDM.

Part 4 and 5 of the scenario identical to parts 4 and 5 of use case #2

1565 **6.4.2.3.2 Intermittent Link Use Case Process Flow**

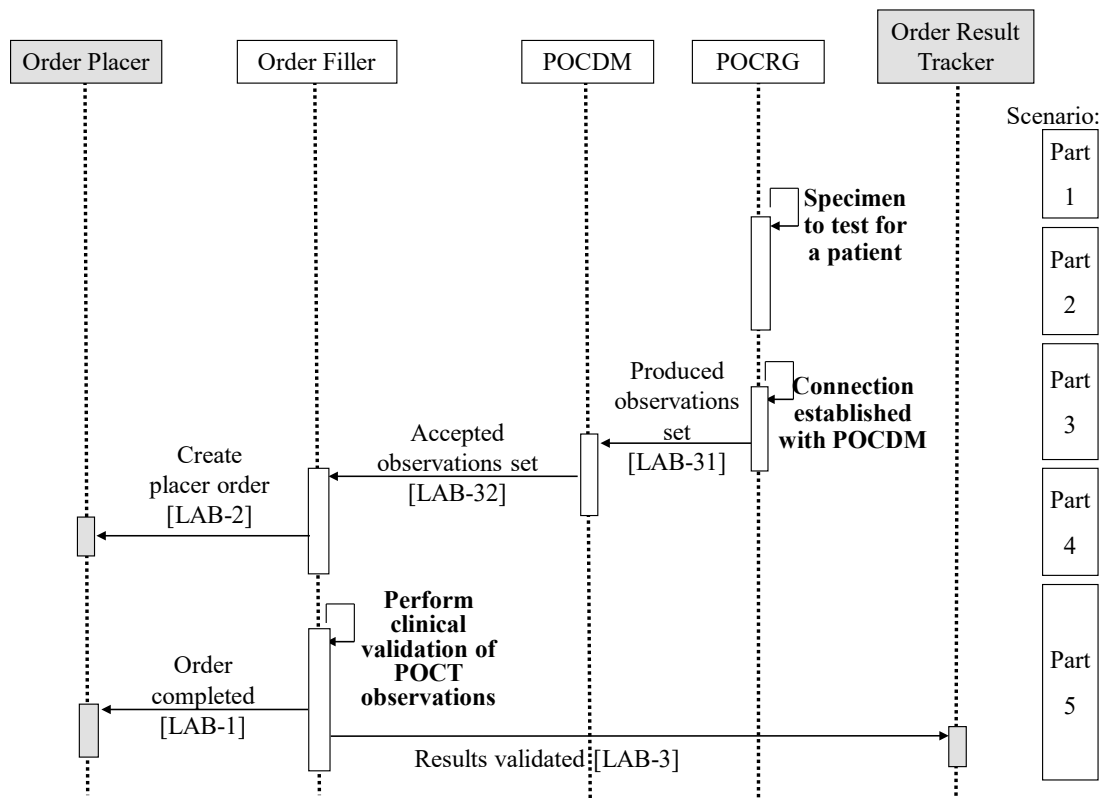

Figure 6.4.2.3.2-1: Intermittent Link Process Flow in LPOCT Profile

6.4.2.4 Use Case #4: Manual Entry

1570 Some point of care observations are read and entered manually (e.g., urine sticks). This scenario is met when such POCT observations are entered manually directly on the central POCT system, which in this case, groups the POCDM and POCRG Actors.

6.4.2.4.1 Manual Entry Use Case Description

Part 1 of the scenario

1575 The nurse identifies herself on the POCRG (grouped with POCDM) and enters the patient ID.
 The POCRG grouped with POCDM checks this patient ID and displays the patient full identity, and visit information, enabling the operator to verify the patient’s identity.

The operator enters the observations on the POCRG. The POCDM controls the observation set against its configuration rules, rejects them or accepts them, and stores them in the latter case.

1580 Part 2 and 3 of the scenario

Same as part 4 and 5 of use cases #1 and #2.

6.4.2.4.2 Manual Entry Use Case Process Flow

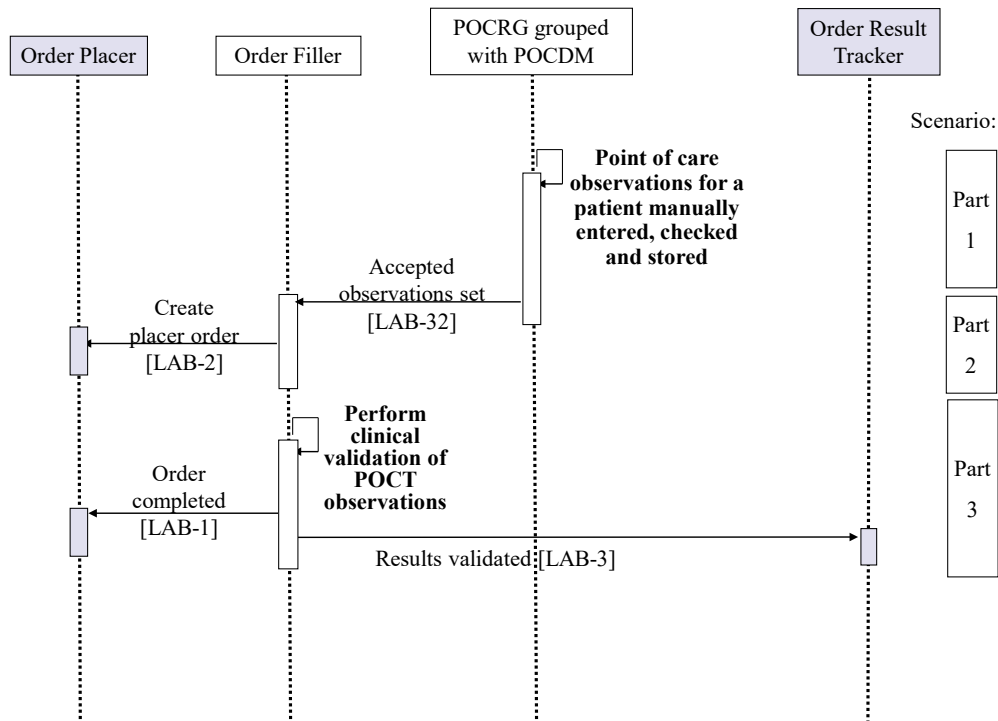

Figure 6.4.2.4.2-1: Manual Entry Process Flow in LPOCT Profile

1585

6.4.2.5 Use Case #5: QC

Quality Control (QC) tests are monitored by the POCDM.

6.4.2.5.1 Use Case Description

Part 1 of the scenario

1590 The operator initiates the operation by identifying himself (or herself) to the POCRG, entering (or scanning) the QC specimen ID.

The operator enters additional information required, such as specimen type, reagent lot number, tests to be performed.

Part 2 of the scenario

1595 The POCRG performs the tests on the QC specimen and produces the results.

At once if the POCRG has a persistent connection, or when the next connection with POCDM is established, the POCRG sends the set of QC observations to the POCDM.

The POCDM receives the set of observations, verifies it against its configuration rules, stores it, and acknowledges it to the POCRG.

1600 If the QC results fail verification the POCDM and POCRG might hide the results, just displaying “QC failed”, and block further process from this device on patient specimens until the operator perform the corrective action, and start again the QC test.

6.4.2.5.2 Use Case Process Flow

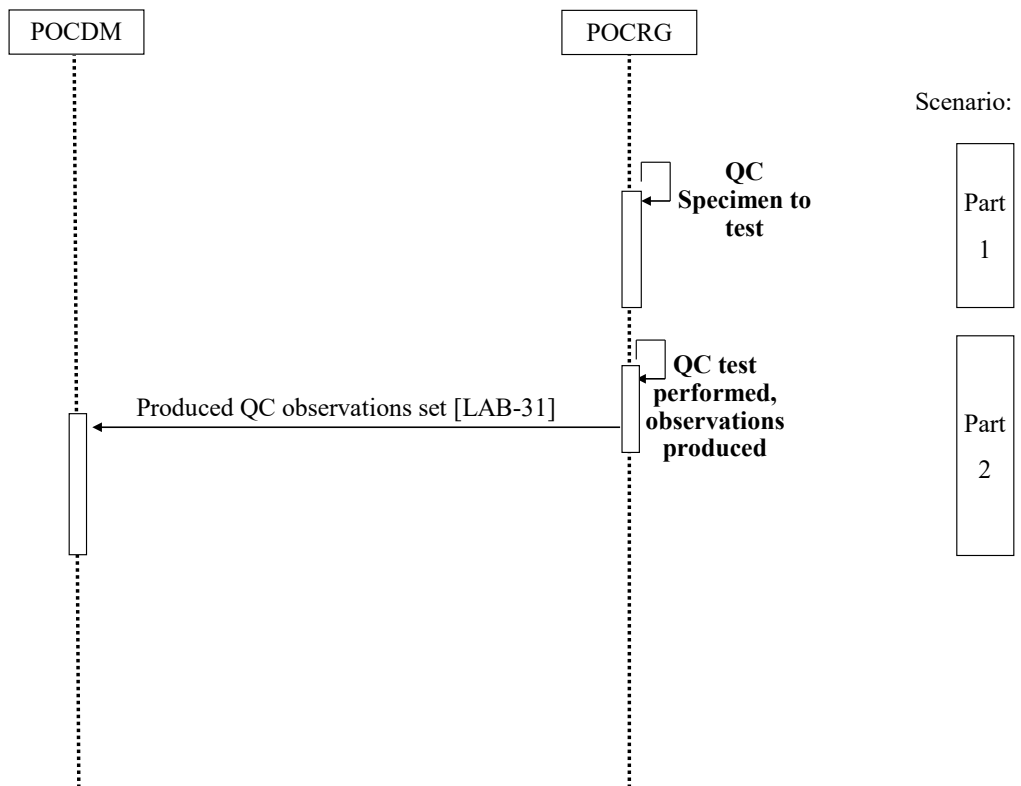

1605

Figure 6.4.2.5.2-1: Process Flow in LPOCT Profile

6.5 LPOCT Security Considerations

See Appendix A

6.6 LPOCT Cross Profile Considerations

1610 The POCDM might be grouped with the POCRG to support use case #4 “Manual Entry” described above.

7 Laboratory Specimen Barcode Labeling (LBL) Profile

1615 The Laboratory Barcode Labeling Integration Profile enables a robotic system to deliver specimen containers pre-identified with a bar coded label, for the specimen collection related to a laboratory test order. This robotic system receives patient, test order and specimen data from another system (HIS, CIS, LIS), and issues a label for each specimen container needed, with the specimen identifier bar coded on the label, and possibly other information printed on this label.

This profile addresses only specimen container labeling within the scope of the Pathology and Laboratory Medicine domain. It does not address labeling workflows in other domains.

7.1 LBL Actors and Transactions

1620 This section defines the actors, transactions, and/or content modules in this profile. General definitions of actors are given in the Technical Frameworks General Introduction Appendix A published [here](#).

Figure 7.1-1 shows the actors directly involved in the LBL Profile and the relevant transactions between them.

1625

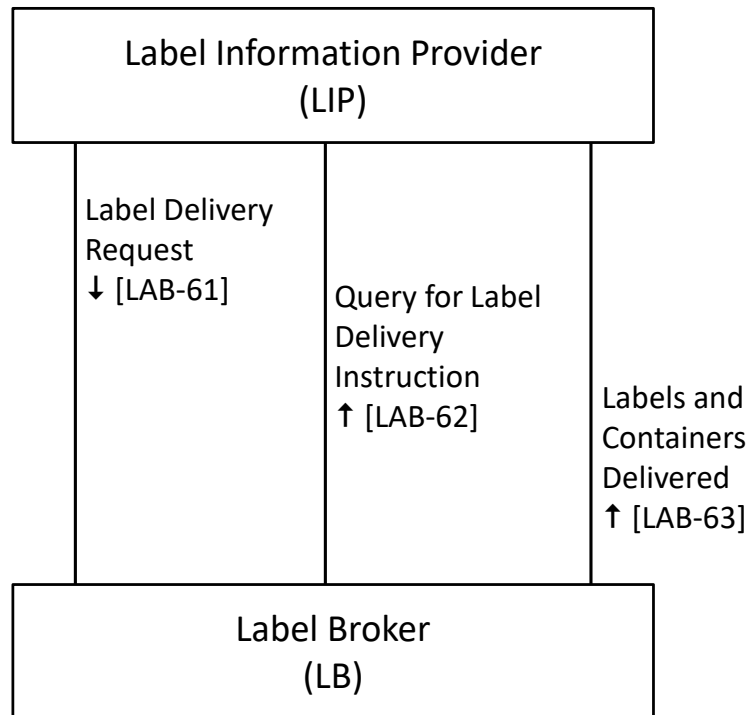

Figure 7.1-1: LBL Actor Diagram

1630 Table 7.1-1 lists the transactions for each actor directly involved in the LBL Profile. To claim compliance with this Profile, an actor shall support all required transactions (labeled “R”) and may support the optional transactions (labeled “O”).

Table 7.1-1: Laboratory Specimen Barcode Labeling – Actors and Transactions

Actors	Transactions	Optionality	Section in Vol. 2
Label Information Provider (LIP)	Label Delivery Request [LAB-61]	R	PaLM TF-2c: 3.44
	Query for Label Delivery Instruction [LAB-62]	R	PaLM TF-2c: 3.45
	Labels and Containers Delivered [LAB-63]	O ¹	PaLM TF-2c: 3.46
Label Broker (LB)	Label Delivery Request [LAB-61]	R	PaLM TF-2c: 3.44
	Query for Label Delivery Instruction [LAB-62]	O ²	PaLM TF-2c: 3.45
	Labels and Containers Delivered [LAB-63]	O ¹	PaLM TF-2c: 3.46

1635 Note 1: Labels and Containers Delivered [LAB-63] is required for LIP and LB Actors supporting the “labels and containers delivered” Option.

Note 2: Query for Label Delivery Instruction [LAB-62] is required for LB Actors supporting the “query for labeling instructions” Option.

7.1.1 Actor Descriptions and Actor Profile Requirements

1640 Most requirements are documented in Transactions (Volume 2). This section documents any additional requirements on profile’s actors.

7.2 LBL Actor Options

Options that may be selected for each actor in this profile are listed in the Table 7.2-1.

1645 **Table 7.2-1: Laboratory Specimen Barcode Labeling - Actors and Options**

Actor	Option Name	Reference
Label Information Provider	Labels and Containers Delivered	PaLM TF-2c: 3.46
Label Broker	Query for labeling instruction	PaLM TF-2c: 3.45
	Labels and containers delivered	PaLM TF-2c: 3.46

7.2.1 Query for labeling instruction

1650 This option represents the capability of the Label Broker to query the Label Information Provider for labeling instructions related to a test order for a patient. Transaction LAB-62 is used for this purpose.

7.2.2 Labels and containers delivered

This option represents the capability of both actors of the Profile, to support the event “the labels and containers for a test order have been delivered”. LB notifies this event, and LIP captures it. Transaction LAB-63 is dedicated to the communication of this event.

1655 **7.3 LBL Required Actor Groupings**

An actor from this profile (Column 1) shall implement all of the required transactions and/or content modules in this profile *in addition to* all of the transactions required for the grouped actor (Column 2).

1660 In some cases, required groupings are defined as at least one of an enumerated set of possible actors; this is designated by merging column one into a single cell spanning multiple potential grouped actors. Notes are used to highlight this situation.

Section 7.5 describes some optional groupings that may be of interest for security considerations and Section 7.6 describes some optional groupings in other related profiles.

1665 **Table 7.3-1: Laboratory Specimen Barcode Labeling - Required Actor Groupings**

LBL Actor	Actor to be grouped with	Reference	Content Bindings Reference
LIP	PaLM LTW Order Filler OR PaLM LTW Order Placer	PaLM TF-1: 3	n.a.

7.4 LBL Overview

7.4.1 Concepts

1670 The LIP is the system that has the knowledge of what specimens, containers and labels are needed to perform a particular test order for a patient. The LB is the system that can deliver the labels and containers, and possibly apply the labels to the containers.

The delivery of labels and containers needed for a particular test order can happen in two modes:

- Request: The LIP takes the lead and requests the LB to deliver labels and containers corresponding to a test order for a patient.
 - Query: The LB takes the lead and queries for labeling and delivery instructions related to a patient test order. This query may be triggered for example, by the arrival of the patient at blood collection room.
- 1675

7.4.2 Use Cases

7.4.2.1 Use Case #1: Placer Requesting

1680 The Label Information Provider is grouped with the Order Placer of the LTW Profile. It determines the specimens and containers needed for a test order it has placed in the LTW Profile, and sends the corresponding label delivery request to the Label Broker in the LBL Profile.

This use cases includes the option “labels and containers delivered “.

7.4.2.1.1 Placer Requesting Use Case Description

- 1685
- a) The Order Placer generates a test order and calculates the needed containers and associated barcode labels for this order.
 - b) The Order Placer places the order to the Order Filler, and the Order Filler accepts it.
 - c) In due time, the Label Information Provider sends the labeling instructions to the Label Broker.
 - 1690 d) The Label Broker issues the containers with barcode labels. At the end of the process, the Label Broker notifies the Label Information Provider of successfully labeled containers.
 - e) The labeled containers are then used for specimen collection and then sent to the laboratory for testing.

7.4.2.1.2 Placer Requesting Use Case Process Flow

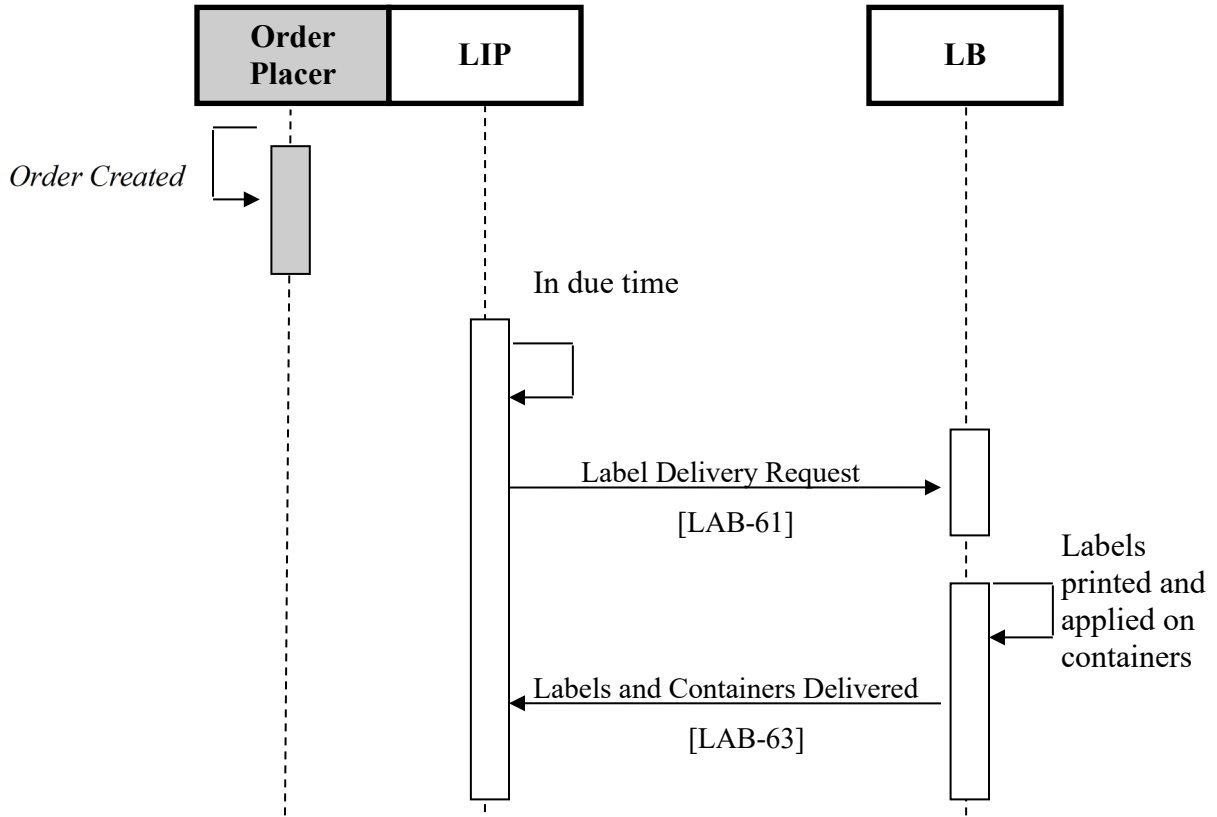

1695

Figure 7.4.2.1.2-1: Placer Requesting Process Flow in LBL Profile

7.4.2.2 Use Case #2: Placer Queried

1700 The Label Information Provider is grouped with the Order Placer of the LTW Profile. It determines the specimens and containers needed for a test order it has placed in the LTW Profile. The Label Broker queries the Label Information Provider to obtain the labeling and container delivery instructions related to the test order.

This use cases includes the option “labels and containers delivered “.

1705 **7.4.2.2.1 Placer Queried Use Case Description**

- a) A test order is placed.
- b) The patient arrives at the specimen collection point. The patient id is entered (scanned) into the Label Broker. This triggers a query from the Label Broker to the Label Information Provider to obtain labeling instructions for the specimens to be collected from this patient.
- c) The Label Information Provider grouped with the Order Placer responds with the labeling instructions.

1710

- 1715
- d) The Label Broker issues the containers with barcode labels. At the end of the process the Label Broker may notifies the Label Information Provider of successful delivery of labeled containers.
 - e) The labeled containers are used for specimen collection and then sent to the laboratory for testing.

7.4.2.2.2 Placer Queried Use Case Process Flow

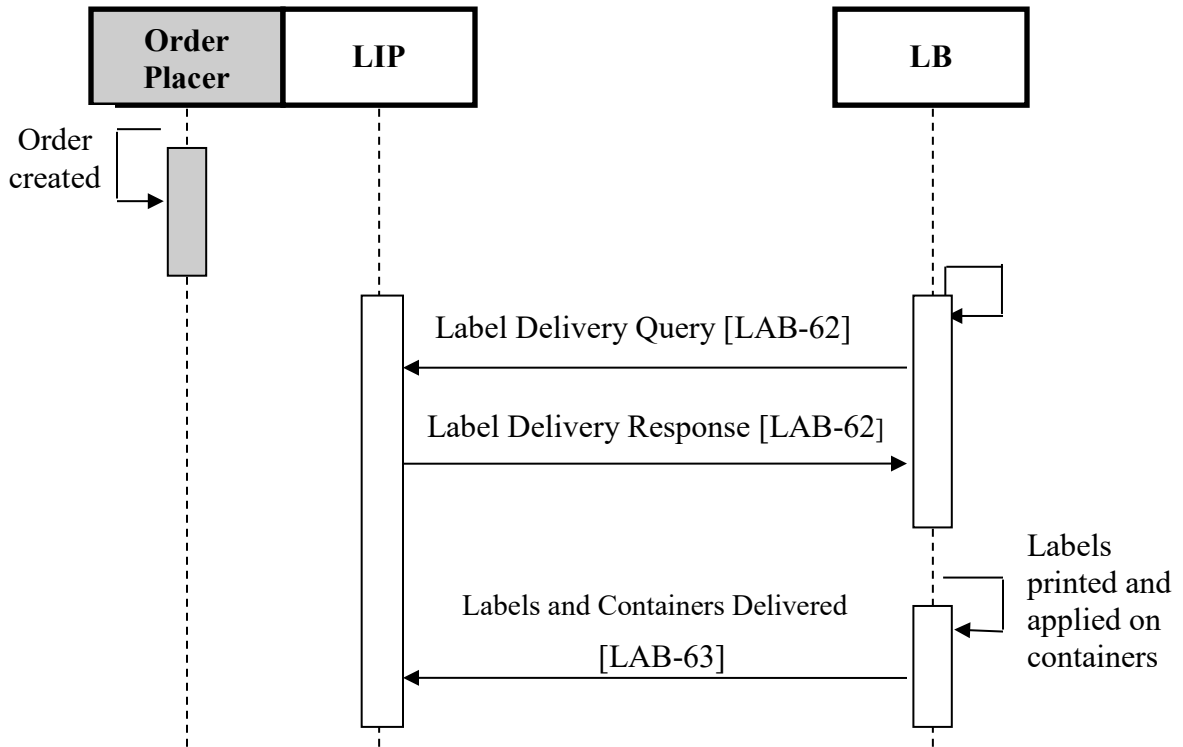

1720 **Figure 7.4.2.2.2-1: Placer Queried Process Flow in LBL Profile**

7.4.2.3 Use Case #3: Filler Requesting

1725 The Label Information Provider is grouped with the Order Filler of the LTW Profile. It determines the specimens and containers needed for a test order it has received in the LTW Profile, and sends the corresponding label delivery request to the Label Broker in the LBL Profile.

This use cases includes the option “labels and containers delivered “.

7.4.2.3.1 Filler Requesting Use Case Description

- 1730
- a) The Order Filler receives a test order from the Order Placer.
 - b) The Order Filler calculates the needed containers and associated barcode labels for this order. Then the LIP sends the labeling instructions to the LB.

- c) The LB issues the containers with barcode labels and notifies the LIP with the successful end of the process.

7.4.2.3.2 Filler Requesting Use Case Process Flow

1735

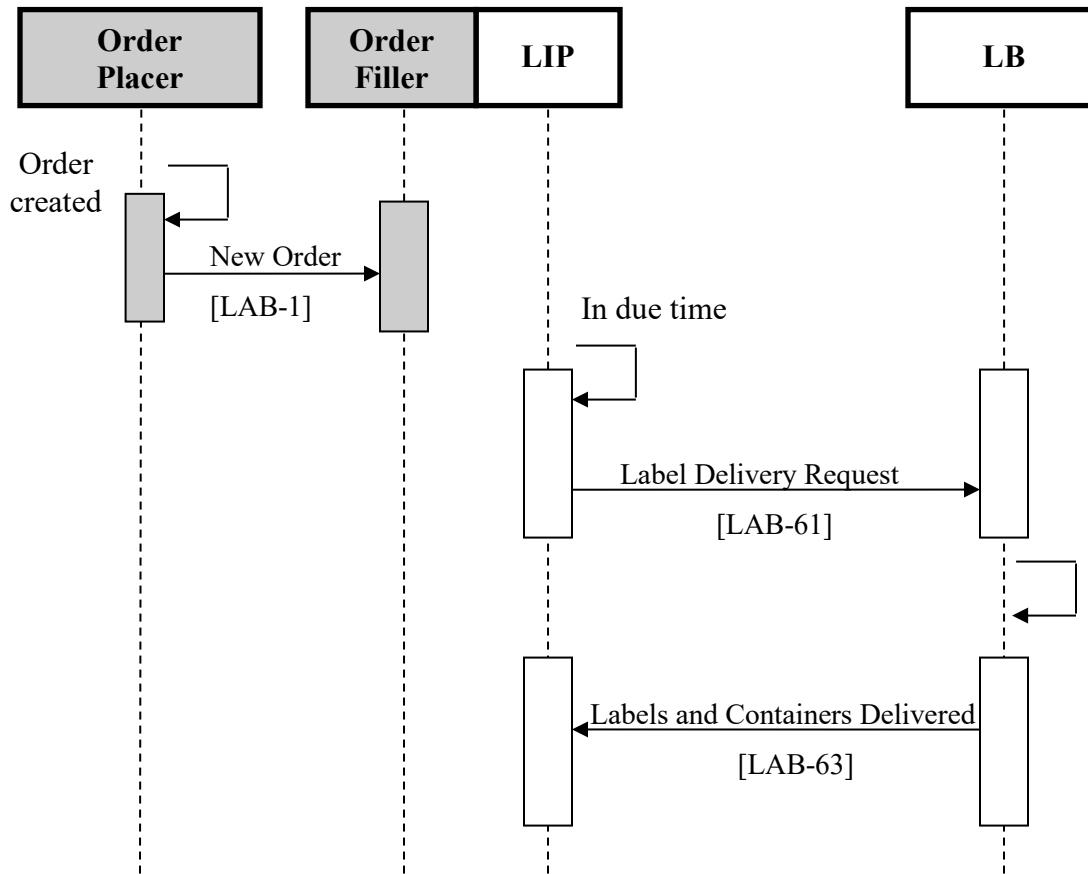

Figure 7.4.2.3.2-1: Filler Requesting Process Flow in LBL Profile

7.4.2.4 Use Case #4: Filler Queried

1740

The Label Information Provider is grouped with the Order Filler of the LTW Profile. It determines the specimens and containers needed for a test order it has received in the LTW Profile. The LB queries the LIP to obtain the labeling instructions.

This use cases includes the option “labels and containers delivered”.

7.4.2.4.1 Filler Queried Use Case Description

1745

- a) The Order Filler receives a test order from the Order Placer.

- 1750
- b) The Order Filler calculates the needed containers and associated barcode labels for this order.
 - c) The patient arrives at the specimen collection point. The patient id is entered into the Label Broker. This triggers a query from the Label Broker to the Label Information Provider to get labeling instructions for the specimens to be collected from this patient.
 - d) The LB issues the containers with barcode labels and notifies the LIP with the successful end of the process.

7.4.2.4.2 Filler Queried Use Case Process Flow

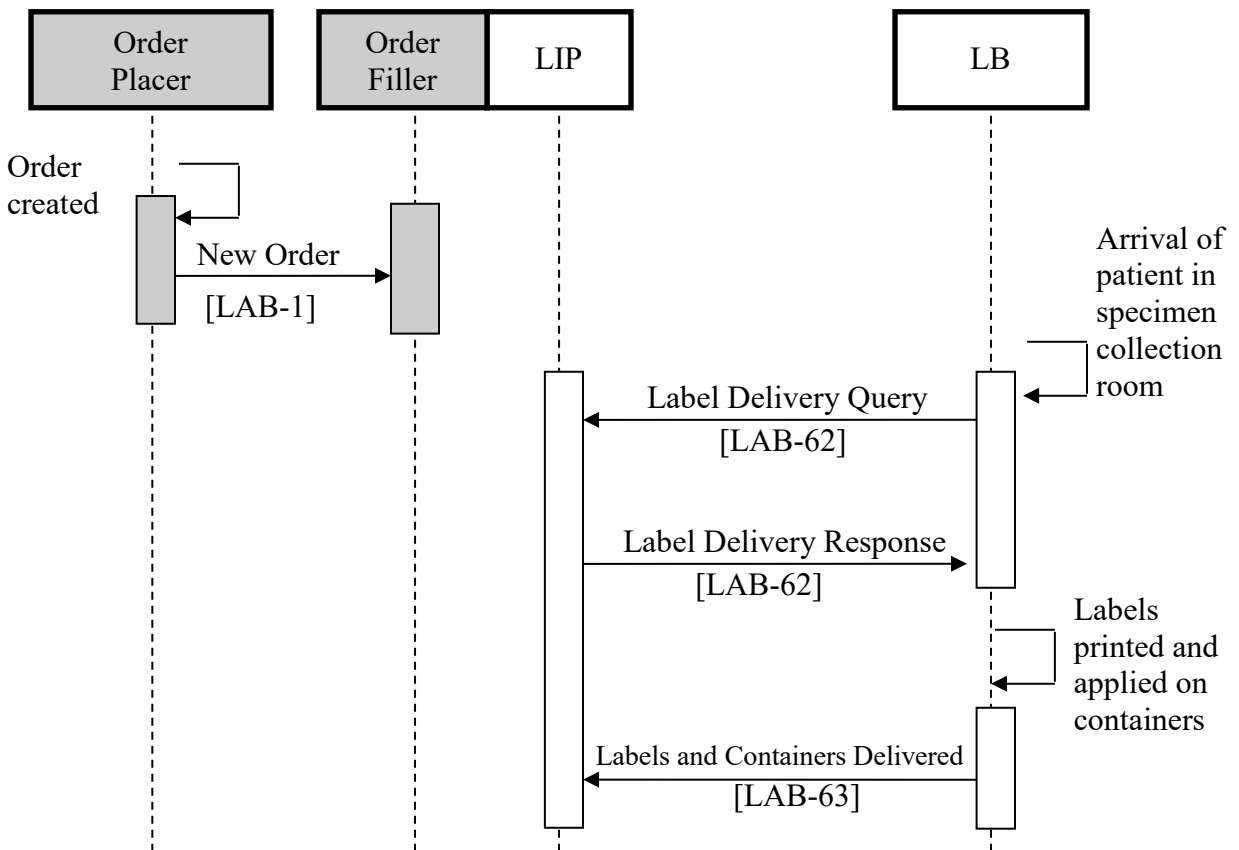

1755 **Figure 7.4.2.4.2-1: Filler Queried Process Flow in LBL Profile**

7.4.2.5 Use Case #5: Placer Queries Filler

The Label Information Provider is grouped with the Order Filler of the LTW Profile. The Label Broker is grouped with the Order Placer.

1760 **7.4.2.5.1 Placer Queries Filler Use Case Description**

- a) A test order is generated on the Order Placer side.

- 1765
- b) The Order Filler gets this order, schedules it and calculates the needed containers and associated barcode labels for this order.
 - c) In due time (preparation of the containers for an order group), a query from the Order Placer/Label Broker to the Order Filler/Label Information Provider is issued to get labeling instructions for the specimens to be collected for this order group number.
 - d) The Label Information Provider grouped with the Order Filler responds with the labeling instructions.
- 1770
- e) The Label Broker issues the barcode labels. The labels are attached to the corresponding containers.
 - f) The labeled containers are then used for specimen collection and then sent to the laboratory for testing.

7.4.2.5.2 Placer Queries Filler Use Case Process Flow

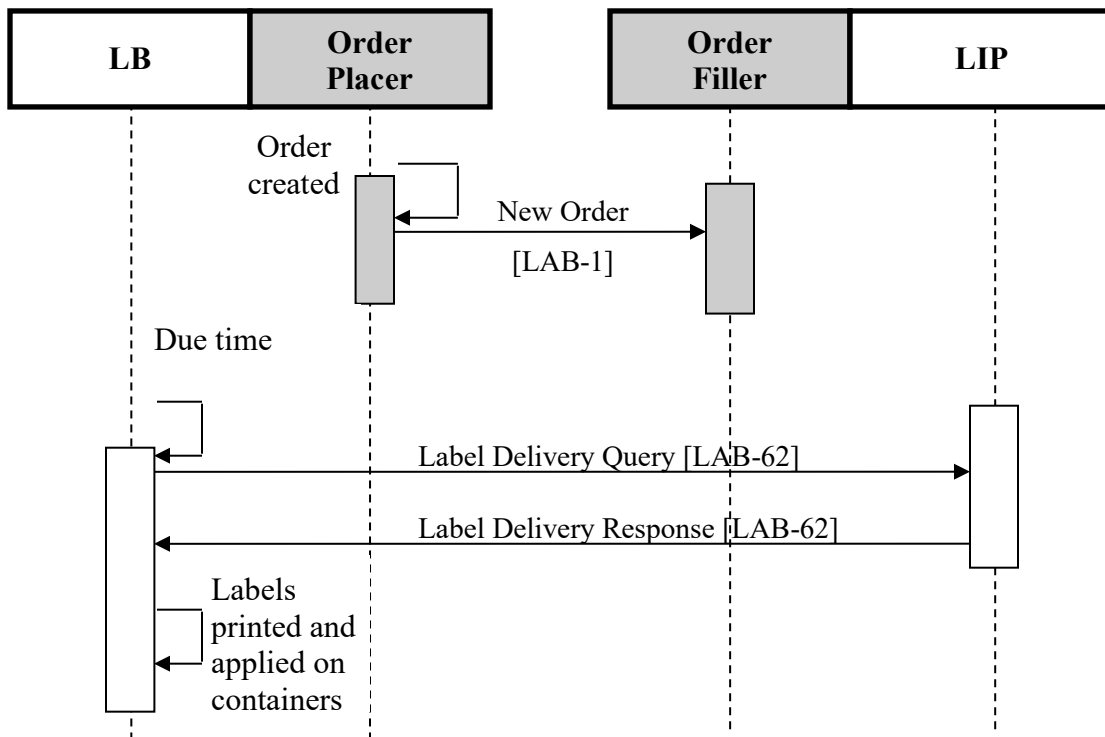

1775 **Figure 7.4.2.5.2-1: Filler Queried Process Flow in LBL Profile**

7.5 LBL Security Considerations

See Appendix A

7.6 LBL Cross Profile Considerations

1780 None.

8 Laboratory Code Set Distribution (LCSD) Profile

1785 A set of common codes is generally used by multiple application systems in a laboratory workflow environment. These common codes need to be synchronized across the various applications at a given site. In many implementations, one application system will be the author (the "owner") of the code set. The responsibility for managing a code set may also be distributed among different systems.

This profile provides a way for the owner of a code set (battery, test and observation codes) to send the code set to other applications in any specialties of clinical and anatomic pathology.

8.1 LCSD Actors and Transactions

1790 This section defines the actors, transactions, and/or content modules in this profile. General definitions of actors are given in the Technical Frameworks General Introduction Appendix A published [here](#).

Figure 8.1-1 shows the actors directly involved in the LAW Profile and the relevant transactions between them.

1795

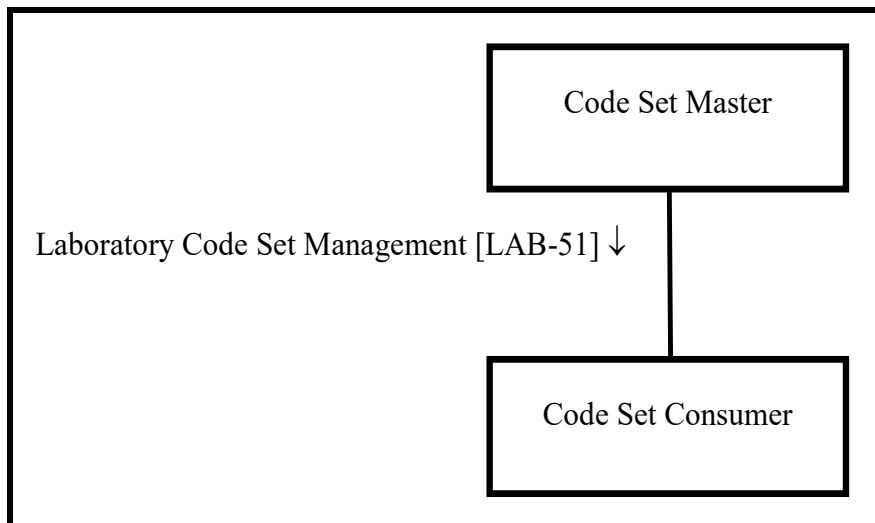

Figure 8.1-1: LCSD Actor Diagram

1800 Table 8.1-1 lists the transactions for each actor directly involved in the LCSD Profile. To claim compliance with this profile, an actor shall support all required transactions (labeled "R") and may support the optional transactions (labeled "O").

Table 8.1-1: Laboratory Code Set Distribution – Actors and Transactions

Actors	Transactions	Optionality	Section in Vol. 2
Code Set Master	Laboratory Code Set Management [LAB-51]	R	PaLM TF-2c: 3.39
Code Set Consumer	Laboratory Code Set Management [LAB-51]	R	PaLM TF-2c: 3.39

1805

8.1.1 Actor Descriptions and Actor Profile Requirements

Most requirements are documented in Transactions (Volume 2). This section documents any additional requirements on profile's actors.

8.2 LCSD Actor Options

1810 Options that may be selected for each actor in this profile are listed in the Table 8.2-1.

Table 8.2-1: Laboratory Code Set Distribution - Actors and Options

Actor	Option Name	Reference
Code Set Master	<i>Batch</i>	PaLM TF-2c: 3.39.4
Code Set Consumer	<i>Batch</i>	PaLM TF-2c: 3.39.4

8.2.1 Batch

1815 The batch option enables to group the set of messages carrying a new release of a code set into a batch, so as to synchronize the two actors, and let the Code Set Consumer make sure that it has received the complete code set. This option SHALL be supported by both actors or by none. Implementers of this profile are strongly recommended to support this option.

8.3 LCSD Required Actor Groupings

1820 An actor from this profile (Column 1) shall implement all of the required transactions and/or content modules in this profile *in addition to* all of the transactions required for the grouped actor (Column 2).

Table 8.3-1: Laboratory Code Set Distribution - Required Actor Groupings

LCSD Actor	Actor to be grouped with	Reference	Content Bindings Reference
Code Set Master	none		n.a.
Code Set Consumer	none		n.a.

1825 **8.4 LCSD Overview**

8.4.1 Concepts

8.4.2 Use Cases

8.4.2.1 Use Case #1: Full Code Set

8.4.2.1.1 Full Code Set Use Case Description

1830 The entire code set is sent to subscribing systems. These systems must replace their current release of the code set by the new one. Codes which have been removed from the code set are not to be used by the receiving system any more. Codes which have been removed should not be deleted but be flagged as disabled/invalid for backward compatibility reasons. New added codes may be used from the effective date/time given in the transaction.

1835 **8.4.2.1.2 Full Code Set Use Case Process Flow**

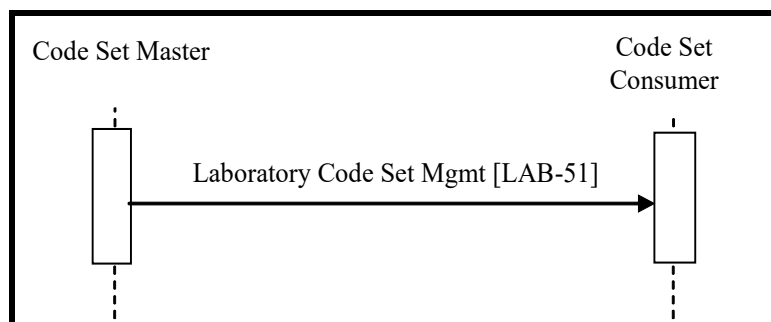

Figure 8.4.2.1.2-1: Full Code Set Process Flow in LCSD Profile

1840 **8.5 LCSD Security Considerations**

See Appendix A

8.6 LCSD Cross Profile Considerations

None.

9 Sharing Laboratory Reports (XD-LAB) Profile

1845 This Content Profile describes a laboratory report as a digital document to be shared with care providers via a document sharing resource or to be sent to a care provider, using a messaging or media interchange solution.

Such an electronic document contains the set of releasable results produced by a clinical laboratory or by a public health laboratory in fulfillment of one or more test orders for a patient.

1850 The report is shared in a human-readable format. In addition, this digital laboratory report contains test results in a machine-readable format, to facilitate the integration of these observations in the database of a consumer system.

The scope covers all laboratory specialties except anatomic pathology.

9.1 XD-LAB Actors, Transactions, and Content Modules

1855 This section defines the actors, transactions, and/or content modules in this profile. General definitions of actors are given in the Technical Frameworks General Introduction Appendix A published [here](#).

Figure 9.1-1 shows the actors directly involved in the XD-LAB Profile and the direction that the content is exchanged.

1860 A product implementation using this profile must group actors from this profile with actors from a workflow or transport profile to be functional. The grouping of the content module described in this profile to specific actors is described in more detail in the “Required Actor Groupings” section below.



1865 **Figure 9.1-1: XD-LAB Actor Diagram**

Table 9.1-1 lists the content module(s) defined in the XD-LAB Profile. To claim support with this profile, an actor shall support all required content modules (labeled “R”) and may support optional content modules (labeled “O”).

1870

Table 9.1-1: Sharing Laboratory Reports – Actors and Transactions

Actors	Content Modules	Optionality	Section in Vol. 3
Content Creator	Clinical Laboratory Report	R	PaLM TF-3: 6.3.1.1
Content Consumer	Clinical Laboratory Report	R	PaLM TF-3: 6.3.1.1

9.1.1 Actor Descriptions and Actor Profile Requirements

Most requirements are documented in Content Modules (Volume 3). This section documents any additional requirements on profile’s actors.

1875 **9.2 XD-LAB Actor Options**

Options that may be selected for each actor in this profile are listed in the Table 9.2-1. These options are further detailed in PCC Technical Framework Volume 2 as indicated in the rightmost column.

1880

Table 9.2-1: Sharing Laboratory Reports - Actors and Options

Actor	Option Name	Reference
Content Creator	None	
Content Consumer	View Option (1)	PCC TF-2: 3.1.1
	Document Import Option (1)	PCC TF-2: 3.1.2
	Section Import Option (1)	PCC TF-2: 3.1.3
	Discrete Data Import Option (1)	PCC TF-2: 3.1.4

Note 1: The Content Consumer shall support at least one of these options.

9.3 XD-LAB Required Actor Groupings

1885

An actor from this profile (Column 1) shall implement all of the required transactions and/or content modules in this profile *in addition to* all of the transactions required for the grouped actor (Column 2).

In some cases, required groupings are defined as at least one of an enumerated set of possible actors; this is designated by merging column one into a single cell spanning multiple potential grouped actors. Notes are used to highlight this situation.

1890

Section 9.5 describes some optional groupings that may be of interest for security considerations and Section 9.6 describes some optional groupings in other related profiles.

Table 9.3-1: Sharing Laboratory Reports - Required Actor Groupings

XD-LAB Actor	Actor to be grouped with	Reference	Content Bindings Reference
Content Creator	ITI XDS.b Document Source	ITI TF-1: 10	
	OR		
	ITI XDM Portable Media Creator	ITI TF-1: 16	
	OR		
	ITI XDR Document Source	ITI TF-1: 15	

XD-LAB Actor	Actor to be grouped with	Reference	Content Bindings Reference
Content Consumer	ITI XDS.b Document Consumer OR ITI XDM Portable Media Consumer OR ITI XDR Document Recipient	ITI TF-1: 10 ITI TF-1: 16 ITI TF-1: 15	

Note 1: Each actor of XD-LAB SHALL be grouped with at least one of the ITI actors listed in its table row.

1895

9.4 XD-LAB Overview

9.4.1 Concepts

This profile specifies a general document template, which can be used to produce digital laboratory reports from any specialties of a laboratory medicine.

1900

9.4.2 Use Cases

9.4.2.1 Use Case #1: Hospital Laboratory Report Shared at Discharge Time

At patient discharge time, a hospital physician selects the most significant reports produced by various facilities during the patient stay, including laboratory reports, and issues these reports individually to a health information exchange (e.g., XDS Affinity Domain) shared by a number of healthcare enterprises and primary care providers, for the purpose of continuity of care.

1905

9.4.2.2 Use Case #2 Private Laboratory Report Shared

A patient with a suspected urinary infection has been sent by her family doctor to a private laboratory downtown, with an order for a CBC and a urine microscopy and culture. Having fulfilled the order, the clinical laboratory sends its digital report to the national or regional EHR to feed the patient record.

1910

9.4.2.3 Use Case #3 Ambulatory Physician Shares a Laboratory Report

A patient with a suspected urinary infection is seen by her family doctor who collects a urine sample and sends it to a reference laboratory with an order for a urine microscopy and culture. The laboratory returns the tests results (outside of this use case) to the family doctor who reviews the results, and orders a treatment to the patient. As requested by the patient, the doctor shares this laboratory report in the patient's PHR.

1915

9.4.2.4 Use Case #4 Cumulative report built and shared at discharge time

At discharge time of an inpatient, a hospital physician selects the most significant lab results, produced by one or more laboratories of the healthcare enterprise, and builds a cumulative report sent to a health info exchange shared by a number of healthcare enterprises and primary care providers. This cumulative report aggregates the observations related to one or more order

1920

groups. It is made available to anybody having access to the EHR, for instance the patient's family doctor.

1925 9.4.2.5 Use Case #5 Public Health Laboratory Report

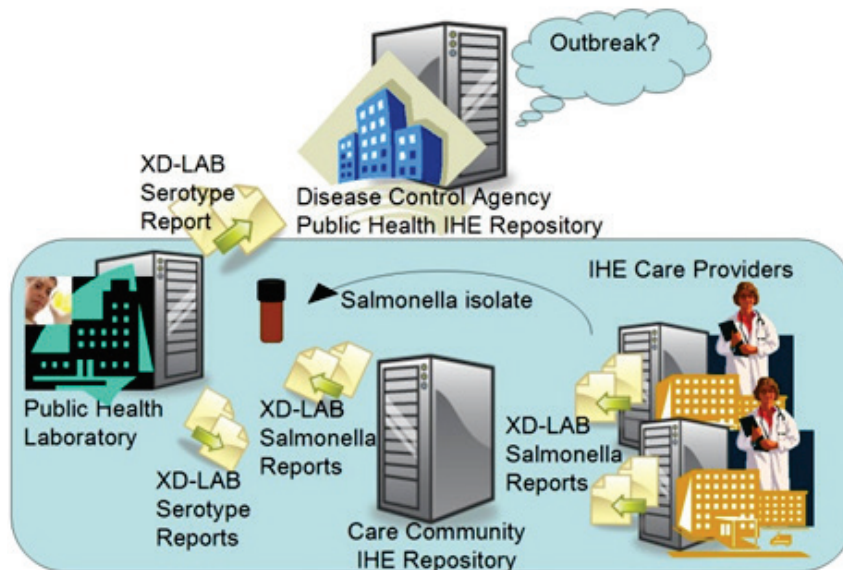

1930 John Doe, MD, sees a patient and suspects that this patient has an enteric pathogen. The patient follows through on the doctor's orders and submits a stool specimen to the clinic's laboratory. Upon completion of laboratory analysis, the laboratory confirms the presence of Salmonella and performs susceptibility testing. When a microbiologist has time in the week, they gather all the reportable results and complete the forms for submission to the public health agency. Additionally, the clinical laboratory needs to submit the Salmonella specimen to the public health laboratory for serotyping and outbreak surveillance. This specimen is mailed along with a hand written requisition to the public health laboratory for epidemiological serotyping.

1935

Preconditions: The clinical laboratory creates a laboratory report identifying the organism as a Salmonella isolate and that further serotyping will be done at the Public Health Lab. The laboratory report is sent to the clinician, stored within the patient's electronic medical record, and registered in a clinical interoperability registry. The isolate is mailed to the public health lab.

1940

Events: Upon arrival, the public health laboratory receiving department queries the clinical interoperability registry with the submitter's patient ID and views the initial laboratory report. The public health laboratory information system pulls forward the patient's demographic and specimen data from the initial laboratory report. The public health laboratory creates a new laboratory report identifying the Salmonella serotype. This report is sent to the clinician, stored within the patient's electronic medical record, registered in the clinical interoperability registry,

1945

registered in the regional public health interoperability registry, and registered in the national public health interoperability registry.

1950 The Disease Control agency monitors the national public health registry for new cases of Salmonella. An anomaly is immediately detected in the number of new cases for this particular Salmonella serotype when observed across regional surveillance boundaries and an outbreak protocol is started immediately to investigate the potential cross-border outbreak. The Disease Control agency requests PFGE (pulse field gel electrophoresis) on the current samples and alerts all public health laboratories to perform PFGE on new samples of this serotype. The outbreak is confirmed quickly and new cases are identified and tracked seamlessly.

Post conditions: Local, regional, and national epidemiologists and case workers have access to all laboratory reports within their respective interoperability registries and may potentially gain further access to the clinical interoperability registry for additional information, such as the ordering provider and care location, for initiating further investigation.

1960 **Key improvements include:**

- avoid handwritten forms and data re-entry
- ease transition of data to and from clinical care and public health agencies
- ease transition of data from one public health agency to another
- monitor registries for anomalies in a real-time basis
- response protocols focus on response, not the access to data

1965

Laboratory reportable conditions can be specified at local and national levels. Common laboratory criteria diagnostic of a reportable condition include (but are not limited to):

- Anthrax - *Bacillus anthracis*
- Botulism - *Clostridium botulinum*
- 1970 • Brucellosis - *Brucella* species
- *Campylobacter*
- *Chlamydia trachomatis*
- Cholera - *Vibrio cholerae*
- Dengue Fever - Dengue virus
- 1975 • Diphtheria - *Corynebacterium diphtheriae*
- *Escherichia coli* O157:H7
- Giardiasis - *Giardia lamblia*
- Gonorrhea - *Neisseria gonorrhoeae*
- *Haemophilus ducreyi*
- 1980 • Hepatitis virus
- Herpes Simplex virus
- HIV virus
- Legionellosis - *Legionella pneumophila*
- Leprosy - *Mycobacterium leprae*
- 1985 • Leptospirosis - *Leptospira*
- Listeriosis - *Listeria monocytogenes*

- Lyme Disease - *Borrelia burgdorferi*
- Malaria - *Plasmodium* species
- Measles virus
- 1990 • Meningococcal Disease - *Neisseria meningitidis*
- Mumps virus
- Pertussis - *Bordetella pertussis*
- Plague - *Yersinia pestis*
- Psittacosis - *Chlamydia psittaci*
- 1995 • Rabies virus
- Rickettsia - *Rickettsia rickettsii*
- Rubella virus
- Salmonella
- Shigella
- 2000 • Schistosomiasis
- Syphilis - *Treponema pallidum*
- Tuberculosis - *Mycobacterium tuberculosis*

9.5 XD-LAB Security Considerations

See Appendix A

2005 9.6 XD-LAB Cross Profile Considerations

None.

Appendix A – Security Environment Considerations

2010 This appendix is informative.

Systems compliant to the IHE PaLM Technical Framework profiles usually process private healthcare information. This is subject to national privacy regulations, and possibly other contractual requirements. The IHE profiles do not fully define the security mechanisms necessary to protect this information. The ITI-TF Audit Trail and Node Authentication (ATNA) Profile provides one component of this solution. IHE assumes that actors will be installed on nodes with the following characteristics:

- Each node has a security policy and procedure that applies to its operation. This is assumed to be part of the healthcare enterprise security policy.
- Any user (human, or application process) external to the node boundaries is submitted to an access control procedure in which the user/application will be authenticated.
- All required audit trail events are captured and recorded.

2020

The profiles in this framework assume the following environment:

- Physical Security Environment.
 - The systems and devices are assumed to be located in a physically protected and actively monitored area.
 - The network equipment that connects the computers is also assumed to be physically protected against unauthorized connections and unauthorized modifications. In the treatment areas of most hospitals the network equipment is in ceilings, cableways, locked cabinets, and other protected areas. There is usually staff present to monitor that no unauthorized activity is taking place.
- Remote locations, especially home offices, are not physically protected. Other means will be used to provide equivalent protection. This may include the use of technology such as VPN connections or HTTPS encryption. Use of encryption or VPN is not a complete replacement for physical security but may be part of an overall protection system.
- The home computer that is used for both personal and professional purposes is difficult to protect. It will be protected from inadvertent modification by malicious software or its use will be prohibited.

2025

2030

2035

- Network Security Environment

2040

- In addition to the physical security of the network, there will be protection against network access by unsupervised systems. This is typically provided by mechanisms such as firewalls and VPNs.

The threat profile is assumed to be:

- Accidental and inadvertent misuse.

- 2045
- Individual abuse for personal gain, malice, revenge, or curiosity. The abusers are assumed to have only limited access to the underlying systems and software. They are not expert at the internal structure of the systems.

- Random untargeted abuse, such as from an Internet hacker.

2050 The threat profile also assumes that the following threats are either not present or otherwise protected.

- Individual abuse by a system administrator, system developer, or other expert.
- Military or hostile government action.
- Organized criminal attack.

2055 IHE addresses only those security requirements related to IT systems within the scope of IHE healthcare applications. It does not address security requirements for defending against network attacks, virus infection, etc.

2060 IHE does not mandate the use of encryption because the performance impact of current encryption algorithms is excessive. Most hospital networks provide adequate security through physical and procedural mechanisms. The additional performance penalty for encryption is not justified for these networks. The profiles permit the use of encryption so that it can be used as part of an overall security plan.

Glossary

2065 The IHE Glossary can be found as an appendix to the *IHE Technical Frameworks General Introduction*, available on [this page](#).