

Integrating the Healthcare Enterprise



5

**IHE IT Infrastructure  
Technical Framework Supplement**

10

**Remove Metadata and Documents  
(RMD)**

15

**Rev. 1.0 – Draft for Public Comment**

20 Date: March 1, 2017  
Author: ITI Technical Committee  
Email: [iti@ihe.net](mailto:iti@ihe.net)

25

**Please verify you have the most recent version of this document. See [here](#) for Trial Implementation and Final Text versions and [here](#) for Public Comment versions.**

## Foreword

30 This is a supplement to the IHE IT Infrastructure Technical Framework V13.0. Each supplement undergoes a process of public comment and trial implementation before being incorporated into the volumes of the Technical Frameworks.

This supplement is published on March 1, 2017 for public comment. Comments are invited and can be submitted at [http://ihe.net/ITI\\_Public\\_Comments](http://ihe.net/ITI_Public_Comments). In order to be considered in the development of the trial implementation version of the supplement, comments must be received 35 by March 31, 2017.

This supplement describes changes to the existing technical framework documents.

“Boxed” instructions like the sample below indicate to the Volume Editor how to integrate the relevant section(s) into the relevant Technical Framework volume.

<i>Amend Section X.X by the following:</i>
--

40 Where the amendment adds text, make the added text **bold underline**. Where the amendment removes text, make the removed text **~~bold strikethrough~~**. When entire new sections are added, introduce with editor’s instructions to “add new text” or similar, which for readability are not bolded or underlined.

45 General information about IHE can be found at [www.ihe.net](http://www.ihe.net).

Information about the IHE IT Infrastructure domain can be found at [http://www.ihe.net/IHE\\_Domains](http://www.ihe.net/IHE_Domains).

Information about the structure of IHE Technical Frameworks and Supplements can be found at [http://www.ihe.net/IHE\\_Process](http://www.ihe.net/IHE_Process) and <http://www.ihe.net/Profiles>.

50 The current version of the IHE Technical Framework can be found at [http://www.ihe.net/Technical\\_Frameworks](http://www.ihe.net/Technical_Frameworks).

## CONTENTS

55	Introduction to this Supplement.....	5
	Open Issues and Questions .....	6
	Closed Issues .....	6
	General Introduction .....	10
60	Appendix A - Actor Summary Definitions .....	10
	Appendix B - Transaction Summary Definitions .....	10
	<b>Volume 1 – Integration Profiles.....</b>	<b>11</b>
	X Remove Metadata and Documents (RMD) Profile.....	11
	X.1 RMD Actors/Transactions .....	11
65	X.1.1 Actor Descriptions and Requirements.....	13
	X.2 RMD Actor Options .....	13
	X.3 RMD Required Actor Groupings .....	13
	X.4 RMD Overview .....	14
	X.4.1 Concepts .....	14
70	X.4.2 Use Cases .....	14
	X.4.2.1 General Use Case.....	14
	X.4.2.1.1 General Use Case Description .....	14
	X.4.2.1.2 Process Flow .....	14
	X.5 RMD Security Considerations .....	16
75	X.6 RMD Cross Profile Considerations.....	16
	X.6.1 XDS Document Registry.....	16
	X.6.2 XDS Document Repository.....	17
	<b>Volume 2a – Transactions Part A.....</b>	<b>19</b>
	3.18.2 Use Case Roles.....	19
80	<b>Volume 2b – Transactions Part B.....</b>	<b>20</b>
	3.62 Remove Metadata.....	20
	3.62.1 Scope .....	20
	3.62.2 Actor Roles.....	20
	3.62.3 Referenced Standard .....	20
85	3.62.4 Interaction Diagram.....	21
	3.62.4.1 Remove Metadata Request.....	21
	3.62.4.1.1 Trigger Events .....	21
	3.62.4.1.2 Message Semantics.....	21
	3.62.4.1.3 Expected Actions .....	22
90	3.62.4.2 Remove Metadata Response.....	23
	3.62.4.2.1 Trigger Events .....	23
	3.62.4.2.2 Message Semantics.....	23
	3.62.4.2.3 Expected Actions .....	24
	3.62.5 Security Considerations.....	24
95	3.62.5.1 Security Audit Record Considerations .....	24
	3.62.5.1.1.1 Document Administrator audit message.....	26

	3.62.4.2.4.2 Document Registry audit message.....	28
	<b>Volume 2c – Transactions Part C.....</b>	<b>30</b>
	3.Y1 Remove Documents .....	30
100	3.Y1.1 Scope .....	30
	3.Y1.2 Actor Roles.....	30
	3.Y1.3 Referenced Standard.....	30
	3.Y1.4 Interaction Diagram.....	31
	3.Y1.4.1 Remove Documents Request.....	31
105	3.Y1.4.1.1 Trigger Events.....	31
	3.Y1.4.1.2 Message Semantics .....	31
	3.Y1.4.1.3 Expected Actions .....	32
	3.Y1.4.2 Remove Documents Response .....	33
	3.Y1.4.2.1 Trigger Events.....	33
110	3.Y1.4.2.2 Message Semantics .....	33
	3.Y1.4.2.3 Expected Actions .....	34
	3.Y1.5 Security Considerations.....	34
	3.Y1.5.1 Audit Record Considerations.....	34
	3.Y1.5.1.1 Document Administrator audit message.....	35
115	3.Y1.5.1.2 Document Repository audit message.....	37
	<b>Volume 2x-Appendices .....</b>	<b>39</b>
	Appendix V: Web Services for IHE Transactions.....	39
	<b>Volume 3 Cross-Transaction and Content Specifications.....</b>	<b>40</b>
120		

## Introduction to this Supplement

125 Notice: This supplement includes the Delete Document Set transaction [ITI-62] previously found in the XDS Metadata Update Supplement. This transaction has been renamed and is now known as the Remove Metadata transaction. The Delete Document Set transaction will be removed from the XDS Metadata Update Supplement through CP-ITI-1018.

130 The Remove Metadata and Documents (RMD) Profile was developed to allow for the removal of metadata from the Document Registry and documents from a Document Repository that are no longer required to be discoverable within a patient's care record. The decision to remove this data may have been initiated either by an automated mechanism or manual administrative procedure in order to enforce a pre-determined policy or legal requirement within an XDS Affinity Domain.

135 This profiles combines both a new and existing functionality to fulfill these requirements: 1) a new transaction was developed to allow for the removal of the document from an XDS Repository, and 2) an existing transaction [ITI-62] was repurposed from the XDS Metadata Update Supplement for the removal of metadata from the Document Registry. The actor, Document Administrator, will be used to represent the requestor for both transactions.

140 The Technical Committee determined that the [ITI-62] transaction would be better represented within the RMD Profile in order to better demonstrate the requirements necessary for the complete removal of a patient care record within an XDS Affinity Domain. Furthermore, this transaction is not dependent on metadata versioning and could be used in XDS Affinity Domain environments whether or not any other capabilities described in the Metadata Update Supplement are implemented.

145 The Remove Metadata and Documents Profile does not address whether or not data should be physically removed from a host system. Because of the complex nature of local, regional, and national legal requirements surrounding patient privacy and data retention, this decision is left to implementers as to how to best address these requirements. National Extensions to this Profile may be introduced in the future to help address these issues.

150

## Open Issues and Questions

- 155 ***RMD\_010: Could ITI-62 be given additional functionality to allow for the automated removal of associated metadata objects, versions, and known copies within the Document Registry? Should a new transaction(s) be defined that would simplify the removal of metadata from the Document Registry?***

*Resolution: Time was not available to address the full scope of this issue within this TC work item. If there is demand shown during public comment, this may be addressed at a later time.*

## Closed Issues

- 160 **Note:** Issues included in this profile from the Metadata Update Supplement are indicated in parenthesis (e.g., MV031).

***RMD\_001: Should the workflow proposed by this transaction be directed at the Repository or Registry?***

- 165 *Resolution: It was agreed that two separate transactions are needed. The existing ITI-62 transaction shall remain pointed at the Document Registry. A new transaction will be created specifically for the Document Repository.*

***RMD\_002: What actor is responsible for the coordination of these transaction? Is a new actor needed?***

- 170 *Resolution: The work item will show a single actor, Document Administrator, being responsible for orchestrating both transactions. Text will be added to Volume 1 to show how the Document Administrator's responsibilities may be distributed with other XDS Actors.*

***RMD\_003: Should the work item remained defined for actors only within the XDS Affinity Domain (e.g., Cross-Community Remove)?***

- 175 *Resolution: Cross community considerations are out of scope for this supplement.*

***RMD\_004: Should the transactions also support asynchronous calls and workflow?***

*Resolution: It was felt that the demand was not sufficient to warrant including asynchronous workflow and/or language within this supplement.*

- 180 ***RMD\_005: Should a new state be added to represent the removal of metadata in the Document Registry and/or binary stored in the Document Source/Repository? Or should this be left for implementers to decide?***

*Resolution: It was felt, that unless new requirements are discovered during the development of this supplement, this would left to implementers. It was agreed, though, that any new states should at least be brought out in context and informatively discussed in the Supplement.*

185 **RMD\_007: Could the Document Repository just use the DocumentAvailability attribute and set the status to Online/Offline?**

*Resolution: It was agreed that the Offline status does not mean that the document has been permanently removed from the system and could be brought back Online. Thus, this was rejected.*

190 **RMD\_008: Should either transaction be required to enforce patient identifier rules that are consistent with other XDS/XDR submit and update transactions (e.g., to be removed, all objects must have the same patient identifier)?**

*Resolution: Currently, ITI-62 does not have this restriction. Both transactions are intended for administrative use only.*

195 **RMD\_009: Confirm that the existing ITI-62 transaction should be used for the removal of other metadata objects beside DocumentEntry objects and its related Association objects. If so, what additional guidance should be provided to implementers?**

*Resolution: Technically, ITI-62 did not have any technical limitations to prevent implementer from removing Submission Sets or Folders within this transaction. For this profile, this transaction has been renamed to better describe its use.*

200

*This is being further address in RMD\_010.*

**RMD\_011: Should ITI-62 be the only method for requesting that a patient record be removed from an XDS Affinity Domain? How about an HL7<sup>®1</sup>-V2 or FHIR<sup>®2</sup> message?**

*Resolution: This remains out of scope for this supplement.*

205 **RMD\_012: Should the Document Administrator be used for this supplement or is a different actor needed (e.g., Content Updater/Remover)? This might be done to better focus the supplement and help if RMD is not published in concurrence with MU.**

*Resolution: It was felt that reusing existing actors for this profile would allow for a better comprehension by implementers.*

210 **RMD\_013: Do restrictions need to be added to ITI-62 to restrict users from removing only prior versions of metadata and leaving just the latest version?**

*Resolution: This will be addressed if any rules and/or restrictions for metadata versioning are introduced in Metadata Update Supplement. Currently, the ebXML standard allows for the removal of both approved and deprecated objects which is sufficient for non-MU environments.*

215 **RMD\_014: Should the existing MU transactions be renamed to improve and better identify their expected actions (e.g., Update Document Set to Update Metadata/Delete Document Set to Remove Metadata? What about the Actor Options?**

---

<sup>1</sup> HL7 is the registered trademark of Health Level Seven International.

<sup>2</sup> FHIR is the registered trademark of Health Level Seven International.

220 *Resolution: With this profile, the Delete Document Set transaction was renamed to better reflect its use within this profile and technical capabilities. The transactions, wsa:Action, though, cannot be changed as this would be considered a breaking change for existing implementations.*

***RMD\_015 (MV031): Metadata Update and Delete will both require significant authentication/authorization challenges. Should these be mandated by this profile or left to be decided upon by developers?***

*Resolution: Recommendations made in security sections. No mandates made.*

225 ***RMD\_016 (MV038): Should ITI establish rules for the deletion of metadata? Example is a submission of a DocumentEntry with its attendant SubmissionSet and HasMember association. The minimal deletion of the DocumentEntry must delete the association as well. This leaves a SubmissionSet with no contents. Should the profile require the deletion of the SubmissionSet as well? Obviously more complicated examples exist.***

230 *MU Resolution: IHE has not added any restrictions to be base standard. The amount of deletion is not restricted.*

*Resolution: This has been addressed by providing new guidance to allow full removal of metadata. In addition, a new requirement and error code has been added to ITI-62 to encourage the removal of a non-referenced Submission Set as best practice.*

235 ***RMD\_017 (MV042): A public comment made issue of the lack of a defined way to request a deletion from the Document Repository. This has been recorded as Change Proposal 533.***

*Resolution: This is being address with this supplement.*

***RMD\_018: Should an On-demand Document Source be included in Volume 1 material for the Remove Documents transaction?***

240 *Resolution: It was felt that no special processing was required by this actor.*

***RMD\_019: Should the XDS Document Source be specifically called-out in this profile as an optional target for the Remove Documents transaction? This would address a weakness in this Profile that was called-out during the Planning Committee presentation.***

245 *Resolution: It was felt that adding this case was not necessary. The actors and transactions are flexible to accommodate this workflow, if desired.*

***RMD\_020 (CP-ITI-810/CP-ITI-984): Should the ATNA audit message for the ITI-62 transaction include a ParticipantObjectTypeCode entry for Association objects? If so, what classification uuid should be used for HasMember associations (classification uuid's exist for relationship associations)? Should the message be grouped by the patient identifier?***

250 *Resolution: Submission Set and Folder classification nodes were added. Association objects have also been added and will use the association type as its identifier. A statement was added to the Security Considerations section indicating to implementers that more than one patient identifier could be referenced by a metadata object. Rejected the generic entry for ebXML RegistryObject as it resides outside the XDS metadata model. This could be added by an*  
255 *implementer, if needed.*



***RMD\_021: Should RMD include the XDR Document Recipient for ITI-62?***

260 *Resolution: Agreement was reached not to include a Document Recipient requirement in RMD. This requirement originated in ITI-62 as currently written for the Metadata Update Supplement but it was unclear as to why these requirements were originally included. Also influencing this decision was that MU was in trial implementation and keeping RMD focused on the primary use cases. This still could be included as a cross-profile consideration later, if needed.*

***RMD\_022: Should ITI-18 be updated to add the Document Administrator before FT?***

*Resolution: Text has been added and graphic updated.*

265

## General Introduction

270 *Update the following Appendices to the General Introduction as indicated below. Note that these are not appendices to Volume 1.*

### Appendix A - Actor Summary Definitions

*Add the following actors to the IHE Technical Frameworks General Introduction list of actors:*

Actor	Definition
Document Administrator	The Document Administrator is an actor capable of updating and/or removing metadata from the Document Registry. This actor may also be capable of removing associated documents from the Document Repository.

### Appendix B - Transaction Summary Definitions

275 *Add the following transactions to the IHE Technical Frameworks General Introduction list of Transactions:*

Transaction	Definition
Remove Metadata [ITI-62]	The Remove Metadata transaction is used by the Document Administrator to remove of one or more metadata objects from a Document Registry.
Remove Documents [ITI-Y1]	The Remove Documents transaction is used by the Document Administrator to request the removal of documents from a Document Repository.

# Volume 1 – Integration Profiles

## **X Remove Metadata and Documents (RMD) Profile**

- 280 The Remove Metadata and Documents (RMD) Profile supports the removal of metadata from the Document Registry and documents from a Document Repository which are no longer required to be discoverable within a patient's care record. The decision to remove this data may have been initiated either by an automated mechanism or manual administrative procedure in order to enforce a pre-determined policy or legal requirement within an XDS Affinity Domain.
- 285 The Remove Metadata and Documents Profile does not address whether or not data should be physically removed from a host system. Because of the complex nature of local, regional, and national legal requirements surrounding patient privacy and data retention, this decision is left to implementers as to how to best address these requirements. National Extensions to this Profile may be introduced in the future to help address these issues.

### **290 X.1 RMD Actors/Transactions**

Figure X.1-1 shows the actors directly involved in the RMD Profile and the relevant transactions between them.

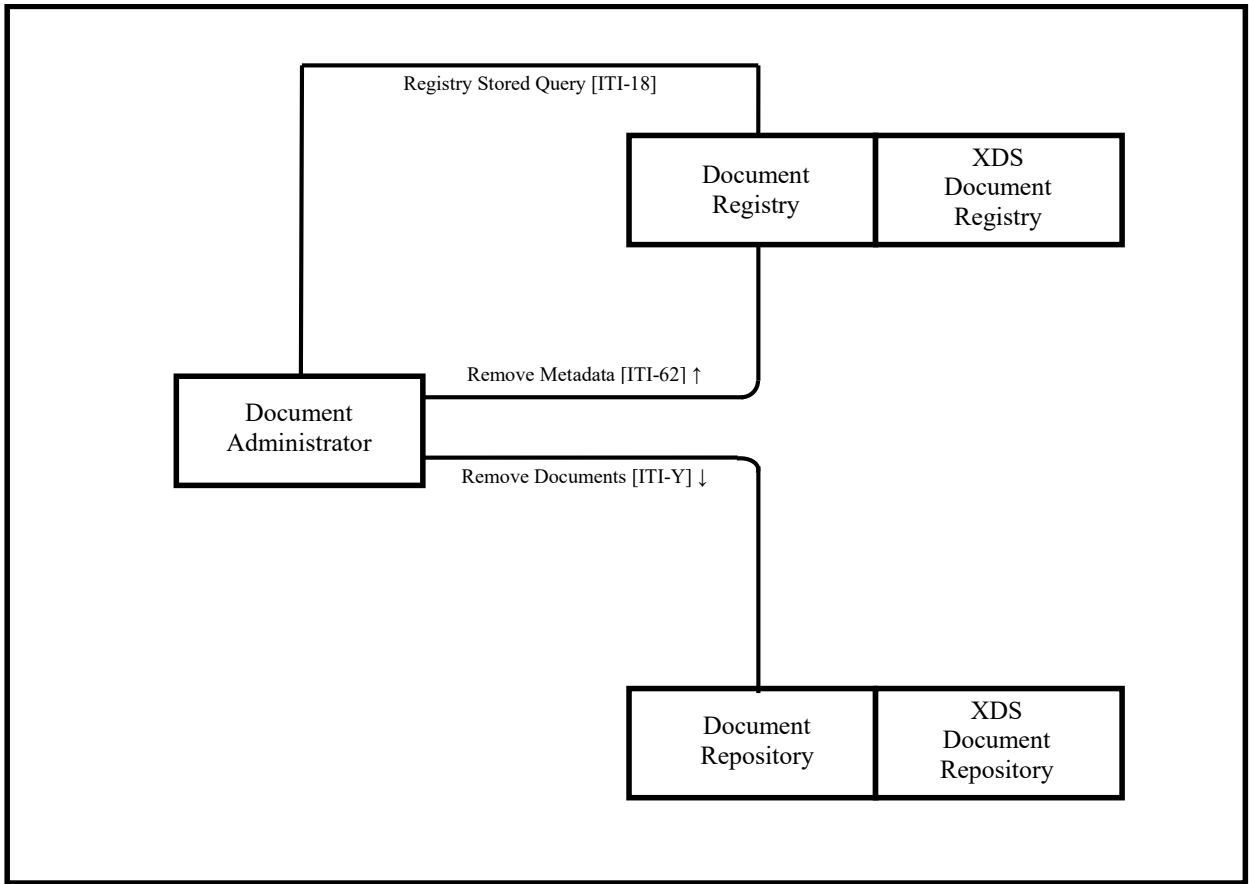

295

**Figure X.1-1: RMD Actor Diagram**

Table X.1-1 lists the transactions for each actor directly involved in the RMD Profile. To claim compliance with this Profile, an actor shall support all required transactions (labeled “R”) and may support the optional transactions (labeled “O”).

300

**Table X.1-1: RMD Profile - Actors and Transactions**

Actors	Transactions	Optionality	Reference
Document Administrator	Remove Metadata [ITI-62]	O ( See note 1)	ITI TF-2b: 3.62
	Remove Documents [ITI-Y1]	O ( See note 1)	ITI TF-2c: 3.Y1
	Registry Stored Query [ITI-18]	O	ITI TF-2a: 3.18
Document Registry	Remove Metadata [ITI-62]	R	ITI TF-2b: 3.62
Document Repository	Remove Documents [ITI-Y1]	R	ITI TF-2b: 3.Y1

Note 1: The Document Administrator shall support at least one of the following transactions: Remove Metadata [ITI-62] or Remove Documents [ITI-Y1].

305 **X.1.1 Actor Descriptions and Requirements**

**X.2 RMD Actor Options**

Options that may be selected for each actor in this profile, if any, are listed in the Table X.2-1. Dependencies between options when applicable are specified in notes.

310 **Table X.2-1: RMD - Actors and Options**

Actor	Option Name	Reference
Document Administrator	No options defined	--
Document Registry	No options defined	--
Document Repository	No options defined	--

**X.3 RMD Required Actor Groupings**

315 An actor from this profile (Column 1) shall implement all of the required transactions and/or content modules in this profile *in addition to* all of the transactions required for the grouped actor (Column 2).

**Table X.3-1: RMD - Required Actor Groupings**

RMD Actor	Profile/Actor to be grouped with	Reference
Document Administrator	ATNA / Secure Node or Secure Application	ITI TF-1: 9.4
	CT / Time Client	ITI TF-1: 7.1
Document Registry	XDS Document Registry	ITI TF-1: 10.1.1.3
Document Repository	XDS Document Repository	ITI TF-1: 10.1.1.4
	or XDS Integrated Document Source/Repository	ITI TF-1: 10.1.1.6

## **X.4 RMD Overview**

### **320 X.4.1 Concepts**

The Remove Metadata and Documents Profile supports the means to prevent the discovery of specified patient records held by an XDS Affinity Domain. The Document Administrator actor initiates the removal of metadata from the Document Registry and documents from the Document Repository.

325 It is recommended that the document's metadata be removed from the Document Registry before removing the document from the Document Repository. This recommendation is due to the greater complexity of removing metadata from the Document Registry and the desire to limit the impact to Document Consumers. To allow for use in a variety of workflows, no dependencies between the success of the Remove Metadata and Remove Documents transactions are specified.

330 This is left for implementers to determine which configuration will work best for their environments.

When removing metadata, the Document Administrator is responsible for ensuring that the Document Registry is left in a consistent state. The Document Registry is responsible for verifying metadata integrity and consistency.

### **335 X.4.2 Use Cases**

#### **X.4.2.1 General Use Case**

The Document Administrator acts on behalf of the XDS Affinity Domain when patient records need to be removed from its systems. The Document Administrator requests the removal of metadata from the Document Registry and associated documents from the Document Repository.

##### **340 X.4.2.1.1 General Use Case Description**

Patient D went to the community hospital because of an urgent medical problem. The interviewing physician wrote an impression document which was provided to the Document Repository and registered in the hospital's Document Registry. Patient D found that the document was inappropriate, and demanded the complete removal of all versions of the document from the hospital's records. The hospital found the claims of Patient D to be valid and agreed to remove its registration from the Document Registry and this document from the Document Repository. Once removed, the specified document can no longer be discovered on the hospital's system.

##### **X.4.2.1.2 Process Flow**

350

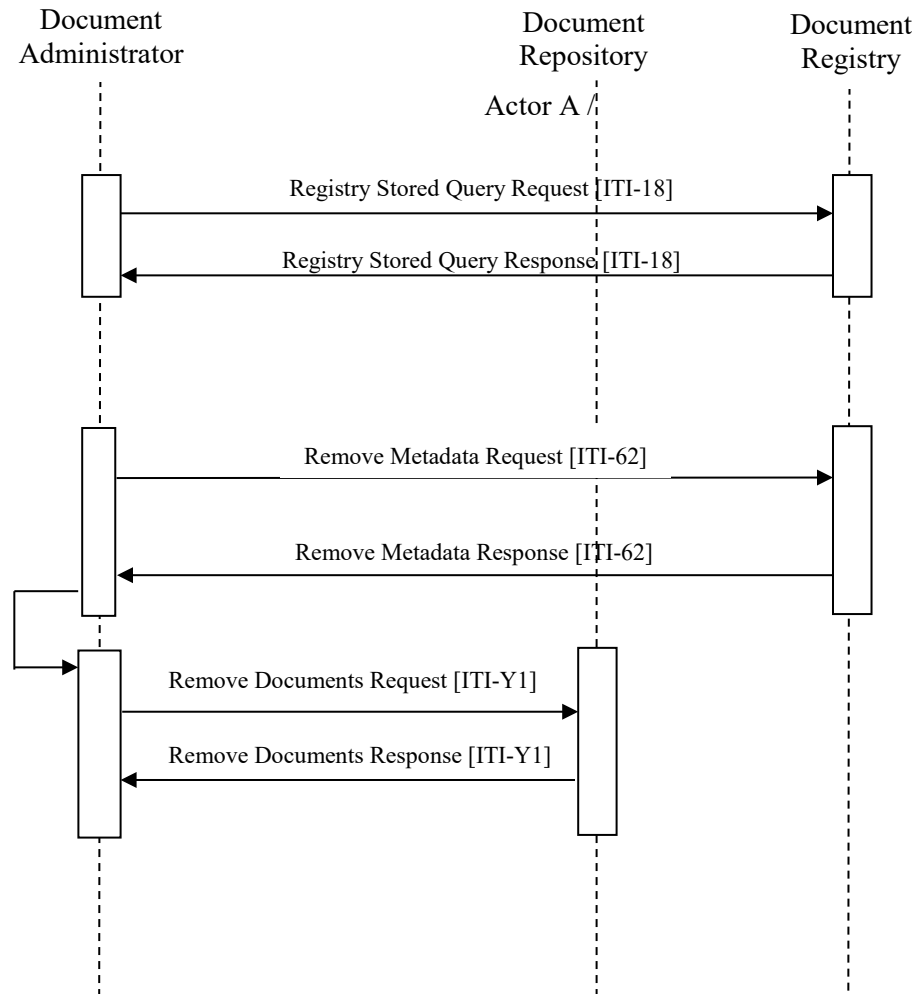

**Figure X.4.2.1.2-1: Basic Process Flow in RMD Profile**

355 Based on policy agreements of the XDS Affinity Domain, the Document Administrator must ensure that a specific document, in this case the impression document, is no longer discoverable by Document Consumers. A series of steps are required to successfully complete this process by the Document Administrator.

360 The Document Administrator first determines which registry objects are affected by querying the Document Registry for the document it wants to removed. Next, a second query is made to the Document Registry to identify all appended, transformed, and replacement versions of the document. Based on the result, the Document Administrator now knows the list of identifiers that will be used to remove the document metadata object(s) from the Document Registry and also to remove the document(s) stored in the Document Repository.

365 But before submitting the Remove Metadata Request, the Document Administrator must perform an additional step to query for Association objects that reference the document(s) previously identified. Then, the Document Administrator must look for Submission Sets that would be left empty. This result is added to the list of identifiers that will be submitted in the request to the Document Registry. These steps are necessary to help ensure that the Document Registry remains in a consistent state.

370 Now that all the metadata objects have been identified, the Document Administrator requests that these objects be removed from the Document Registry. If successful, the metadata will no longer appear in the query results. The Document Administrator next requests the Document Repository remove the document(s) from its system. If successful, the document is no longer retrievable and the process has been completed.

### 375 **X.5 RMD Security Considerations**

For general IHE risks and threats please see ITI TF-1: Appendix L. Implementers are also advised that many risks cannot be mitigated by the IHE profile and instead the responsibility for mitigation is transferred to the implementer as well as the administrators and participants within the XDS Affinity Domain. In these instances, IHE's responsibility to notify affected parties is fulfilled by this section.

380 Policy decisions can be made during planning phase of an XDS Affinity Domain to determine legal requirements defining patient record discovery and the suitability of these transactions for use within an XDS Affinity Domain. Software and equipment should be evaluated in order to determine whether or not it can support these policy decisions prior to implementation. Strong encryption, authentication, authorization and auditing methods should always be used and enforced.

Specific security considerations are presented in the Security Considerations section of each transaction in Volume 2.

### **X.6 RMD Cross Profile Considerations**

390 This section describes how the Document Administrator might be used when grouped with other actors within an XDS Affinity Domain.

#### **X.6.1 XDS Document Registry**

395 An XDS Document Registry might be grouped with the Document Administrator to allow it to enforce a policy based decision for the removal of metadata from its system. In this configuration, the Document Administrator makes the decision and internally notifies the Document Registry to remove the metadata. After the metadata has been removed, the Document Administrator then requests to remove the documents from the Document Repository using the Remove Documents [ITI-Y1] transaction.



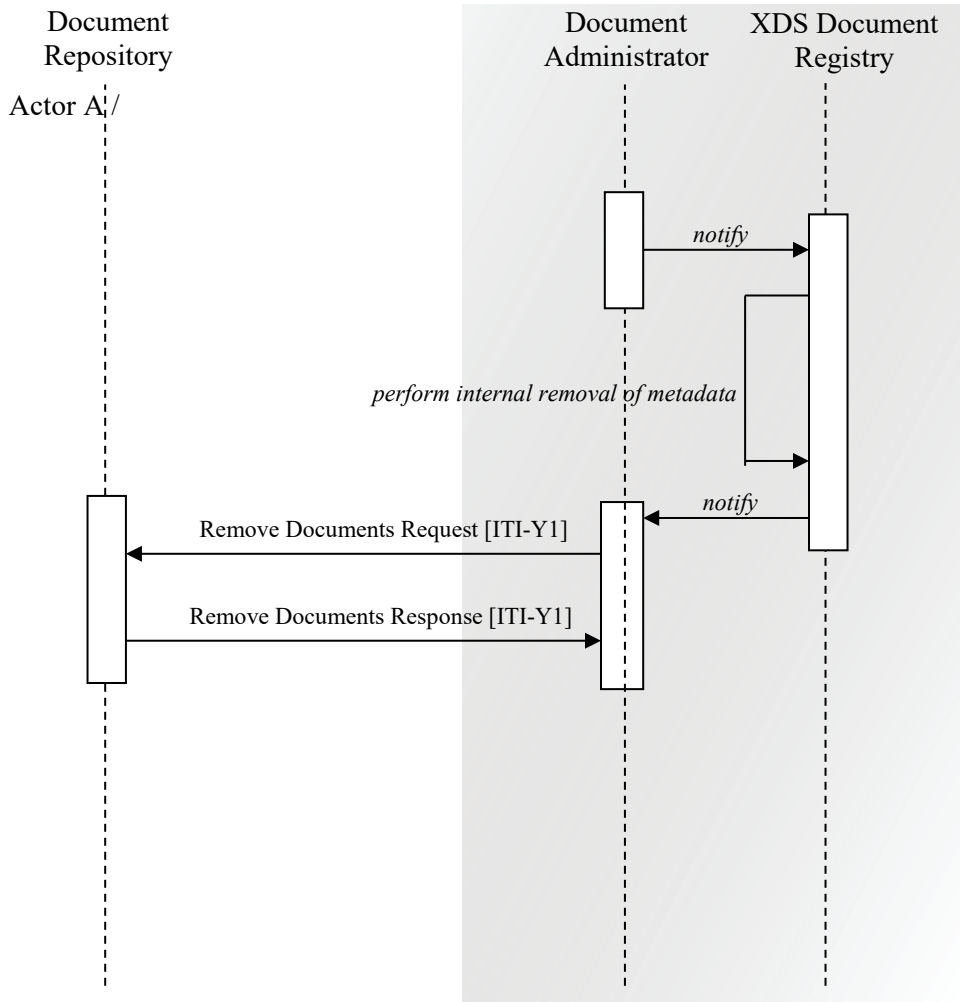

400

**Figure X.6.1-1: XDS Document Registry/Administrator Process Flow**

### X.6.2 XDS Document Repository

405 An XDS Document Repository might be grouped with the Document Administrator to allow it to enforce a policy based decision based on a request to remove a document from its system. In this configuration, the Document Administrator would be responsible for requesting the removal of the metadata from Document Registry using the Remove Metadata [ITI-62] transaction prior to removing the document from its system.

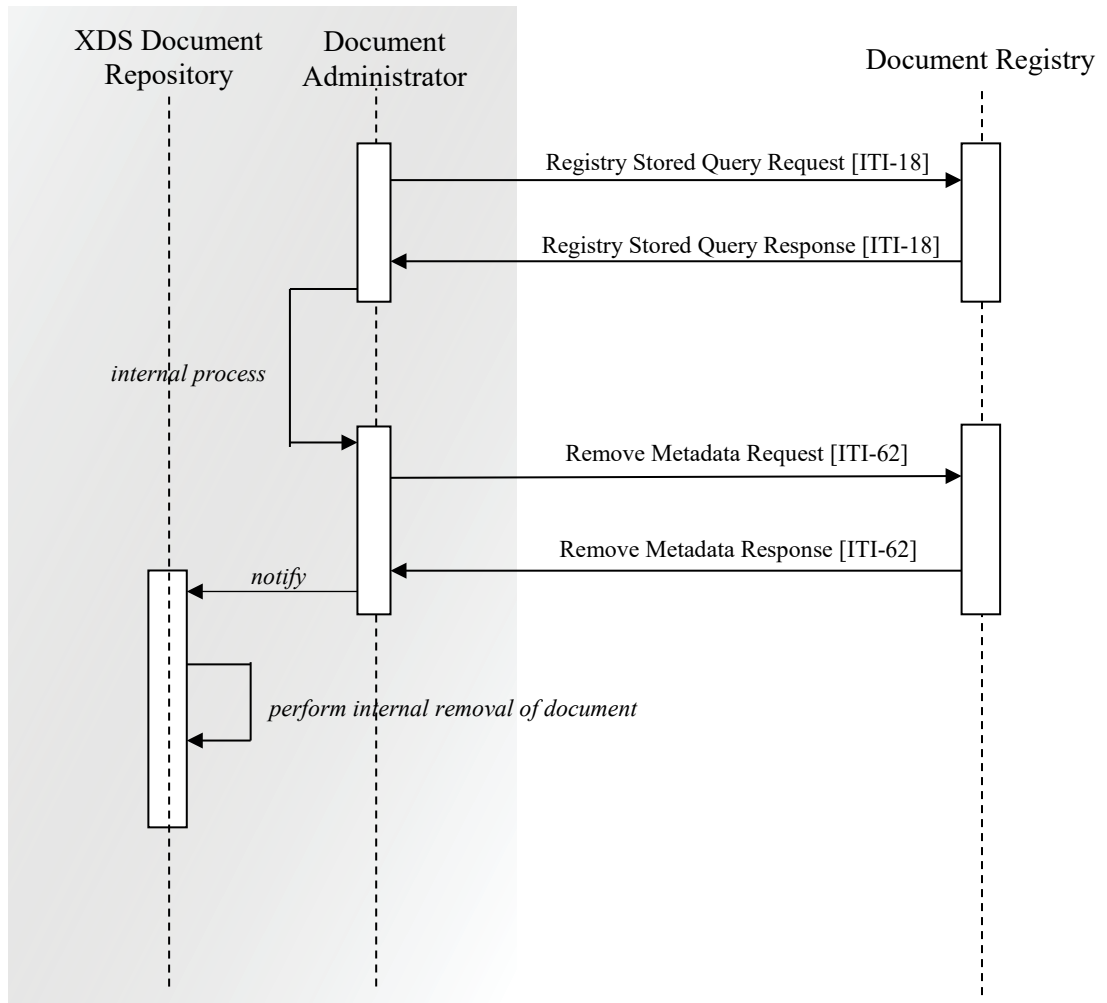

410

**Figure X.6.2-1: XDS Document Repository/Administrator Process Flow**

415

## Volume 2a – Transactions Part A

*Editor: Update Volume 2a-Section 3.18.2 Use Case Roles to add Document Administrator*

### 3.18.2 Use Case Roles

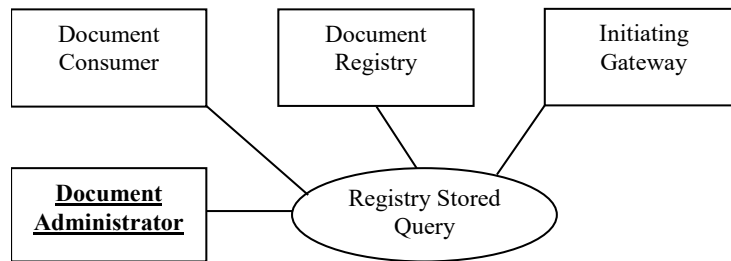

420

**Actor:** Document Consumer or Document Administrator

425

**Role:** Requests a query by identifier (UUID), and passes parameters to the query. A parameter controlling the format of the returned data is passed, it selects either object references or full objects.

**Actor:** Document Registry

**Role:** Services the query using its stored definitions of the queries defined for XDS.

**Actor:** Initiating Gateway

430

**Role:** Services the stored query by initiating transactions with a selected set of Responding Gateways, Document Registries or other appropriate systems.

## Volume 2b – Transactions Part B

435 *Add Section 3.62*

### 3.62 Remove Metadata

440 This section corresponds to Transaction [ITI-62] of the IHE ITI Technical Framework. The Remove Metadata transaction is used by a Document Administrator to submit a list of entryUUID attributes identifying the metadata objects to be removed from a Document Registry including Submission Set, Document Entry, Folder, and Association objects.

#### 3.62.1 Scope

The Remove Metadata transaction passes a Remove Metadata Request from a Document Administrator to a Document Registry.

#### 3.62.2 Actor Roles

445 The Roles in this transaction are defined in the following table and may be played by the actors shown here:

**Table 3.62.2-1: Actor Roles**

<b>Actor:</b>	Document Administrator
<b>Role:</b>	Issues the request to remove one or more metadata objects from a system.
<b>Actor:</b>	Document Registry
<b>Role:</b>	Accepts and processes the request for removing one or more metadata objects from its system.

450 **3.62.3 Referenced Standard**

**Table 3.62.3-1: Referenced Standards**

ebRIM	OASIS/ebXML Registry Information Model v3.0 This model defines the types of metadata and content that can be stored in an ebXML Registry and forms the basis for the Document Sharing metadata model.
ebRS	OASIS/ebXML Registry Services Specifications v3.0 This defines the services and protocols for an ebXML Registry, used as the basis for the XDS Document Registry
See ITI TF-2x: Appendix V for other referenced standards for SOAP encoding.	

See ITI TF-3: 4.2 for other referenced standards for metadata element encoding.

### 3.62.4 Interaction Diagram

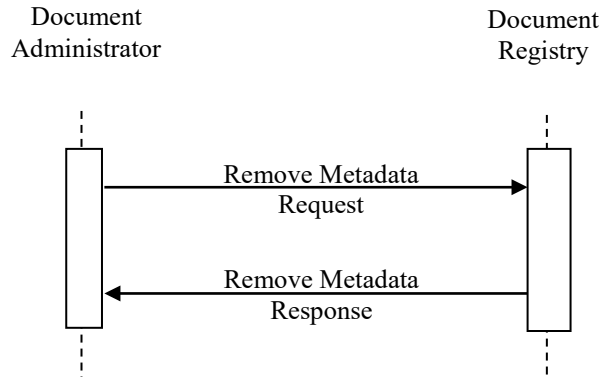

455

#### 3.62.4.1 Remove Metadata Request

The Remove Metadata Request message is used to request the removal of one or more metadata objects from a Document Registry.

##### 460 3.62.4.1.1 Trigger Events

The Document Administrator has identified a list of metadata objects to be removed from a Document Registry either through the use of one or more Registry Stored Query [ITI-18] transactions or the Document Administrator's own internal data. This list may contain metadata objects that reference more than one patient identifier.

465 When removing metadata, the Document Administrator is responsible for ensuring that the Document Registry is left in a consistent state; a state that could be reached through IHE-defined submission transactions only.

##### 3.62.4.1.2 Message Semantics

470 The Remove Documents Request message shall use SOAP 1.2. Implementers of this transaction shall comply with all requirements described in: ITI TF-2x: Appendix V: Web Services for IHE Transactions.

XML namespace prefixes used in text and examples below are for informational purposes only and are documented in ITI TF-2x: Appendix V, Table V.2.4-1.

The requirements for the request message are as follows:

- 475     • the Content-Type HTTP header shall have an action parameter with the value  
urn:ihe:iti:2010:DeleteDocumentSet
- the <wsa:Action/> SOAP element shall contain the value  
urn:ihe:iti:2010:DeleteDocumentSet
- 480     • the <soap12:Body> SOAP element shall contain one <lcm:RemoveObjectsRequest/>  
element
- the <lcm:RemoveObjectsRequest/> element shall contain one <rim:ObjectRefList/>  
element.
- the <rim:ObjectRefList/> element shall contain one or more <rim:ObjectRef/> elements,  
each one containing the entryUUID of an individual metadata object that the Document  
485     Administrator wants removed from the Document Registry. The metadata objects may  
belong to more than one patient.

Note: Requirements for the HTTP Content-Type Header and SOAP Action element reflect the historical name for this transaction.

The following components of the <rs:RemoveObjectsRequest/> shall not be used:

- 490     • <rim:AdhocQuery/> - Object removal is specified only by using <rim:ObjectRefList/>.
- <lcm:RemoveObjectsRequest/@deletionScope/> - The behavior specified for this  
attribute in the ebRS standard is not currently supported in IHE profiles.

A full XML Schema Document for the RDM Profile is available online on the IHE FTP site, see ITI TF-2x: Appendix W.

495     Below is an example of the SOAP Body for a Remove Metadata Request message:

```

<soap12:Body>
  <lcm:RemoveObjectsRequest xmlns:lcm="urn:oasis:names:tc:ebxml-regrep:xsd:lcm:3.0">
    <rim:ObjectRefList xmlns:rim="urn:oasis:names:tc:ebxml-regrep:xsd:rim:3.0">
      <rim:ObjectRef id="urn:uuid:b2632452-1de7-480d-94b1-c2074d79c871"/>
      <rim:ObjectRef id="urn:uuid:b2632df2-1de7-480d-1045-c2074d79aabd"/>
      <rim:ObjectRef id="urn:uuid:b2632132-1de7-480d-88bd-c2074d79009b"/>
      <rim:ObjectRef id="urn:uuid:b2632cd2-1de7-480d-108c-c2074d797777"/>
    </rim:ObjectRefList>
  </lcm:RemoveObjectsRequest>
</soap12:Body>
```

### 3.62.4.1.3 Expected Actions

Upon receipt of a Remove Metadata Request message, the Document Registry shall process the request.

- 500     If a failure is detected during processing, the Document Registry shall return an error response to the Document Administrator; otherwise, the Document Registry shall return a success response to the Document Administrator. The various exception conditions and possible error messages are given in ITI TF-3: 4.2.4 Success and Error Reporting.

The Document Registry shall be capable of accepting a submission containing requests to remove multiple metadata objects.

505 A Document Registry shall process the received message as follows:

For each <rim:ObjectRef/>, the Document Registry shall:

- Verify the entryUUID is found. If a received value is not known to the system, the Document Registry shall generate and return an UnresolvedReferenceException error.
- Remove the identified metadata object.
- 510 • At the conclusion of the transaction, verify the entryUUID is not referenced by other metadata objects held by the Document Registry. If a metadata object contained in the request remains referenced, the Document Registry shall generate and return a ReferencesExistException error.

The Document Registry is responsible for verifying metadata integrity and consistency.

515 If any error is encountered during processing, the system shall rollback all changes and return the system back to its prior state before the transaction.

If successful, the Document Registry no longer allows the requested metadata objects to be discovered.

### **3.62.4.2 Remove Metadata Response**

520 The Document Registry shall send a Remove Metadata Response message when the processing of a Remove Metadata Request is complete.

#### **3.62.4.2.1 Trigger Events**

The request message has been received and processed by the Document Registry.

#### **3.62.4.2.2 Message Semantics**

525 The Remove Metadata Response message shall use SOAP 1.2. Implementers of this transaction shall comply with all requirements described in: ITI TF-2x: Appendix V: Web Services for IHE Transactions.

530 The Remove Metadata Response message shall carry the status of the requested operation. If the requested operation fails, the response message shall carry at least one error message. The conditions of failure and possible error messages are given in ITI TF-3: 4.2.4 Error Reporting.

XML namespace prefixes used in text and in examples below are for informational purposes only and are documented in ITI TF-2x: Appendix V, Table 2.4-1.

The requirements for the response message are:

- the Content-Type HTTP header shall have an action parameter with the value urn:ihe:iti:2010>DeleteDocumentSetResponse
- 535

- the <wsa:Action/> SOAP element shall contain the value urn:ihe:iti:2010>DeleteDocumentSetResponse
- the <soap12:Body/> SOAP element shall contain one <rs:RegistryResponse/> element

540 Note: Requirements for the HTTP Content-Type Header and SOAP Action element reflect the historical name for this transaction.

The rs:RegistryResponse/@status attribute provides the overall status of the request. It shall contain one of two values:

urn:oasis:names:tc:ebxml-regrep:ResponseStatusType:Success

545 urn:oasis:names:tc:ebxml-regrep:ResponseStatusType:Failure

If an error occurs when removing a metadata object, then a rs:RegistryResponse/rs:RegistryErrorList/rs:RegistryError element shall be returned in the response with:

- @severity is urn:oasis:names:tc:ebxml-regrep:ErrorSeverityType:Error.
  - @errorCode contains an error code from ITI TF-3: Table 4.2.4.1-2.
  - @codeContext contains the error message and the entryUUID for the object that caused the error.
- 550

See ITI TF-3: 4.2.4.1 for examples of response messages.

### 3.62.4.2.3 Expected Actions

555 If a successful response is received, the metadata objects were successfully removed and the transaction is complete. If an error response was received, additional manual steps may be required by the Document Administrator to determine the cause and remediation of the error.

### 3.62.5 Security Considerations

560 The Remove Metadata [ITI-62] transaction is intended for administrative maintenance on patient-related metadata stored in the Document Registry. Relevant XDS Affinity Domain security considerations are discussed in the XDS Security Considerations (see ITI TF-1: 10.7). It is recommended that the Remove Metadata [ITI-62] transaction be associated with a SAML assertion as described in the ITI XUA Profile (see ITI TF-1:13).

#### 3.62.5.1 Security Audit Record Considerations

565 The Remove Metadata transaction is a PHI-Export event as defined in ITI TF-2a: Table 3.20.4.1.1.1-1 with exceptions outlined in the following two sections.

This transaction may be recorded as an individual event for each object contained within the Remove Metadata transaction or multiple objects for the same patient may be heuristically combined into a single event when the active participants and patient identifier is the same or not



570 known, and the time difference is considered insignificant. This may be done in order to reduce the volume of audit records. Audit records for this transaction may also contain references to metadata objects that may have been associated with more than one patient identifier. The heuristics for this combination are not specified by IHE.

575

**3.62.5.1.1.1 Document Administrator audit message**

	Field Name	Opt	Value Constraints
<b>Event</b> AuditMessage/ EventIdentification	EventID	M	EV(110110, DCM, "Patient Record")
	EventActionCode	M	"D" (Delete)
	<i>EventDateTime</i>	U	<i>not specialized</i>
	<i>EventOutcomeIndicator</i>	U	<i>not specialized</i>
	EventTypeCode	M	EV("ITI-62", "IHE Transactions", "Remove Metadata")
Source (Document Administrator) (1)			
Human Requestor (0..n)			
Destination (Document Registry) (1)			
Audit Source (Document Administrator) (1)			
Patient (0..n)			
Document Entry/Submission Set/Folder/Association (1..n) ( <i>one for each object removed-see combining rules above</i> )			

Where:

<b>Source</b> AuditMessage/ ActiveParticipant	UserID	U	<i>not specialized</i>
	AlternativeUserID	M	The process ID as used within the local operating system in the local system logs.
	<i>UserName</i>	U	<i>not specialized</i>
	<i>UserIsRequestor</i>	U	<i>not specialized</i>
	RoleIDCode	M	EV(110153, DCM, "Source")
	NetworkAccessPointTypeCode	M	"1" for machine (DNS) name, "2" for IP address
	NetworkAccessPointID	M	The machine name or IP address.

<b>Human Requestor (if known)</b> AuditMessage/ ActiveParticipant	UserID	M	Identity of the human that initiated the transaction.
	<i>AlternativeUserID</i>	U	<i>not specialized</i>
	<i>UserName</i>	U	<i>not specialized</i>
	<i>UserIsRequestor</i>	U	<i>not specialized</i>
	RoleIDCode	M	Access Control role(s) the user holds that allows this transaction.
	<i>NetworkAccessPointTypeCode</i>	U	<i>not specialized</i>
	<i>NetworkAccessPointID</i>	U	<i>not specialized</i>

<b>Destination</b> AuditMessage/ ActiveParticipant	UserID	M	SOAP endpoint URI.
	<i>AlternativeUserID</i>	U	<i>not specialized</i>
	<i>UserName</i>	U	<i>not specialized</i>
	<i>UserIsRequestor</i>	U	<i>not specialized</i>
	RoleIDCode	M	EV(110152, DCM, "Destination")
	NetworkAccessPointTypeCode	M	"1" for machine (DNS) name, "2" for IP address
	NetworkAccessPointID	M	The machine name or IP address.

580

<b>Audit Source</b> <small>AuditMessage/AuditSourceIdentification</small>	<i>AuditSourceID</i>	U	<i>not specialized</i>
	<i>AuditEnterpriseSiteID</i>	U	<i>not specialized</i>
	<i>AuditSourceTypeCode</i>	U	<i>not specialized</i>

<b>Patient (if known)</b> <small>AuditMessage/ParticipantObjectIdentification</small>	<i>ParticipantObjectTypeCode</i>	M	“1” (Person)
	<i>ParticipantObjectTypeCodeRole</i>	M	“1” (Patient)
	<i>ParticipantObjectDataLifeCycle</i>	U	<i>not specialized</i>
	<i>ParticipantObjectIDTypeCode</i>	U	<i>not specialized</i>
	<i>ParticipantObjectSensitivity</i>	U	<i>not specialized</i>
	<i>ParticipantObjectID</i>	M	The patient ID in HL7 CX format.
	<i>ParticipantObjectName</i>	U	<i>not specialized</i>
	<i>ParticipantObjectQuery</i>	U	<i>not specialized</i>
<i>ParticipantObjectDetail</i>	U	<i>not specialized</i>	

<b>Document Entry Submission Set Folder Association</b> <small>AuditMessage/ParticipantObjectIdentification</small>	<i>ParticipantObjectTypeCode</i>	M	“2” (System object)
	<i>ParticipantObjectTypeCodeRole</i>	M	“3” (Report)
	<i>ParticipantObjectDataLifeCycle</i>	U	<i>not specialized</i>
	<i>ParticipantObjectIDTypeCode</i>	M	The Document Administrator shall include one of these values in accordance with the specific object being removed: EV(“urn:uuid:7edca82f-054d-47f2-a032-9b2a5b5186c1”, “IHE XDS Metadata”, “document entry object type”) EV(“urn:uuid:34268e47-fdf5-41a6-ba33-82133c465248”, “IHE XDS Metadata”, “on-demand document entry object type”) EV(“urn:uuid:a54d6aa5-d40d-43f9-88c5-b4633d873bdd”, “IHE XDS Metadata”, “submission set classification node”) EV(“urn:uuid:d9d542f3-6cc4-48b6-8870-ea235fbc94c2”, “IHE XDS Metadata”, “folder classification node”) EV(“urn:oasis:names:tc:ebxml-regrep:AssociationType:HasMember”, “IHE XDS Metadata”, “has-member association type”) EV(“urn:ihe:iti:2007:AssociationType:RPLC”, “IHE XDS Metadata”, “replacement relationship association type”) EV(“urn:ihe:iti:2007:AssociationType:XFRM”, “IHE XDS Metadata”, “transformation relationship association type”) EV(“urn:ihe:iti:2007:AssociationType:APND”, “IHE XDS Metadata”, “append relationship association type”) EV(“urn:ihe:iti:2007:AssociationType:XFRM_RPLC”, “IHE XDS Metadata”, “replace-transformation relationship association type”) EV(“urn:ihe:iti:2007:AssociationType:signs”, “IHE XDS Metadata”, “digital signature relationship association type”) EV(“urn:ihe:iti:2010:AssociationType:IsSnapshotOf”, “IHE XDS Metadata”, “is-snapshot relationship association type”)
	<i>ParticipantObjectSensitivity</i>	U	<i>not specialized</i>
	<i>ParticipantObjectID</i>	M	The entryUUID of the metadata object being removed.
	<i>ParticipantObjectName</i>	U	<i>not specialized</i>
	<i>ParticipantObjectQuery</i>	U	<i>not specialized</i>
	<i>ParticipantObjectDetail</i>	U	<i>not specialized</i>

## 3.62.4.2.4.2 Document Registry audit message

	Field Name	Opt	Value Constraints
<b>Event</b> AuditMessage/ EventIdentification	EventID	M	EV(110110, DCM, "Patient Record")
	EventActionCode	M	"D" (Delete)
	<i>EventDateTime</i>	U	<i>not specialized</i>
	<i>EventOutcomeIndicator</i>	U	<i>not specialized</i>
	EventTypeCode	M	EV("ITI-62", "IHE Transactions", "Remove Metadata")
Source (Document Administrator) (1)			
Destination (Document Registry) (1)			
Audit Source (Document Registry) (1)			
Patient (0..n)			
Document Entry/Submission Set/Folder/Association (1..n) ( <i>one for each object removed-see combining rules above</i> )			

## Where:

	Field Name	Opt	Value Constraints
<b>Source</b> AuditMessage/ ActiveParticipant	UserID	U	<i>not specialized</i>
	AlternativeUserID	U	<i>not specialized</i>
	<i>UserName</i>	U	<i>not specialized</i>
	<i>UserIsRequestor</i>	U	<i>not specialized</i>
	RoleIDCode	M	EV(110153, DCM, "Source")
	NetworkAccessPointTypeCode	M	"1" for machine (DNS) name, "2" for IP address
	NetworkAccessPointID	M	The machine name or IP address.

	Field Name	Opt	Value Constraints
<b>Destination</b> AuditMessage/ ActiveParticipant	UserID	M	SOAP endpoint URI
	AlternativeUserID	M	The process ID as used within the local operating system in the local system logs.
	<i>UserName</i>	U	<i>not specialized</i>
	<i>UserIsRequestor</i>	U	<i>not specialized</i>
	RoleIDCode	M	EV(110152, DCM, "Destination")
	NetworkAccessPointTypeCode	M	"1" for machine (DNS) name, "2" for IP address
	NetworkAccessPointID	M	The machine name or IP address.

585

	Field Name	Opt	Value Constraints
<b>Audit Source</b> AuditMessage/ AuditSourceIdentification	<i>AuditSourceID</i>	U	<i>not specialized</i>
	<i>AuditEnterpriseSiteID</i>	U	<i>not specialized</i>
	<i>AuditSourceTypeCode</i>	U	<i>not specialized</i>

	Field Name	Opt	Value Constraints
<b>Patient (if known)</b> AuditMessage/ ParticipantObjectIdentification	ParticipantObjectTypeCode	M	"1" (person)
	ParticipantObjectTypeCodeRole	M	"1" (patient)
	<i>ParticipantObjectDataLifeCycle</i>	U	<i>not specialized</i>
	<i>ParticipantObjectIDTypeCode</i>	U	<i>not specialized</i>
	<i>ParticipantObjectSensitivity</i>	U	<i>not specialized</i>
	ParticipantObjectID	M	the patient ID in HL7 CX format.

IHE ITI Technical Framework Supplement – Remove Metadata and Documents (RMD)

	<i>ParticipantObjectName</i>	<i>U</i>	<i>not specialized</i>
	<i>ParticipantObjectQuery</i>	<i>U</i>	<i>not specialized</i>
	<i>ParticipantObjectDetail</i>	<i>U</i>	<i>not specialized</i>

<b>Document Entry Submission Set Folder Association</b> <small>AuditMessage/ ParticipantObjectIdentification</small>	ParticipantObjectTypeCode	M	“2” (System object)
	ParticipantObjectTypeCodeRole	M	“3” (Report)
	ParticipantObjectDataLifeCycle	<i>U</i>	<i>not specialized</i>
	ParticipantObjectIDTypeCode	M	<p>The Document Registry shall include one of these values in accordance with the specific object being removed:</p> <p>EV(“urn:uuid:7edca82f-054d-47f2-a032-9b2a5b5186c1”, “IHE XDS Metadata”, “document entry object type”)</p> <p>EV(“urn:uuid:34268e47-fdf5-41a6-ba33-82133c465248”, “IHE XDS Metadata”, “on-demand document entry object type”)</p> <p>EV(“urn:uuid:a54d6aa5-d40d-43f9-88c5-b4633d873bdd”, “IHE XDS Metadata”, “submission set classification node”)</p> <p>EV(“urn:uuid:d9d542f3-6cc4-48b6-8870-ea235fbc94c2”, “IHE XDS Metadata”, “folder classification node”)</p> <p>EV(“urn:oasis:names:tc:ebxml-regrep:AssociationType:HasMember”, “IHE XDS Metadata”, “has-member association type”)</p> <p>EV(“urn:ihe:iti:2007:AssociationType:RPLC”, “IHE XDS Metadata”, “replacement relationship association type”)</p> <p>EV(“urn:ihe:iti:2007:AssociationType:XFRM”, “IHE XDS Metadata”, “transformation relationship association type”)</p> <p>EV(“urn:ihe:iti:2007:AssociationType:APND”, “IHE XDS Metadata”, “append relationship association type”)</p> <p>EV(“urn:ihe:iti:2007:AssociationType:XFRM_RPLC”, “IHE XDS Metadata”, “replace-transformation relationship association type”)</p> <p>EV(“urn:ihe:iti:2007:AssociationType:signs”, “IHE XDS Metadata”, “digital signature relationship association type”)</p> <p>EV(“urn:ihe:iti:2010:AssociationType:IsSnapshotOf”, “IHE XDS Metadata”, “is-snapshot relationship association type”)</p>
	<i>ParticipantObjectSensitivity</i>	<i>U</i>	<i>not specialized</i>
	ParticipantObjectID	M	The entryUUID of the metadata object being removed.
	<i>ParticipantObjectName</i>	<i>U</i>	<i>not specialized</i>
	<i>ParticipantObjectQuery</i>	<i>U</i>	<i>not specialized</i>
<i>ParticipantObjectDetail</i>	<i>U</i>	<i>not specialized</i>	

## Volume 2c – Transactions Part C

*Add new Section 3.Y*

### 3.Y1 Remove Documents

595 This section corresponds to Remove Documents transaction [ITI-Y1] of the IHE ITI Technical Framework. This transaction is used to remove one or more stored documents from a Document Repository.

#### 3.Y1.1 Scope

600 The Remove Documents transaction passes a Remove Documents Request from a Document Administrator to a Document Repository.

#### 3.Y1.2 Actor Roles

The Roles in this transaction are defined in the following table and may be played by the actors shown here:

605

**Table 3.Y1.2-1: Actor Roles**

<b>Actor(s):</b>	Document Administrator
<b>Role:</b>	Issues the request to remove one or more documents from a system.
<b>Actor(s):</b>	Document Repository
<b>Role:</b>	Accepts and processes the request for removing one or more documents from its system.

#### 3.Y1.3 Referenced Standard

**Table 3.Y1.3-1: Referenced Standards**

ebRIM	OASIS/ebXML Registry Information Model v3.0 This model defines the types of metadata and content that can be stored in an ebXML Registry and forms the basis for the Document Sharing metadata model.
ebRS	OASIS/ebXML Registry Services Specifications v3.0 This defines the services and protocols for an ebXML Registry, used as the basis for the XDS Document Registry
See ITI TF-2x: Appendix V for other referenced standards for SOAP encoding.	

See ITI TF-3: 4.2 for other referenced standards for metadata element encoding.

### 610 3.Y1.4 Interaction Diagram

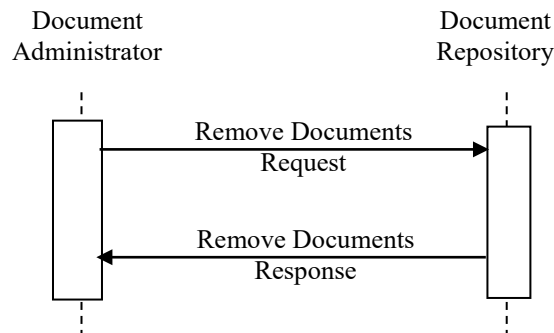

#### 3.Y1.4.1 Remove Documents Request

615 The Remove Documents Request message is used to request the removal of one or more documents from a Document Repository.

##### 3.Y1.4.1.1 Trigger Events

620 The Document Administrator has identified one or more documents to be removed from a Document Repository. It is recommended that prior to initiation of this transaction the Document Administrator has ensured that the document's metadata is no longer discoverable from the Document Registry.

##### 3.Y1.4.1.2 Message Semantics

The Remove Documents Request message shall use SOAP 1.2. Implementers of this transaction shall comply with all requirements described in: ITI TF-2x: Appendix V: Web Services for IHE Transactions.

625 XML namespace prefixes used in text and examples below are for informational purposes only and are documented in ITI TF-2x: Appendix V, Table V.2.4-1.

The requirements for the request message are as follows:

- the Content-Type HTTP header shall have an action parameter with the value `urn:ihe:iti:2017:RemoveDocuments`

- 630
- the <wsa:Action/> SOAP element shall contain the value urn:ihe:iti:2017:RemoveDocuments
  - the <soap12:Body> SOAP element shall contain one <rmd:RemoveDocumentsRequest/> element
  - the <rmd:RemoveDocumentsRequest/> element shall contain one or more <xds:DocumentRequest/> elements, each one representing an individual document that the Document Administrator wants removed from the Document Repository.
- 635

Each <xds:DocumentRequest/> element contains:

- A required <xds:RepositoryUniqueId/> element that identifies the repository from which the document will be removed. This value corresponds to XSDSDocumentEntry.repositoryUniqueId.
  - A required <xds:DocumentUniqueId/> element that identifies the document within the repository. This value corresponds to XSDSDocumentEntry.uniqueId.
- 640

A full XML Schema Document for the RMD Profile types is available online on the IHE FTP site, see ITI TF-2x: Appendix W.

- 645 Below is an example of the SOAP Body for a Remove Documents Request message:

```
<soap12:Body>
  <rmd:RemoveDocumentsRequest
    xmlns:rmd="urn:ihe:iti:rmd:2017"
    xmlns:xds="urn:ihe:iti:xds-b:2007">
    <xds:DocumentRequest>
      <xds:RepositoryUniqueId>1.3.6.1.4.1000</xds:RepositoryUniqueId>
      <xds:DocumentUniqueId>1.3.6.1.4.2300</xds:DocumentUniqueId>
    </xds:DocumentRequest>
    <xds:DocumentRequest>
      <xds:RepositoryUniqueId>1.3.6.1.4.1000</xds:RepositoryUniqueId>
      <xds:DocumentUniqueId>1.3.6.1.4.2301</xds:DocumentUniqueId>
    </xds:DocumentRequest >
  </rmd:RemoveDocumentsRequest>
</soap12:Body>
```

### 3.Y1.4.1.3 Expected Actions

Upon receipt of a Remove Documents Request message, the Document Repository shall process the request.

- 650 If a failure is detected during processing, the Document Repository shall return an error response to the Document Administrator; otherwise, the Document Repository shall return either a success or partial success response to the Document Administrator. The various exception conditions and possible error or warning messages are given in ITI TF-3: 4.2.4 Success and Error Reporting.

- 655 The Document Repository shall be capable of accepting a submission containing a request to remove multiple documents.



A Document Repository shall process the received message as follows:

For each <xds:DocumentRequest/>, the Document Repository shall:

- 660 • Verify the RepositoryUniqueId element. If a received value differs from the value known by the system, the Document Repository shall generate and return an XDSUnknownRepositoryId error.
- Remove the document identified by the value received in the DocumentUniqueId element.
  - If the document cannot be located, the Document Repository shall generate and return an XDSDocumentUniqueIdError error.
  - 665 • If the document is located but cannot be removed, the Document Repository shall generate and return an XDSRepositoryError error.

### 3.Y1.4.2 Remove Documents Response

The Document Administrator shall send a Remove Documents Response message when the processing of a Remove Documents Request is complete.

#### 670 3.Y1.4.2.1 Trigger Events

The request message has been received and processed by the Document Repository.

#### 3.Y1.4.2.2 Message Semantics

675 The Remove Document Response message shall use SOAP 1.2. Implementers of this transaction shall comply with all requirements described in: ITI TF-2x: Appendix V: Web Services for IHE Transactions.

The Remove Documents Response message shall carry the status of the requested operation. If the requested operation partially succeeds or fails, the response message shall carry at least one error message. The conditions of failure and possible warning and error messages are given in ITI TF-3: 4.2.4 Error Reporting.

680 XML namespace prefixes used in the text and examples below are for informational purposes only and are documented in ITI TF-2x: Appendix V, Table 2.4-1.

The requirements for the response message are:

- the Content-Type HTTP header shall have an action parameter with the value urn:ihe:iti:2017:RemoveDocumentsResponse
- 685 • the <wsa:Action> SOAP element shall contain the value urn:ihe:iti:2017:RemoveDocumentsResponse
- the <soap12:Body> SOAP element shall contain one <rs:RegistryResponse> element

The `rs:RegistryResponse/@status` attribute provides the overall status of the request. It shall contain one of the following values:

- 690     • If all documents in the request were able to be removed successfully, the Document Repository shall set the status equal to `urn:oasis:names:tc:ebxml-regrep:ResponseStatusType:Success`.
- 695     • If only some of the documents in the request were able to be removed successfully, then the Document Repository shall set the status equal to `urn:ihe:iti:2007:ResponseStatusType:PartialSuccess`.
- 700     • If all documents in the request failed to be removed, then the Document Repository shall set the status equal to `urn:oasis:names:tc:ebxml-regrep:ResponseStatusType:Failure`.

If an error is reported when removing a document, then a `rs:RegistryResponse/rs:RegistryErrorList/rs:RegistryError` element shall be returned in the response with:

- 705     • `@severity` is `urn:oasis:names:tc:ebxml-regrep:ErrorSeverityType:Error`.
- 710     • `@errorCode` contains an error code from Table 4.2.4.1-2.
- 715     • `@codeContext` contains the error message with the `DocumentUniqueId` requested for removal.

See ITI TF-3: 4.2.4.1 for examples of response messages.

### 3.Y1.4.2.3 Expected Actions

If a successful response is received, the documents were successfully removed and the transaction is complete. If an error or partial success response was received, additional steps may be required by the Document Administrator to determine the cause and remediation of the error.

### 3.Y1.5 Security Considerations

Relevant XDS Affinity Domain security considerations are discussed in the XDS Security Considerations (see ITI TF-1: 10.7). It is recommended that the Remove Documents [ITI-Y1] transaction be associated with a SAML assertion as described in the ITI XUA Profile (see ITI TF-1:13).

#### 3.Y1.5.1 Audit Record Considerations

The Remove Documents transaction is a PHI-Export event as defined in ITI TF-2a: Table 3.20.4.1.1.1-1 with exceptions outlined in the following two sections.

This transaction may be recorded as an individual event for each document contained within the Remove Documents transaction. Multiple transactions for the same patient may be heuristically combined into a single event when the active participants and patient is the same or not known,

and the time difference is considered insignificant in order to reduce the volume of audit records. The heuristics for this combination are not specified by IHE.

725 If only some of the documents could be removed, the actors involved shall record a “success” audit event for those documents removed successfully and a “failure” audit event for those documents not removed.

### 3.Y1.5.1.1 Document Administrator audit message

	Field Name	Opt	Value Constraints
<b>Event</b> AuditMessage/EventI dentification	EventID	M	EV(110110, DCM, “Patient Record”)
	EventActionCode	M	“D” (Delete)
	EventDateTime	M	not specialized
	EventOutcomeIndicator	M	not specialized
	EventTypeCode	M	EV(“ITI-Y1”, “IHE Transactions”, “Remove Documents”)
Source (Document Administrator) (1)			
Human Requestor (0..n)			
Destination (Document Repository) (1)			
Audit Source (Document Administrator) (1)			
Patient (0..1)			
Document (1..n) ( <i>see combining rules above</i> )			

Where:

	Field Name	Opt	Value Constraints
<b>Source</b> AuditMessage/ActivePa rticipant	UserID	M	SOAP endpoint URI
	AlternativeUserID	M	The process ID as used within the local operating system in the local system logs.
	UserName	U	not specialized
	UserIsRequestor	U	not specialized
	RoleIDCode	M	EV(110153, DCM, “Source”)
	NetworkAccessPointTypeCode	M	“1” for machine (DNS) name, “2” for IP address
	NetworkAccessPointID	M	The machine name or IP address.

	Field Name	Opt	Value Constraints
<b>Human Requestor (if known)</b> AuditMessage/ActivePa rticipant	UserID	M	Identity of the human that initiated the transaction.
	AlternativeUserID	U	not specialized
	UserName	U	not specialized
	UserIsRequestor	U	not specialized
	RoleIDCode	M	Access Control role(s) the user holds that allows this transaction.
	NetworkAccessPointTypeCode	U	not specialized
	NetworkAccessPointID	U	not specialized

730

	Field Name	Opt	Value Constraints
<b>Destination</b> AuditMessage/ActivePa rticipant	UserID	M	SOAP endpoint URI.
	AlternativeUserID	U	not specialized
	UserName	U	not specialized
	UserIsRequestor	U	not specialized

# IHE ITI Technical Framework Supplement – Remove Metadata and Documents (RMD)

	RoleIDCode	M	EV(110152, DCM, “Destination”)
	NetworkAccessPointTypeCode	M	“1” for machine (DNS) name, “2” for IP address
	NetworkAccessPointID	M	The machine name or IP address.

<b>Audit Source</b> AuditSourceIdentification	<i>AuditSourceID</i>	<i>U</i>	<i>not specialized</i>
	<i>AuditEnterpriseSiteID</i>	<i>U</i>	<i>not specialized</i>
	<i>AuditSourceTypeCode</i>	<i>U</i>	<i>not specialized</i>

<b>Patient (if known)</b> AuditMessage/ParticipantObjectIdentification	ParticipantObjectTypeCode	M	“1” (Person)
	ParticipantObjectTypeCodeRole	M	“1” (Patient)
	<i>ParticipantObjectDataLifeCycle</i>	<i>U</i>	<i>not specialized</i>
	<i>ParticipantObjectIDTypeCode</i>	<i>U</i>	<i>not specialized</i>
	<i>ParticipantObjectSensitivity</i>	<i>U</i>	<i>not specialized</i>
	ParticipantObjectID	M	The patient ID in HL7 CX format.
	<i>ParticipantObjectName</i>	<i>U</i>	<i>not specialized</i>
	<i>ParticipantObjectQuery</i>	<i>U</i>	<i>not specialized</i>
	<i>ParticipantObjectDetail</i>	<i>U</i>	<i>not specialized</i>

<b>Document</b> AuditMessage/ParticipantObjectIdentification	ParticipantObjectTypeCode	M	“2” (System object)
	ParticipantObjectTypeCodeRole	M	“3” (Report)
	ParticipantObjectDataLifeCycle	M	“15” (Permanent erasure / Physical destruction)
	<i>ParticipantObjectIDTypeCode</i>	<i>U</i>	<i>not specialized</i>
	<i>ParticipantObjectSensitivity</i>	<i>U</i>	<i>not specialized</i>
	ParticipantObjectID	M	The value of the XDSDocumentEntry.uniqueId.
	ParticipantObjectName	U	not specialized
	ParticipantObjectQuery	U	not specialized
	ParticipantObjectDetail	M	The value of “urn:ihe:iti:xds:2007:repositoryUniqueId” as the value of the attribute type and the value of the repositoryUniqueId as the value of the attribute value. This element is required.

735

## 3.Y1.5.1.2 Document Repository audit message

	Field Name	Opt	Value Constraints
<b>Event</b> AuditMessage/EventIdentification	EventID	M	EV(110110, DCM, "Patient Record")
	EventActionCode	M	"D" (Delete)
	EventDateTime	U	not specialized
	EventOutcomeIndicator	U	not specialized
	EventTypeCode	M	EV("ITI-Y1", "IHE Transactions", "Remove Documents")
Source (Document Administrator) (1)			
Destination (Document Repository) (1)			
Audit Source (Document Repository) (1)			
Patient (0..1)			
Document (1..n) (see combining rules above)			

Where:

<b>Source</b>	Field Name	Opt	Value Constraints
AuditMessage/ActiveParticipant	UserID	M	SOAP endpoint URI
	AlternativeUserID	U	not specialized
	UserName	U	not specialized
	UserIsRequestor	U	not specialized
	RoleIDCode	M	EV(110153, DCM, "Source")
	NetworkAccessPointTypeCode	M	"1" for machine (DNS) name, "2" for IP address
	NetworkAccessPointID	M	The machine name or IP address.

<b>Destination</b>	Field Name	Opt	Value Constraints
AuditMessage/ActiveParticipant	UserID	M	SOAP endpoint URI.
	AlternativeUserID	M	The process ID as used within the local operating system in the local system logs.
	UserName	U	not specialized
	UserIsRequestor	U	not specialized
	RoleIDCode	M	EV(110152, DCM, "Destination")
	NetworkAccessPointTypeCode	M	"1" for machine (DNS) name, "2" for IP address
	NetworkAccessPointID	M	The machine name or IP address.

<b>Audit Source</b>	Field Name	Opt	Value Constraints
AuditMessage/AuditSourceIdentification	AuditSourceID	U	not specialized
	AuditEnterpriseSiteID	U	not specialized
	AuditSourceTypeCode	U	not specialized

740

<b>Patient (if known)</b>	Field Name	Opt	Value Constraints
AuditMessage/ParticipantObjectIdentification	ParticipantObjectTypeCode	M	"1" (Person)
	ParticipantObjectTypeCodeRole	M	"1" (Patient)
	ParticipantObjectDataLifeCycle	U	not specialized
	ParticipantObjectIDTypeCode	U	not specialized
	ParticipantObjectSensitivity	U	not specialized
	ParticipantObjectID	M	The patient ID in HL7 CX format.
	ParticipantObjectName	U	not specialized

# IHE ITI Technical Framework Supplement – Remove Metadata and Documents (RMD)

	<i>ParticipantObjectQuery</i>	<i>U</i>	<i>not specialized</i>
	<i>ParticipantObjectDetail</i>	<i>U</i>	<i>not specialized</i>

<b>Document</b> <small>AuditMessage/ParticipantObjectIdentification</small>	ParticipantObjectTypeCode	M	“2” (System object)
	ParticipantObjectTypeCodeRole	M	“3” (Report)
	ParticipantObjectDataLifeCycle	M	“15” (Permanent erasure / Physical destruction)
	<i>ParticipantObjectIDTypeCode</i>	<i>U</i>	<i>not specialized</i>
	<i>ParticipantObjectSensitivity</i>	<i>U</i>	<i>not specialized</i>
	ParticipantObjectID	M	The value of the XSDDocumentEntry.uniqueId.
	<i>ParticipantObjectName</i>	<i>U</i>	<i>not specialized</i>
	<i>ParticipantObjectQuery</i>	<i>U</i>	<i>not specialized</i>
	ParticipantObjectDetail	M	The value of “urn:ihe:iti:xds:2007:repositoryUniqueid” as the value of the attribute type and the value of the repositoryUniqueid as the value of the attribute value. This element is required.

## Volume 2x-Appendices

745

### Appendix V: Web Services for IHE Transactions

*Editor: Update Table V.2.4-1: XML Namespaces and Prefixes as shown.*

**Table V.2.4-1: XML Namespaces and Prefixes**

Prefix	Namespace	Specification
wSDL (or default)	http://schemas.xmlsoap.org/wSDL/	<a href="#">WSDL 1.1</a> binding for SOAP 1.1 <a href="#">WSDL 1.1 binding for SOAP 1.2</a>
wsoap12	http://schemas.xmlsoap.org/wSDL/soap12/	<a href="#">WSDL 1.1 binding for SOAP 1.2</a>
wsoap11	http://schemas.xmlsoap.org/wSDL/soap/	<a href="#">WSDL 1.1</a> binding for SOAP 1.1
wsoap	Either wsoap11 or wsoap12, depending on context	
wsa	http://www.w3.org/2005/08/addressing	<a href="#">WSA 1.0 - Core</a>
wsaw	http://www.w3.org/2007/05/addressing/metadata	<a href="#">WSA 1.0 - Metadata</a>
soap12	http://www.w3.org/2003/05/soap-envelope	<a href="#">SOAP 1.2</a>
soap11	http://schemas.xmlsoap.org/soap/envelope/	<a href="#">SOAP 1.1</a>
soap	Either soap11 or soap12 depending on context	
HL7	urn:hl7-org:v3	HL7 V3 XML ITS
xsd	http://www.w3.org/2001/XMLSchema	<a href="#">XML Schema</a>
xsi	http://www.w3.org/2001/XMLSchema-instance	<a href="#">XML Schema</a>
lcm	urn:oasis:names:tc:ebxml-regrep:xsd:lcm:3.0	
rim	urn:oasis:names:tc:ebxml-regrep:xsd:rim:3.0	
rs	urn:oasis:names:tc:ebxml-regrep:xsd:rs:3.0	
query	urn:oasis:names:tc:ebxml-regrep:xsd:query:3.0	
xds	urn:ihe:iti:xds-b:2007	
xop	http://www.w3.org/2004/08/xop/include	
<b>rmd</b>	<b><u>urn:ihe:iti:rmd:2017</u></b>	

750

## Volume 3 Cross-Transaction and Content Specifications

The following modifications are made to ITI TF-3: Table 4.2.4.1-2 Error Codes.

Note: The footnote is also updated.

755

Error Code	Discussion	Transaction (See Note 1)
XDSDocumentUniqueIdError	The document associated with the uniqueId is not available. This could be because the document is not available, the requestor is not authorized to access that document or the document is no longer available.	RS, XGR, <b><u>RD</u></b>
XDSUnknownRepositoryId	The repositoryUniqueId value could not be resolved to a valid document repository or the value does not match the repositoryUniqueId.	RS, XGR, <b><u>RD</u></b>
UnresolvedReferenceException	The recipient cannot resolve an entryUUID reference in the transaction	P, R, <b><u>RM</u></b>
<b><u>ReferencesExistException</u></b>	<b><u>The recipient was unable to remove the metadata object because the entryUUID is referenced by an Association.</u></b>	<b><u>RM</u></b>
<b><u>XDSUnreferencedObjectException</u></b>	<b><u>A metadata object is no longer referenced by any Association.</u></b>	<b><u>RM</u></b>



Error Code	Discussion	Transaction (See Note 1)
XDSRegistryError XDSRepositoryError	Internal Error The error codes XDSRegistryError or XDSRepositoryError shall be returned if and only if a more detailed code is not available from this table for the condition being reported. If one of these error codes is returned, the attribute codeContext shall contain details of the error condition that may be implementation-specific	P, R, SQ, XGQ, <b><u>RM</u></b> P, RS, XGR, <b><u>RD</u></b>
XDSRegistryOutOfResources XDSRepositoryOutOfResources	Resources are low.	P, R, SQ, XGQ, <b><u>RM</u></b> P, RS, XGR, <b><u>RD</u></b>

Note 1:

P = Provide and Register-b

R = Register-b

SQ = Stored Query

760

RS = Retrieve Document Set

XGQ = Cross Gateway Query

XGR = Cross Gateway Retrieve

**RM = Remove Metadata**

**RD = Remove Documents**

765

*Editor: Add Table 4.2.4.2-X: [ITI-62] Remove Metadata Responses*

**Table 4.2.4.2-X: [ITI-62] Remove Metadata Responses**

RegistryResponse status	RegistryErrorList element	Result
urn:oasis:names:tc:ebxml-regrep:ResponseStatusType:Success	Will not be present.	All metadata was successfully removed.

RegistryResponse status	RegistryErrorList element	Result
urn:oasis:names:tc:ebxml-regrep:ResponseStatusType:Failure	Present, contains one or more RegistryError elements with error severity.	Metadata was not removed.

770

*Editor: Add Table 4.2.4.2-X: [ITI-Y1] Remove Documents Responses*

**Table 4.2.4.2-X: [ITI-Y1] Remove Documents Responses**

Registry Response status	RegistryErrorList element	Result
urn:oasis:names:tc:ebxml-regrep:ResponseStatusType:Success	Will not be present.	All documents were successfully removed.
urn:ihe:iti:2007:ResponseStatusType:PartialSuccess	Present, contains one or more RegistryError elements. At least one has error severity.	Some documents were successfully removed.
urn:oasis:names:tc:ebxml-regrep:ResponseStatusType:Failure	Present, contains one or more RegistryError elements. All elements will have error severity.	No documents were successfully removed.

775